



Atlas

IED



SOUND



AMPLIFYING EQUIPMENT

1933

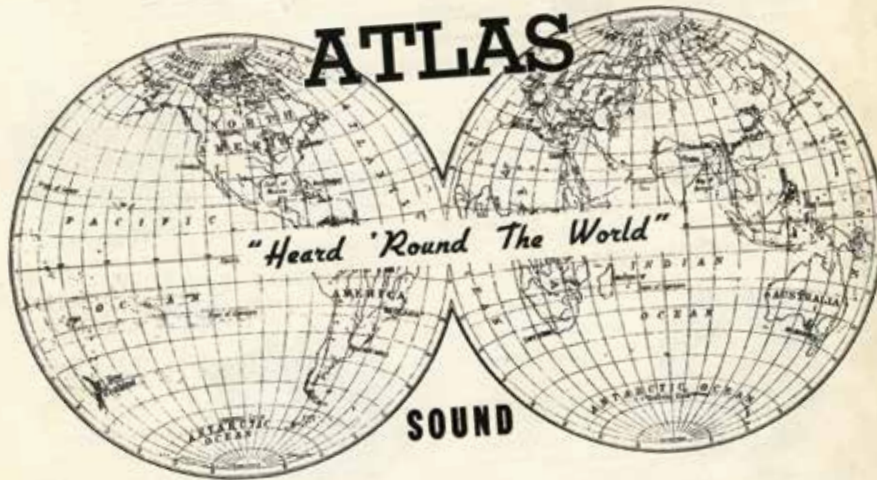

- Parabolic Baffles
- Microphone Stands
- Baffle Stands & Fixtures
- Driver Units
- Exponential Trumpets
- Wall Speaker Enclosures
- Banquet & Desk Stands
- Demountable Baffles
- P. A. Amplifiers
- Field Exciters

Atlas Sound Corporation

FACTORY & GENERAL OFFICE
 1451-39th STREET
 BROOKLYN - N. Y. - U.S.A.

EXPORT DIVISION
 100 VARICK STREET
 New York - N. Y. - U.S.A.

Celebrating 80+ Years of Quality



Loyd Ivey
President / CEO
Mitek Corp

For 80 years Atlas Sound has worked hard to deliver our customers cutting edge solutions that address their needs and the problems they most often encounter on the job. As this mission has continued to drive us, our product offering has become more robust. This year we have further expanded this product offering with several innovative new products that allow us to now be able to provide our customers with almost every component needed for any type job they undertake.

Atlas is still the standard for high quality analog loudspeakers and microphone stands, but did you know that for over 10 years Atlas has been making industry leading IP speakers, or that Atlas has a full line of Time Saving Devices (TSDs) that are designed to solve common problems encountered on site with minimal impact on cost and easy installation? Atlas is no longer the “same old” company that you have known for 80 years. Our current product line including the BlueBridge DSP platform, networkable amplifiers, innovative rack solutions, and other time and money saving solutions has taken Atlas to the next level.

This catalog is designed to show you the full breadth of product that Atlas offers and to reinforce that Atlas can supply you with whatever you need to get the job done right. This catalog has been designed to be easy to reference, with specs and features on each product page, and easy to find what you need, with products grouped with like models for easy comparison.

We are honored to be your go to choice for commercial audio solutions and we look forward to helping grow your business today, tomorrow, and in the future.

A handwritten signature in black ink, appearing to read "Loyd Ivey". The signature is stylized and fluid, with a large loop at the end.





New Products 2016



FAP Strategy III Series Ceiling Loudspeakers

Three years of development has produced the next generation in-ceiling loudspeaker mounting solution. Our patent-pending **Safety First Mounting System (SFMS)** ensures the loudspeaker stays secured to the ceiling and does not require a tool to tighten the dog leg style mounting tabs. No more over-torqued mounts cracked by tools. No more rusted screws.

Eliminate both of these primary contributors that lead to falling loudspeakers.



- 70.7V/100V and 8Ω operation
- Improved waveguide provides up to 130° wide-dispersion
- Ported enclosure provides enhanced low-frequency response
- Safety listed to UL1480 and UL2043
- Paint mask, C-ring, tile rails, grille pull and release tool

Model	Size	Type	Power Taps	Frequency Response	Sensitivity (1W/1m)	Dispersion
FAP33T-W	3"	Single Cone	2, 4, 8, 16 W & 6Ω	85Hz - 12kHz	89dB	135°
FAP43T-W	4.5"	Coaxial	4, 8, 16, 32 W & 8Ω	60Hz - 20kHz	90dB	110°
FAP63T-W	6.5"	Coaxial	4, 8, 16, 32 W & 8Ω	50Hz - 20kHz	90dB	130°

FAP43T-W



FAP63T-W

FAP33T-W



SFMS
Safety First Mounting System

FS Series Arena Horn Loudspeakers

The FS Series is designed to deliver exceptional coverage and quality sound in a lightweight and compact all-weather enclosure that can be used in multiple outdoor and indoor installation applications including arenas, gymnasiums, civic centers, and other large venues. The FS Series is available in five models, each designed to provide optimum sound reinforcement. FS Series loudspeakers are constructed using molded linear low-density polyethylene (LLDPE) to create an incredibly strong yet lightweight enclosure. Each model includes a stainless steel U-bracket and fly-points allowing for easy mounting and incorporates an integrated 70.7V transformer with low insertion loss and full frequency response. The transformer is discretely mounted under the rear cover for weather protection. Each long throw model and the subwoofer has power taps up to 200-watts while the single short throw version has power taps up to 100-watts. The cabinet is UV resistant and has a neutral 'battleship' grey finish. These features will allow for years of durability.

- High SPL output and long throw are ideal for arenas, gymnasiums, outdoor stadiums, and pools
- All-weather construction ensures long-term reliability through varying seasons
- Flexible mounting system ensures versatile install mounting angles
- Easy service design allows transducers to be serviced 'in the field' without uninstalling the enclosure from the mount
- Neutral finish blends into any environment



Model	Size	Type	Power Taps	Frequency Response	Sensitivity (1W/1m)	Dispersion
FS12T-66	12"	Long Throw	25, 50, 100, 200 W & 8Ω	80Hz - 18kHz	100dB	65° x 65°
FS12T-99	12"	Long Throw	25, 50, 100, 200 W & 8Ω	80Hz - 18kHz	100dB	90° x 90°
FS12T-94	12"	Long Throw	25, 50, 100, 200 W & 8Ω	80Hz - 18kHz	100dB	90° x 40°
FS12T-BT60	12"	Short Throw	25, 50, 100 W & 8Ω	80Hz - 18kHz	95dB	90° Conical
FS12T-SUB	12"	Subwoofer	25, 50, 100, 200 W & 8Ω	45Hz - 125Hz	101dB	Omni

A-Line Line Array Loudspeakers

The new ALA line array loudspeaker system delivers exceptional performance and contemporary styling for applications requiring excellent speech intelligibility and minimal acoustical impact. These loudspeakers are constructed with an extruded aluminum housing that makes them lightweight and easy to install with contemporary aesthetics. ALA's new transducer configuration accurately reproduces sound to the listener. It incorporates tightly-packed, high-frequency transducers and full-range drivers for full sound spectrum coverage. A dual-purpose integrated pole mount bracket enables the array to be wall mounted for fixed installations or used in portable applications coupled with an A-Line subwoofer. Models are available in either a black or neutral finish.

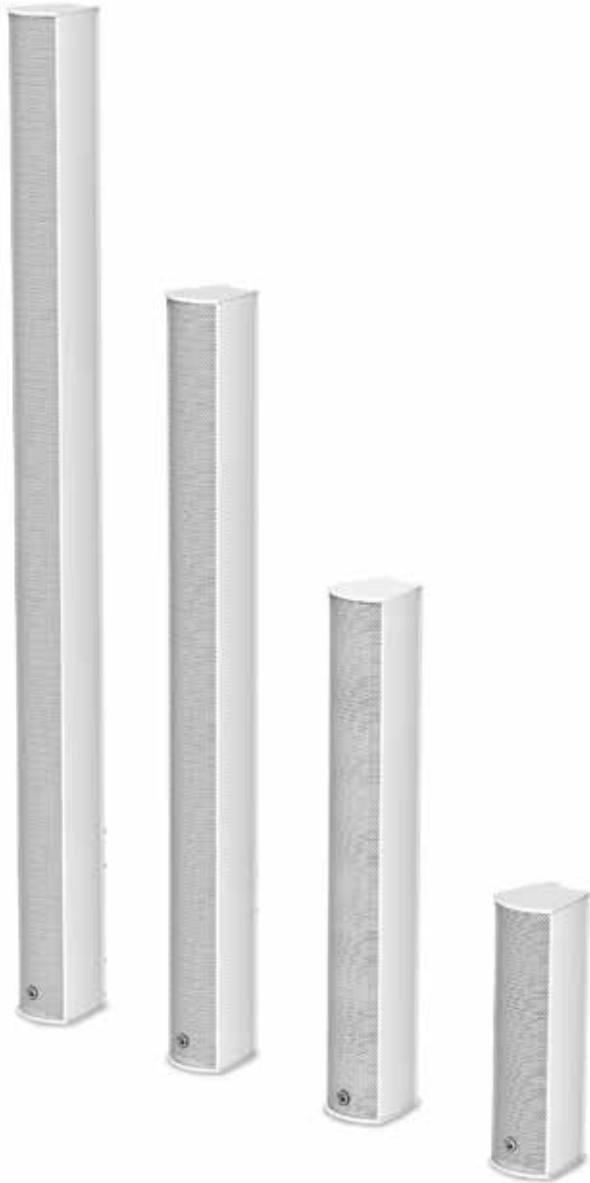

Model	ALA5T(-B)	ALA10T(-B)	ALA15T(-B)	ALA20T(-B)
Impedance	8Ω	8Ω	8Ω	8Ω
70.7V Power Taps	7.5, 15, 30, 60 Watts	7.5, 15, 30, 60 Watts	7.5, 15, 30, 60 Watts	7.5, 15, 30, 60 Watts
Frequency Response	125Hz-20k	125Hz-20k	90Hz-20k	90Hz-20k
Sensitivity (1W/ 1M)	92dB	96dB	96dB	97dB
Vertical Coverage	45°	40°	40°	40°
Horizontal Coverage	135°	135°	135°	135°
Dimensions	16.61" x 4.61" x 5.43"	32.9" x 4.61" x 5.43"	49.37" x 4.61" x 5.43"	65.75" x 4.61" x 5.43"

VoIP Loudspeaker Solutions



Enhancing Unified Communications with Loud and Intelligible Notifications

Now, you have a VoIP loudspeaker that provides intelligible notifications that a phone can not cover such as large areas, noisy spaces, and outdoor environments. AtlasIED is pleased to introduce our next generation VoIP loudspeakers. This new line offers numerous enhancements such as auto-provisioning to simplify integration within your network. You can easily configure our VoIP loudspeakers on your current voice-enabled VLAN, taking advantage of existing Quality of Service (QoS) for network communications stability.

Auto-Registers or Compatible:

- Cisco CUCM infrastructure
- Cisco's Unified Survivable Remote Site Telephony (SRST)
- SIP devices directly to a SIP server
- Fits into your existing WAN environment
- InformaCast and SA-Announce 3rd party notification applications
- Most on-premise or third-party hosted call control applications
- Leverages your legacy analog systems

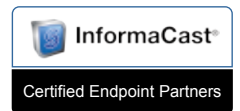

AtlasIED Advantages Include:

- Professional-grade loudspeaker with integrated amplifier
- Accurate speech intelligibility and high-output capability
- Integrated microphone for full-duplex talkback
- Easy installation with one network cable
- Advanced alerting, bell schedules, pre-recorded and scheduled announcements
- Some models with integrated LED display and/or high-output LED flasher
- POE+ enabled
- UL listed

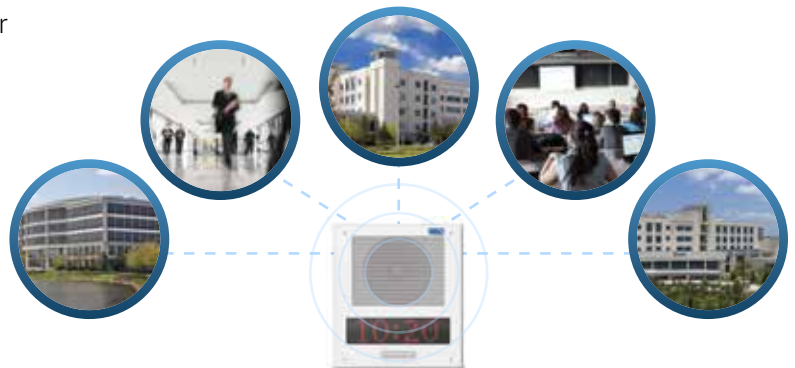

VoIP Solution - System Example

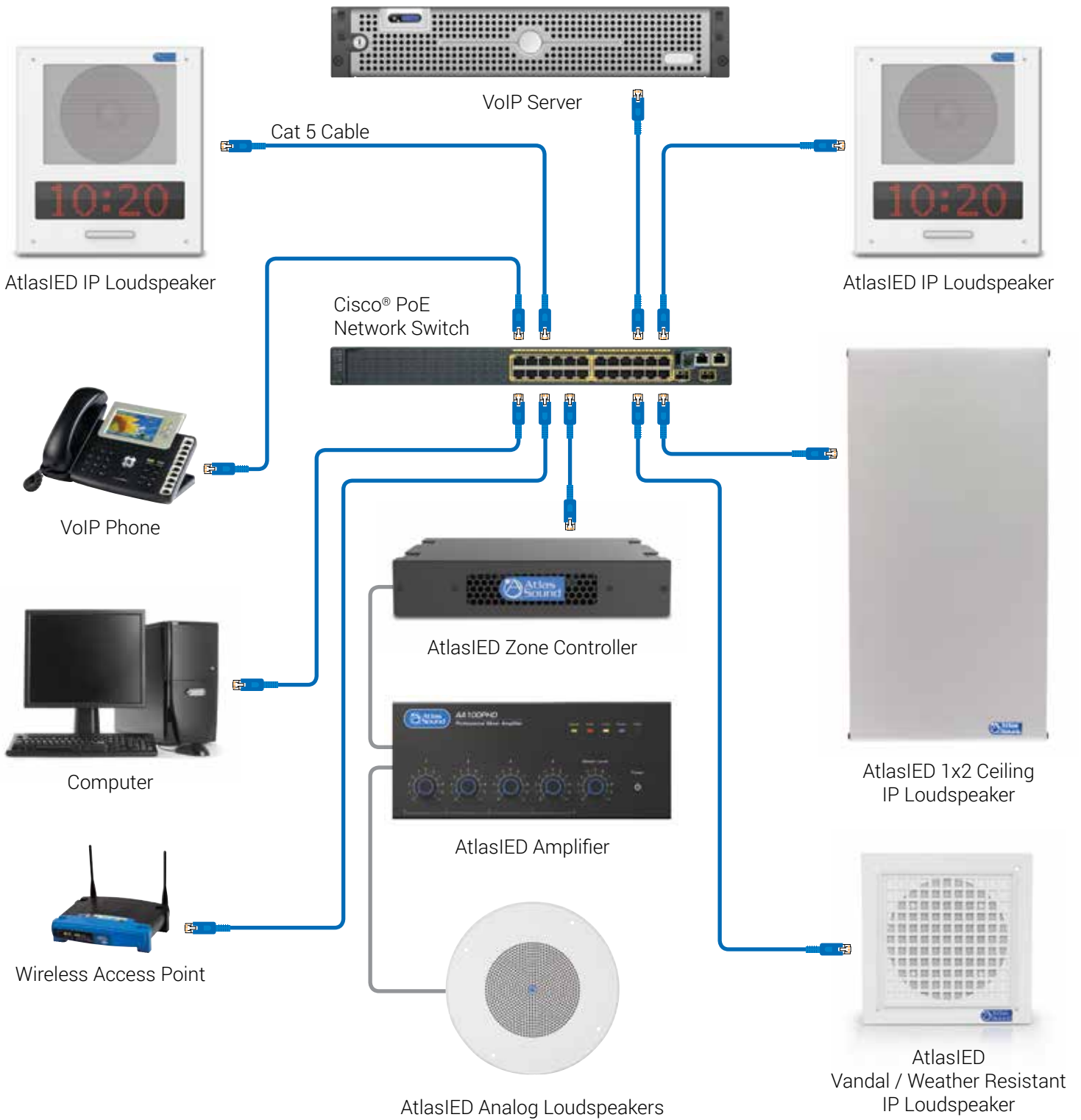

Hydrophobic™ Environmental Treatment

AtlasLED's all new patent-pending

HYDROPHOBIC™ coating protects loudspeakers from water damage in high-humidity and moisture rich environments. Using the power of nanotechnology, the coated surface completely repels humidity and liquids. Any liquid simply rolls off without touching the underlying surface. It prevents water from penetrating loudspeaker cones, even paper, allowing any type of loudspeaker to be used outdoors or in high humidity environments.



Amathophobic™ Environmental Treatment

All new patent-pending **AMATHOPHOBIC™** coating keeps loudspeakers clean and dust-free for years. This innovative nanotechnology, protects grilles, cabinets, and loudspeakers from dirt and dust adhesion, while ensuring ceilings, walls, and outdoor loudspeakers always look as good as new.



AAPHD Multi-Input Mixer Amplifiers

- Three to six input mixer amplifiers
- Available with up to 400W of power into 25V/70V and 4Ω loads
- Patent pending "Push Here Diagnostic®" (PHD) checks connected loudspeaker lines for wiring and load impedance errors
- Remote level control and remote input selection* (RIS) capable
- Balanced and unbalanced inputs
- Input assignable Zone 2 output
- Security cover caps provided

Available Models:

AA30PHD	30 Watts	3 Inputs
AA50PHD	50 Watts	4 Inputs
AA100PHD	100 Watts	4 Inputs
AA200PHD	200 Watts	6 Inputs
AA400PHD	400 Watts	6 Inputs

*AA30PHD Does Not Include RIS Functionality

CE Certified Models

AA50PHD-CE	50 Watts	4 Inputs
AA200PHD-CE	200 Watts	6 Inputs



PHD Diagnostic Test Condition Examples

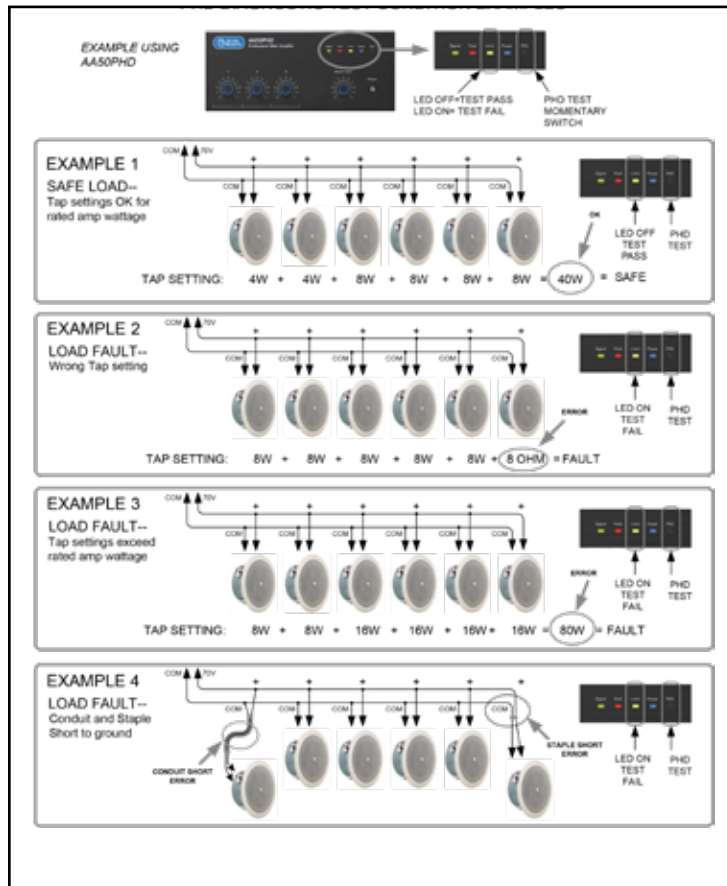

AA200PHD Using Remote Input Selection Wall Plate

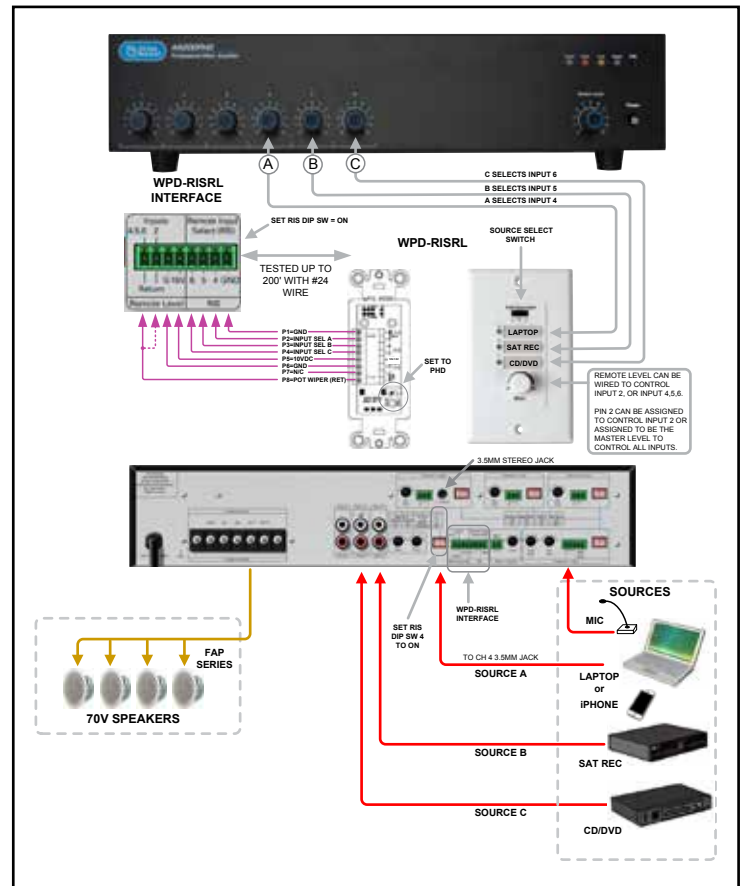

High Power HPA Series Amplifiers

The HPA Series is AtlasIED's line of high-output power amplifiers. These workhorse amplifiers provide worry-free 24/7 operation for any application type or load condition. Each model has two-channels of output that can be configured in 70V, 8Ω, 4Ω, or 2Ω operation. HPA Series models meet Energy Star with less than 1W of power consumption in standby mode. Features include remote turn-on, fault reporting, and a universal power supply that auto senses AC current at both 120VAC and 220VAC enabling global use. An optional Dante™ Card is available for audio systems requiring digital audio networking.



Model	HPA2602	HPA4202
Power 70.7V	2 x 1300 W	2 x 2100 W
Power 8Ω	2 x 800 W	2 x 1200 W
Power 4Ω	2 x 1300 W	2 x 2100 W
Power 2Ω	2 x 1800 W	2 x 2500 W
Power 8Ω Bridged	1 x 2500 W	1 x 3200 W
Power 4Ω Bridged	1 x 3200 W	1 x 4800 W

- Two channels
- 2, 4, 8Ω & 70V operation
- Accessory card slot for available Dante™ network audio card (HPA-DAC2)
- Fault reporting
- Remote turn on
- Balanced inputs
- Stepped attenuators with security cover
- Stereo, bridge, or parallel operating
- Auto sensing 120V/220V AC mains power supply
- Meets Energy Star standards 1W standby mode

Multi-Channel Network DPA Series Amplifiers

The DPA Series is a family of multi-channel power amplifiers featuring integrated digital signal processing and network control. DPA Series amplifiers are available in three models, with the most powerful model delivering 2400W of total power. Each model has flexible output operation for a variety of installation types. It ships as a 2-channel 70V amplifier, but can easily be reconfigured to a 4-channel 4Ω or 3-channel 70V and 4Ω configuration. The internal DSP software is embedded in the amplifier and is accessible via a web user interface and features I/O routing, high and low pass filters, EQ, output level adjustment, delay, and limiter. Assignable control ports for remote level and mute functions are incorporated, along with an accessory card slot for Dante™ Digital Audio or a 4-input analog mixer.

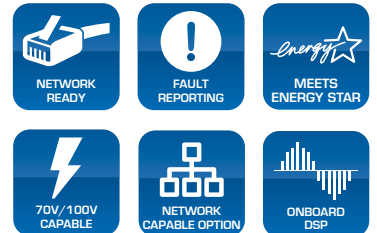

- 2 CH 70.7V (factory default) or 4CH mix impedance operation
- Internal digital signal processing
- Up to 8 inputs
- Assignable control ports for remote level or mute
- **Site Manager Software** enables web control and status of all models on the network
- Accessory card slot for Dante™ (model DPA-DAC4) or analog mixer available
- PC, iOS®, and Android® controllable with priority settings



Site Manager Software



Configuration Page with Metering



User Control Page



Mute, Link, Control Port Assignment Page

Model	Channels	Power per CH 70.7V/100V	Power per CH 4Ω	Power per CH 70.7V/100V & 4Ω
DPA602	4	2 x 300 W	4 x 150 W	1 x 300 W / 2 x 150 W
DPA1202	4	2 x 600 W	4 x 300 W	1 x 600 W / 2 x 300 W
DPA2402	4	2 x 1200 W	4 x 500 W	1 x 1200 W / 2 x 500 W

GLOBALCOM® 5400 Series

The Solution for Smart Building Communication & Mass Notification



GLOBALCOM®



The GLOBALCOM® 5400 Series was designed by our team of dedicated engineers from the ground up to meet the rigorous demands for Mass Notification and Emergency Communications as set forth by the NFPA (UL-2572) and European fire and life safety agencies (EN 54-16). While the 5400 Series is the key element for notification in your crisis management plan, it also excels as the day-to-day communication and paging solution required by the most demanding environments. From airports, subway and transit stations to hospitals, schools, stadiums, government facilities, office buildings and factories, the IED 5400 Series delivers the message clearly and concisely when seconds count.

The GLOBALCOM® 5400 Series is loaded with features that make it easy to use, scalable for any size facility and cost-effective to implement.

Key features include:

- Decentralized architecture using autonomous controllers that communicate to each other via Layer 3
- UL-1711 listed amplifiers for fire protective signaling systems (required by UL-2572)
- EN 54-16 certified components for voice alarm control and indicating equipment
- Complete system supervision and testing from the microphone element to the loudspeaker
- Continuous real-time ambient noise analysis and automatic output level control
- Fully-supervised logic inputs for fire alarm and security system interfaces
- Synchronous visual paging for recorded messages
- Multiple failover and system redundancy options
- Fully-configurable touch screen paging and communications stations
- Integrated VoIP telephone interface
- Works with **DIRECTOR®** for easy-to-produce custom graphical user interfaces
- Complete integration with existing GLOBALCOM® vACS announcement control systems or legacy 500 ACS systems (requires GLOBALCOM® vACS software)



GLOBALCOM® 5400 Series - System Example

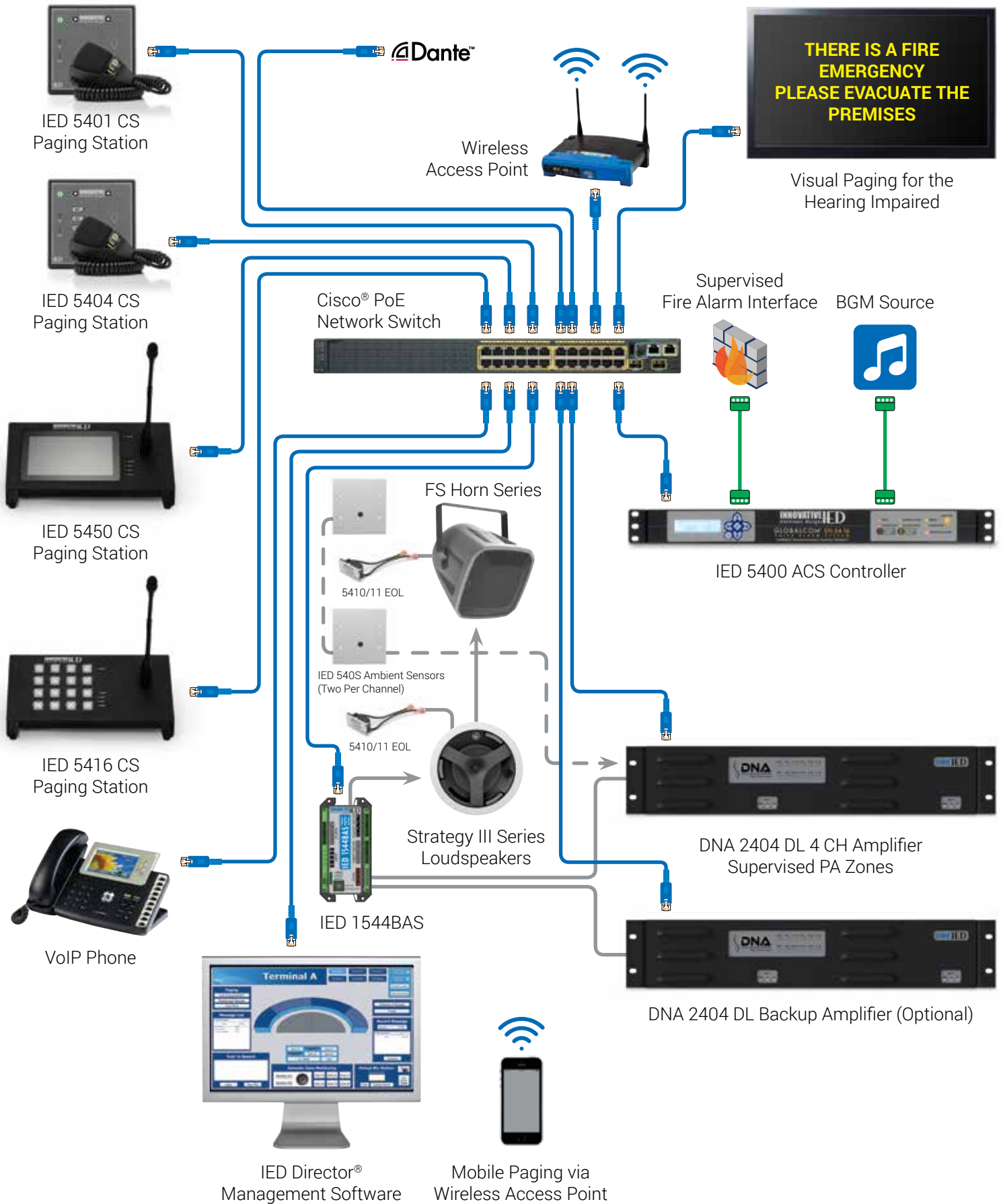

Facility Specific Control Software

DIRECTOR®

DIRECTOR® is a management and operations package that provides a comprehensive application specific interface to any GLOBALCOM® system. The software provides an easily accessible view of your overall system status and makes system operation very easy through an intuitive and fully customizable graphical user interface. DIRECTOR® enables complete system management in complex facilities such as large airports, public transportation systems, industrial campuses or retail centers.



DIRECTOR® can be deployed in a variety of locations throughout a facility and can be customized for any facility layout. The World Trade Center transportation hub, museum, and vehicle security center chose GLOBALCOM® and DIRECTOR® to allow their facility management personnel the ability to easily facilitate messaging and monitoring throughout the complex from a central location.





AtlasIED is the proven enterprise-based communications and emergency solutions leader with over 45 years of experience. We are pleased to introduce our next-generation GCK software application that provides our world-renowned notification technologies in a scalable solution for all business types. Utilizing both Audio over Ethernet (AoE) and Voice over IP (VoIP) protocols simultaneously, GCK provides intelligible audio and flexibility to meet the needs of any environment.



With GCK software solution, you can now unify multiple notification systems and add advanced control & functionality to:



VoIP Loudspeakers



Digital Page Stations



Message Servers



ADA Compliant Displays



VoIP and SIP devices



Analog Systems

All devices under one software platform

With GCK, these devices can now provide improved DAILY communication such as:

- High-Definition Audio for Intelligible Full-Range Playback
- Scheduled Zone Specific Audio and Visual Content
- Record and Playback Live Pages in a Priority Queue
- Full-Duplex Talkback
- ADA Compliant Visual Messaging
- Real-Time Environmental Noise Analysis that Automatically Adjusts Audio Levels Up or Down Based Upon the Ambient Noise
- Speech Privacy and Sound Masking
- System Monitoring and Supervision
- Full Redundancy with Active Failover

During an emergency, GCK stands out as the BEST mass notification and evacuation platform. It allows rapid communications that promote a timely response when crisis happens. Our software solution provides:

- Automated Message Instructions Sent to Emergency Responders Based Upon Defined Protocols
- Zone Specific Message Announcements to Calm and Ensure People
- Simultaneously Broadcast to Multiple Hardwired and Mobile Devices
- Full System Monitoring and Supervision
- Allows Emergency Responders to Launch Alerts and Control the System Locally or Remotely

GCK provides a redundant, supervised, and intelligible solution that will SAVE LIVES WHEN SECONDS COUNT

The perfect collaboration solution for the following Unified Communication Management platforms:
Cisco, Shoretel, Avaya, Astrik, any SIP based or analog PBX

Atlas Sound has been providing high quality audio solutions to the commercial audio industry for 80 years. There are many projects in the market today that require a certain number of products that meet the criteria of the Buy American Act be used. Atlas Sound is proud to offer our integrators and customers over 450 parts that qualify for the Buy American Act that are manufactured or assembled in our Ennix, TX manufacturing facility that boasts over 100,000 square feet of manufacturing space.

The bulk of the space in the facility is dedicated to metal work. Using state of the art equipment, Atlas manufactures equipment racks and metal rack accessories including doors, panels, shelves, drawers, and casters. Other metal products produced in this facility include metal speaker enclosures and speaker baffles for some of our most popular speakers.

Manufacturing in this facility does not stop with metal, Atlas also manufactures or assembles several speakers in the facility as well. Speaker models include sirens like the AS100N, sound masking speakers like the M1000-USA, compression drivers including the PD-30, PD-5VH, and PD60A, and speaker packages like the UHT and UKT life safety series models. Navigating and bidding jobs with Buy American Act requirements can be challenging, but Atlas is here to help its customers offer great solutions that meet these requirements while delivering the high quality and performance expected from Atlas. See the below list for a full list of Atlas parts that meet Buy American Act requirements.

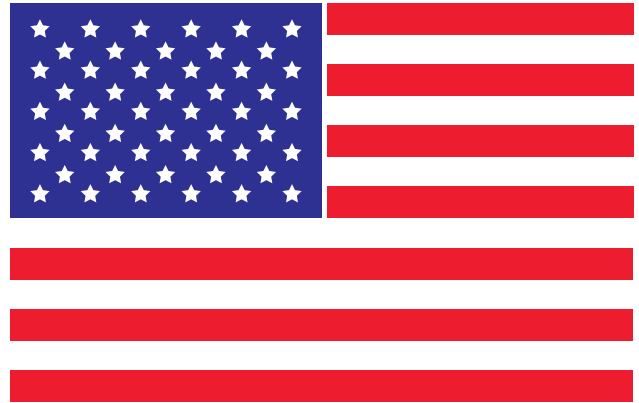

121-18	61	235-25	57	62-8	216	B161-4	149
124-18	61	235-30	57	735-25	50	BBG13.....	83
135-18	61	240-18	58	740-25	50	BBG21.....	83
140-18	62	240-25	58	744-25	50	BBG24.....	83
144-18	62	240-30	58	744-30	51	BBG35.....	83
161-4	217	244-18	59	744-36	51	BBG40.....	83
161-8	217	244-25	59	830-812A.....	220	BBG44.....	83
164-12A.....	218	244-30	59	830-89A.....	220	BMT95-4.....	233
164-12A-052.....	218	307-12	67	840-812A.....	221	BMT95-4-7	234
164-15A.....	219	310-12	67	840-89A.....	220	BMT95-8.....	234
164-8A.....	217	310-15	67	912-18	76	BMT95-8-7	234
164-8A-052.....	218	312-12	67	916-18	76	BT720-4	149
169-8	219	312-15	68	95-12	228	BT720-4-T47.....	149
170-8A.....	219	316-12	67	95-8	227	CB1	80
191-78	230	316-15	68	95-8-10	227	CB1-BP12.....	80
191-78-8.....	230	324-12	67	95-8-7	227	CB2	80
193-8	189	324-15	68	96-4	228	CB3	80
193-8-6.....	189	335-15	68	96-4X.....	228	CB4	80
194-812	231	407-15	73	96-8	229	CD4.....	84
194-89	231	410-15	73	96-8-10	229	CP700RRK.....	44
195-812	232	412-15	73	96-8-7	229	D161-8.....	148
195-89	232	414-15	74	ACS-2A.....	110	E410.....	235
198-4	232	418-15	74	AS-120-592	87	E410-11	236
198-8	233	51-4	214	AS-140-592	87	E410-11NK	236
198-8-8.....	233	51-8	214	AS100N.....	207	E410NK.....	235
221-18	55	535-25	53	ASUMRM9.....	86	ECM-RACEWY1.....	102
221-25	55	540-25	53	ATPLATE-052	211	ECM-RACEWY3.....	102
221-30	55	544-25	53	AWR2W	77	EZ195-8	237
224-18	56	544-30	53	AWR3W	77	EZ95-8	236
224-25	56	607-15	75	AWV2	87	EZ96-4	236
224-30	56	61-12W.....	215	AWV3	87	EZ96-4X	237
235-18	57	61-8W.....	215	AWV4	87	EZ96-8	237



EZB161-4.....	149	FRD40.....	50	SBK-700.....	51	SPS35-25.....	50
EZE410.....	238	FRD44.....	50	SD2-14.....	84	SPS40-25.....	50
FA-TR4.....	125	HLE/MLE-32.....	185	SD3-14.....	84	SPS44-25.....	50
FA-TR6.....	127	L20-100.....	189	SD4-14.....	84	SPS44-30.....	50
FA-TR8.....	129	L20-101.....	189	SD6-14.....	84	SPS44-36.....	50
FA170-4.....	125	L20-201.....	189	SE175-4.....	241	T51-4.....	221
FA170-6.....	127	L20-213.....	189	SE198-4.....	241	T51-8.....	222
FA170-8.....	128	L20-220.....	189	SEC1.....	80	T51-84.....	221
FA51-4.....	125	L20-222.....	189	SEC2.....	80	T61-8W.....	222
FA51-6.....	127	LL-2.....	91	SEC3.....	80	T62-8.....	222
FA51-8.....	128	LRS.....	91	SFD10.....	80	T720-4.....	223
FA720-4.....	125	M1000-USA.....	274	SFD12.....	80	T720-4BT.....	223
FA720-6.....	127	M222W.....	216	SFD14.....	80	T720-8A.....	223
FA720-8.....	128	MICCLIP.....	325	SFD16.....	80	T95-8.....	244
FA730-4.....	125	PD-30.....	178	SFD21.....	80	T95-8-10.....	244
FA730-6.....	127	PD-5VH.....	178	SFD24.....	80	T95-8-7.....	244
FA730-8.....	128	Q408.....	238	SFD35.....	80	TPP-25.....	80
FA81-4.....	125	Q418.....	238	SFD40.....	80	TPP-30.....	80
FA81-6.....	127	Q428-SA.....	239	SFD407.....	80	TPP-36.....	80
FA81-8.....	128	Q4412.....	239	SFD410.....	80	TPS-25.....	80
FA95-4.....	125	Q4612.....	239	SFD412.....	80	TPS-30.....	80
FA95-6.....	127	Q4712.....	240	SFD414.....	80	TPS-36.....	80
FA95-8.....	128	Q4812.....	240	SFD418.....	80	UHT25C-U161-8.....	205
FA97-4.....	125	QS408.....	241	SFD44.....	80	UHT25C-U51-8.....	205
FA97-4NK.....	125	RCK-18.....	82	SH1-10.....	85	UHT70C-U51-8.....	205
FA97-6.....	127	RCK-25.....	82	SH2-15.....	85	UKT25-2C-U161-8.....	205
FA97-6NK.....	127	RCK-30.....	82	SH2-22.....	85	UKT25-2C-U51-8.....	205
FA97-8.....	128	RCK-700.....	82	SH3-15.....	85	UKT70-2C-U161-8.....	205
FA97-8NK.....	128	RPM-2.....	112	SH3-22.....	85	UKT70-2C-U51-8.....	205
FAMT-6.....	188	RPM-4.....	112	SH4-15.....	85	VLS44.....	83
FAP42-TR.....	125	RR14.....	83	SH4-22.....	85	VP161A-R4.....	224
FAP62-TR.....	127	RR21.....	83	SHCK.....	85	VP161A-R8.....	224
FAP82-TR.....	128	RR24.....	83	SHRSB2.....	85	VP60R.....	224
FAPR-4.....	125	RR310.....	83	SHRSB3.....	85	VPB-1A.....	202
FAPR-6.....	127	RR312.....	83	SHRSB4.....	85	VPCS-2G-2.....	203
FAPR-8.....	129	RR316.....	83	SM191-78.....	242	VPCS-2GPB-2.....	203
FB4CPB.....	307	RR324.....	83	SM191-78-8.....	242	VPCS-3GPB-245.....	203
FMA-RRK35.....	47	RR335.....	83	SM194-812.....	243	VPVT-4PB.....	203
FMA-RRK44.....	48	RR35.....	83	SM194-89.....	242	WMA-RR10.....	83
FMA35-25G.....	48	RR40.....	83	SM195-812.....	243	WMA-RR12.....	83
FMA35-25SA.....	47	RR44.....	83	SM195-89.....	243	WMA-RR16.....	83
FMA44-25G.....	48	RX14-25.....	70	SPF2.....	80	WMA-RR24.....	83
FMA44-25SA.....	47	RX14-25SFD.....	70	SPR1.....	80	WMA-RR35.....	83
FMA44-36G.....	48	RX14-30.....	70	SPR2.....	80	WMA10-23.....	64
FMARTK25.....	47	RX14-30SFD.....	70	SPR3.....	80	WMA12-23.....	64
FMARTK36.....	48	RX21-25.....	71	SPR4.....	80	WMA16-23.....	64
FRD14.....	50	RX21-25SFD.....	71	SPR5.....	80	WMA24-23.....	65
FRD21.....	50	RX21-30.....	71	SPR6.....	80	WMA35-23.....	65
FRD24.....	50	RX21-30SFD.....	71	SPR7.....	80	WME150-592.....	87
FRD35.....	50	S162T-USA.....	131	SPR8.....	80		



Atlas Sound continues to pioneer new, improved solutions designed to help integrators make more money and close more jobs. BlueBridge DSP from Atlas changes the game and reinforces Atlas as the go to provider for all things audio.



BlueBridge DSP Can Be Deployed In A Variety of Installation Types Including Convention Center Applications

BlueBridge

Applications

Atlas Sound BlueBridge DSP controllers are powerful and flexible tools offering mission critical solutions to satisfy the exact needs of any installation. Engineered to strict standards with the highest quality internal components, BlueBridge devices provide pure clean audio, Ethernet connectivity for cost effective TCP/IP control and easy programmability. Intended for a variety of audio applications, BlueBridge DSP platforms are cost effective solutions for the most demanding applications including video conferencing, house of worship, presentation rooms, conference rooms, courtrooms, room combining, restaurants, multi-zone paging, background music, and many other sound reinforcement and AV applications.

Features

- Ultra Low Noise Floor
- Open Architecture Software for Flexibility
- Ethernet Network Connectivity
- 24Bit Converters
- 48kHz, 40 Bit Floating DSP Engine
- High Quality THAT Microphone Preamps
- Remote Control Using Optional Wall Plates
- Output Peak & Signal Indicator LEDs
- Wireless Touch Panel Options Available
- Units with Dante™ and Acoustic Echo Cancellation Available

General Description

The BlueBridge family of products feature open architecture, drag and drop software that makes them incredibly easy to use. Each model utilizes high quality THAT microphone preamps and 24 Bit converters to obtain ultra-low noise floor while still maintaining a smooth sound that satisfies the needs of demanding clients, with the flexibility and control a system designer requires. BlueBridge models use a 40 Bit Floating Point DSP engine to prevent digital clipping that commonly occurs in other DSP products and to obtain maximum speed and power to process advanced algorithms in complex system designs. BlueBridge DSP units can operate on any network while the optional control accessories require a PoE Network. When connected to a network, each BlueBridge processor on the network will be auto recognized and controllable.

BlueBridge models provide many valuable processing tools including standard mixers, gain sharing auto-mixers, delays, equalizers, level controls, duckers, filters, and dozens of other processing capabilities. Atlas Sound offers BlueBridge models that can address the needs of any size installation. Two TSD, time saving device, versions are available, the TSD-BB22 and TSD-BB44 which offer two I/O and four I/O respectively. These units are ideally suited to system designs with limited I/O's but that still require state of the art DSP. For larger applications, Atlas Sound offers models that offer 8 inputs / 8 outputs (BB-88), 8 inputs / 16 outputs (BB-816), 16 inputs / 8 outputs (BB-168), and 16 inputs / 16 outputs (BB-1616).

Atlas Sound additionally offers four models that incorporate Dante™ technology. These units are capable of being integrated into new or existing systems that are using a Dante™ network. This enables these devices to offer up to 16 channels of self-configuring, true plug-and-play digital audio over an Ethernet network providing the highest quality audio over existing network infrastructure. Additionally Atlas offers acoustic echo cancellation models that operate in both standard and Dante™ enabled systems. These models are available in 16 input / 8 output configurations and offer an excellent solution for systems that incorporate teleconferencing and video conferencing applications.



BB-88 / BB-816 / BB-168 / BB-1616

Features

- BB-88 8x8 I/O Design
- BB-816 8x16 I/O Design
- BB-168 16x8 I/O Design
- BB-1616 16x16 I/O Design
- Open Architecture Programmability
- High Quality THAT Corp Microphone Preamps
- Ethernet Network Connectivity
- Touch Panel Options Available
- TCP/IP Third Party Control Capability
- Four Logic Inputs & Outputs
- Ultra Low Noise Floor
- 48kHz, 40 Bit Floating DSP Engine
- Safety Listed to UL60005

Specifications

Input

Quantity	Eight (8) or Sixteen (16) Inputs
Type	Microphone or Line, Software Selectable
Configuration	Electronically Balanced
Gain	-40 to +15dB in 0.25dB Steps
Phantom Power	48V, Software Enabled

Output

Quantity	Eight (8) or Sixteen (16) Outputs
Type	Line
Configuration	Electronically Balanced
Gain	-40 to +15dB in 0.25 dB Steps
Output Impedance	50Ω

Digital Audio Performance

Processor	40-Bit Floating Point
Sampling Rate	48kHz

Analog Converters

High Performance 24-bit

Propagation Delay

3ms

Logic Control

Input

L1, L2, L3, L4, GND, GND,
6 Position PHX Style 3.5mm

Output

NC 1, COM 1, NO 1, NC 2, COM 2, NO 2,
6 Position PHX Style 3.5mm

DSP Modules

EQ

Parametric, Graphic, Anti Feedback

Crossover

Butterworth, Linkwitz Riley, Bessel,
Slopes: 6 to 48dB per Octave

Filters

High Shelf, Low Shelf, All Pass

Delay

10mS - 2 Seconds

Mixers

Gain Sharing Auto-Mixer, Gating Auto-Mixer,
Matrix Mixer, Standard Mixer, LR Mixer,
LCR Mixer

Generators

Sine Tone, Sign Sweep, White, Pink

Meters

RMS

Dynamics

Compressor, Expander, Limiter, Ducker

Logic

AND, OR, NOT, NAND, NOR, FlipFlop,
Multiplexor, Encoder, Decoder

General

Power

90 - 240 VAC (50 - 60Hz), Internal Power Supply

Height

1¾" (44mm)

Width

19" (483mm)

Depth

9" (229mm)

Weight

11 lbs (5kg)

Safety

UL60065



BB-1616



BB-1616 Back

BB-88DT / BB-816DT / BB-168DT / BB-1616DT

Features

- BB-88DT 8x8 I/O Design
- BB-816DT 8x16 I/O Design
- BB-168DT 16x8 I/O Design
- BB-1616DT 16x16 I/O Design
- Open Architecture Programmability
- True Plug and Play Digital Audio Networking
- Up to 16 Channels of Digital Audio Over Ethernet (Dante™)
- High Quality THAT Corp Microphone Preamps
- TCP/IP Third Party Control Capability
- Four Logic Inputs & Outputs
- 48kHz, 40 Bit Floating DSP Engine
- Safety Listed to UL60005

Specifications

Input

Quantity	Eight (8) or Sixteen (16) Inputs
Type	Microphone or Line, Software Selectable
Configuration	Electronically Balanced
Gain	-40 to +15dB in 0.25dB Steps
Phantom Power	48V, Software Enabled
Self-Configuring Dante™ Digital Ethernet	

Output

Quantity	Eight (8) or Sixteen (16) Outputs
Type	Line
Configuration	Electronically Balanced
Gain	-40 to +15dB in 0.25 dB Steps
Output Impedance	50Ω

Digital Audio Performance

Processor	40-Bit Floating Point
Sampling Rate	48kHz
Analog Converters	High Performance 24-bit
Propagation Delay	3ms

Logic Control

Input	L1, L2, L3, L4, GND, GND, 6 Position PHX Style 3.5mm
Output	NC 1, COM 1, NO 1, NC 2, COM 2, NO 2, 6 Position PHX Style 3.5mm

DSP Modules

EQ	Parametric, Graphic, Anti Feedback
Crossover	Butterworth, Linkwitz Riley, Bessel, Slopes: 6 to 48dB per Octave
Filters	High Shelf, Low Shelf, All Pass
Delay	10mS - 2 Seconds
Mixers	Gain Sharing Auto-Mixer, Gating Auto-Mixer, Matrix Mixer, Standard Mixer, LR Mixer, LCR Mixer
Generators	Sine Tone, Sign Sweep, White, Pink
Meters	RMS
Dynamics	Compressor, Expander, Limiter, Ducker
Logic	AND, OR, NOT, NAND, NOR, FlipFlop, Multiplexor, Encoder, Decoder

General

Power	90 - 240 VAC (50 - 60Hz), Internal Power Supply
Height	1¾" (44mm)
Width	19" (483mm)
Depth	9" (229mm)
Weight	11 lbs (5kg)
Safety Listed	UL60065



BB-1616DT



BB-1616DT Back



BB-168AECDT

Features

- Open Architecture Programmability
- 16x8 I/O Configurations
- Wide-Band Acoustic Echo Cancellation
- True Plug and Play Digital Audio Networking
- 16 Channels of Digital Audio Over Ethernet (Dante™)
- TCP/IP Third Party Control Capability
- Four Logic Inputs & Outputs
- 48kHz, 40 Bit Floating DSP Engine
- Safety Listed to UL60005

Specifications

Input

Quantity	Sixteen (16) Inputs with AEC
Type	Microphone or Line, Software Selectable
Configuration	Electronically Balanced
Gain	-40 to +15dB in 0.25dB Steps
Phantom Power	48V, Software Enabled
Self-Configuring Dante Digital Ethernet (Dante™)	

Output

Quantity	Eight (8) Outputs
Type	Line
Configuration	Electronically Balanced
Gain	-40 to +15dB in 0.25 dB Steps
Output Impedance	50Ω

Digital Audio Performance

Processor	40-Bit Floating Point
Sampling Rate	48kHz
Analog Converters	High Performance 24-bit
Propagation Delay	3ms

Logic Control

Input	L1, L2, L3, L4, GND, GND, 6 Position PHX Style 3.5mm
Output	NC 1, COM 1, NO 1, NC 2, COM 2, NO 2, 6 Position PHX Style 3.5mm

DSP Modules

EQ	Parametric, Graphic, Anti Feedback
Crossover	Butterworth, Linkwitz Riley, Bessel, Slopes: 6 to 48dB per Octave
Filters	High Shelf, Low Shelf, All Pass
Delay	10mS - 2 Seconds
Mixers	Gain Sharing Auto-Mixer, Gating Auto-Mixer, Matrix Mixer, Standard Mixer, LR Mixer, LCR Mixer
Generators	Sine Tone, Sign Sweep, White, Pink
Meters	RMS
Dynamics	Compressor, Expander, Limiter, Ducker
Logic	AND, OR, NOT, NAND, NOR, FlipFlop, Multiplexor, Encoder, Decoder

General

Power	90 - 240 VAC (50 - 60Hz), Internal Power Supply
Height	1¾" (44mm)
Width	19" (483mm)
Depth	9" (229mm)
Weight	11 lbs (5kg)
Safety Listed	UL60065



BB-168AECDT



BB-168AECDT Back

BB-SM1

Features

- Control BlueBridge Devices Using Any Smartphone or Tablet
- Third Party Control Interpreter Simplifies Third Party Control Programming
- Schedule and Control Processor Preset Events Using Date and Time Event Schedule Programming
- Backup Critical BlueBridge Design Files and Event Logs
- Ethernet Connectivity and Control

Specifications

Front Panel

Indicators Power and Data LEDs

Rear Panel

Connections RJ45 and RS232

General

Power 90 - 240 VAC (50 - 60Hz), Internal Power Supply

Height 1 3/4" (44mm)

Width 19" (483mm)

Depth 9" (229mm)

Weight 8 lbs (4kg)



BB-SM1 iPhone® Control



BB-SM1



BB-SM1 Back

BB-EB1616DT

Features

- 16 x 16 Dante™ Network I/O
- 16 x 16 Analog I/O
- Selectable Mic/Line Inputs
- Premium Grade THAT Corp Microphone Preamps
- 48V Phantom Power
- 48kHz Sampling
- 40 Bit, Floating Point DSP Engine
- High Performance 24 Bit Converters
- Ethernet Connectivity

Specifications

Inputs and Outputs

Input Impedance	>10k Ohms
Output Impedance	50 Ohms
Maximum Level	+20dBu
Mic Gain	0 / +40dB Steps
Type	Electronically Balanced
48V Mic Phantom Power	

Audio Performance

Frequency Response	±0.1dB (20 to 20kHz)
Dynamic Range	110dB (Unweighted)
CMRR	>100dB (50 to 10kHz)
Crosstalk	<-100dB
Distortion	0.002% (1kHz @ +4dBu)

Digital Audio Performance

Processor	40-bit Floating Point
Sampling Rate	48kHz
Analog Convertors	High Performance 24-bit

Front Panel

Signal LEDs	1 Dual Color Per Channel
Status LED	Power and Network Data

Connectors

Analog I/O	Phoenix Plug-in 3.5mm
Ethernet Network I/O	RJ45 (CAT5)
Power	Standard IEC Socket

General

Power	90 - 240 VAC (50 - 60Hz), Internal Power Supply
Height	1¾" (44mm)
Width	19" (483mm)
Depth	9" (229mm)
Weight	11 lbs (5kg)
Ventilation	Rear Exhaust Fan Side Vents (Do Not Block)
Rack Mount	1 RU Vent Between Units



BB-EB1616DT



BB-EB1616DT Back

TSD-BB22 / TSD-BB44

Features

- TSD-BB22 2 x 2 I/O Design
- TSD-BB44 4 x 4 I/O Design
- Drag and Drop Open Architecture Software
- Mic or Line Selectable Inputs
- Balanced High Gain Outputs
- Output Peak & Signal Indicator LEDs
- Ultra Low Noise Floor
- Premium THAT Corp Microphone Preamps
- BlueBridge Compatible
- Ethernet Network Connectivity
- 24Bit Converters
- 48KHz, 40 Bit Floating DSP Engine
- External Power Supply (Included)
- Remote Control Interface via Optional Wall Plates or Device Apps
- Ethernet Network Control TCP/IP
- DSP modules Drag & Drop
- EQ Parametric, Graphic Anti Feedback
- Crossover Type Butterworth, Linkwitz Riley, Bessel, Slopes: 6 to 48dB per Octave
- Filters High Shelf, Low Shelf, All Pass
- Delay 10mS - 2 Second,
- Processing Compressor, Limiter, Expander
- Mixers Gain Sharing Auto Mixer, Matrix Mixer, Gating Auto Mixer, L & R Mixer, LCR Mixer, RMS Meters, Ducker
- Generators Sine Tone, White & Pink Noise, Sine Sweep

Specifications

Input

TSD-BB22	Two (2) Inputs
TSD-BB44	Four (4) Inputs
Type	Microphone or Line Level, Selectable
Configuration	Electronically Balanced
Gain	-40 to +15dB in 0.25dB Steps
Polarity	+/- Selectable
Connection	PHX Style, 3 Position, 3.5mm Spacing
Input Impedance	>10kΩ
Maximum Input Level	+20dBu
Phantom Power	48V, GUI Enabled

Output

Gain	-40 to +15dB in 0.25 dB Steps
Connection	PHX Style, 3 Position, 3.5mm Spacing
Output Impedance	50Ω
Maximum Output Level	+20dBu

Digital Audio Performance

Processor	40-Bit Floating Point
Sampling Rate	48kHz
Analog Converters	High Performance 24-bit
Propagation Delay	3ms

General

Frequency Response	20Hz – 20kHz (±0.1dB)
Dynamic Range	110dB type (unweighted)
CMMR	> 100dB (50 to 10kHz)
Crosstalk	< -100dB
Distortion	0.002% (1kHz @+4dBu)
Preset Programs	70
Delay Units	ms, ft, m
Power	5-12VDC External Power Supply
Dimensions	1½" (38mm) x 5½" (140mm) x 2¾" (70mm)
Chassis Color	Black
Chassis Material	Aluminum
Weight	16oz, .454kg

Safety and Certifications

With External Power Supply	cUL, CE, UL
TSD	CE, CCC Listed



TSD-BB22

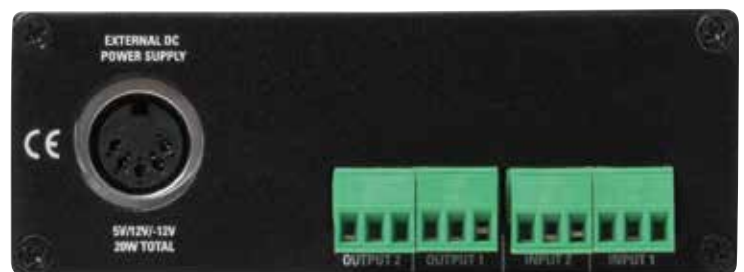

TSD-BB22 Back



TSD-BB44

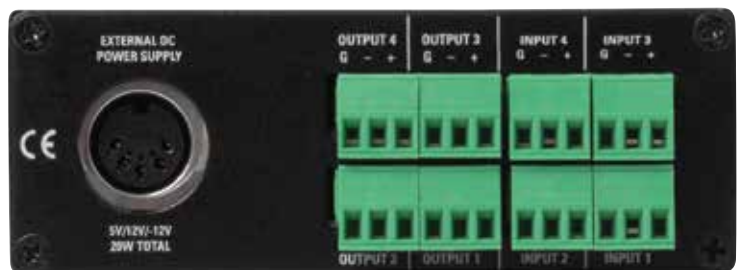

TSD-BB44 Back



Atlas Sound offers a variety of control options that integrate with the BlueBridge platform to meet the needs of diverse installations of all sizes.

BlueBridge Accessories

Applications

BlueBridge TouchPanel and wall controls are a natural extension of the BlueBridge DSP platform and provide a simple and cost effective way to ensure the end user is able to understand and operate a sophisticated system.

Features

- Contemporary Design
- Network Controlled
- Work with All BlueBridge DSP Controllers

General Description

The Atlas Sound BBWP-TOUCH7 is a custom PoE 7" Touch Screen that can be customized to control any function using the BlueBridge software. An integrator can easily turn this touch panel into a multi source or zone volume control, allow for muting capabilities of installed hardware, or create a mixer that can adjust the system on the fly. BlueBridge software allows the integrator to tailor the touchscreen to the exact needs of the users and facility. The touch screen can also be customized to match the installation with color changing options as well as the ability to integrate logos into the screen. The touch screen can be password protected to ensure authorized use only.

Additionally, Atlas Sound offers wall plates in five configurations that can be configured to fit the unique needs of a particular application. The BBWP-K1B allows control of any single value change preset by the integrator including gain, threshold, and frequency adjustment. The BBWP-S4K1 is a four-button controller with level control that can be used to change any four preset selections and control any single value change. The BBWP-K4B is a four-button controller with level control that can be used to change any four preset selections and control any four-value changes. The BBWP-S8B is an eight-button controller that can be used to change preset selections. Finally, the BBWP-S4B is a four-button controller that can be used to change any four preset selections.



BlueBridge TouchPanels and Wall Controls Are Convenient and User Friendly In Any Application



BBWP-TOUCH7B

Features

- 7" Touchscreen LCD Display
- On / Off Select Button
- Aluminum Front Panel
- RJ45 Ethernet Connector
- External Power: Wall Supply Jack
- Recommended Power Method: Power Over Ethernet (PoE)
- Also Available in White

Specifications

Power	Wall Supply Included, When Not Using PoE
Wall Mounting	Back Box Included
Dimensions	10" x 5.1" x 1.2" (245mm x 130mm x 30mm)
Weight	2 lbs (0.9kg)



BBWP-K1B

Features

- Power and Network Status Indicator LEDs
- 1 Label Slot with Plastic Cover
- 1 Level Control with LED Ladder Level Indicator
- Aluminum Front Panel
- RJ45 Ethernet Connector
- External Power: 2 Pin Detachable Euro Connector
- IP Reset Switch Push Button
- Recommended Power Method: Power Over Ethernet (PoE)
- Also Available in White

Specifications

Power	5 Volts DC @ 1A, Power Supply Included 48VDC - PoE
Wall Mounting	Fits a 2-Gang Back Box
Dimensions	4½" x 4½" (Front Panel)
Weight	2 lbs (0.9kg)

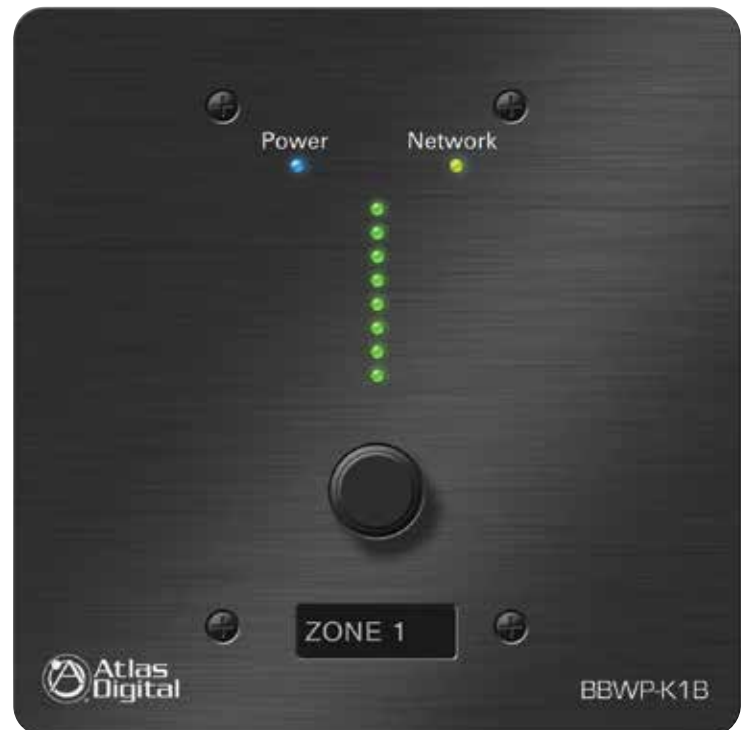

BBWP-S4K1B

Features

- Power and Network Status Indicator LEDs
- 4 Label Slots with Plastic Covers
- 1 Level Control with LED Ladder Level Indicator
- Aluminum Front Panel
- RJ45 Ethernet Connector
- External Power: 2 Pin Detachable Euro Connector
- IP Reset Switch Push Button
- Recommended Power Method: Power Over Ethernet (PoE)
- Also Available in White

Specifications

Power	5 Volts DC @ 1A, Power Supply Included 48VDC - PoE
Wall Mounting	Fits a 2-Gang Back Box
Dimensions	4½" x 4½" (Front Panel)
Weight	2 lbs (0.9kg)



BBWP-S8B

Features

- Power and Network Status Indicator LEDs
- 8 Label Slots with Plastic Covers
- Aluminum Front Panel
- RJ45 Ethernet Connector
- External Power: 2 Pin Detachable Euro Connector
- IP Reset Switch Push Button
- Recommended Power Method: Power Over Ethernet (PoE)
- Also Available in White

Specifications

Power	5 Volts DC @ 1A, Power Supply Included 48VDC - PoE
Wall Mounting	Fits a 2-Gang Back Box
Dimensions	4½" x 4½" (Front Panel)
Weight	2 lbs (0.9kg)



BBWP-K4B

Features

- Power and Network Status Indicator LEDs
- 5 Label Slots with Plastic Covers
- 1 Level Control with LED Ladder Level Indicator
- Aluminum Front Panel
- RJ45 Ethernet Connector
- External Power: 2 Pin Detachable Euro Connector
- IP Reset Switch Push Button
- Recommended Power Method: Power Over Ethernet (PoE)
- Also Available in White

Specifications

Power	5 Volts DC @ 1A, Power Supply Included 48VDC - PoE
Wall Mounting	Fits a 2-Gang Back Box
Dimensions	4½" x 4½" (Front Panel)
Weight	2 lbs (0.9kg)



BBWP-S4B

Features

- Power and Network Status Indicator LEDs
- 4 Label Slots with Plastic Covers
- Aluminum Front Panel
- RJ45 Ethernet Connector
- External Power: 2 Pin Detachable Euro Connector
- IP Reset Switch Push Button
- Recommended Power Method: Power Over Ethernet (PoE)
- Also Available in White

Specifications

Power	5 Volts DC @ 1A, Power Supply Included 48VDC - PoE
Wall Mounting	Fits a 2-Gang Back Box
Dimensions	4½" x 4½" (Front Panel)
Weight	2 lbs (0.9kg)





Atlas Sound mixer amplifiers are available in several configurations to meet the needs of most installation scenarios

Mixer Amplifiers

Applications

Atlas Sound mixer amplifiers incorporate excellent power output with multiple input interfaces allowing for the connection of a variety of devices based on installation requirements. Atlas mixer amplifiers are ideal solutions for retail, hospitality, hotel, medical centers, and other applications where BGM and paging uses are required.

Features

- Multi-Input Capability
- RCA and Phoenix Style Connectors
- Front Panel Input Gain Controls
- Rack Mount Capability
- Safety Listed

General Description

The Atlas Sound AA35, 35 watt output, and AA60, 60 watt output, are 3 input mixer amplifiers designed for distributed business paging and background music (BGM) systems, small to medium speech privacy systems and in applications where music on hold (MOH) plus paging is required. With one microphone input and two stereo line inputs these units will accommodate a variety of input sources including paging microphones, CD players, and digital music receivers. A dip switch selectable matrix allows sources for music or messaging on hold applications. 25V, 70.7V, and 8 Ω outputs are provided. Output power matches nicely with Atlas Sound FAP, SM, SD, and GD series loudspeakers.

The AA120 and AA240 mixer amplifiers are 120 Watts and 240 Watts respectively that are ideal for use in large retail, commercial, and industrial paging and background music applications. These powerful, unique features assist the contractor or installer in today's commercial business audio environment. These amplifiers feature six input units feature extensive muting and output options along with a very unique bridge in/out feature to allow combining of multiple amplifiers in ballroom applications without the need for external relays. VCA control is included which may be assigned to the BGM input or globally for the entire amplifier.

The AA120M is the most versatile mixer amplifier in the industry today. Features include true three zone matrixing; 120 watt main output, additional 1 Watt output, and line level output, 24VDC output with relay sync to the mute bus, bridge I/O with built-in relay control, one industry standard module input with direct to mix bus or direct to amp assignment, global or BGM input VCA control, and multiple mute bus configuration options. The AA120M is perfectly suited for use in sound masking, industrial paging, retail and BGM, commercial PA, hotel/resort, and priority volume control applications. The AA120M has an expansion port for optional modules to improve the functionality of the AA120M. These modules include versions for chime generating, mic/line input with remote control, and a sound masking generator.



Atlas Mixer Amps Can Be Deployed In A Variety Of Applications Including Ballrooms

The Atlas Sound MA40G and MA60G mixer amplifiers utilize a small footprint and are engineered for reliability. These amplifiers are ideally suited for deployment in distributed business paging and background music (BGM) systems, small to medium speech privacy systems and in applications and installations where mixer functionality is required.

Each unit has three total inputs including a balanced mic/line input featuring phantom power and variable mute sensitivity control as well as two unbalanced, summing line level inputs. Additional features include removable level controls with "set it and forget it" security cover, contact closure mute terminals, and a global (100VAC-240VAC) power supply.

TSD distribution amplifiers can be used in a variety of installation scenarios. One scenario in which the TSD-DA13, 1 x 3 distribution amp, can be effectively deployed involves adding three balanced line level "press feeds" that each receive an isolated signal to a sound system for recording and engineering purposes but the existing house system only has one unbalanced output available. That unbalanced line level output can be connected to the input on the TSD-DA13. The positive and negative terminals on the three outputs can then be connected to the wall plate or other termination where the recording devices are connected solving the problem.

The TSD-DA28 is a 2 x 8 distribution amp that can be applied in multiple situations. Once commonly encountered situation involves an installation where the owner wants to use a single audio source that has a single unbalanced, stereo output to deliver content to four separate zones, each of which has a dedicated amplifier. An example of this would be a resort/hotel that wanted to provide BGM to the lobby, pool area, tennis courts, and restaurant. Input 1 can be used as the "left" channel and Input 2 can be used as the "right" channel of the stereo source. Outputs 1-4 would be "left" and Outputs 5-8 would be "right" allowing a simultaneous signal to be sent to each zone where volume level could be controlled via that zone's amplifier.

AA35

Features

- 1 Mic In W/ Phantom Power
- 2 Stereo Line Inputs
- Dual Line Outputs
- Pre Out / Power in Patch
- Remote and Vox Activated Mute
- Route Any Source Combination or Entire Mix Bus to Zone 2 (MOH Out)
- Special Low Cut Filter is 6DBU / Octave at 400Hz and Also Bypasses Front Panel Bass Control to Allow Use With Paging Horns Like APX40TN and AP-15T
- 35 Watts of True Output Power
- Optional Rack Mount Kit - AARMK2-5



AA35

Specifications

Power Rating	Max. Average Power @ 50Hz – 20kHz with .5% THD (10- 80kHz filter) 8Ω, 1kHz, 0.5% THD 35 Watts RMS
Inputs	Line / Tel 316mV (-10dBV) 10kΩ (optional 600Ω transformer available) Mic .316mV~3.16mV (-50dBV~ -30dB V) Line 316mV (10dBV) 10kΩ
Outputs	Transformer coupled, balanced, 8Ω, 25V, and 70.7V Zone 2- 8Ω Unbalanced 1 Watt Zone 2- 600Ω Balanced 1.5V
Frequency Response	50Hz - 20Hz
Power Consumption	150 Watts
Rack Spaces	2 High ½ Width
Connector Type	Phoenix and RCA
Height	3.69" (94mm) with Feet
Width	8.25" (210mm)
Depth	10.875" (276mm)
Weight	10.2 lbs (4.64kg)
Safety Listed	UL60065



AA35 Back

AA60

Features

- 1 Mic in W/ Phantom Power
- 2 Stereo Line Inputs
- Dual Line Outputs
- Pre Out/ Power in Patch
- Remote and VOX Activated Mute
- Route Any Source Combination or Entire Mix Bus to Zone 2 (MOH Out)
- Special Low Cut Filter is 6dB / Octave at 400Hz and Also Bypasses Front Panel Bass Control to Allow Use With Paging Horns Like APX40TN and AP-15T
- 60 Watts of True Output Power
- Optional Rack Mount Kit - AARMK2-5



AA60

Specifications

Power Rating	60 Watts RMS @ 70.7V (Maximum Average Power @ 50Hz to 20kHz with .5% THD)
Inputs	Input #1 Mic/Line/Tel (Optional Transformer Available) Inputs #2-3 Unbalanced RCA Summing Line Level
Outputs	Main: 60 Watts RMS 8Ω, 25V, and 70.7V Zone 2: 8Ω at 1.5 Watts & 600Ω line level at 1.5V
Frequency Response	50Hz - 20Hz
Power Consumption	90 Watts
Rack Spaces	2RU High, ½ Rack Width
Connector Type	Phoenix and RCA
Height	3.66" (93mm) with Feet
Width	8.27" (210mm)
Depth	10.87" (276mm)
Weight	10.2lbs (4.64kg)
Safety Listed	UL60065



AA60 Back

AA120

Features

- 6 Channel Mixer Amplifiers
- 5 Mic / Line Inputs With Phantom Power and 1 Stereo Summing Aux Input
- Remote or VOX Mute Capabilities
- Zone 2 MOH Out From CH6 Line Source
- Special Low Cut Filter is 6dB / Octave at 400Hz and Also Bypasses Front Panel Bass Control to Allow Use With Paging Horns Like APX40TN
- Bridge In / Out Circuit With Balanced Link / Internal Relay to Engage Circuit is Perfect for Small Room Combining Systems
- Pre Out / Power Amp in for Patching External Processors
- Optional Rack Mount Kit – AARMK2-0

Specifications

Power Rating	120 Watts RMS @25V/70.7V/100V/8Ω
Inputs	Line / Tel 316mV (-10dBV) 10kΩ (Optional 600Ω Transformer Available) Mic .316mV~3.16mV (-50dBV~ -30dBV) Line 316mV (10dBV) 10kΩ
Outputs	Main: Transformer Coupled, Balanced, 8Ω, 25V, 70V, and 100V, Zone 2- 8Ω Unbalanced 1 Watt, 2.83V, Zone 2- 600Ω Balanced 1.5V
Frequency Response	50Hz-20Hz
Power Consumption	300 Watts
Rack Spaces	2RU
Connector Type	PHX, RCA, and Barrier Strip
Height	4.219" (107mm)
Width	16.54" (420mm)
Depth	14.06" (357mm)
Weight	26.44 lbs (12kg)
Safety Listed	UL60065



AA120 Front

AA240

Features

- 6 Channel Mixer Amplifier
- 5 Mic / Line Inputs With Phantom Power and 1 Stereo Summing Aux Input
- Remote or VOX Mute Capabilities
- Zone 2 MOH Out From CH6 Line Source
- Special Low Cut Filter is 6dB / Octave at 400Hz and Also Bypasses Front Panel Bass Control to Allow Use With Paging Horns Like APX40TN
- Bridge In / Out Circuit With Balanced Link / Internal Relay to Engage Circuit is Perfect for Small Room Combining Systems
- Pre Out / Power Amp in for Patching External Processors
- Optional Rack Mount Kit – AARMK2-0

Specifications

Power Rating	240 Watts RMS @25V/70.7V/100V/8Ω
Inputs	Line / Tel 316mV (-10dBV) 10kΩ (optional 600Ω transformer available) Mic .316mV~3.16mV (-50dBV~ -30dBV) Line 316mV (10dBV) 10kΩ
Outputs	Main: Transformer Coupled, Balanced, 8Ω, 25V, 70V, and 100V, Zone 2- 8Ω Unbalanced 1 Watt, 2.83V, Zone 2- 600Ω Balanced 1.5V
Frequency Response	50Hz - 20Hz
Power Consumption	500 Watts
Rack Spaces	2RU
Connector Type	PHX, RCA, and Barrier Strip
Height	4.219" (107mm)
Width	16.54" (420mm)
Depth	14.06" (357mm)
Weight	27.85 lbs (12.63kg)
Safety Listed	UL60065



AA240 Back

AA120M

Features

- 1 Module Input
- 1 Stereo Line (BGM) Input
- 24VDC Output and Patchable Relay Assignable to CC or VOX Mute Circuit (Allows Use of Atlas Priority Attenuators Without Any Additional Hardware)
- 4 Mic / Line Inputs
- Bridge I/O With Relay Like AA120/AA240
- Channel 2-4 and 6 Can be Configured for Mute Receive or Channels 2-4 Mute Send
- Input Trim Control Per Channel
- Module Input Features Mix Bus or "Amp Direct" Routing (Perfect for Sound Masking as Masking Source is Not Affected by Front Panel EQ Settings and Treble Control Can be Used for Adding HF to Page in Masking Systems)
- Separate Zone 2/3 Matrix Per Channel
- VCA Control Assignable to CH5 BGM Input or Main Mix Bus
- VOX Mute and Contact Closure Mute May be Assigned Separately for "Quasi" Dual Level Mute Priority Via Internal Jumpers
- Zone 2 / 3 Output (Line Level and 1 Watt 8Ω)

Specifications

Power Rating	120 Watts RMS @25V/70.7V/100V4Ω
Inputs	Line / Tel 316mV (-10dBV) 10kΩ, Mic.316mV~(70dBV- 50dBV), Line 100mV (-10dBV) 10Ω, Mic .316mV~3.16mV (-70dBV~-50dBV), Line 316mV/100mV (-10dBV/-20dBV) Selectable, Module Input
Outputs	Main: Transformer Coupled, Balanced, 4Ω, 25V, 70.7V, and 100V, Zone 2- 8Ω Unbalanced 1 Watt Zone 2- 600Ω Balanced 1.5V
Frequency Response	50Hz - 20Hz
Power Consumption	300 Watts
Rack Spaces	2RU
Connector Type	PHX, RCA, and Barrier Strip
Height	4.24" (108mm) with Feet
Width	16.54" (420mm)
Depth	13.84" (352mm)
Weight	26.75 lbs (12.16kg)
Safety Listed	UL60065



AA120M



AA120M Back

AA-TG

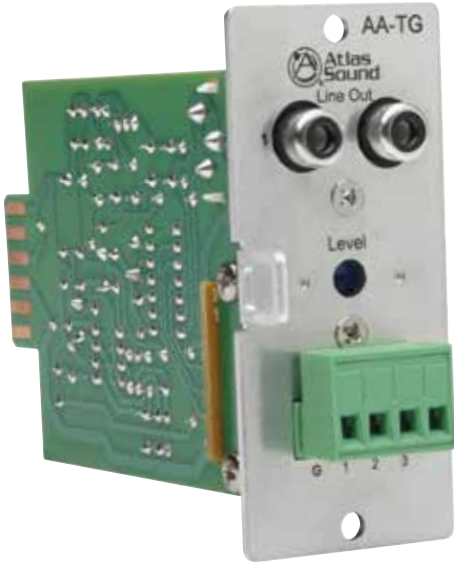

Features

- Tone Generator Input Module
- 3 Selectable Tones
- Front Panel Level Adjust

Specifications

Connector Type	Phoenix Connector
Output	300mV

AA-ML



Features

- Mic/Line Input Module
- Balanced Mic Input
- Front Panel Level Control
- Mic / Line Input Selectable
- Summing Unbalanced Input

Specifications

Connector Type	Phoenix Connector
Sensitivity	300mV

AA-SMG



Features

- Sound Masking Module
- EQ Insert
- Front Panel Level and EQ Trim Controls
- Variable Low Cut 1kHz – 7kHz, Defeatable on Line Out
- Line Level Output Pre or Post EQ
- White/Pink Noise Generator

Specifications

Connector Type	RCA and TRS 1/4"
----------------	------------------

MA40G

Features

- One Balanced Mic/Line/Tel Input w/ Phantom Power
- 2 Unbalanced, Summing Line Level Inputs
- Variable VOX Mute Sensitivity Control for Input 1
- Contact Closure Mute Terminals
- Global Power Supply, 100VAC-240VAC ~ 50/60Hz
- Compact 1RU, ½ Rack Width
- Optional Rack Mount Kit - PA702-RMK

Specifications

Power Rating	40 Watts @ 70.7V (125Ω), 40 Watts @ 100V (250Ω)
Inputs	One Balanced, Two Unbalanced
Frequency Response	50Hz - 20Hz
Power Consumption	Idle 8 Watts, 0.075A, 27 BTU Average 24 Watts, 0.26A, 81 BTU Max 71 Watts, 0.8A, 242 BTU
Rack Spaces	1RU
Connector Type	Phoenix and RCA
Height	1.75" (45mm)
Width	8.5" (216mm)
Depth	7.81" (198mm)
Weight	2.9 lbs (1.32kg)
Safety Listed	UL60065



MA60G

Features

- One Balanced Mic/Line/Tel Input w/ Phantom Power
- 2 Unbalanced, Summing Line Level Inputs
- Variable VOX Mute Sensitivity Control for Input 1
- Contact Closure Mute Terminals
- Global Power Supply, 100VAC-240VAC ~ 50/60Hz
- Compact 1RU, ½ Rack Width
- Optional Rack Mount Kit - PA702-RMK

Specifications

Power Rating	60 Watts @ 70.7V (83Ω), 60 Watts @ 100V (166Ω)
Inputs	One Balanced, Two Unbalanced
Frequency Response	50Hz - 20Hz
Power Consumption	Idle 8 Watts, 0.075A, 27 BTU Average 34 Watts, 0.41A, 116 BTU Max 102 Watts, 1.25A, 348 BTU
Rack Spaces	1RU
Connector Type	Phoenix and RCA
Height	1.75" (44mm)
Width	8.5" (216mm)
Depth	7.81" (198mm)
Weight	2.9 lbs (1.32kg)
Safety Listed	UL60065

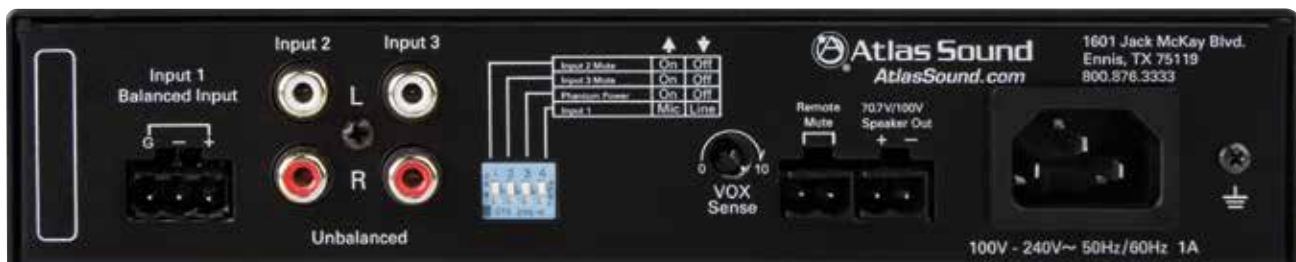

TSD-DA13

Features

- 1 x 3 Distribution Amplifier
- One (1) Balanced Mic/Line Input with Switchable 24V Phantom Power
- High Gain (50dB), Low Noise Mic Preamp
- Summed Dual RCA Input
- Three (3) Isolated Balanced Mic/Line Outputs
- 12dB/Octave Low Cut Filter @ 125Hz
- Signal/Peak Indicator LEDs
- High Gain Output for Driving Long Balanced Lines
- Removable Phoenix Style I/O Connectors
- Separate Ground Connections
- Energy Efficient
- Power Supply Sold Separately



TSD-DA13

Specifications

Input Impedance	1.2K Ω Balanced, 600 Ω Unbalanced
Output Impedance	300 Ω Balanced, 150 Ω Unbalanced
Frequency Response	20Hz - 20kHz (+/-1dB)
THD	.06% & 1kHz
Signal to Noise Ratio	90dB
24VDC Power Requirements	60mA
Height	1½" (38.1 mm)
Width	4" (101.6 mm)
Depth	2½" (63.5 mm)
Weight	6 oz. (.170 kg)

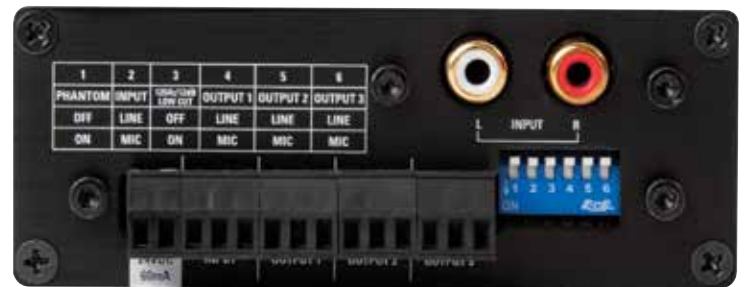

TSD-DA13 Back

TSD-DA28

Features

- 2 x 8 Distribution Amplifier
- Two (2) Balanced Line Inputs
- Eight (8) Isolated Balanced Line Outputs
- Signal & Peak Indicator LEDs For Each Channel
- High Gain Output for Driving Long Balanced Lines
- Separate Ground Connections
- Removable Phoenix Style I/O Connectors
- Security Covers Included for All Front Panel Controls
- Energy Efficient
- Power Supply Sold Separately



TSD-DA28

Specifications

Input Impedance	10K Ω Balanced, 5K Ω Unbalanced
Output Impedance	300 Ω Balanced, 150 Ω Unbalanced
Frequency Response	20Hz - 20kHz (+/-1dB)
THD	.06% & 1kHz
Signal to Noise Ratio	90dB
24VDC Power Requirements	80mA
Height	1½" (38.1mm)
Width	4" (101.6mm)
Depth	2½" (63.5mm)
Weight	6 oz. (.170 kg)

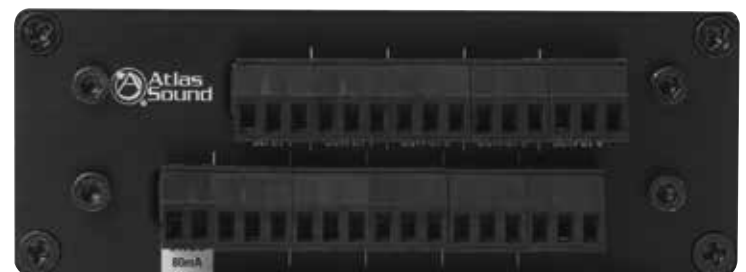

TSD-DA28 Back



Atlas Sound power amplifiers are designed to meet the power requirements of almost any installation scenario and deliver sound where and when it is needed.

Power Amplifiers

Applications

Atlas Sound power amplifiers are available in several different power levels offering a solution for any type of installation. These amplifiers can be used in a variety of applications, from large distributed, constant voltage systems to high SPL sound reinforcement systems, Atlas Sound power amplifiers deliver an excellent combination of power and value.

Features

- Balanced Inputs
- RCA and Phoenix Style Connectors
- Front Panel Input Gain Controls
- Rack Mount Capability
- Safety Listed

General Description

The Atlas Sound CP400 and CP700, 400Watts and 700Watts 2-channel power amplifiers, are specifically designed for demanding contractor applications. These units feature an esoteric grade toroidal power supply and output transformers that feature outstanding reliability as well as extended frequency response. The CP400/CP700 can be confidently selected because they utilize true transformer output isolation. Independent channels are driven by separate power supplies to ensure maximum channel separation and ultra low distortion figures while providing years of faithful service.

The Atlas Sound PA40G and PA60G, 40 watt and 60 watt power amplifiers, utilize a small footprint and are engineered for reliability. The low cost and excellent performance make them the ideal choice in background music, paging, and small to medium speech privacy system applications. Each unit has a balanced line level input via phoenix connector and a summing unbalanced RCA input. Output is to 70.7/100V speaker lines via phoenix connector and additional features include status LEDs, removable level controls with "set it and forget it" security covers, and a global (100VAC-240VAC) power supply.

The PA1001G single channel amplifier features a patent pending mounting system via a sealed hole incorporated into the chassis design. The PA1001G delivers 100 watts from a single channel at 70.7V. The unit features balanced Phoenix style and unbalanced RCA connections, which can be mixed using a level control. Other features include an accessory outlet with AC current sensing, separate audio sensing turn-on, mixer trim control, front panel status LEDs, and recessed, adjustable tone and level controls. The current sensing and audio turn-on allow the PA1001G to respond from standby mode when the projector is turned on remotely or when an audio signal is received.

The PA601 is the perfect choice for distributed Background Music (BGM) systems when the requirement is simple amplification without Music On Hold (MOH) or advanced mix functionality. The PA601 delivers 60W at 70.7V in a compact package with simple rear mounted RCA and Phoenix



CP700



PA60G

inputs and RCA outputs plus a unique loudness contour control which provides just the right amount of bass enhancement for low level listening environments.

The DPA102PM is the first network controlled amplifier offered by Atlas Sound. This unique amplifier delivers 100 watts across 2 channels a 8Ω. The DPA102PM includes a patent pending through hole pole mounting design making it easy to mount with video projectors with the added benefit of increased security. This unit features Ethernet network connectivity and control, AC current sense turn-on, audio sense turn-on, balanced Phoenix style and unbalanced RCA input connections, front panel status LEDs, and recessed tone/level controls. The onboard firmware features an innovative, easy to use web-based GUI designed for all computers, tablets or phones which allows for local or remote control of EQ settings, level control and troubleshooting. Multi-tiered security can be implemented for proper access control and to avoid tampering.

TSD power amplifiers are also useful in multiple installation scenarios as both the specified product or as a solution to an owner requested addition or change to the design. TSD power amplifiers are available in mono 70.7V, TSD-PA10VG and TSD-PA20VG, and 2-channel 4Ω/8Ω, TSD-PA122G and TSD-PA252G, versions capable of delivering up to 50W of RMS power. These amplifiers can be used to add sound reinforcement in a conference room working in conjunction with a projector or other audio source. One installation scenario where a TSD power amplifier can be effectively incorporated involves a house of worship whose congregation has outgrown the size of its building and attendees now have to stand in the foyer or courtyard where there are no speakers. The TSD-PA10VG is an ideal solution in this scenario. Source audio can be run to this area and connected to the TSD-PA10VG through the balanced line level input. Eight speakers tapped at 1W can then be connected to the amplifier to provide the local sound reinforcement. The speaker level can then be adjusted through the front panel control. Atlas Sound TSD amplifiers are the cost effective, convenient solution for complex installation problems.



CP400

Features

- 25V, 70.7V, 100V, and Direct Coupled (2,4, & 8Ω) Outputs Mounted on Barrier Strips With Covers for Safety
- Balanced Inputs on Barrier Strip and XLR Connectors
- Dual-Speed, High Efficiency Fan Cooling
- Loop Through Feature on Male XLRs, One Per Channel Input
- Power-Up Muting
- Short-Circuit, Temperature, and DC Offset Protection
- Soft Clip Limiter Protection
- Stepped Attenuators Mounted on the Rear for Security
- Stereo, Bridge, or Parallel Operating Modes Selectable Via Rear Mounted Switch
- Toroidal Output Transformers Provide Full Electrical Isolation and Meet Worldwide Safety Agency Approval

Specifications

Frequency Response	30Hz - 16kHz (±3dB)
Channels	Two
Connector Type	Terminal Block & XLR
Finish	Black
Number of Fans	1 - Variable Speed
Output Power	175 Watts/Channel @ 25V 200 Watts/Channel @ 70.7V, 400 Watts 140V/200V Bridge Mono 240 Watts/Channel @ 4Ω
Rack Spaces	3RU
Height	5.1875" (132mm)
Width	18.9" (480mm)
Depth	16.875" (429mm)



CP700

Features

- 25V, 70.7V, 100V, and Direct Coupled (2,4, & 8Ω) Outputs Mounted on Barrier Strips With Covers for Safety
- Balanced Inputs on Barrier Strip and XLR Connectors
- Dual-Speed, High Efficiency Fan Cooling
- Loop Through Feature on Male XLRs, One Per Channel Input
- Power-Up Muting
- Short-Circuit, Temperature, and DC Offset Protection
- Soft Clip Limiter Protection
- Stepped Attenuators Mounted on the Rear for Security
- Stereo, Bridge, or Parallel Operating Modes Selectable Via Rear Mounted Switch
- Toroidal Output Transformers Provide Full Electrical Isolation and Meet Worldwide Safety Agency Approval

Specifications

Frequency Response	30Hz - 50kHz
Channels	Two
Connector Type	Terminal Block & XLR
Finish	Black
Number of Fans	1 - Variable Speed
Output Power	280 Watts/Channel @ 25V 350 Watts/Channel @ 70.7V, 700 Watts 140V/200V Bridge Mono 400 Watts/Channel @ 4Ω
Rack Spaces	3RU
Height	5.187" (132mm)
Width	18.9" (480mm)
Depth	16.875" (429mm)



PA60G

Features

- One Balanced Mic/Line/Tel Input w/ Phantom Power
- 2 Unbalanced, Summing Line Level Inputs
- Variable VOX Mute Sensitivity Control for Input 1
- Contact Closure Mute Terminals
- Compact 1RU, ½ Rack Width
- One Balanced Line Input
- One Unbalanced, Summing Line Level Input
- Global Power Supply, 100VAC-240VAC ~ 50/60Hz
- Optional Rack Mount Kit - PA702-RMK

Specifications

Frequency Response	50Hz - 20kHz
Connector Type	Phoenix and RCA
Output Power	60 Watts
Height	1.75" (45mm)
Width	8.5" (216mm)
Depth	7.81" (198mm)
Net Weight	2.9 lbs. (1.32kg)
Safety Listed	UL60065



PA60G



PA60G Back

PA40G

Features

- One Balanced Mic/Line/Tel Input W/ Phantom Power
- 2 Unbalanced, Summing Line Level Inputs
- Variable VOX Mute Sensitivity Control for Input 1
- Contact Closure Mute Terminals
- Compact 1RU, ½ Rack Width
- One Balanced Line Input
- One Unbalanced, Summing Line Level Input
- Global Power Supply, 100VAC-240VAC ~ 50/60Hz
- Optional Rack Mount Kit - PA702-RMK

Specifications

Frequency Response	50Hz - 20kHz
Connector Type	Phoenix and RCA
Output Power	40 Watts
Height	1.75" (45mm)
Width	8.5" (216mm)
Depth	7.81" (198mm)
Net Weight	2.9 lbs. (1.32kg)
Safety Listed	UL60065



PA40G



PA40G Back

PA1001G

Features

- 100W x 1 @ 70.7V/100V
- Ultra Efficient Amplification Technology
- Patent Pending, Through Chassis Mounting System for Use With Pole Mounted Projector Systems
- Multi Voltage Power Supply Allows for Worldwide Operation
- Optional Rack Mount Kit - PA702-RMK



Specifications

Output Power	100 Watts @ 70V into 50Ω 100 Watts @ 100V into 100Ω
Frequency Response	30Hz-20kHz No High Pass Filter +/-3dB 100Hz-20kHz High Pass Engaged +/-3dB
Power Consumption	10 Watts in Sleep Mode 16 Watts in Active Idle Mode 165 Watts at Full Load 70V
Optional Rack Mount Kit	PA702-RMK
Height	1.75" (44mm)
Width	8.5" (216mm)
Depth	13.5" (343mm)
Weight	4.9 lbs. (2.4 kg)
Safety Listed	UL60065

PA601

Features

- 1 Balanced Or Unbalanced Input
- 1 Unbalanced Line Output
- 60 Watt Single Input Power Amp
- Dual Voltage Operation 110 - 220 VAC
- Loudness Contour Switch (+4dBu @ 100Hz and 10kHz)
- Simple Clean Power
- Optional Rack Mount Kit - AARMK2-5

Specifications

Output Power	60 Watts
Frequency Response	50Hz-20kHz ±3dB
Connector Type	Phoenix and RCA
Rack Spaces	2RU High 1/2 Wide
Height	3.068" (780mm) with Feet
Width	8.25" (210mm)
Depth	14" (356mm)
Safety Listed	UL60065



PA601



PA601 Back

TSD-PA10VG

Features

- 4Ω/25V/70.7V/100V Output
- One (1) Balanced Input
- Removable Level Control with Set-It-And-Forget-It Security Cover
- Input Signal and Peak Indicator LEDs
- Cable Management System
- Removable Phoenix Style I/O Connectors
- Energy Efficient
- Compact Chassis Design
- Power Supply Sold Separately
- Optional Rack Mount Kit - TSD-RMK

Specifications

Power Output	10W @ 4Ω 5W @ 8Ω, 10W @ 25V/70V/100V Loads
Line Input Level	500mV (-6dBV) Balanced
Frequency Response	40Hz - 20kHz (+/-3dB)
THD	.5% @ 1kHz
Signal to Noise Ratio	78dBV
24VDC Power Requirements	240mA
Height	1½" (38.1mm)
Width	4" (101.6mm)
Depth	2½" (63.5mm)



TSD-PA10VG

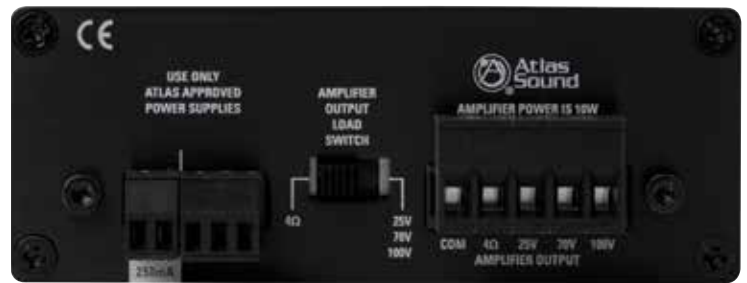

TSD-PA10VG Back

TSD-PA20VG

Features

- 4Ω/25V/70.7V/100V Output
- One (1) Balanced Input
- Removable Level Control with Set-It-And-Forget-It Security Cover
- Input Signal and Peak Indicator LEDs
- Cable Management System
- Removable Phoenix Style I/O Connectors
- Energy Efficient
- Compact Chassis Design
- Power Supply Sold Separately
- Optional Rack Mount Kit - TSD-RMK

Specifications

Power Output	20W @ 4Ω 10W @ 8Ω, 20W @ 25V/70V/100V Loads
Line Input Level	500mV (-6dBV) Balanced
Frequency Response	40Hz - 20kHz (+/-3dB)
THD	15% @ 1kHz
Signal to Noise Ratio	78dBV
24VDC Power Requirements	490mA
Height	1½" (38.1mm)
Width	4" (101.6mm)
Depth	5½" (132mm)



TSD-PA20VG



TSD-PA20VG Back

TSD-PA122G

Features

- 12W @ 4Ω x 2 Channels
- Bridgeable to 24W at 8Ω Mono Output
- Balanced Stereo Inputs
- Unbalanced Stereo Inputs Via Dual RCA Connectors
- Input Signal & Peak Indicator LEDs
- Removable Phoenix Style I/O Connectors
- Security Covers Included for All Front Panel Controls
- Energy Efficient
- Power Supply Sold Separately
- Optional Rack Mount Kit - TSD-RMK

Specifications

Power Output	12W @ 4Ω x 2 CH 6W @ 8Ω x 2 CH, 24W @ 8Ω Bridged
Unbalanced Input Impedance	10KΩ
Input Level	316mV (-10dBV)
Balanced Input Impedance	10KΩ Balanced, 5KΩ Unbalanced
Line Input Level	500mV (-6dBV) Balanced
Frequency Response	20Hz - 20kHz (+/-3dB)
THD	1% & 1kHz
Signal to Noise Ratio	80dBV
24VDC Power Requirements	1000mA
Height	1½" (38.1mm)
Width	4" (101.6mm)
Depth	2½" (63.5mm)



TSD-PA122G



TSD-PA122G Back

TSD-PA252G

Features

- 25W @ 4Ω x 2 Channels
- Bridgeable to 50W at 8Ω Mono Output
- Balanced Stereo Inputs
- Unbalanced Stereo Inputs Via Dual RCA Connectors
- Input Signal & Peak Indicator LED's
- Removable Phoenix Style I/O Connectors
- Security Covers Included for All Front Panel Controls
- Energy Efficient
- Power Supply Sold Separately
- Optional Rack Mount Kit - TSD-RMK

Specifications

Power Output	25W x 2 CH @ 4Ω 50W x 1 CH @ 8Ω Bridged
Unbalanced Input Impedance	10kΩ
Input Level	316mV (-10dBV)
Balanced Input Impedance	10KΩ Balanced, 5KΩ Unbalanced
Line Input Level	500mV (-6dBV) Balanced
Frequency Response	20Hz - 20kHz (+/-3dB)
THD	.2% & 1kHz
Signal to Noise Ratio	80dBV
24VDC Power Requirements	2000mA
Height	1½" (38.1mm)
Width	4" (10.16mm)
Depth	5½" (13.2mm)



TSD-PA252G



TSD-PA252G Back

DPA102PM

Features

- Ready to Use, No Configuration Required
- DSP Signal Processing
- 2 x 100 Watt Class-D Technology
- Controllable with Smart Phone Browser
- Ethernet Network Connectivity
- Auto-Discovery Software
- Remote Monitoring of Status & Levels
- 1RU High, 1/2 Rack Wide
- Convection Cooled
- Through Chassis Pole Mounted Projector System
- Energy Efficient
- Optional Rack Mount Kit - PA702-RMK

Specifications

Power Output	50 Watts per Channel @ 8Ω 100 Watts per Channel @ 4Ω
Unbalanced Input Impedance	10kΩ
Frequency Response	-3dB 20Hz-20kHz
THD	0.2% at rated output
Signal to Noise Ratio	100dB
Height	1.75" (45mm)
Width	8.5" (215mm)
Depth	13.5" (343mm)
Weight	4.9lbs (2.4Kg)



DPA102PM



DPA102PM Back

DPA Software

The Atlas Sound DPA Series amplifiers feature a combination of flexibility, performance and control to provide high value features for applications that require more than just great sound. Atlas DPA amplifiers can be used right out of the box as traditional power amplifiers requiring no programming, special set-up, or network connectivity.

However, if you need more from the amplifier, the web enabled DPA Series has an assortment of DSP tools including level controls, EQ's, limiters, high & low pass filters, delays and summing to provide great flexibility for a range of applications. Once configured, the amplifier can be password protected to prevent unauthorized changes. The embedded control software allows the integrator to lock out the front panel controls as well as maintain proper settings.

To make the DPA-102PM a "game changer" we've combined the advantages of on board DSP with an integral web server to give you the ability to remotely control DSP functions and levels as well as monitor output levels and the status of any DPA amplifier on the network. To make it easier to identify and set-up DPA amplifiers on the network, Atlas Sound provides DPA Discovery a tool available for PC's and Apple mobile devices.



Amplifier Configuration



DPA Software Set-Up Interface



Output Level Adjustment Through Software



Amplifier EQ Control Interface Software

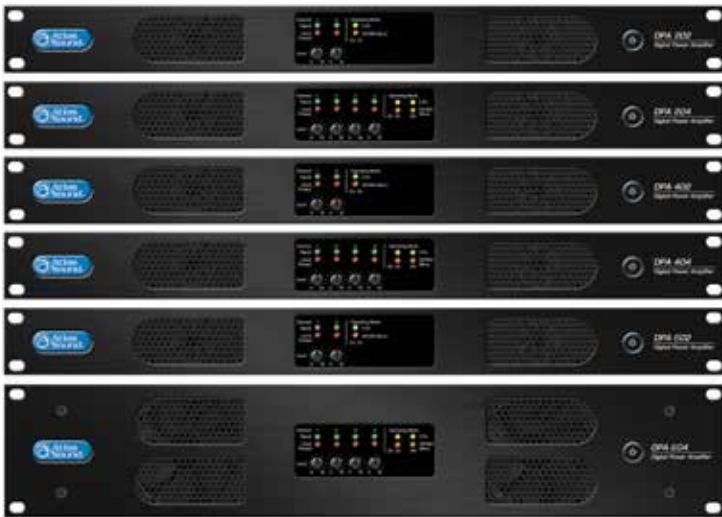

Future Models Available

Model	Description	4Ω Power Output	70.7V/100V Power Output
DPA202	2-Channel Networkable Power Amplifier	2 x 200 Watts	1 x 400 Watts
DPA402	2-Channel Networkable Power Amplifier	2 x 400 Watts	1 x 700 Watts
DPA602	2-Channel Networkable Power Amplifier	2 x 600 Watts	1 x 1000 Watts
DPA204	4-Channel Networkable Power Amplifier	4 x 200 Watts	2 x 400 Watts
DPA404	4-Channel Networkable Power Amplifier	4 x 400 Watts	2 x 700 Watts
DPA604	4-Channel Networkable Power Amplifier	4 x 600 Watts	2 x 1000 Watts



The innovative F6 amplifier can be configured to suit the individual amplification and sound system requirements of a variety of applications. This functionality makes the F6 the most flexible, energy efficient amplifier on the market today.



The F6-MF Can Power All The Speakers In A Facility, Including Multiple Floors And Outdoor Areas



F6-MF

Modular Amplifiers

Applications

The Atlas Sound F6 Amplifier Mainframe System is the industry's most versatile multi-channel amplifier. An innovative, modular input and 6-bay output section allows the F6 to be easily configured for most 4Ω/8Ω or 70.7V zone amplification applications.

Features

- Supports Up to 6 Amplifier Channels
- Accommodates both 70.7V and 8Ω Amplifier Modules
- Rack Mount Capability
- Front Panel Status LEDs
- Expansion Slot for Optional Input Modules
- Safety Listed

General Description

The Atlas Sound the F6-MF chassis can be fitted with up to six uniquely engineered amplifier modules. The straight path design of the F6-MF is the essence of simplicity; yielding clean, accurate, and dynamic sound. The FM250-4 (4Ω/8Ω) and FM250-70 (70.7V) power modules can be loaded into any of the six F6-MF amplifier card slots and are designed to deliver up to 250 Watts per channel.

The Ultra Fast recovery switch mode power supply is routed to each output module through quad-ganged connector contacts, to minimize the impedance path allowing for maximum current delivery. Each amplifier module includes its own power supply, high-current, low ESR (Equivalent Series Resistance) capacitors which provide immediate local, on demand current. This allows each channel to produce clean, instantaneous, high impact audio power. The direct coupled power supply is designed to route any and all available energy to the channels that require it. This innovative feature known as Power Rail Direct Coupling™, or PRDC, technology enables channels that demand more energy to benefit from the pooled resources so it can deliver more power, more efficiently.

The F6-MF Chassis can be purchased with up to six FM250-4 modules, up to six FM250-70 modules, in any combination. Additional modules can also be ordered as needed to satisfy future system or purchasing requirements. The input design of the F6-MF is based on an open architecture concept, permitting application and installation flexibility. Six balanced inputs via Phoenix termination feed a variety of optional accessory interface cards. The F6-MF offers an Energy Save "Standby" Mode. The amplifier can be turned on remotely via a contact closure (CC) or a DC Voltage of 5V–24V. A LED located on both the Front & Rear panels of the F6-MF indicates the operation mode of the amplifier.

The FM250 power modules are loaded with useful features including front and rear channel status indicators, selectable gain, signal limiters, 100Hz Hi-Pass filter, and tamper proof level controls. The FM250 Series Power Modules are designed to be 90% efficient, allowing the amplifier to run cooler and consume less energy than conventional commercial amplifiers.

The F6-AMIX is an 8 input by 6 output analog mixer card designed for use with the F6-MF. The F6-AMIX module adds increased functionality and value to the F6-MF Multi-Impedance Modular Amplifier, reducing the need for additional external devices for more complex paging and background music systems. The F6-AMIX Multi-Function Analog Input Mixer Card is feature loaded with stereo summed and Mic/Line inputs with global assignment, signal mixing and remote level control, and mute priority capabilities.



F6-MF

Features

- Modular Input and Output Section
- 70.7V or 4Ω/8Ω, 250 Watts Amplifier Modules Available
- 110-240VAC Power Supply Allows for Global Operation
- Intuitive Metering on Front and Back Panels
- Optional Analog Mixer Input Card Available, F6-AMIX
- Security Cover Included for Front Panel Input Attenuation
- Fan Assisted Cooling With Rear Intake and Front Exhaust
- Light Weight Power Rail Direct Coupling (PRDC) Technology
- Ultra-Efficient Class D Amplification Topology
- Energy Save Mode, Remote Activation
- Safety Listing

Specifications

Power Consumption Standby	5 Watts
6 Channels Loaded (Average)	550 Watts, 4.5A, 1876 BTU
6 Channels Loaded (Idle)	16 Watts, 130mA, 54 BTU
6 Channels Loaded (Max)	1650 Watts, 14A, 5630 BTU
Protection Circuits	AC Fuse 12A 250V, Thermal, Short Circuit, Limiter, Inrush
Height	3.5" (89mm)
Width	19" (482mm)
Depth	13.5" (343mm)
Weight	21 lbs. (9.5kg) Unloaded
Safety Listed	UL60065



F6-MF with Amplifier Cards Loaded

FM250-70

Features

- 70.7V Operation
- Fixed 30Hz High Pass Filter
- Selectable Input Sensitivity Per Channel, 1V Or 2V
- 30dB Per Channel Voltage Gain
- Balanced 20K Input Impedance
- Safety Listed

Specifications

Power Output	250 Watts
Frequency Response	30Hz - 20kHz
Signal to Noise Ratio	-90dB Below Rated Output
Height	3.4" (86mm)
Width	1.5" (38mm)
Depth	10.4" (264mm)
Weight	0.8 lbs. (.36kg)
Safety Listing	UL60065



FM250-4

Features

- 4Ω/8Ω Operation
- Fixed 30Hz High Pass Filter
- Selectable Input Sensitivity Per Channel, 1V Or 2V
- 30dB Per Channel Voltage Gain
- Balanced 20K Input Impedance
- Safety Listed

Specifications

Power Output	250 Watts
Frequency Response	30Hz - 20kHz
Signal to Noise Ratio	-90dB Below Rated Output
Height	3.4" (86mm)
Width	1.5" (38mm)
Depth	10.4" (264mm)
Weight	0.8 lbs. (0.36kg)
Safety Listing	UL60065

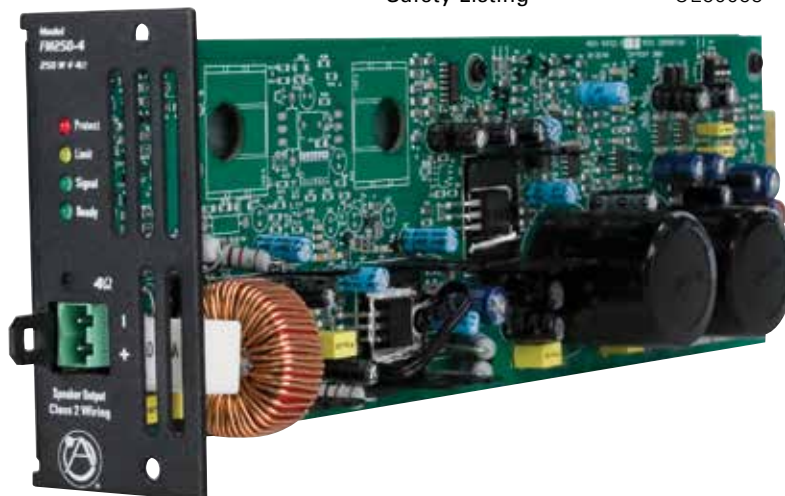

F6-AMIX

Features

- Mic/Line Input with Phantom Power
- AUX Input with Stereo Summing
- Matrix Routing of Mic/Line and AUX Inputs to Any Output
- Separate Remote Level Control of Mic and AUX Inputs
- Mute Bus with VOX and Contact Closure Muting



Specifications

Connection	RCA Left and Right Actively Summed
Impedance	10K Ω
Input Level	316mV (-10dBv) Balanced Mic or Line Selectable
Inputs	1 Unbalanced
Connection	Removable 3 Position Captive Screw 3.5mm Spacing
Impedance	1.2K Balanced, 600 Ω Unbalanced
Line Input Level	1V Balanced
Mic Input Level	40dB Gain Balanced From F6-MF Input
Connection	Removable 3 Position Captive Screw 3.5mm Spacing
Line Input Level	1V Balanced Controls
Input Level Control	Channels 1-6, Mic/Line, RCA Summed
Remote Level Control	Port Mic/Line and RCA, Qty 2 Removable 2 Position Captive Screw 3.5mm Spacing for Each Port
VOX Sensitivity	2mV-20mV
Phantom Power	15VDC
Frequency Response	20Hz-20kHz +/-1dB
THD	0.06% at 1Khz Average
Height	1.55" (40mm)
Width	6.125" (156mm)
Depth	5.34" (135mm)
Weight	5.6 Oz, .16G



Each channel of the F6-MF can power different wings or floors in applications like hospitals or office buildings.



Atlas Sound is proud to expand its amplifier offering with the DNA Series amplifiers from Innovative Electronic Designs. This enables our integrators to have an Atlas amplifier solution for their CobraNet® and Dante™ installation projects.

IED Amplifiers

Applications

The DNA series of amplifiers from Innovative Electronic Designs allow system designers to expand existing systems or furnish new installations using CobraNet® or Dante™ to add a few audio zones where necessary. The amplifiers feature either CobraNet® or Dante™ digital audio input and four channels of 200 watt amplification.

Features

- Compatible with IED GLOBALCOM Systems and 3rd Party Dante™ or CobraNet® Devices
- Dual-Redundant Ethernet Ports
- Output Audio Monitoring
- 70.7 Volt or 100 Volt Output Models Available
- LED Indicators for Power, Audio Signals and Faults
- Supports Independent Background Music For All Channels with Automatic Ducking When Paging Audio Is Present
- Two Inputs For Ambient Noise Sensors Per Amplifier Output Channel
- Certified to Safety Listing UL60065

General Description

The DNA series amplifiers feature either CobraNet® or Audinate's Dante™ digital audio input and four channels of 200 watt amplification. The DNA78x4 amplifiers are controlled with network commands for selecting input routing and configuring EQ, delay, output levels, and ambient noise level compensation. The internal amplifier cards are class-D, dual channel 200W amplifiers. DNA models are defined by higher efficiency, increased reliability, improved performance, and lower operating cost that competing models. IED's design is stable under all load conditions (phase angles of 0 to 360 degrees) and the amplifier card has 34dB of gain from its analog input to the loudspeaker output. Attenuation is handled ahead of the power amplifier by DSP controls through software.

Inputs are provided for connecting up to eight (8) 540S ambient noise sensors (2 sensors for each output channel). This allows the output of each channel to be automatically adjusted in realtime based on the measured ambient noise level in the zone. The power amplifier has built-in voltage limiting to protect the loudspeakers being driven and a temperature sensor on the heatsink that automatically shuts down an amplifier that becomes too hot. The DNA78x4 series amplifiers feature LED indicators for power, audio signals and fault status. A Form C relay is also included that will indicate if a fault is present.

The DNA7874 amplifiers provide 200 watts per channel for 70.7-volt transformer-distributed loudspeaker systems and the DNA7814 amplifiers provide 200 watts per channel for 100-volt transformer-distributed loudspeaker systems. Models DNA7874L and DNA7814H utilize CobraNet®

for digital audio. Models DNA7874DL and DNA7814DH utilize Audinate's Dante™ for digital audio transmissions. Models DNA7874L and DNA7874DL operate from a 120 VAC power source and models DNA7814H and DNA7814DH operate from a 240 VAC power source.

IED additionally offers two single channel and two dual channel amplifiers for use in smaller applications that require full-bandwidth audio and where low power and low cost are considerations. The IED1581 amplifiers have a single channel output that offers 8 watts of power at either 4Ω or 8Ω. Model IED1581C incorporates CobraNet® digital audio inputs while the IED1581D features Dante™ digital audio inputs. The IED1542 amplifiers feature 2-channel output at either 4Ω or 8Ω with total output power of 4 watts per channel. Model IED1542C incorporates CobraNet® digital audio inputs while the IED1542D features Dante™ digital audio inputs. All models are powered by either an external 48VDC power supply or IEEE 802.3af PoE switch and have remote monitoring output available.

Atlas Sound also offers the IED backup amplifier switch, model IED1544BAS, that offers four independent channels of backup amplifier switching for 4Ω, 8Ω, 70.7V, or 100V speaker lines up to 500-watts per channel. This unit can be used with any amplifier system that provides dry contact closures for fault conditions. The unit is network capable and can be configured via a standard web browser via IP address or using the IED GLOBALCOM System Management Console. This small unique switch can be DIN rail or wall mounted for use both inside and outside of a rack and it is powered by an external 48VDC power supply or IEEE 802.3af PoE switch. Connections are made via Phoenix connector and unit includes indicator LEDs for power and channel status.



IED DNA amplifiers offer scalable implementation for a variety of installations.



DNA7874L

Features

- Four 200-Watt Amplifier Output Channels @ 70.7V
- Supports CobraNet® Digital Audio Inputs
- Compatible with IED GLOBALCOM Systems and 3rd Party CobraNet® Devices
- Dual-Redundant Ethernet Ports
- 7-Band Parametric EQ and A High-Pass And Low-Pass Filter Per Channel
- Signal Delay Up To 25ms On Each Channel
- Output Audio Monitoring
- LED Indicators For Power, Audio Signals And Faults
- Built-In Supervision Of Amplifier Cards And Loudspeaker Lines
- Fault Reports And Amplifier Status Available Over Ethernet Using Standard SNMP Protocol
- Supports Independent Background Music For All Channels With Automatic Ducking When Paging Audio Is Present
- Two Inputs For Ambient Noise Sensors For Each Amplifier Output Channel

Specifications

Power Rating	200 Watts RMS @ 70.7V
Inputs	Ethernet (Control and Digital Audio), Fault Relay 4-Pin Phoenix, Qty 8 Ambient Sensor 3-Pin Phoenix
Outputs	4-Pin Phoenix, 2 Channels Per Block
Frequency Response	20Hz – 20kHz
Power Requirements	120VAC
Connector Types	Ethernet (RJ45) and Phoenix
Width	19" (483mm)
Height	3.5" (89mm)
Depth	17" (43mm)
Weight	19.2 lbs (8.7kg)
Safety Listing	UL1711 & UL60065



DNA7874L



DNA7874L Back

DNA7874H

Features

- Four 200-Watt Amplifier Output Channels @ 100V
- Supports CobraNet® Digital Audio Inputs
- Compatible with IED GLOBALCOM Systems and 3rd Party CobraNet® Devices
- Dual-Redundant Ethernet Ports
- 7-Band Parametric EQ And A High-Pass And Low-Pass Filter Per Channel
- Signal Delay Up To 25ms On Each Channel
- Output Audio Monitoring
- LED Indicators For Power, Audio Signals And Faults
- Built-In Supervision Of Amplifier Cards And Loudspeaker Lines
- Fault Reports And Amplifier Status Available Over Ethernet Using Standard SNMP Protocol
- Supports Independent Background Music For All Channels With Automatic Ducking When Paging Audio Is Present
- Two Inputs For Ambient Noise Sensors For Each Amplifier Output Channel

Specifications

Power Rating	200 Watts RMS @ 100V
Inputs	Ethernet (Control and Digital Audio), Fault Relay 4-Pin Phoenix, Qty 8 Ambient Sensor 3-Pin Phoenix
Outputs	4-Pin Phoenix, 2 Channels Per Block
Frequency Response	20Hz – 20kHz
Power Requirements	240VAC
Connector Types	Ethernet (RJ45) and Phoenix
Width	19" (483mm)
Height	3.5" (89mm)
Depth	17" (432mm)
Weight	19.2 lbs (8.7kg)
Safety Listing	UL1711 & UL60065



DNA7874H



DNA7874H Back

DNA7874DL

Features

- Four 200-Watt Amplifier Output Channels @ 70.7V
- Supports Dante™ Digital Audio Inputs
- Compatible with IED GLOBALCOM systems and 3rd party Dante™ devices
- Dual-Redundant Ethernet Ports
- 7-Band Parametric EQ And A High-Pass And Low-Pass Filter Per Channel
- Signal Delay Up To 25ms On Each Channel
- Output Audio Monitoring
- LED Indicators For Power, Audio Signals And Faults
- Built-In Supervision Of Amplifier Cards And Loudspeaker Lines
- Fault Reports And Amplifier Status Available Over Ethernet Using Standard SNMP Protocol
- Supports Independent Background Music For All Channels With Automatic Ducking When Paging Audio Is Present
- Two Inputs For Ambient Noise Sensors For Each Amplifier Output Channel

Specifications

Power Rating	200 Watts RMS @ 70.7V
Inputs	Ethernet (Control and Digital Audio), Fault Relay 4-Pin Phoenix, Qty 8 Ambient Sensor 3-Pin Phoenix
Outputs	4-Pin Phoenix, 2 Channels Per Block
Frequency Response	20Hz – 20kHz
Power Requirements	120VAC
Connector Types	Ethernet (RJ45) and Phoenix
Width	19" (483mm)
Height	3.5" (89mm)
Depth	17" (432mm)
Weight	19.2 lbs (8.7kg)
Safety Listing	UL1711 & UL60065



DNA7874DL



DNA7874DL Back

DNA7814DH

Features

- Four 200-Watt Amplifier Output Channels @ 100V
- Supports Dante™ Digital Audio Inputs
- Compatible with IED GLOBALCOM Systems and 3rd party Dante™ Devices
- Dual-Redundant Ethernet Ports
- 7-Band Parametric EQ And A High-Pass And Low-Pass Filter Per Channel
- Signal Delay Up To 25ms On Each Channel
- Output Audio Monitoring
- LED Indicators For Power, Audio Signals And Faults
- Built-In Supervision of Amplifier Cards And Loudspeaker Lines
- Fault Reports And Amplifier Status Available Over Ethernet Using Standard SNMP Protocol
- Supports Independent Background Music For All Channels With Automatic Ducking Where Paging Audio Is Present
- Two Inputs For Ambient Noise Sensors For Each Amplifier Output Channel
- Certified to Safety Listing UL60065

Specifications

Power Rating	200 Watts RMS @ 100V
Inputs	Ethernet (Control and Digital Audio), Fault Relay 4-Pin Phoenix, Qty 8 Ambient Sensor 3-Pin Phoenix
Outputs	4-Pin Phoenix, 2 Channels Per Block
Frequency Response	20Hz – 20kHz
Power Requirements	240VAC
Connector Types	Ethernet (RJ45) and Phoenix
Width	19" (483mm)
Height	3.5" (89mm)
Depth	17" (432mm)
Weight	19.2 lbs (8.7kg)
Safety Listing	UL1711 & UL60065



DNA7874H



DNA7874H Back

IED1542NA-D

Features

- Dual Channel Output
- 4-Watts Per Channel at 4Ω or 8Ω
- Dante™ Digital Audio Inputs
- DIN Rail or Wall Mount

Specifications

Height	3.5" (89mm)
Width	6.99" (178mm)
Depth	2.08" (52.8mm)
Weight	4 lbs (1.82kg)



IED1581NA-D

Features

- Single Channel Output
- 8-Watts at 4Ω or 8Ω
- Dante™ Digital Audio Inputs
- DIN Rail or Wall Mount

Specifications

Height	3.5" (89mm)
Width	6.99" (178mm)
Depth	2.08" (52.8mm)
Weight	4 lbs (1.82kg)



IED1581NA-C

Features

- Single Channel Output
- 8-Watts at 4Ω or 8Ω
- CobraNet® Digital Audio Inputs
- DIN Rail or Wall Mount

Specifications

Height	3.5" (89mm)
Width	6.99" (178mm)
Depth	2.08" (52.8mm)
Weight	4 lbs (1.82kg)



IED1542NA-C

Features

- Dual Channel Output
- 4-Watts Per Channel at 4Ω or 8Ω
- CobraNet® Digital Audio Inputs
- DIN Rail or Wall Mount

Specifications

Height	3.5" (89mm)
Width	6.99" (178mm)
Depth	2.08" (52.8mm)
Weight	4 lbs (1.82kg)



IED1544BAS

Features

- Four Independent Back Up Channels
- Compatible With 4Ω, 8Ω, 70.7V, or 100V Speaker Lines
- Supports Up To 500-Watts Per Channel
- Phoenix Type Connectors
- Indicator LEDs on Front Panel
- DIN Rail or Wall Mount

Specifications

Height	3.5" (89mm)
Width	6.99" (178mm)
Depth	2.08" (52.8mm)
Weight	4 lbs (1.82kg)



Atlas offers a wide variety of amplifiers that can be applied in almost any facility.

AA-PPRC

Features

- Priority Paging Remote Control
- 12VDC UL Power Supply (Included)
- 2 Channel
- 350 Watts @ 70.7V Per Channel
- Audio High Level Trigger Sense With Threshold Adjust 3V - 45V
- Audio Line Level Trigger Sense With Threshold Adjust 20mv - 2V
- Contact Closure Trigger
- DC Trigger 5V - 24V
- Finish Black With White Lettering
- Phoenix Type I/O Connectors
- Relay Recover Adjustment 1 - 30 Seconds
- Relay Trigger Threshold Adjust
- Speaker Line Remote Switcher

Specifications

Shipping Weight	2.00 lbs (0.91 kgs)
Frequency Response	20 Hz - 20 kHz Flat
Connector Type	Four Position Detachable Phoenix Connector
Finish	Black
Load Capacity	5 AMPS
Compatible With	8Ω, 25V, 70.7V, 100V Systems
Height	1.5" (3.81mm)
Width	4" (10.16mm)
Depth	4.5" (11.43mm)



CP700RRK

Features

- 3RU Rear Rack Mounting Option for CP700/CP400
- Attractive Black Finish to Match Amplifier
- Convenient Kit Includes All Necessary Hardware

Specifications

Height	5.25" (133mm)
Width	19" (483mm)
Depth	19" (483mm)
Shipping Weight	5.00 lbs (2.27 kgs)



AAIT-600

Features

- 600Ω Input Impedance
- Easily Installed on Main Circuit Board
- Provides Ground Loop Isolation

Specifications

Height	1.25" (31.8mm)
Width	.625" (15.9mm)
Depth	.75" (19.1mm)
Shipping Weight	0.50 lbs (0.23 kgs)



WPD-VC10K

Features

- White Decor Style Plate, ABS Material
- Fits a Single Gang Electrical Outlet
- 2 or 3 Conductor Interface Connection
- Removable 3 Position Phoenix Style Connector, 5.08 mm Pin Spacing
- Removable Label Guard Allows for Clean Identification



Specifications

Height	4.5" (114mm)
Width	2.5" (64mm)
Depth	2.4" (60.9mm)

AARMK2-5

Features

- 2RU Rack Mounting Option for AA35, AA60, and PA601
- Attractive Black Finish to Match Amplifier
- Convenient Kit Includes Hardware

Specifications

Height	3.5" (89mm)
Width	1.25" (31.8mm)
Shipping Weight	1 lb (0.45 kgs)



AAVC-10K

Features

- 10KΩ Linear Taper Insures Smooth Level Control
- Attractive Decora Style Wall Plate in Ivory and White Finishes
- Convenient Kit Includes Hardware
- Simple 2 Conductor Wiring



Specifications

Height	4.75" (120.7mm)
Width	2.5" (64mm)
Shipping Weight	0.50 lbs (0.23 kgs)

AARMK2-0

Features

- 2RU Rack Mounting Option for AA120, AA120M, and AA240 Amplifier
- Attractive Black Finish to Match Amplifier
- Convenient Kit Includes Hardware

Specifications

Height	3.5" (8.89 cm)
Width	1.25" (3.175 cm)
Shipping Weight	1.00 lb (.45 kgs)



AAVCC-5

Features

- Covers Panel Opening and Volume Dial
- Kit Includes 5 Security Covers
- Near Flush Mount Appearance
- Snap Securely In Front Panel Hole

Specifications

Depth	0.375" (08.7mm)
Diameter	1.06" (26.2mm)
Shipping Weight	0.50 lbs (0.23 kgs)



PA702-RMK

Features

- 1RU Rack Mounting Option for Half Rack Width Amplifiers
- Attractive Black Finish to Match Amplifier
- Convenient Kit Includes Hardware

Specifications

Height	1.75" (44.5mm)
Shipping Weight	0.77 lbs (0.35 kgs)

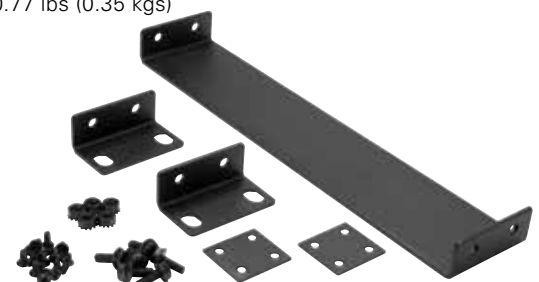



FMA Series racks were developed to offer all of the features that could be required in an installation. Heavy-duty construction, added width, include rear door and several available accessories allow the FMA Series to meet the demands of any job today and into the future. The FMA Series offers both stand alone and gangable models.

19" Wide Opening Stand-Alone / Gangable Deep Floor Cabinet with Adjustable Rails, Swing Out Side Panels UL Listed

Applications

The Atlas FMA Series cabinets, designed for a high strength-to-weight ratio solution, are ideal for single and multi-bay applications with increased width for wire management. These cabinets are commonly used to house Data Center Equipment, Communications equipment, Audio Video equipment, Computer equipment, Broadcast equipment, Security systems, CCTV equipment, IT equipment, Industrial systems and Building Management Systems. These cabinets are built to Standard #EIA-310-C that meets most OEM, Commercial and Military application requirements.

Features

- UL Listed 1678
- Two Model Heights with Increased Width for Wire Management
- Rear Door Offers Right- or Left-Hand Hinging Capability
- Up to (12RU to 18RU) Panel Opening in Top Offers Wiring Convenience or Fan Panel Cooling with Optional EFT / EFP Series Fan Kits and TPP / TPS Top Panels
- Two Pairs of 12-gauge CRS Adjustable Mounting Rails, Plated, Drilled and Tapped 10-32 with Hash Marks to Indicate Rack Unit Increments
- Hat Rack Rail Supports Include Rail Slot and Retainer Hole to Secure Rails from Sliding While Moving, Slots for Cable Pass Through and 19" Spacing for Mounting Standard Panels for Accessory Mounting
- Increased Opening Base Facilitates Wiring to Conduit or to Access Below Floor Raceways
- 3RU Galvanized Filler Panel (5¼") Provided
- Manufactured to E.I.A. Standards
- Includes Perforated Front, Rear and Side Vents for Heat Dissipation
- Knockouts on Removable Standard 2RU Panels (Rear of Cabinet Top & Bottom) Panel Includes ¾" KOs for BNC Connectors as Well as Conduit Array of Knockouts. Leg Levelers Included
- Threaded Hinge Inserts are Pre-Drilled on Both the Left and Right Sides of the Rack Allowing for Easy Installation with No Extra Drilling Required
- 14-gauge Tops / Bottoms / Frames
- 16-gauge Side Panels and Side Frames
- 2RU Panel On Bottom for Cable Pass-Through Between Cabinets
- Optional Lift-Off, Locking Side Panels--"Swing-Out" Design Facilitates Easy Service Access (G Series Only)
- Gangable Cabinet with Pre-Installed ¼-20 Thread Inserts to Gang Cabinets (G Series Only)



FMA44-25SA

Shown with Optional Front Door, SFD44



Precision Automated Laser Cutting Machine Ensures Consistent Part Reproduction



General Description

The Atlas Sound FMA (Folded Metal Assembly) cabinet incorporates an innovative "Radius" look characterized by sleek corners and joints. The cabinets are 25½" deep or 36" deep, 24⅞" wide and available in two different RU heights. All cabinets feature both 14 / 16-gauge steel tops / bottoms and frames. A flush mount 16-gauge steel rear door with integral "stop" to prevent over-travel is included as standard. Rear door includes flush door pull and cylinder lock.

The FMA Series cabinet line includes an opening in the cabinet top which can left open for free wire access / ventilation, partially covered with the ISOPANEL™ for non-conductive cable access or closed using standard panels 12RU (for 25½" deep models) or 18RU (for 36" deep models). Top opening is also perfect for installing EFP Series fan or TPP / TPS Top panel assembly. Cabinets include two pairs of front-to-rear adjustable mounting rails tapped 10-32. Rails are standard E.I.A. 5/8"-5/8"-1/2" spacing.

The Atlas Sound FMA G Series features 14-gauge "hat" rack rail support sections for added strength & greater versatility in rack rail positioning. The hat sections include a rack rail slot along with holes spaced the entire length of the hat section to allow for easy, secure positioning of the rack rails. This hat section is also spaced in the cabinet to allow the

installation of standard 19" blank panels vertically inside the cabinet. This is perfect for Time Saving Devices (TSD) or other accessories like Atlas Sound DC power supplies & relays. Hat sections feature tie down holes for clean, organized wire management.

For optimum wire management, unique, removable 2RU high panels are positioned behind cutouts at the top & bottom on the rear of the cabinet. These panels include conduit array knockouts with four ½" to ¾" concentric, three 1" to 1¼" "concentric and two ¾"" knockouts to allow installation of BNC connectors used for diversity wireless microphone systems. Leg levelers are included with the FMA to provide alignment regardless of floor evenness. An optional caster kit allows easy positioning without significantly increasing the cabinet's overall height. Threaded inserts are pre-installed on the front of the cabinet when a front door is required. Threaded inserts are also supplied to gang cabinets together.

Optional FMA G Series side panels "swing-out" for easy serviceability of equipment housed in the cabinet while maintaining security. These heavily reinforced side panels install easily on unique "lift-off" hinge assemblies. All mounting holes and cabinet hardware is provided to join multiple FMA G Series cabinets.

FMA35-25SA



Specifications

Width (Outside)	24.12" (612.65mm)
Height (Outside)	69.31" (1760.54mm)
Depth (Outside)	25.5" (648mm)
Panel Space	35RU, 61.31" (1557.34mm)
Usable Depth	24.125" (612.775mm)
Top Panel Opening	12RU, 21.06" (535mm)
Floor Mounting Hole Location	23.28" (591.55mm)
UL Listed	1678

Optional Accessories

1" Deep Plexiglass Front Door	PFD35
1" Deep Solid Front Door	MPFD35
1" Deep Perforated Front Door	SFD35
3" Deep Perforated Front Door	MPFD35-3
Solid Top Panel	TPS-25
Perforated Top Panel	TPP-25
Fan Panel Top	EFT-25
Vented Side Panel	FMA35-25LRPV
Roller Cart / Caster Kit	FMARTK25
Additional Rack Rails	FMA-RRK35

FMA44-25SA



Specifications

Width (Outside)	24.12" (612.65mm)
Height (Outside)	85.06" (2160.59mm)
Depth (Outside)	25.5" (648mm)
Panel Space	44RU, 77.06" (1957.39mm)
Usable Depth	24.25" (615.95mm)
Top Panel Opening	12RU, 21.06" (535mm)
Floor Mounting Hole Location	23.28" (591.55mm)
UL Listed	1678

Optional Accessories

1" Deep Plexiglass Front Door	PFD44
1" Deep Solid Front Door	MPFD44
1" Deep Perforated Front Door	SFD44
3" Deep Perforated Front Door	N/A
Solid Top Panel	TPS-25
Perforated Top Panel	TPP-25
Fan Panel Top	EFT-25
Vented Side Panel	FMA44-25LRPV
Roller Cart / Caster Kit	FMARTK25
Additional Rack Rails	FMA-RRK44

FMA35-25G



Specifications

Width (Outside)	24.12" (612.65mm)
Height (Outside)	69.31" (1760.54mm)
Depth (Outside)	25.5" (648mm)
Panel Space	35RU, 61.31" (1557.34mm)
Usable Depth	23.53" (598mm)
Top Panel Opening	12RU, 21.06" (535mm)
Floor Mounting Hole Location	23.28" (591.55mm)
UL Listed	1678

Optional Accessories

1" Deep Plexiglass Front Door	PFD35
1" Deep Solid Front Door	MPFD35
1" Deep Perforated Front Door	SFD35
3" Deep Perforated Front Door	MPFD35-3
Solid Top Panel	TPS-25
Perforated Top Panel	TPP-25
Fan Panel Top	EFT-25
Vented Side Panel	FMA35-25LRPV
Roller Cart / Caster Kit	FMARTK25
Additional Rack Rails	FMA-RRK35

FMA44-25G



Specifications

Width (Outside)	24.12" (612.65mm)
Height (Outside)	85.06" (2160.59mm)
Depth (Outside)	25.5" (648mm)
Panel Space	44RU, 77.06" (1957.39mm)
Usable Depth	23.53" (598mm)
Top Panel Opening	12RU, 21.06" (535mm)
Floor Mounting Hole Location	23.28" (591.55mm)
UL Listed	1678

Optional Accessories

1" Deep Plexiglass Front Door	PFD44
1" Deep Solid Front Door	MPFD44
1" Deep Perforated Front Door	SFD44
3" Deep Perforated Front Door	N/A
Solid Top Panel	TPS-25
Perforated Top Panel	TPP-25
Fan Panel Top	EFT-25
Vented Side Panel	FMA44-25LRPV
Roller Cart / Caster Kit	FMARTK25
Additional Rack Rails	FMA-RRK44

FMA44-36G

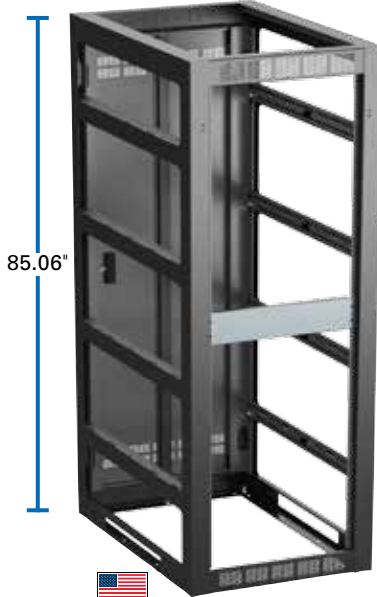

Specifications

Width (Outside)	24.12" (612.65mm)
Height (Outside)	85.06" (2160.59mm)
Depth (Outside)	30" (762mm)
Panel Space	44RU, 77.06" (1957.39mm)
Usable Depth	34" (863.6mm)
Top Panel Opening	18RU, 31.62" (803.285mm)
Floor Mounting Hole Location	33.78" (858.25mm)
UL Listed	1678

Optional Accessories

1" Deep Plexiglass Front Door	PFD44
1" Deep Solid Front Door	MPFD44
1" Deep Perforated Front Door	SFD44
3" Deep Perforated Front Door	N/A
Solid Top Panel	TPS-36
Perforated Top Panel	TPP-36
Fan Panel Top	EFT-36
Vented Side Panel	FMA44-36LRPV
Roller Cart / Caster Kit	FMARTK36
Additional Rack Rails	FMA-RRK44



700 Series racks were developed with a focus on premium construction and installer friendly features that allow for installation of heavy components with extended depths. Additionally the 700 Series can be fitted with a seismic bracing kit that meets GR-63-CORE standards where required.



744-25

19" Wide Opening Stand-Alone / Gangable Deep Floor Cabinet with Adjustable Rails, UL Listed

Applications

The Atlas 700 Series cabinets, designed for a high strength-to-weight ratio solution, are ideal for single and multi-bay applications where easy accessibility to wiring in and between racks is desirable. These cabinets are commonly used to house Data Center Equipment, Communications equipment, Audio Video equipment, Computer equipment, Broadcast equipment, Security systems, CCTV equipment, IT equipment, Industrial systems and Building Management Systems. These cabinets are built to Standard #EIA-310-C that meets most OEM, Commercial and Military application requirements.

Features

- UL 1678 Listed
- Optional Seismic Bracing Kit (Atlas Part Number SBK-700)
- Three Model Heights
- Optional Rear Door Offers Right- or Left-Hand Hinging Capability
- Threaded Hinge Inserts are Pre-Drilled on Both the Left and Right Sides of the Rack Allowing for Easy Installation with No Extra Drilling Required
- Up to 12RU (or Combinations to 12RU) (for 25½" Deep Models) Panel Opening in Top Offers Wiring Convenience or for Fan Panel Cooling with Optional EFP Series Fan Kits
- For 30" Deep Models: Up to 14RU (or Combinations to 14RU): Panel Opening in Top Offers Wiring Convenience or Fan Panel Cooling with Optional EFP Series Fan Kits
- Up to 18RU (or Combinations to 18RU) (for 36" Deep Models) Panel Opening in Top Offers Wiring Convenience or for Fan Panel Cooling with Optional EFT / EFP Series Fan Kits
- Increased Opening Base Facilitates Wiring Conduit or to Access Below Floor Raceways
- 3RU Galvanized Filler Panel (5¼") Provided
- Manufactured to E.I.A. Standards
- Pre-drilled to Accept M-1A Cabinet Mount IR Repeater
- Gangable Cabinet with Pre-Installed ¼-20 Thread Inserts to Gang Cabinets

General Description

These general purpose cabinets are 25½", 30", & 36" deep, 22⅝" wide, and available in three different RU heights. The 700 Series racks are completely welded 14-gauge CRS and assembled for immediate use. Optional rear doors can be hung with pre-installed quick-release spring hinges which allow them to be rotated 180° for right- or left-hand opening. See chart on back for appropriate front door, rear door, & side panel model numbers (ordered separately). Front doors are keyed differently than the rear door for security.

The 700 Series cabinet line includes an opening in the cabinet top which can left open for free wire access / ventilation, partially covered with the ISOPANEL™ for non-conductive cable access or closed using standard panels 12RU (for 25½" deep models), 14RU (for 30" deep models), or 18RU (for 36" deep models). Top opening is also perfect for installing EFP Series fan. Cabinets include two pairs of front-to-rear adjustable mounting rails tapped 10-32. Rails are standard E.I.A. ⅝"-⅝"-½" spacing. Cabinet surface is phosphate pre-treated for proper paint adhesion. Standard finish is textured black epoxy #962.



735-25

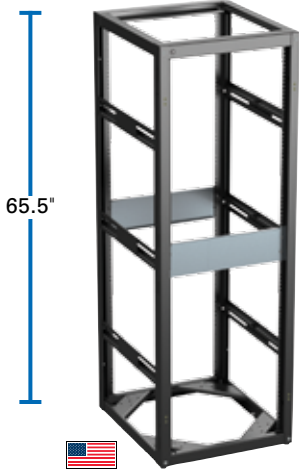

Specifications

Width (Outside)	22.3125" (567mm)
Height (Outside)	65.5" (1664mm)
Depth (Outside)	25.5" (648mm)
Panel Space	35RU, 61.25" (1556mm)
Usable Depth	23.53" (597mm)
Top Panel Opening	14RU, 24.5" (622mm)
UL Listed	1678

Optional Accessories

Flush Rear Door	FRD35
1" Deep Plexiglass Front Door	PFD35
1" Deep Solid Front Door	SFD35
1" Deep Perforated Front Door	MPFD35
3" Deep Perforated Front Door	MPFD35-3
Solid Top Panel	TPS-25
Perforated Top Panel	TPP-25
Fan Panel Top	EFT-25
Vented Side Panel	SPS35-25
Roller Cart / Caster Kit	RCK-700
Additional Rack Rails	RR35

740-25

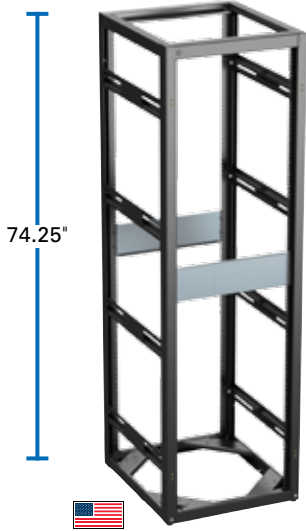

Specifications

Width (Outside)	22.3125" (567mm)
Height (Outside)	74.25" (1886mm)
Depth (Outside)	25.5" (648mm)
Panel Space	40RU, 70.125" (1778mm)
Usable Depth	23.53" (597mm)
Top Panel Opening	12RU, 21.06" (535mm)
UL Listed	1678

Optional Accessories

Flush Rear Door	FRD40
1" Deep Plexiglass Front Door	PFD40
1" Deep Solid Front Door	SFD40
1" Deep Perforated Front Door	MPFD40
3" Deep Perforated Front Door	N/A
Solid Top Panel	TPS-25
Perforated Top Panel	TPP-25
Fan Panel Top	EFT-25
Vented Side Panel	SPS40-25
Roller Cart / Caster Kit	RCK-700
Additional Rack Rails	RR40

744-25

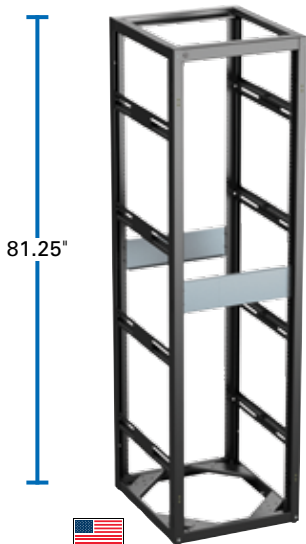

Specifications

Width (Outside)	22.3125" (567mm)
Height (Outside)	81.25" (2024mm)
Depth (Outside)	25.5" (648mm)
Panel Space	44RU, 77.125" (1956mm)
Usable Depth	23.53" (597mm)
Top Panel Opening	12RU, 21.06" (535mm)
UL Listed	1678

Optional Accessories

Flush Rear Door	FRD44
1" Deep Plexiglass Front Door	PFD44
1" Deep Solid Front Door	SFD44
1" Deep Perforated Front Door	MPFD44
3" Deep Perforated Front Door	N/A
Solid Top Panel	TPS-25
Perforated Top Panel	TPP-25
Fan Panel Top	EFT-25
Vented Side Panel	SPS44-25
Roller Cart / Caster Kit	RCK-700
Additional Rack Rails	RR44

744-30

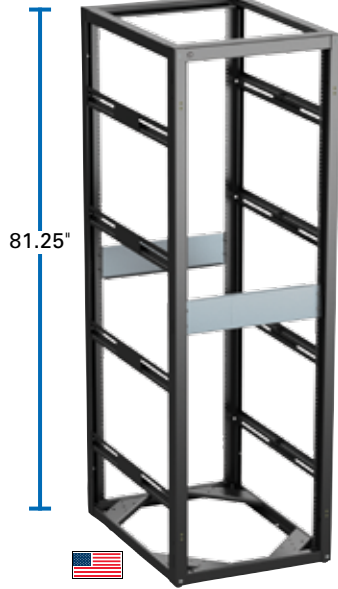

Specifications

Width (Outside)	22.3125" (567mm)
Height (Outside)	81.25" (2024mm)
Depth (Outside)	30" (762mm)
Panel Space	44RU, 77.125" (1956mm)
Usable Depth	28.0625" (713mm)
Top Panel Opening	14RU, 24.5" (622mm)
UL Listed	1678

Optional Accessories

Flush Rear Door	FRD44
1" Deep Plexiglass Front Door	PFD44
1" Deep Solid Front Door	SFD44
1" Deep Perforated Front Door	MPFD44
3" Deep Perforated Front Door	N/A
Solid Top Panel	TPS-30
Perforated Top Panel	TPP-30
Fan Panel Top	EFT-30
Vented Side Panel	SPS44-30
Roller Cart / Caster Kit	RCK-700
Additional Rack Rails	RR44*

*Model ships with two pairs of factory installed rails.

744-36

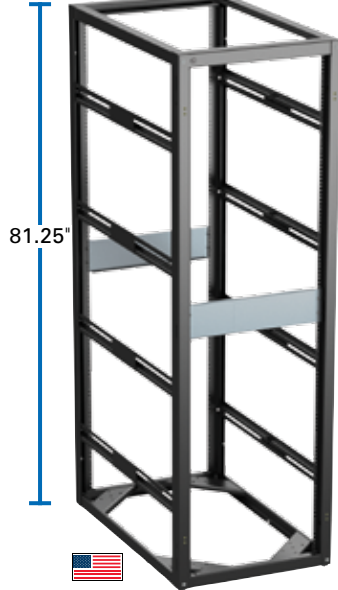

Specifications

Width (Outside)	22.3125" (567mm)
Height (Outside)	81.25" (2024mm)
Depth (Outside)	36.02" (915mm)
Panel Space	44RU, 77.125" (1956mm)
Usable Depth	34.03" (864mm)
Top Panel Opening	18RU, 31.62" (803mm)
UL Listed	1678

Optional Accessories

Flush Rear Door	FRD44
1" Deep Plexiglass Front Door	PFD44
1" Deep Solid Front Door	SFD44
1" Deep Perforated Front Door	MPFD44
3" Deep Perforated Front Door	N/A
Solid Top Panel	TPS-36
Perforated Top Panel	TPP-36
Fan Panel Top	EFT-36
Vented Side Panel	SPS44-36
Roller Cart / Caster Kit	RCK-700
Additional Rack Rails	RR44*

*Model ships with two pairs of factory installed rails.

SBK-700



Optional Seismic Bracket for 700 Series Racks

With the addition of optional Seismic Bracket, SBK-700, 700 Series racks can be certified in accordance to the Telcordia NEBS (Network Equipment Building Systems) GR-63-CORE standard. When the SBK-700 brackets are properly installed, the 700 Series successfully endured the rigorous real-world dynamic test - the racks are able to withstand up to a zone 4 earthquake which is comparable to Richter magnitude 8.0!

Certification Telcordia NEBS GR-63-CORE Standard





500 Series racks were developed to offer premium construction as well as installer friendly features that make installation easy. These features include an open design on all sides allowing access to the front and back of rack equipment and conduit arrays for wire management.

19" Wide Opening Stand-Alone / Gangable Floor Cabinet with Adjustable Rails, UL Listed

Applications

The Atlas 500 Series cabinets are ideal for single and multi-bay applications where easy accessibility to wiring in and between racks is desirable. These cabinets are commonly used to house Data Center Equipment, Communications equipment, Audio Video equipment, Computer equipment, Broadcast equipment, Security systems, CCTV equipment, IT equipment, Industrial systems and Building Management Systems.

Features

- UL1678 Listed
- Three Model Heights
- Rear Door Offers Right or Left-Hand Hinging Capability
- Threaded Hinge Inserts are Pre-Drilled on Both the Left and Right Sides of the Rack Allowing for Easy Installation with No Extra Drilling Required
- Up to 6RU (or Combinations to 6RU) Panel Opening in Top Offers Wiring Convenience or Fan Panel Cooling with Optional EFT / EFP Series Fan Kits
- Slotted Mounting Rail Supports Vertical Wire Management and are E.I.A. -Spaced for Vertical Mounting of 19" Accessories
- Increased Opening Base Facilitates Wiring to Conduit or to Access Below Floor Raceways
- Functional 3RU Blank Panel (5¼") Provided
- Manufactured to E.I.A. Standards
- Includes Perforated Front, Rear and Side Vents for Heat Dissipation
- Pre-drilled to Accept M-1A Cabinet Mount IR Repeater

General Description

The 500 Series cabinets are welded frames in 25½" or 30" depths available in three different RU heights, 35RU, 40RU and 44RU. The 500 Series cabinets are welded 16-gauge CRS and assembled for immediate use. Rear doors are hung with quick-release spring hinges which allow them to be rotated 180° for right- or left-hand opening. If front door is ordered, it will be keyed differently than the rear door for security. Cabinet frame and rear door are vented to promote air circulation and heat dissipation.

The 500 Series line offers several installer-friendly advantages including a 6RU standard panel width opening in the cabinet top and conduit arrays. The top opening can be left open for free wire access / ventilation, partially covered with the ISOPANEL™ for non-conductive cable access or closed using 2 standard 5¼" (3RU) panels. Top opening is also perfect for installing EFP Series fan. Multiple conduit arrays provide maximum access, and are conveniently located on the top and bottom panel surface and across the top and bottom back flanges of the cabinet frame. Surface arrays are comprised of 4 knockouts: two 1" (25mm) standard knockouts and two ½" (13mm) / ¾" (19mm) concentric. Flange arrays consist of five knockouts: three 1" (25mm) standard and two ½" (13mm) / ¾" (19mm) concentric.

Includes one pair of 12-gauge CRS adjustable mounting rails tapped 10–32 (544-30 includes 2 pair 12-gauge mounting rails) Cabinets have welded top and bottom panels with panel-opening vent; removable rear door with quick-release spring hinges, flush pull and cylinder lock.

Cabinets feature front-to-rear mounting rail supports with slotted cutouts to easily adjust rail depth and to provide open raceways for vertical cable pathway. Cabinet surface is phosphate pre-treated for proper paint adhesion. Standard finish is textured black epoxy #962.



544-30



535-25

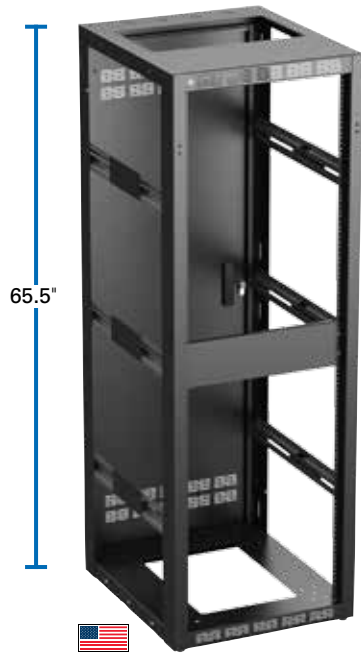

65.5"



Specifications

Width (Outside)	22.3125" (567mm)
Height (Outside)	65.5" (1664mm)
Depth (Outside)	25.5" (648mm)
Panel Space	35RU, 61.25" (1556mm)
Usable Depth	23.81" (605mm)
Top Panel Opening	6RU, 10.5" (266.7mm)
UL Listed	1678

Optional Accessories

1" Deep Plexiglass Front Door	PFD35
1" Deep Solid Front Door	SFD35
1" Deep Perforated Front Door	MPFD35
3" Deep Perforated Front Door	MPFD35-3
Solid Top Panel	SPR6
Perforated Top Panel	PPR6
Fan Panel Top	EFT6-4
Vented Side Panel**	SPS35-25
Roller Cart / Caster Kit	RCK-25
Additional Rack Rails	RR35

**Optional side panel lock also available. Model SP-LOCK

540-25



74.25"



Specifications

Width (Outside)	22.3125" (567mm)
Height (Outside)	74.25" (1886mm)
Depth (Outside)	25.5" (648mm)
Panel Space	40RU, 77.125" (1778mm)
Usable Depth	23.81" (605mm)
Top Panel Opening	6RU, 10.05" (266mm)
UL Listed	1678

Optional Accessories

1" Deep Plexiglass Front Door	PFD40
1" Deep Solid Front Door	SFD40
1" Deep Perforated Front Door	MPFD40
3" Deep Perforated Front Door	N/A
Solid Top Panel	SPR6
Perforated Top Panel	PPR6
Fan Panel Top	EFT6-4
Vented Side Panel**	SPS40-25
Roller Cart / Caster Kit	RCK-25
Additional Rack Rails	RR44

**Optional side panel lock also available. Model SP-LOCK

544-25



81.25"



Specifications

Width (Outside)	22.3125" (567mm)
Height (Outside)	81.25" (2024mm)
Depth (Outside)	25.5" (648mm)
Panel Space	44RU, 71.125" (1956mm)
Usable Depth	23.81" (605mm)
Top Panel Opening	6RU, 10.5" (267mm)
UL Listed	1678

Optional Accessories

1" Deep Plexiglass Front Door	PFD44
1" Deep Solid Front Door	SFD44
1" Deep Perforated Front Door	MPFD44
3" Deep Perforated Front Door	N/A
Solid Top Panel	SPR6
Perforated Top Panel	PPR6
Fan Panel Top	EFT6-4
Vented Side Panel**	SPS44-25
Roller Cart / Caster Kit	RCK-25
Additional Rack Rails	RR44

**Optional side panel lock also available. Model SP-LOCK

544-30



81.25"



Specifications

Width (Outside)	22.3125" (567mm)
Height (Outside)	81.25" (2024mm)
Depth (Outside)	30" (762mm)
Panel Space	44RU, 77.125" (1956mm)
Usable Depth	28" (711mm)
Top Panel Opening	6RU, 10.5" (267mm)
UL Listed	1678

Optional Accessories

1" Deep Plexiglass Front Door	PFD44
1" Deep Solid Front Door	SFD44
1" Deep Perforated Front Door	MPFD44
3" Deep Perforated Front Door	N/A
Solid Panel Top	SPR6
Perforated Top Panel	PPR6
Fan Panel Top	EFT6-4
Vented Side Panel**	SPS44-30
Roller Cart / Caster Kit	RCK-30
Additional Rack Rails	RR44*

*Ships with two pairs of factory installed rails.

**Optional side panel lock also available. Model SP-LOCK



200 Series racks were designed to offer both a great price but with the benefits and flexibility of a full featured rack. These economically priced units include the ability to add adjustable rails and horizontal hat sections to address the needs of any installation.



244-18

19" Wide Stand-Alone Floor Cabinet with Adjustable Rails, UL Listed

Applications

Atlas 200 Series floor cabinets are a flexible solution to house equipment for Government, Military, Commercial and Residential applications. These cabinets are commonly used to house Communications equipment, Audio Video equipment, Computer equipment, Broadcast equipment, Security systems, CCTV equipment, IT equipment, Industrial systems and Building Management Systems.

Features

- UL 1678 Listed
- Five Model Heights Available
- 18½", 25½" and 30" Depths Available
- Locking Rear Door Offers Right- or Left-Hand Hinging Capability
- Threaded Hinge Inserts are Pre-Drilled on Both the Left and Right Sides of the Rack Allowing for Easy Installation with No Extra Drilling Required
- Up to 6RU (or Combinations to 6RU) Panel Opening in Top Offers Wiring Convenience or Fan Panel Cooling with Optional EFP Series Fan Kits
- Open Base Facilitates Wiring to Conduit or Below Floor Raceways
- Functional 3RU Blank Panel (5¼") Provided on Models 35RU or Taller
- Manufactured to E.I.A. Standards
- Includes Perforated Front, Rear and Side Vents for Heat Dissipation
- Pre-drilled to Accept M-1A Cabinet Mount IR Repeater

General Description

The 200 Series cabinets are available in 18½", 25½", & 30" deep, 22⅝" wide, and available in five different RU heights, 21RU, 24RU, 35RU, 40RU and 44RU. (Refer to chart on back for exact dimensions and model numbers.) The 200 Series cabinets are welded 16-gauge CRS and assembled for immediate use.

Rear doors are hung with quick-release spring hinges which allow them to be rotated 180° for right- or left-hand opening. If front door is ordered, it will be keyed differently than the rear door for security.

The 200 Series cabinet line offers several installer-friendly advantages, including a 6RU standard panel width opening in the cabinet top and conduit arrays. The top opening can be left open for wire access and / or ventilation, partially covered with the ISOPANEL™ for non-conductive cable access or closed using 2 standard 5¼" (3RU) panels. Top opening is also perfect for installing EFP Series fan. Conduit arrays are located on the top and bottom surface panels, as well as the top and bottom back flanges. Flange arrays consist of five knockouts, three 1" (25mm) standard, and two, ½" (13mm) ¾" (19mm) concentric. Surface arrays are comprised of 4 knockouts: two 1" (25mm) standard knockouts and two ½" (13mm) ¾" (19mm) concentric.

Cabinets include one pair of front-to-rear adjustable mounting rails tapped 10-32. Channel slides provide adjustment (four per side on 44RU & 40RU models, three per side on 35RU models, and two per side on 24RU and 21RU models.) Rails are standard E.I.A. ⅝"-⅝"-½" spacing. Stamped, perforated vents are located on front, sides and rear door to allow for maximum air convection. Cabinet surface is phosphate pre-treated for proper paint adhesion. Standard finish is textured black epoxy #962.



221-18

41"



Specifications

Width (Outside)	22.3125" (567mm)
Height (Outside)	41" (1041mm)
Depth (Outside)	18.5" (470mm)
Panel Space	21RU, 36.75" (933mm)
Usable Depth	17" (432mm)
Top Panel Opening	6RU, 10.5" (266mm)
UL Listed	1678

Optional Accessories

1" Deep Plexiglass Front Door	PFD21
1" Deep Solid Front Door	SFD21
1" Deep Perforated Front Door	MPFD21
3" Deep Perforated Front Door	N/A
Solid Top Panel	SPR6
Perforated Top Panel	PPR6
Fan Panel Top	EFT6-4
Vented Side Panel	SPS35-25
Roller Cart / Caster Kit	CT1020-962
Additional Rack Rails	RR21

221-25

41"



Specifications

Width (Outside)	22.3125" (567mm)
Height (Outside)	41" (1041mm)
Depth (Outside)	25.5" (648mm)
Panel Space	21RU, 36.875" (937mm)
Usable Depth	24" (610mm)
Top Panel Opening	6RU, 10.5" (266mm)
UL Listed	1678

Optional Accessories

1" Deep Plexiglass Front Door	PFD21
1" Deep Solid Front Door	SFD21
1" Deep Perforated Front Door	MPFD21
3" Deep Perforated Front Door	N/A
Solid Top Panel	SPR6
Perforated Top Panel	PPR6
Fan Panel Top	EFT6-4
Roller Cart / Caster Kit	RCK-25
Additional Rack Rails	RR21

221-30

41"



Specifications

Width (Outside)	22.3125" (567mm)
Height (Outside)	41" (1041mm)
Depth (Outside)	30" (762mm)
Panel Space	21RU, 36.75" (933mm)
Usable Depth	28.563" (726mm)
Top Panel Opening	6RU, 10.5" (267mm)
UL Listed	1678

Optional Accessories

1" Deep Plexiglass Front Door	PFD21
1" Deep Solid Front Door	SFD21
1" Deep Perforated Front Door	MPFD21
3" Deep Perforated Front Door	N/A
Solid Top Panel	SPR6
Perforated Top Panel	PPR6
Fan Panel Top	EFT6-4
Roller Cart / Caster Kit	RCK-30
Additional Rack Rails	RR21

224-18

46.25"



Specifications

Width (Outside)	22.3125" (567mm)
Height (Outside)	46.25" (1175mm)
Depth (Outside)	18.5" (470mm)
Panel Space	24RU, 42" (1067mm)
Usable Depth	17" (432mm)
Top Panel Opening	6RU, 10.5" (266mm)
UL Listed	1678

Optional Accessories

1" Deep Plexiglass Front Door	PFD24
1" Deep Solid Front Door	SFD24
1" Deep Perforated Front Door	MPFD24
3" Deep Perforated Front Door	MPFD24-3
Solid Top Panel	SPR6
Perforated Top Panel	PPR6
Fan Panel Top	EFT6-4
Roller Cart / Caster Kit	CT1020-962
Additional Rack Rails	RR24

224-25

46.25"



Specifications

Width (Outside)	24.3125" (618mm)
Height (Outside)	46.25" (1175mm)
Depth (Outside)	25.5" (648mm)
Panel Space	24RU, 42" (1067mm)
Usable Depth	24" (610mm)
Top Panel Opening	6RU, 10.5" (266mm)
UL Listed	1678

Optional Accessories

1" Deep Plexiglass Front Door	PFD24
1" Deep Solid Front Door	SFD24
1" Deep Perforated Front Door	MPFD24
3" Deep Perforated Front Door	MPFD24-3
Solid Top Panel	SPR6
Perforated Top Panel	PPR6
Fan Panel Top	EFT6-4
Roller Cart / Caster Kit	RCK-250
Additional Rack Rails	RR24

224-30

46.25"



Specifications

Width (Outside)	22.3125" (567mm)
Height (Outside)	46.25" (1175mm)
Depth (Outside)	30" (762mm)
Panel Space	24RU, 42" (1067mm)
Usable Depth	28.56" (725mm)
Top Panel Opening	6RU, 10.5" (267mm)
UL Listed	1678

Optional Accessories

1" Deep Plexiglass Front Door	PFD24
1" Deep Solid Front Door	SFD24
1" Deep Perforated Front Door	MPFD24
3" Deep Perforated Front Door	MPFD24-3
Solid Top Panel	SPR6
Perforated Top Panel	PPR6
Fan Panel Top	EFT6-4
Roller Cart / Caster Kit	RCK-30
Additional Rack Rails	RR24

235-18



Specifications

Width (Outside)	22.3125" (567mm)
Height (Outside)	65.5" (1664mm)
Depth (Outside)	18.5" (470mm)
Panel Space	35RU, 61.25" (1556mm)
Usable Depth	17" (432mm)
Top Panel Opening	6RU, 10.5" (267mm)
UL Listed	1678

Optional Accessories

1" Deep Plexiglass Front Door	PFD35
1" Deep Solid Front Door	SFD35
1" Deep Perforated Front Door	MPFD35
3" Deep Perforated Front Door	MPFD35-3
Solid Top Panel	SPR6
Perforated Top Panel	PPR6
Fan Panel Top	EFT6-4
Roller Cart / Caster Kit	CT1020-962
Additional Rack Rails	RR35

235-25



Specifications

Width (Outside)	22.3125" (566mm)
Height (Outside)	65.5" (1664mm)
Depth (Outside)	25.5" (648mm)
Panel Space	35RU, 61.31" (1557mm)
Usable Depth	24" (610mm)
Top Panel Opening	6RU, 10.5" (267mm)
UL Listed	1678

Optional Accessories

1" Deep Plexiglass Front Door	PFD35
1" Deep Solid Front Door	SFD35
1" Deep Perforated Front Door	MPFD35
3" Deep Perforated Front Door	MPFD35-3
Solid Top Panel	SPR6
Perforated Top Panel	PPR6
Fan Panel Top	EFT6-4
Roller Cart / Caster Kit	RCK-25
Additional Rack Rails	RR35

235-30



Specifications

Width (Outside)	22.3125" (567mm)
Height (Outside)	65.5" (1664mm)
Depth (Outside)	30" (762mm)
Panel Space	35RU, 61.25" (1556mm)
Usable Depth	28.5625" (725mm)
Top Panel Opening	6RU, 10.5" (267mm)
UL Listed	1678

Optional Accessories

1" Deep Plexiglass Front Door	PFD35
1" Deep Solid Front Door	SFD35
1" Deep Perforated Front Door	MPFD35
3" Deep Perforated Front Door	MPFD35-3
Solid Top Panel	SPR-6
Perforated Top Panel	PPR-6
Fan Panel Top	EFT6-4
Roller Cart / Caster Kit	RCK-30
Additional Rack Rails	RR35

240-18



Specifications

Width (Outside)	22.3125" (567mm)
Height (Outside)	74.25" (1886mm)
Depth (Outside)	18.5" (470mm)
Panel Space	40RU, 70" (1778mm)
Usable Depth	17" (432mm)
Top Panel Opening	6RU, 10.5" (267mm)
UL Listed	1678

Optional Accessories

1" Deep Plexiglass Front Door	PFD40
1" Deep Solid Front Door	SFD40
1" Deep Perforated Front Door	MPFD40
3" Deep Perforated Front Door	N/A
Solid Top Panel	SPR6
Perforated Top Panel	PPR6
Fan Panel Top	EFT6-4
Roller Cart / Caster Kit	CT1020-962
Additional Rack Rails	RR40

240-25



Specifications

Width (Outside)	22.3125" (567mm)
Height (Outside)	74.25" (1886mm)
Depth (Outside)	25.5" (648mm)
Panel Space	40RU, 70.125" (1781mm)
Usable Depth	24" (610mm)
Top Panel Opening	6RU, 10.5" (267mm)
UL Listed	1678

Optional Accessories

1" Deep Plexiglass Front Door	PFD40
1" Deep Solid Front Door	SFD40
1" Deep Perforated Front Door	MPFD40
3" Deep Perforated Front Door	N/A
Solid Top Panel	SPR6
Perforated Top Panel	PPR6
Fan Panel Top	EFT6-4
Roller Cart / Caster Kit	RCK-25
Additional Rack Rails	RR40

240-30



Specifications

Width (Outside)	22.3125" (567mm)
Height (Outside)	74.25" (1886mm)
Depth (Outside)	30" (762mm)
Panel Space	40RU, 70" (1778mm)
Usable Depth	28.5625" (725mm)
Top Panel Opening	6RU, 10.5" (267mm)
UL Listed	1678

Optional Accessories

1" Deep Plexiglass Front Door	PFD40
1" Deep Solid Front Door	SFD40
1" Deep Perforated Front Door	MPFD40
3" Deep Perforated Front Door	N/A
Solid Top Panel	SPR6
Perforated Top Panel	PPR6
Fan Panel Top	EFT6-4
Roller Cart / Caster Kit	RCK-30
Additional Rack Rails	RR40

244-18

81.25"



Specifications

Width (Outside)	22.3125" (567mm)
Height (Outside)	81.25" (2064mm)
Depth (Outside)	18.5" (470mm)
Panel Space	44RU, 77" (1956mm)
Usable Depth	17" (432mm)
Top Panel Opening	6RU, 10.5" (267mm)
UL Listed	1678

Optional Accessories

1" Deep Plexiglass Front Door	PFD44
1" Deep Solid Front Door	SFD44
1" Deep Perforated Front Door	MPFD44
3" Deep Perforated Front Door	N/A
Solid Top Panel	SPR6
Perforated Top Panel	PPR6
Fan Panel Top	EFT6-4
Roller Cart / Caster Kit	CT1020-962
Additional Rack Rails	RR44

244-25

81.25"



Specifications

Width (Outside)	22.3125" (567mm)
Height (Outside)	81.25" (2064mm)
Depth (Outside)	25.5" (648mm)
Panel Space	44RU, 77" (1956mm)
Usable Depth	24" (610mm)
Top Panel Opening	6RU, 10.5" (266mm)
UL Listed	1678

Optional Accessories

1" Deep Plexiglass Front Door	PFD44
1" Deep Solid Front Door	SFD44
1" Deep Perforated Front Door	MPFD44
3" Deep Perforated Front Door	N/A
Solid Top Panel	SPR6
Perforated Top Panel	PPR6
Fan Panel Top	EFT6-4
Roller Cart / Caster Kit	RCK-25
Additional Rack Rails	RR44

244-30

81.25"



Specifications

Width (Outside)	22.3125" (567mm)
Height (Outside)	81.25" (2064mm)
Depth (Outside)	30" (762mm)
Panel Space	44RU, 77" (1956mm)
Usable Depth	28.5625" (725mm)
Top Panel Opening	6RU, 10.5" (267mm)
UL Listed	1678

Optional Accessories

1" Deep Plexiglass Front Door	PFD44
1" Deep Solid Front Door	SFD44
1" Deep Perforated Front Door	MPFD44
3" Deep Perforated Front Door	N/A
Solid Top Panel	SPR6
Perforated Top Panel	PPR6
Fan Panel Top	EFT6-4
Roller Cart / Caster Kit	RCK-30
Additional Rack Rails	RR44



100 Series racks were developed to provide a solution that meets the requirements of most basic installations. Utilizing a simple to install design with no unneeded features, the 100 Series is the ideal choice for addressing function and economy.



144-18

19" Wide Opening Stand-Alone Floor Cabinet with Fixed Rails, UL Listed

Applications

Atlas 100 Series floor cabinets are an affordable solution to house equipment for Government, Military, Commercial and Residential applications. These cabinets are commonly used to house Communications equipment, Audio Video equipment, Computer equipment, Broadcast equipment, Security systems, CCTV equipment, IT equipment, Industrial systems and Building Management Systems.

Features

- UL 1678 Listed
- Five Model Heights Available
- Locking Rear Door Offers Right- or Left-Hand Hinging Capability
- Threaded Hinge Inserts are Pre-Drilled on Both the Left and Right Sides of the Rack Allowing for Easy Installation with No Extra Drilling Required
- Up to 6RU (or Combinations to 6RU) Panel Opening in Top Offers Wiring Convenience or Fan Panel Cooling with Optional EFP Series Fan Kits
- Increased Opening in Base Facilitates Wiring to Conduit or Below Floor Raceways
- Functional 3RU Blank Panel (5¼") Provided on Models 35RU or Taller
- Manufactured to E.I.A. Standards
- Includes Perforated Front, Rear and Side Vents for Heat Dissipation
- Pre-Drilled to Accept M-1A Cabinet Mount IR Repeater

General Description

The 100 Series cabinets are 18½" deep, 22⅞" wide, and available in five different RU heights, 21RU, 24RU, 35RU, 40RU and 44RU. The cabinets are welded 16-gauge CRS and assembled for immediate use.

Rear doors are hung with quick-release spring hinges which allow them to be rotated 180° for right- or left-hand opening. Rear door includes flush door handle and cylinder lock. If front door is ordered, it will be keyed differently than the rear door for security.

The 100 Series cabinet line offers several installer-friendly advantages, including a 6RU standard panel width opening in the cabinet top and conduit arrays. The top opening can be left open for wire access and / or ventilation, partially covered with the ISOPANEL™ for non-conductive cable access or closed using 2 standard 5¼" (3RU) panels. Top opening is also perfect for installing EFP Series fan. Conduit arrays are located on the top and bottom surface panels, as well as the top and bottom back flanges. Flange arrays consist of five knockouts, three 1" (25mm) standard, and two, ½" (13mm) ¾" (19mm) concentric. Surface arrays are comprised of 4 knockouts: two 1" (25mm) standard knockouts and two ½" (13mm) ¾" (19mm) concentric.

Stamped, perforated vents are located on front, sides and rear door to allow for maximum air convection. Cabinets include one pair of 12-gauge, CRS fixed mounting rails tapped 10-32 and recessed ⅝" (16mm). Rails are standard E.I.A. spacing. Cabinet surface is phosphate pre-treated for proper paint adhesion. Standard finish is textured black epoxy #962.



Atlas Rack Loaded with AV Equipment



121-18

41"



Specifications

Width (Outside)	22.3125" (567mm)
Height (Outside)	41" (1041mm)
Depth (Outside)	18.5" (470mm)
Panel Space	21RU, 36.75" (933mm)
Usable Depth	17" (432mm)
UL Listed	1678

Optional Accessories

1" Deep Plexiglass Front Door	PFD21
1" Deep Solid Front Door	SFD21
1" Deep Perforated Front Door	MPFD21
3" Deep Perforated Front Door	NA
Solid Top Panel	SPR6
Perforated Top Panel	PPR6
Fan Panel Top	EFT6-4
Roller Cart / Caster Kit	CT1020-962

124-18

46.25"



Specifications

Width (Outside)	22.3125" (567mm)
Height (Outside)	46.25" (1175mm)
Depth (Outside)	18.5" (470mm)
Panel Space	24RU, 42" (1067mm)
Usable Depth	17" (432mm)
UL Listed	1678

Optional Accessories

1" Deep Plexiglass Front Door	PFD24
1" Deep Solid Front Door	SFD24
1" Deep Perforated Front Door	MPFD24
3" Deep Perforated Front Door	MPFD24-3
Solid Top Panel	SPR6
Perforated Top Panel	PPR6
Fan Panel Top	EFT6-4
Roller Cart / Caster Kit	CT1020-962

135-18

65.5"



Specifications

Width (Outside)	22.3125" (567mm)
Height (Outside)	65.5" (1664mm)
Depth (Outside)	18.5" (470mm)
Panel Space	35RU, 61.25" (1556mm)
Usable Depth	17" (432mm)
UL Listed	1678

Optional Accessories

1" Deep Plexiglass Front Door	PFD35
1" Deep Solid Front Door	SFD35
1" Deep Perforated Front Door	MPFD35
3" Deep Perforated Front Door	MPFD35-3
Solid Top Panel	SPR6
Perforated Top Panel	PPR6
Fan Panel Top	EFT6-4
Roller Cart / Caster Kit	CT1020-962

140-18



Specifications

Width (Outside)	22.3125" (567mm)
Height (Outside)	74.25" (1886mm)
Depth (Outside)	18.5" (470mm)
Panel Space	40RU, 70.0" (1778mm)
Usable Depth	17.0" (432mm)
UL Listed	1678

Optional Accessories

1" Deep Plexiglass Front Door	PFD40
1" Deep Solid Front Door	SFD40
1" Deep Perforated Front Door	MPFD40
3" Deep Perforated Front Door	N/A
Solid Top Panel	SPR6
Perforated Top Panel	PPR6
Fan Panel Top	EFT6-4
Roller Cart / Caster Kit	CT1020-962

144-18



Specifications

Width (Outside)	22.3125" (567mm)
Height (Outside)	81.25" (2024mm)
Depth (Outside)	18.5" (470mm)
Panel Space	44RU, 77.0" (1956mm)
Usable Depth	17.0" (432mm)
UL Listed	1678

Optional Accessories

1" Deep Plexiglass Front Door	PFD44
1" Deep Solid Front Door	SFD44
1" Deep Perforated Front Door	MPFD44
3" Deep Perforated Front Door	N/A
Solid Top Panel	SPR6
Perforated Top Panel	PPR6
Fan Panel Top	EFT6-4
Roller Cart / Caster Kit	CT1020-962



Technician Adjusting Parts for Metal Break Machine





WMA Series is the top of the line wall mount rack that offers superior construction and features to meet the needs of any wall mount installation. Designed with a separate back box section that can be installed during construction to mark the rack's location, the front section and accessories can then be installed when construction is finished.

19" Wide Opening Stand-Alone High Strength Wall Cabinet with Adjustable Rails, UL Listed

Applications

The WMA Series is a high strength cabinet used to house electronic equipment for any type of application, both commercial and residential, where a floor standing cabinet is not practical. Applications include Communications equipment, Audio Video equipment, Security systems, CCTV equipment, IT equipment, Industrial systems and Computer equipment.

Features

- UL Listed 1678
- Selection Includes Models with 18" Deep Center Mounting Sections Providing up to 23.5" of Usable Depth
- Top and Bottom Cutouts for Atlas Sound EFP Series Fans. (Ships with 3RU Blank Panels Installed)
- Internal Alignment Frame Provides Support Throughout Travel Range of Center Section
- Includes Perforated Front, Rear and Side Vents for Heat Dissipation
- Internal Bracing Provides Cable Management and Pass Thru's
- Adjustable Mounting Rails Provide Flexibility
- Rear Section Conduit and Rough-In Openings on Top, Bottom and Rear
- Mirror Image Lockable Rear Section Allows Left-or Right-Hinging of Center Section Regardless of Orientation, Often by One Person
- Threaded Hinge Inserts are Pre-Drilled on Both the Left and Right Sides of the Rack Allowing for Easy Installation with No Extra Drilling Required
- Rear Section Boxed Separately on Same Pallet with Center Section, Allows Contractor to Send Rear Section to Job Site for Rough In
- Finished in #962 Black Epoxy
- 12.5" x 12.5" Cut-Out On Back Pan Allows Easy Cable Access Through Mounting Surface
- Continuous Slot "Hat" Design Allows Full Front to Back Adjustment of Rack Rails. Securing Holes, Top and Bottom Provide Fixed Positioning of Rails
- Ships with One Set of Plated Rack Rails and (100) 1¹/₃₂" x .75" Rack Screws with Captive Washers
- Rails Include Hash Marks to Indicate Rack Unit Increments
- Side Lock Security System Provides an Easy Yet Secure Method of Joining Center Section to Back Pan
- Rear Section Includes Raised Mounting Embosses to Mount Power and Other Accessories



WMA10-23

General Description

The WMA Series wall cabinets are 16-gauge, welded with 18" deep center-section and adjustable mounting rails, and a 4 1/2" deep rear section. Panel space openings range from 10RU to 35RU. Cabinets are equipped with provisions for custom cabinet mounting, wire management, equipment mounting, and structural support. Cabinets are finished in a black electrostatic powder coat.

All models include adjustable front rack rails tapped 10-32, and manufactured to standard E.I.A. 1/2" spacing. Hat channels provide adjustable rack rail support with securing holes for fixed positioning of rails. Top and Bottom removable 3RU panels are located in the center section of the cabinet for EFP Series fan panels for further ventilation or for isolation panels for power.

The back face of the rear section is equipped with 1/4" deep boss detents which give Contractors field flexibility to install a custom plywood, aluminum, or steel sub-plate for mounting accessories inside the cabinet. Boss detents are on 12" centers. The rear section provides an interchangeable Right or Left hand cylinder lock for security. The cabinets have 16 conduit knockouts on the top of the rear section and 16 on the bottom of the rear section. Knockouts consist of two 1/2" (12.7mm) standard, three 1" (25mm) / 1 1/8" (34.9mm) concentric and four 1/2" (13mm) / 3/4" (19mm) concentric. Perforated vents, located on both sides (top and bottom) of the center section, provide ventilation for rack-mounted electronics. The cabinets offer a non-sagging design. The units' one-piece front and rear sections are strengthened with an internal alignment frame that supports the center section of the cabinet through its entire travel range.



WMA16-23

WMA10-23

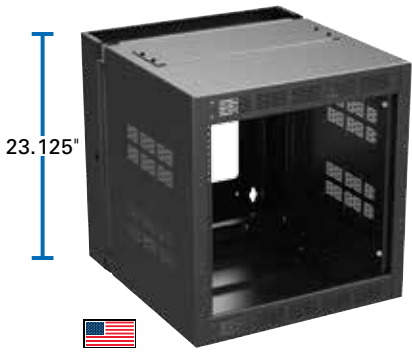

Specifications

Width (Outside)	21.875" (555.63mm)
Height (Outside)	23.125" (587.38mm)
Depth (Outside)	23.53" (597.66mm)
Panel Space	10RU, 17.5" (444.5mm)
Total Usable Depth	22.5" (571.5mm)
-Rack Usable Depth	18" (457.2mm)
-Rear Door Usable Depth	4.5" (114mm)
Usable Depth	18" (457.2mm)
Top Panel Opening	3RU, 5.25" (89mm)
UL Listed	1678

Optional Accessories

1" Deep Plexiglass Front Door	PFD10
1" Deep Solid Front Door	MPFD10
1" Deep Perforated Front Door	SFD10
3" Deep Perforated Front Door	MPFD10-3
Solid Top Panel	SPR3
Perforated Top Panel	PPR3
Fan Panel Top	EFP3-1, EFP3-2
Additional Rack Rails	WMA-RR10

WMA12-23

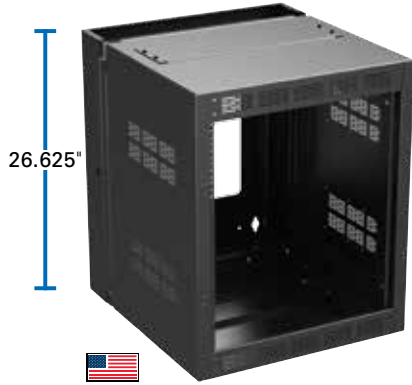

Specifications

Width (Outside)	21.875" (555.63mm)
Height (Outside)	26.625" (676.28mm)
Depth (Outside)	23.53" (597.66mm)
Panel Space	12RU, 21" (533mm)
Total Usable Depth	22.5" (571.5mm)
-Rack Usable Depth	18" (457.2mm)
-Rear Door Usable Depth	4.5" (114mm)
Top Panel Opening	3RU, 5.25" (89mm)
UL Listed	1678

Optional Accessories

1" Deep Plexiglass Front Door	PFD12
1" Deep Solid Front Door	MPFD12
1" Deep Perforated Front Door	SFD12
3" Deep Perforated Front Door	MPFD12-3
Solid Top Panel	SPR3
Perforated Top Panel	PPR3
Fan Panel Top	EFP3-1, EFP3-2
Additional Rack Rails	WMA-RR12

WMA16-23

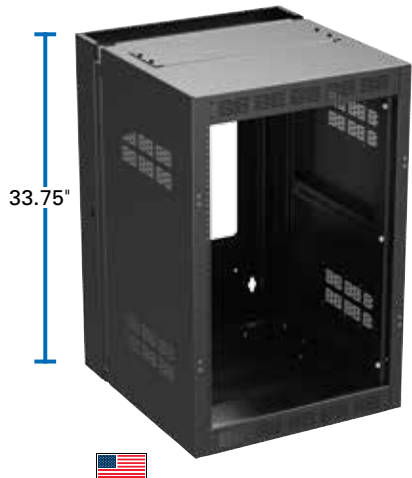

Specifications

Width (Outside)	21.875" (555.63mm)
Height (Outside)	33.75" (857.25mm)
Depth (Outside)	23.53" (597.66mm)
Panel Space	16RU, 28.125" (714.4mm)
Total Usable Depth	22.5" (571.5mm)
-Rack Usable Depth	18" (457.2mm)
-Rear Door Usable Depth	4.5" (114mm)
Top Panel Opening	3RU, 5.25" (89mm)
UL Listed	1678

Optional Accessories

1" Deep Plexiglass Front Door	PFD16
1" Deep Solid Front Door	MPFD16
1" Deep Perforated Front Door	SFD16
3" Deep Perforated Front Door	MPFD16-3
Solid Top Panel	SPR3
Perforated Top Panel	PPR3
Fan Panel Top	EFP3-1, EFP3-2
Additional Rack Rails	WMA-RR14

WMA24-23

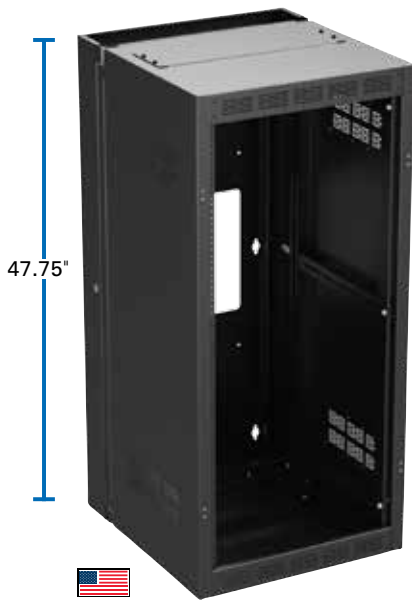

Specifications

Width (Outside)	21.875" (555.63mm)
Height (Outside)	47.75" (1212.85mm)
Depth (Outside)	23.53" (597.66mm)
Panel Space	24RU, 42.125" (1070mm)
Total Usable Depth	22.5" (571.5mm)
-Rack Usable Depth	18" (457.2mm)
-Rear Door Usable Depth	4.5" (114mm)
Top Panel Opening	3RU, 5.25" (89mm)
UL Listed	1678

Optional Accessories

1" Deep Plexiglass Front Door	PFD24
1" Deep Solid Front Door	MPFD24
1" Deep Perforated Front Door	SFD24
3" Deep Perforated Front Door	MPFD24-3
Solid Top Panel	SPR3
Perforated Top Panel	PPR3
Fan Panel Top	EFP3-1, EFP3-2
Additional Rack Rails	WMA-RR24

WMA35-23



Specifications

Width (Outside)	21.875" (555.63mm)
Height (Outside)	67" (1701.8mm)
Depth (Outside)	23.53" (597.66mm)
Panel Space	35RU, 61" (1549.4mm)
Total Usable Depth	22.5" (571.5mm)
-Rack Usable Depth	18" (457.2mm)
-Rear Door Usable Depth	4.5" (114mm)
Top Panel Opening	3RU, 5.25" (89mm)
UL Listed	1678

Optional Accessories

1" Deep Plexiglass Front Door	PFD35
1" Deep Solid Front Door	MPFD35
1" Deep Perforated Front Door	SFD35
3" Deep Perforated Front Door	MPRD35-3
Solid Top Panel	SPR3
Perforated Top Panel	PPR3
Fan Panel Top	EFP3-1, EFP3-2
Additional Rack Rails	WMA-RR35



Technician Programing TruLaser



300 Series racks were developed to offer the solid construction of an Atlas rack in a wall mountable design. These racks include many of the benefits found in Atlas floor standing racks but include wall mounting capability. 300 Series racks are available in several heights and depths making them versatile enough for installation from classrooms to full-scale AV closets.



307-12

19" Wide Opening Wall Cabinet with Adjustable Rails

Applications

The 300 Series is ideal to house electronic equipment for any type of application, both commercial and residential, where a floor standing cabinet is not practical. Applications include Communications equipment, Audio Video equipment, Security systems, CCTV equipment, IT equipment, Industrial systems and Computer equipment.

Features

- Sturdy Wall-Mount Cabinet Protects Equipment and Saves Valuable Floor Space
- Selection Includes Models With 12" and 15" Deep Center Mounting Sections
- Reinforced Frame Flanges, Plus Corner-Brace Structural Supports and Electric-Welded Seams & Miters Provide Stability for Mounted Equipment
- Punched Vents Assure Heat Dissipation
- Internal Wire Management Raceway
- Adjustable Mounting Rails Provide Flexibility Rear Section Conduit and Rough-In Openings
- Alignment Pins with Screw Type Locking Rods for Closure of Center Section

General Description

The 300 Series wall cabinets are welded with center-section depths of 12" and 15", respectively. Basic model includes three, 16-gauge CRS sections which include a 2" deep, solid-steel front door, a 12" or 15" deep center section with adjustable mounting rails, and a 4½" deep rear pan. Panel space openings range from 7 RU to 35 RU (depending on series - see chart on page 1). Enclosures are equipped with provisions for custom cabinet mounting, wire management, equipment mounting, and structural support (see below for detailed information). Cabinet is finished in #962 black epoxy.

All models include adjustable front rack rails tapped 10–32, and manufactured to standard E.I.A. ½" spacing. Models with RU openings of 16RU, 24RU and 35RU are equipped with center section mounting rail supports.

Internal open raceways provide cable pathways in the cabinet. Corner brace supports, which straddle the back and side panel of the rear section (hinge side), also feature round (1¼" diameter) wire access holes for harnessing excess wire. The back face of the rear section is equipped with ¼" deep boss detents which give Contractors field flexibility to install a custom plywood, aluminum, or steel sub-plate for mounting accessories inside the cabinet. Boss detents are on 12" centers and vary depending upon model height (10RU, 12RU, and 16RU models have four detents, 24RU models have six detents and 35RU models have eight detents).

The cabinets have 20 conduit knockouts on the rear section, with the exception of the 307-12 which has 16. Conduit arrays are located at the top and bottom of the back panel (except 307-12 which has a centered array), as well as on the top and bottom back flanges. Panel arrays consist of four knockouts: two 1" (25mm) standard and two ½" (13mm) / ¾" (19mm) concentric. Top and bottom flange arrays are comprised of six knockouts: three 1" (25mm) standard and three ½" (13mm) / ¾" (19mm) concentric.

Perforated vents, located on both sides (top and bottom) of the center section, provide ventilation for rack-mounted electronics. The cabinets offer exceptional structural support. The units' one-piece front and rear sections are strengthened with frame flanges on bottom, top, and sides. Center sections are plug-welded, joining bottom and top panels to side panels. Rear sections have corner brace supports which bridge the back and side panel (hinge side) giving the back (mounted) panel extra reinforcement for tension relief.

Cabinets also have electric-welded seams and miters which increases the cabinets' overall bonding. The center section offers maximum reinforcement provisions, such as a uniquely designed center section guide plate that reduces potential sagging by distributing cabinet and equipment weight to rear section. The 11-gauge, 1⅞" wide guide plate, which mounts to the rear section's bottom flange, provides a ¼" lip for added support to the center section when the cabinet is open or closed. The plate also ensures that an equipment-weighted center section will close properly, by "guiding" alignment pins into respective holes. An optional castor for carrying the weight of the center sections is available (Atlas CT31A).



310-15



316-12



307-12



Specifications

Width (Outside)	20.625" (524mm)
Height (Outside)	15.5" (393mm)
Depth (Outside)	18.5" (470mm)
Panel Space	7RU, 12.25" (311.2mm)
Usable Depth	12" (305mm)

Optional Accessories

Support Wheel	CT31A
Rear Rack Rails	—

310-12



Specifications

Width (Outside)	20.625" (524mm)
Height (Outside)	20.5" (521mm)
Depth (Outside)	18.5" (470mm)
Panel Space	10RU, 17.5" (445mm)
Usable Depth	12" (305mm)

Optional Accessories

Support Wheel	CT31A
Rear Rack Rails	RR310

312-12

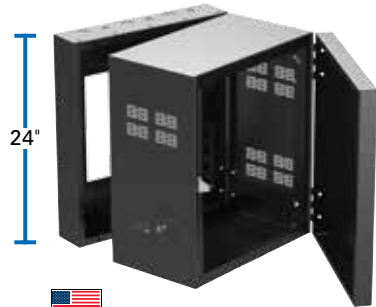

Specifications

Width (Outside)	20.625" (524mm)
Height (Outside)	24" (610mm)
Depth (Outside)	18.5" (470mm)
Panel Space	12RU, 21" (533.4mm)
Usable Depth	12" (305mm)

Optional Accessories

Support Wheel	CT31A
Rear Rack Rails	RR312

316-12

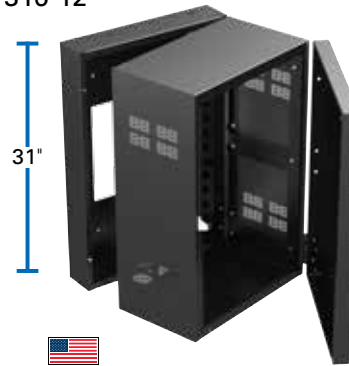

Specifications

Width (Outside)	20.625" (524mm)
Height (Outside)	31" (787mm)
Depth (Outside)	18.5" (470mm)
Panel Space	16RU, 28.125" (714mm)
Usable Depth	12" (305mm)

Optional Accessories

Support Wheel	CT31A
Rear Rack Rails	RR316

324-12



Specifications

Width (Outside)	20.625" (524mm)
Height (Outside)	45" (1143mm)
Depth (Outside)	18.5" (470mm)
Panel Space	24RU, 42.125" (1070mm)
Usable Depth	12" (305mm)

Optional Accessories

Support Wheel	CT31A
Rear Rack Rails	RR324

310-15



Specifications

Width (Outside)	20.625" (524mm)
Height (Outside)	20.5" (521mm)
Depth (Outside)	21.5" (546mm)
Panel Space	10RU, 17.5" (445mm)
Usable Depth	15" (381mm)

Optional Accessories

Support Wheel	CT31A
Rear Rack Rails	RR310

312-15



Specifications

Width (Outside)	20.625" (524mm)
Height (Outside)	24" (610mm)
Depth (Outside)	21.5" (546mm)
Panel Space	12RU, 21" (533mm)
Usable Depth	15" (381mm)

Optional Accessories

Support Wheel	CT31A
Rear Rack Rails	RR312

316-15

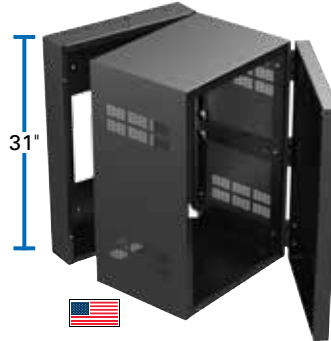

Specifications

Width (Outside)	20.625" (524mm)
Height (Outside)	31" (787mm)
Depth (Outside)	21.5" (546mm)
Panel Space	16RU, 28.125" (714mm)
Usable Depth	15" (381mm)

Optional Accessories

Support Wheel	CT31A
Rear Rack Rails	RR316

324-15



Specifications

Width (Outside)	20.625" (524mm)
Height (Outside)	45" (1143mm)
Depth (Outside)	21.5" (546mm)
Panel Space	24RU, 42.125" (1070mm)
Usable Depth	15" (381mm)

Optional Accessories

Support Wheel	CT31A
Rear Rack Rails	RR324

335-15



Specifications

Width (Outside)	20.625" (524mm)
Height (Outside)	64.25" (1632mm)
Depth (Outside)	21.5" (546mm)
Panel Space	35RU, 61" (1549mm)
Usable Depth	15" (381mm)

Optional Accessories

Support Wheel	CT31A
Rear Rack Rails	RR335



Completed Racks Being Prepped for Shipping



RX Series was developed to offer a high quality, secure, and mobile rack that can easily be transported from one location to another without having to remove the equipment.

19" Wide Opening Portable Floor Cabinet with Adjustable Rails and Casters

Applications

The RX Series is a high strength cabinet used to house electronic equipment for any type of application, both commercial and residential, where portability and freedom of movement are required. Applications include Communications equipment, Audio Video equipment, Security systems, IT equipment, Industrial systems and Computer equipment.

Features

- Two Model Heights and Depths Available
- Models with "SFD" suffix include Locking Solid Front Door
- 16-gauge CRS Frame Manufactured to E.I.A. Standards
- Four, 4" Heavy-Duty Casters (175 lb. cap. / ea.)
- Includes 1 Pair Adjustable, 12-gauge, Front-to-Rear Mounting Rails
- Mounting Rail Supports with Slotted Cut-Outs for Vertical Wire Management
- Rubber-Padded Steel Grip "Road Handles" (2 Per Side)
- Welded Frame for Long-Lasting Durability

Optional Accessories:

- RR Series Rack Rails
- Doors, Drawers, Shelves, Fans, and Accessories
- Lacing Bars
- Front Doors

General Description

RX Series portable cabinets are available in 25½" or 30" depths are 22⅝" wide and available in 14RU and 21RU heights. The cabinets are welded 16-gauge CRS with heavy-duty casters and are fully assembled for immediate use.

Each cabinet is equipped with one front pair of 12-gauge, CRS adjustable mounting rails tapped 10–32 on standard E.I.A. ⅝"- ⅝"-½" spacing. Front-to-rear mounting rail supports have slotted cutouts to easily adjust rail depth and to provide open raceways for containing vertically run wire and cable.

Cabinets feature one pair of recessed, hinged, and rubber-padded steel grips on each side (four total) for transport convenience. Easy wiring access is provided through three wire isolation holes (two, 1½" diameter, and one oblong 1½" x 3") in the rear base flange.

Each cabinet includes four, oversized, heavy-duty casters, two of which are locking, ensuring smooth mobility, and have a load capacity of 175 lb. each (700 lb. total).

Models with "SFD" suffix include locking solid front door and locking vented rear door.

Models without "SFD" suffix include locking vented rear door only to accommodate optional perforated or plexiglass front doors as required.

Cabinet is finished in textured black epoxy.



RX14-25SFD



RX21-25

RX14-25SFD



Specifications

Width (Outside)	22.3125" (567mm)
Height (Outside)	33.5625" (853mm)
Depth (Outside)	25.5" (648mm)
Panel Space	14RU, 24.5" (622.3mm)
Usable Depth	24" (607mm)

Optional Accessories

Additional Rack Rails	RR14
-----------------------	------

RX14-25



Optional Accessories

1" Deep Plexiglass Front Door	PFD14
1" Deep Solid Front Door	SFD14
1" Deep Perforated Front Door	MPFD14

RX14-30SFD



Specifications

Width (Outside)	22.3125" (567mm)
Height (Outside)	33.5625" (853mm)
Depth (Outside)	30" (762mm)
Panel Space	14RU, 24.5" (622.3mm)
Usable Depth	28.5" (724mm)

Optional Accessories

Additional Rack Rails	RR14
-----------------------	------

RX14-30



Optional Accessories

1" Deep Plexiglass Front Door	PFD14
1" Deep Solid Front Door	SFD14
1" Deep Perforated Front Door	MPFD14

RX21-25SFD

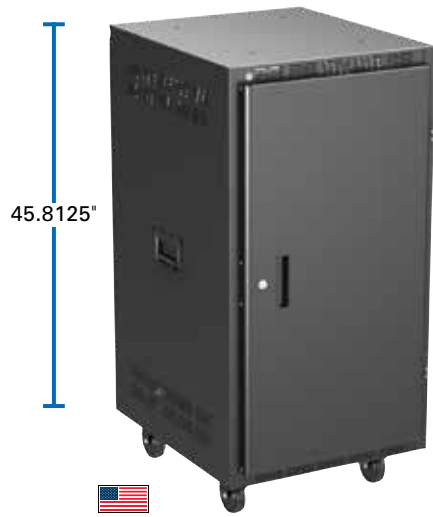

Specifications

Width (Outside)	22.3125" (567mm)
Height (Outside)	45.8125" (1164mm)
Depth (Outside)	25.5" (648mm)
Panel Space	21RU, 36.75" (933mm)
Usable Depth	24" (607mm)

Optional Accessories

Additional Rack Rails	RR21
-----------------------	------

RX21-25



Optional Accessories

1" Deep Plexiglass Front Door	PFD21
1" Deep Solid Front Door	SFD21
1" Deep Perforated Front Door	MPFD21

RX21-30SFD

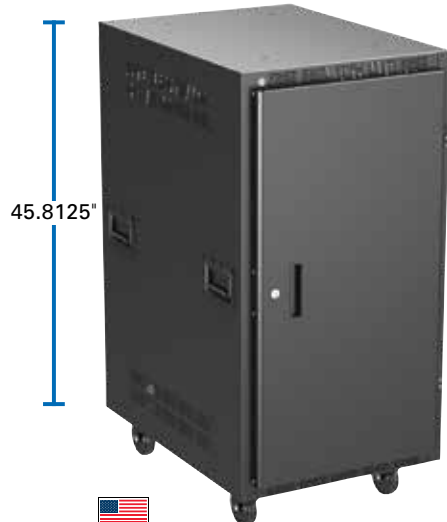

Specifications

Width (Outside)	22.3125" (567mm)
Height (Outside)	45.8125" (1164mm)
Depth (Outside)	30" (762mm)
Panel Space	21RU, 36.75" (933mm)
Usable Depth	28.5" (724mm)

Optional Accessories

Additional Rack Rails	RR21
-----------------------	------

RX21-30



Optional Accessories

1" Deep Plexiglass Front Door	PFD21
1" Deep Solid Front Door	SFD21
1" Deep Perforated Front Door	MPFD21



400 Series racks were designed to be used in applications where floor standing and wall mounting installation options are not available. These enclosures include the same high quality construction as other Atlas racks but are designed for tabletop installation of control or monitoring equipment.



407-15
Shown with Optional Front Door, SFD407



418-15
Shown with Optional Front Door, SFD418

19" Wide Opening Desktop Cabinet with Fixed Rails

Applications

Atlas 400 Series desktop cabinets are an affordable solution to house equipment for Government, Military, Commercial and Residential applications. These cabinets are commonly used to house Communications equipment, Audio Video equipment, Computer equipment, Broadcast equipment, Security systems, CCTV equipment, IT equipment, Industrial systems, and Building Management Systems.

Features

- Five Model Heights Available
- 16-gauge CRS Cabinet
- EIA Standard Panel Mount Spacing
- 5/8" Offset Front Rack Rails for Panel Mount
- 12-gauge CRS Tapped Mounting Rails
- Locking Rear Door Offers Right- or Left-Hand Hinging Capability
- Spring-Loaded Hinge for Easy Removal of Rear Door
- Keyed Cylinder Lock on Rear Door
- Includes Perforated Side Vents for Heat Dissipation
- Optional Front Surface Door has Right or Left-Hand Hinging Capability

Options

- Solid Front Door
- Drawers, Shelves, Fans, and Accessories
- Lacing Bars and Bus Bars

General Description

Atlas Sound 400 Series cabinets are 15 3/8" deep cabinets designed for "desk top" installations available in five different RU heights, 7RU, 10RU, 12RU, 14RU and 18RU. The 400 Series cabinets are constructed of welded 16-gauge CRS throughout. The side panels are vented to promote air circulation and heat dissipation. A locking rear door mounted on a spring-loaded hinge for easy removal is standard on all models.

The 400 Series cabinets are shipped completely assembled. The cabinets come with 10-32 x 3/4" pan-head screws. Rails are formed from 12-gauge CRS with tapped mounting holes. Panel mounting rails are recessed 5/8" to provide a flush appearance. External wiring is easily strung into the cabinet through the wire entry space below the rear door or panel. Standard finish is textured black epoxy.

A wide variety of convenience and electronic accessories are available for the 400 Series cabinets. An optional Left or Right hand hinging solid front door, Model SFD4xx is available. The door is installed by the customer using the simple drilling template included with the cabinet.



Welding Assembly in our Ennis, TX Facility



407-15



Shown with Optional Front Door, SFD407

Specifications

Width (Outside)	22.125" (561mm)
Height (Outside)	15.5" (394mm)
Depth (Outside)	15.375" (391mm)
Panel Space	7RU, 12.25" (311mm)
Usable Depth	14.125" (359mm)

Optional Accessories

1" Deep Solid Front Door SFD407

410-15



Shown with Optional Front Door, SFD410

Specifications

Width (Outside)	22.125" (561mm)
Height (Outside)	15.5" (394mm)
Depth (Outside)	15.375" (391mm)
Panel Space	10RU, 17.5" (445mm)
Usable Depth	14.125" (359mm)

Optional Accessories

1" Deep Solid Front Door SFD410

412-15



Shown with Optional Front Door, SFD412

Specifications

Width (Outside)	22.125" (561mm)
Height (Outside)	24.25" (616mm)
Depth (Outside)	15.375" (391mm)
Panel Space	12RU, 21" (533.4mm)
Usable Depth	14.125" (359mm)

Optional Accessories

1" Deep Solid Front Door SFD412

414-15



Shown with Optional Front Door, SFD414

Specifications

Width (Outside)	22.125" (561mm)
Height (Outside)	27.75" (705mm)
Depth (Outside)	15.375" (391mm)
Panel Space	14RU, 24.5" (622.3mm)
Usable Depth	14.125" (359mm)

Optional Accessories

1" Deep Solid Front Door SFD414

418-15

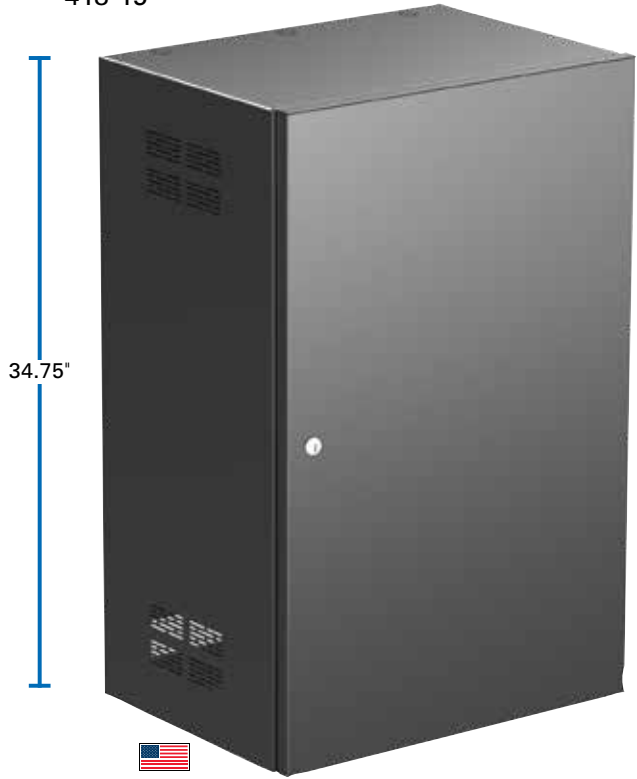

Shown with Optional Front Door, SFD418

Specifications

Width (Outside)	22.3125" (567mm)
Height (Outside)	34.75" (883mm)
Depth (Outside)	15.375" (391mm)
Panel Space	18RU, 31.5" (800mm)
Usable Depth	14.125" (359mm)

Optional Accessories

1" Deep Solid Front Door SFD418



TruLaser Beginning Sheet Metal Cutting Process



600 Series racks were developed for wall mount installations that include only a few pieces of equipment but where the security of a locking door is required to prevent unauthorized tampering.

19" Wide Opening Stand Alone Basic Wall Cabinet

Applications

The 600 Series is a basic cabinet used to house electronic equipment for any type of application, both commercial and residential, where a floor standing cabinet is not practical. Applications include Communications equipment, Audio Video equipment, Security systems, CCTV equipment, IT equipment, Industrial systems and Computer equipment.

Features

- 16-gauge CRS All Welded Construction with 11-gauge CRS Tapped Mounting Rails
- Locking Front Door
- Vents on Each Side
- 10-32 Pan Head Screws for Panel Mounting
- Completely Assembled
- Convenient Pre-Punched Back Panel for Wall Mounting

Options

- Drawers, Shelves, Fans, and Accessories

General Description

Atlas Sound Model 607-15 is a surface mounting wall cabinet used for housing small electronic system installations including 19" wide amplifiers, tuners and associated communication controls for schools, churches, clubs and recreation facilities. The 607-15 has a vertical panel opening of 12 3/8" (314mm) and is constructed of 16-gauge CRS.

Louvers on each side of the cabinet are provided for ventilation. The 11-gauge CRS panel mounting rails are recessed 5/8" (16mm) for a "flush" look. Locking front door is standard. Panel-mounting screws (10-32 x 3/4") are provided for equipment panel and accessory mounting. Mounting rails are tapped 10-32 on EIA spacing. Three double 1/2" (13mm) and 3/4" (19mm) knockouts are provided on the top and bottom of the cabinet for wire entry. Four keyhole slots for wall hanging are provided on the back panel. The 607-15 is shipped completely assembled and is finished in (#962) black epoxy powder coat.

607-15



Specifications

Width (Outside)	22.3125" (567mm)
Height (Outside)	15.5" (394mm)
Depth (Outside)	15.375" (391mm)
Panel Space	7RU 12.25" (311mm)
Usable Depth	14.75" (375mm)



Sharpening the Tool For The Punch Press Before Starting Production



900 Series racks were designed for convenient, flat pack shipping and simple, easy to install construction. The 900 Series can be used as stand alone units or they can be joined together to create a custom size rack based on the requirements of the installation.

19" Wide Opening Stackable Utility Frame

Features

- Unique Rack Engineered for Assembled Strength and Simple Assembly
- Open Frame Design Facilitates Mounting All Types of Equipment
- Packaged for Fast and Reduced Cost Shipping and Compact Storage
- Frames Easily Bolt Together to Accommodate Vertical or Horizontal Racking Needs
- Ideal Cabinet Frame for Economy and Durability in "Behind The Scenes" Applications
- Includes Front and Rear Mounting Rails

Applications

900 Series frames are uniquely engineered to provide assembled strength and shipping / storage economy. These low-cost, innovative units feature quick and simple assembly, and the versatility of the 900 Series allows the frames to be easily stacked for increased vertical space or joined side-by-side for mounting electronics in either free-standing or custom cabinet enclosures.

These frames, which are available in both a 12RU (912-18) and a 16RU (916-18) version, are ideal for theater, residential, broadcast, and retail applications where easy access to equipment mounted behind-the-scenes or under desks / counters is desired. The frames of the 900 Series are intended for permanent installation where doors, side panels, and casters are not required. 900 Series models are offered with 10-32 tapped rails.

General Description

The 900 Series frames are offered in two models, 912-18 which is 12RU high with 17½" (445mm) panel space and 916-18 which is 16RU high with 26¼" (667mm) panel space when the optional top horizontal cross member is removed.

The corner post rails are manufactured of 11-gauge CRS, drilled and tapped for EIA mounting. Three left-to-right horizontal frame members are 14-gauge CRS and offer cutouts for easy wire access and ¼" holes for bolting to floors (if desired). Cutouts can also be used as handles or wire access holes, and may be installed facing up, down, front, or rear. The fourth horizontal frame member is a standard 16-gauge CRS, blank panel measuring 3½" (2RU). The front-to-rear (side) frame members are 16-gauge CRS to provide structural rigidity and to serve as splice plates when joining 900 Series units in stacked configurations. They also are equipped with wire tie holes for wire management.

Units are finished and stocked in textured black epoxy. Entire frame assemblies are shipped knocked-down with hardware bag, that contains black assembly screws and washers as well as 40 extra sets of screws for mounting equipment.

Units can easily be vertically stacked by stacking the rail members and joining them using the front-to-rear members as splice plates. (All necessary hardware is furnished.) Various heights can be achieved by stocking the multiple units on top of each other 12RU and 16RU. Units can also be joined "side-by-side" using the pre-drilled holes in the front-to-rear frame members and owner-supplied hardware.

912-18

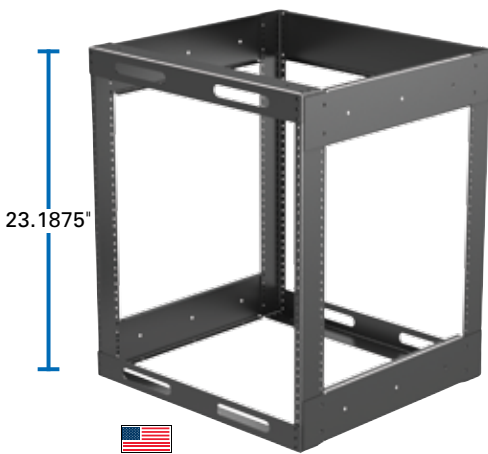

Specifications

Width (Outside)	19.24" (489mm)
Height (Outside)	23.1875" (589mm)
Depth (Outside)	18" (457mm)
Panel Space	12RU, 21" (533mm)
Usable Depth	14.75" (375mm)

916-18

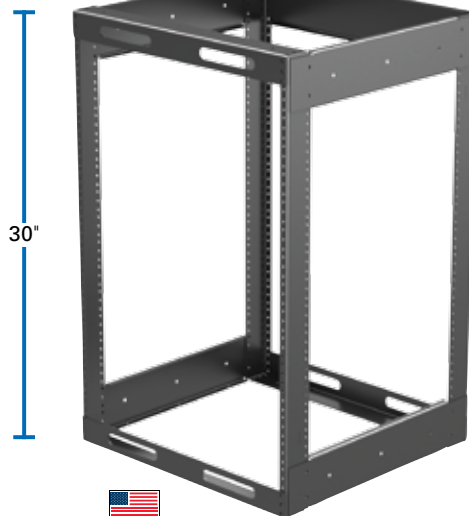

Specifications

Width (Outside)	19.24" (489mm)
Height (Outside)	30" (762mm)
Depth (Outside)	18" (457mm)
Panel Space	16RU, 28" (711mm)
Usable Depth	14.75" (375mm)





AWR Series was developed to offer a secure mounting location for equipment that would not take up any space on the floor or wall. These tilt out racks are ideal for use in classrooms, boardrooms, and other installations where limited equipment is required and limited space is available.

19" Wide Opening Tilt-Out Wall Cabinets

Features

- The AWR Series Provides Safety, Security, and Protection for Rack Mount Gear in Commercial Applications
- The AWR Series Includes a Highly Adaptable 3RU Front Access Panel Which is Great for "User Accessible" Electronics
- Adapt the AWR Series to Most Any Wall Surface with the Attractive Flush Mount Trim Ring (Included)

Applications

Atlas Sound AWR Series is a high strength tilt-out cabinet used to house electronic equipment for both commercial and residential applications where a small footprint and minimal footprint are required. Applications include communications equipment, A/V equipment, Security systems, IT equipment, and Industrial.

General Description

AWR Series tilt-out cabinets offer convenient access and lock-in security in 2RU (AWR2W) and 3RU (AWR3W) models. These welded models can be surface or recess mounted (trim ring included) and include a 3RU panel opening above the main bay for connector panels or power distribution with a usable depth of 4" for the AWR2W and 5.75" for the AWR3W. These cabinets are perfect for mounting remote amplifiers and control equipment.

The series features a 16-gauge CRS formed door frame with a 16-gauge CRS locking tilt-out door which closes against rack face plate. The surface mounting door is attached to the frame internally with 2 pin style hinges to prevent tampering.

Doors can be opened to two positions—tilt-out for operation and by releasing side catches, the door will open to approximately 90° for equipment installation and maintenance. Units are furnished with two steel safety catch cables which suspend and hold doors at 90°.

Front panels have 45-degree mitered edges to present a clean flush appearance. Back box is 16-gauge CRS equipped with six concentric knockouts of 1/2" and 3/4". AWR Series is shipped complete and ready for installation. Panel mounting holes accept 10-32 hardware.

AWR2W

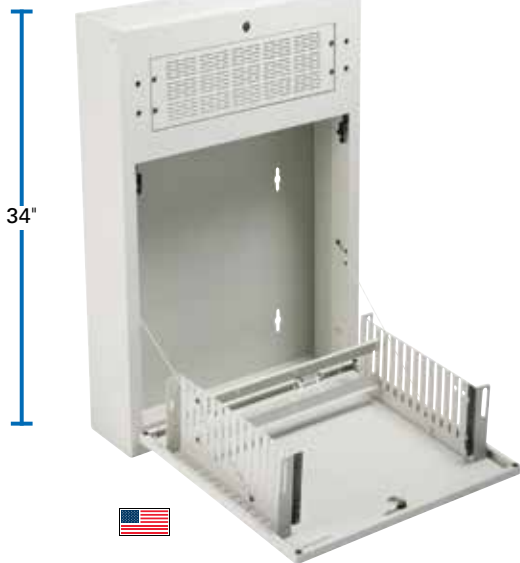

Specifications

RU	2RU
Width (Outside)	27" (686mm)
Height (Outside)	34" (863mm)
Depth (Outside)	4.8" (121mm)
Usable Depth	20" (508mm)
Usable Depth (Bottom RU)	17.25" (438mm)

AWR3W

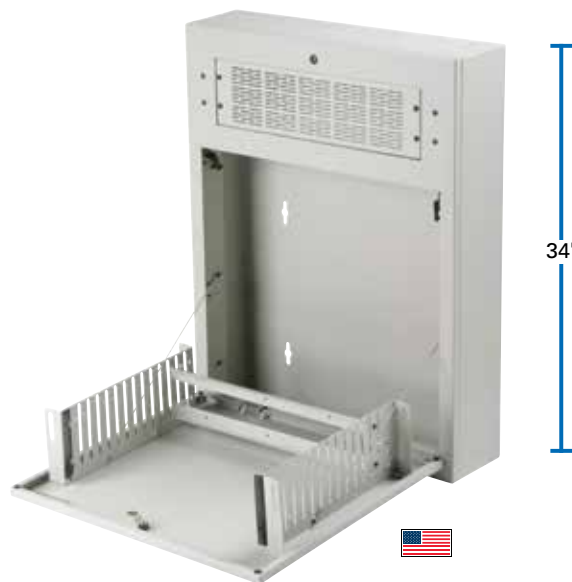

Specifications

RU	3RU
Width (Outside)	27" (686mm)
Height (Outside)	34" (863mm)
Depth (Outside)	6.55" (167mm)
Usable Depth	20" (508mm)
Usable Depth (Bottom RU)	17.25" (438mm)



Atlas Sound is always looking for innovative solutions to solve problems faced by integrators every day. The new WMA and AWR half rack solutions from Atlas Sound are designed to address small space installations where rack accessibility is important.

Half Rack Wide Wall Mount Cabinets

Features

- Wall Mount
- Designed Specifically to Accommodate Half Rack Width Components
- 16 Gauge CRS Construction
- Finished in Black Electrostatic Powder Coat
- Adaptor Available for Vertical Mounting of Full Rack Width Components

Applications

Atlas Sound half rack units are a unique solution that offers integrators a solution for challenging installation scenarios. The unique swing down design makes these racks ideal for small equipment closets or as space saving options in offices, retail stores, industrial complexes, education facilities, and any installation where space is a premium.

General Description

WMA Half Racks

The Atlas Sound WMA12-19-HR and WMA16-19-HR are wall mounted racks designed to accommodate mounting of half rack width components or vertical mounting of 19" rack width components. Additionally, these models feature a unique, patent pending swing down design that enables an integrator or contractor to access the back of the rack for easy connection and wire management of installed components. Models include front, adjustable 12-gauge CRS rack rails tapped at 10-32 and are equipped with provisions for wire management, equipment mounting, and structural support. Top and bottom removable 3RU panels are located in the center section of the cabinet for the optional EFP3-HR fan panel for further ventilation. Perforated vents, located on both sides (top and bottom) of the center section, provide ventilation for rack-mounted electronics. Each model is constructed in our Ennis, TX facility using durable 16-gauge CRS that is finished in a black electrostatic powder coat.

WMA12-19-HR

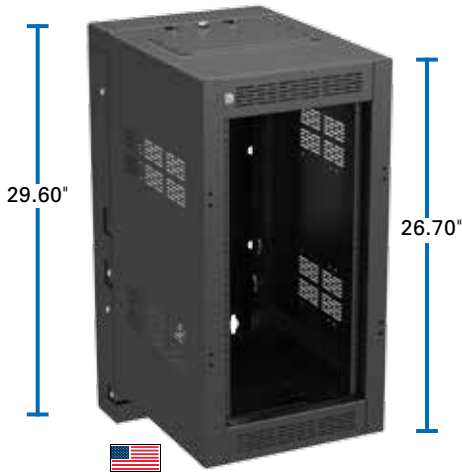

Specifications

Width (Outside)	13.79" (350mm)
Height (Outside)	26.70" (678mm)
Back Box Height (Outside)	29.60" (678mm)
Depth (Outside)	
Panel Space	7RU, 21.25" (539mm)
Usable Depth	15.50"
Total Depth	19.10"

Optional Accessories

Blank Panels	CB1-HR
	CB2-HR
	CB3-HR
Solid Flanged Panels	SPR1-HR
	SPR2-HR
	SPR3-HR
Perforated Panels	PPR1-HR
	PPR2-HR
	PPR3-HR

WMA16-19-HR

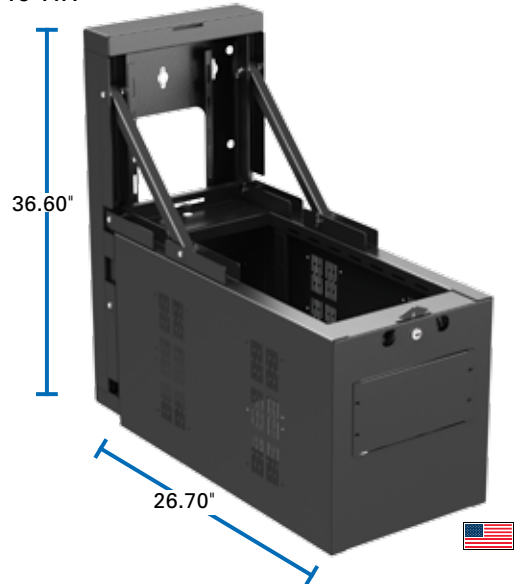

Specifications

Width (Outside)	13.79" (350mm)
Height (Outside)	33.70" (678mm)
Back Box Height (Outside)	36.60" (678mm)
Depth (Outside)	
Panel Space	7RU, 21.25" (539mm)
Usable Depth	15.50"
Total Depth	19.10"

Optional Accessories

Blank Panels	CB1-HR
	CB2-HR
	CB3-HR
Solid Flanged Panels	SPR1-HR
	SPR2-HR
	SPR3-HR
Perforated Panels	PPR1-HR
	PPR2-HR
	PPR3-HR



AWR Half Racks

Additionally, Atlas offers an in-wall half rack unit, model AWR2W-HR and AWR3W-HR. This convenient access, lock-in security, and welded model can be surface or recessed mounted. Both AWR models are designed to install within standard 16" stud wall construction, reducing installation time and the need to cut and repair dry wall. The AWR series features a 18-gauge CRS formed door frame with a 18-gauge CRS locking tilt-out door which closes flush against the rack face plate. The surface mount door is attached to the frame internally with 2 pin style hinges to prevent tampering.

The door can be opened to two positions, tilt-out for operation, and by releasing side catches, the door will open to approximately 90° for equipment installation and maintenance. Units are furnished with two steel safety catch cables that suspend and hold doors at 90°. The back box is 18-gauge CRS and is equipped with six eight concentric ½" and ¾" conduit knockouts. The 12-gauge CRS Rack rail mounting holes accept 10-32 hardware.

AWR2W-HR



Specifications

RU	2RU
Width (Outside)	14.38" (365mm)
Height (Outside)	22" (559mm)
Depth (Outside)	5.7" (121mm)

AWR3W-HR

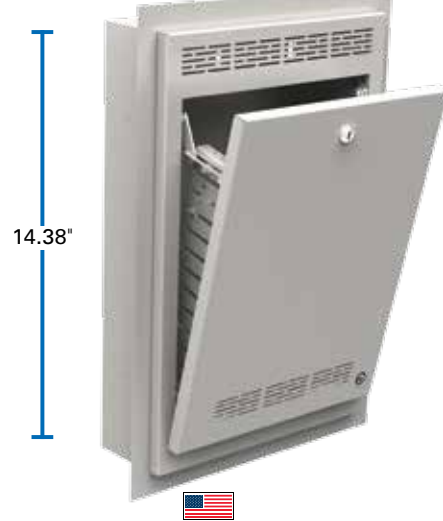

Specifications

RU	3RU
Width (Outside)	14.38" (686mm)
Height (Outside)	22" (863mm)
Depth (Outside)	7.45" (167mm)

Half Rack Accessories

Atlas offers an assortment of rack accessories to use with both the WMA and AWR half rack series. Both vented and blank panels are available, in 1RU, 2RU, and 3RU sizes. The EFP3-1-HR is a fan panel designed to integrate into the top or bottom of the rack cabinet or any half rack position. The SH1-10-HR is a 1RU half-rack shelf and for installations that require full rack width components, the VRK-HR is an adaptor that allows integrators and system designers to install 19" wide components vertically in the half rack. Both solid, SFP, and perforated, MPFD, doors are available for security.

Other Accessories

Vertical 19" Mounting Adapter	VRK-HR
Half Rack Fan Panel	EFP3-1-HR
1RU Half Rack Shelf	SH1-10-HR



EFP3-11HR

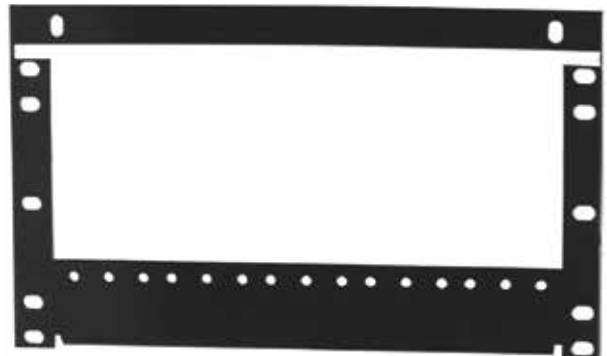

VRK-HR



Atlas Rack Panels

Choose from a variety of panels to enclose unfilled space and to provide aesthetic continuity and security in 19" electronic equipment cabinets. Solid & perforated models offer dust protection and heat ventilation. All models include oblong mounting holes on E.I.A. universal spacing for adjustment flexibility.

CB Series

Economy solid steel panels are constructed of 14-gauge steel finished in attractive -052 flat black electrostatic powdercoat. Available in 1RU, 2RU, 3RU, & 4RU Heights. 1RU Model, CB1, also available in a 12 piece Bulk Pack, CB1-BP12.

SPR / SPF Series

Solid 16-gauge CRS blank panels are available in a selection of recessed and flush mounting models. SPR Series has formed returns on panel top and bottom for recessed installation. SPF Series are formed on all four sides to exhibit a flush-to-frame appearance. Recessed available in 1RU to 8RU heights. Flush available in 2RU.

PPR / PPF Series

Perforated 22-gauge CRS vent panels provide for natural air circulation and dissipation of equipment generated heat. PPR Series is formed on panel top and bottom for recessed installation. PPF Series is formed on four sides to achieve a flush-to-frame appearance. Recessed available in 1RU to 8RU heights. Flush available in 2RU.

SEC Series Security Covers

Designed to eliminate unauthorized operator tampering to rack mount equipment such as equalizers and rack mount mixers. These 22-gauge construction covers feature fine perforated steel insert for good visibility. Unique radiused corners provide a professional looking installation. Formed edges protect equipment from scratches. Available in 1RU, 2RU, & 3RU heights.

TPS / TPP Series

Top panels for FMA Series & 700 Series. Available as solid (TPS Series) and perforated (TPP Series). Available in 12RU, 14RU, & 18RU heights for 25½", 30", & 36" depth racks, respectively.

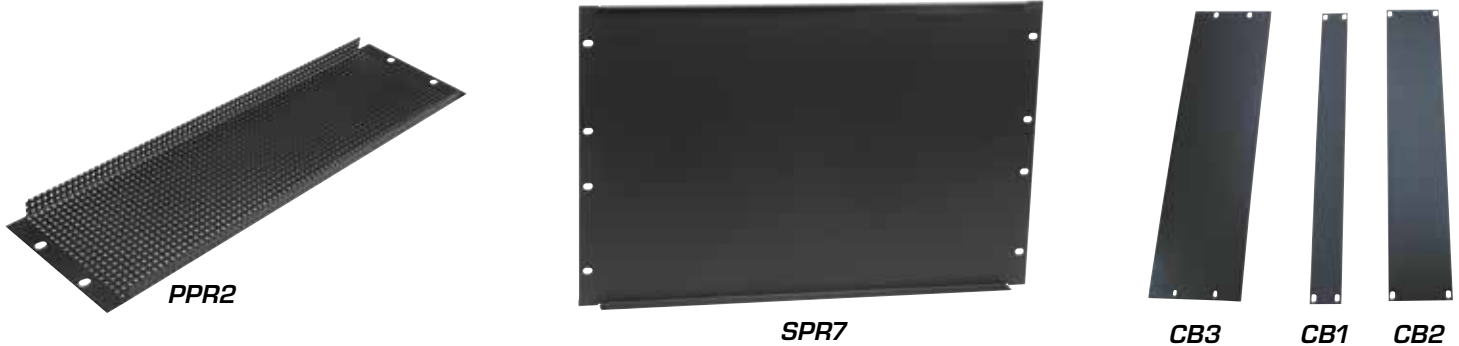

	1RU 1¾"	2RU 3½"	3RU 5¼"	4RU 7"	5RU 8¾"	6RU 10½"	7RU 12¼"	8RU 14"	12RU 21"	14RU 24½"	18RU 31½"
Solid Economy	CB1	CB2	CB3	CB4							
Solid Recessed	SPR1	SPR2	SPR3	SPR4	SPR5	SPR6	SPR7	SPR8			
Solid Flush		SPF2							TPS-25	TPS-30	TPS-36
Perforated Recessed	PPR1	PPR2	PPR3	PPR4	PPR5	PPR6	PPR7				
Perforated Flush									TPP-25	TPP-30	TPP-36
Security Panel	SEC1	SEC2	SEC3								



Atlas Rack Fan Panels

EFP Series

Flush fan panel assemblies dissipate equipment-generated heat quickly from 19" cabinets. Front / rear and top loading assemblies are available in single and dual fan models with 115 CFM (per fan) fan speed for flush and recessed mounting. Models are complete with fan(s) protected by nickel chrome plated wire grille backed with a steel wire mesh screen assembled to a 16-gauge CRS panel. Panels mount easily to all E.I.A. standard mounting rails and are stocked in standard black finish. Fans are factory-mounted for exhaust cooling and may be rotated easily, in the field, for intake cooling. A 6' line cord is included.

Specifications

Model	EFP3-1	EFP3-2
Height	3RU, 5¼" (133.4mm)	3RU, 5¼" (133.4mm)
Width	19" (482.6mm)	19" (482.6mm)
Depth	2⅞" (53.9mm)	2⅞" (53.9mm)
SPL @ 3'	56.2dB	58.2dB
Voltage	115VAC	115VAC
HZ	60Hz	60Hz
CFM	115 CFM	230 CFM
Current Draw	.13 Amps	.26 Amps
Number of Fans	1	2

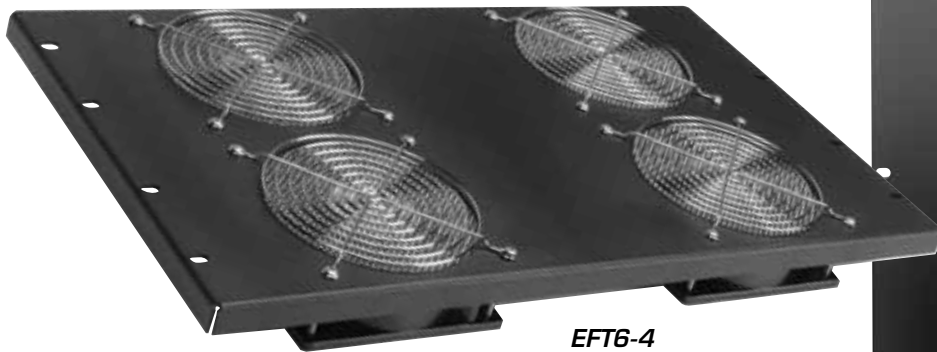
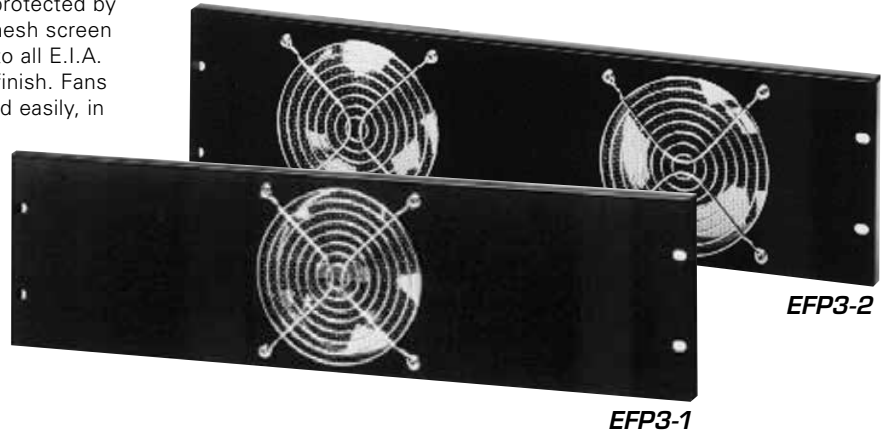

EFT Series

EFT top-mounting fan panels are powerful cooling assemblies which provide quiet and effective heat dissipation for equipment mounted in 25½" & 30" depth 700 Series & FMA Series cabinets. Space-efficient units require no vertical panel space and deliver 550 CFM with a 4" (100mm) diameter tube axial propeller fan. The EFT Series operates at 115VAC, 60Hz and includes a continuous-duty, shaded-pole type motor, sealed ball bearings, and chrome plated finger guards. Assemblies include an automatic reset thermal protector and 6' line cord with molded plug mounted to a 16-gauge CRS panel finished in standard black.

Specifications

Model	EFT-25	EFT-30	EFT-36	EFT6-4
CFM	550 CFM	550 CFM	550 CFM	460 CFM
SPL @ 3'	55dB	55dB	55dB	60.2dB
Voltage	115VAC	115VAC	115VAC	115VAC
Hz	60Hz	60Hz	60Hz	60Hz
Width	19" (483mm)	19" (483mm)	19" (483mm)	19" (483mm)
Depth	21" (533mm)	24½" (622mm)	31⅝" (799mm)	6RU, 10½" (267mm)
Projection	3½" (89mm)	3½" (89mm)	3½" (89mm)	1" (In Surface Mount Applications)

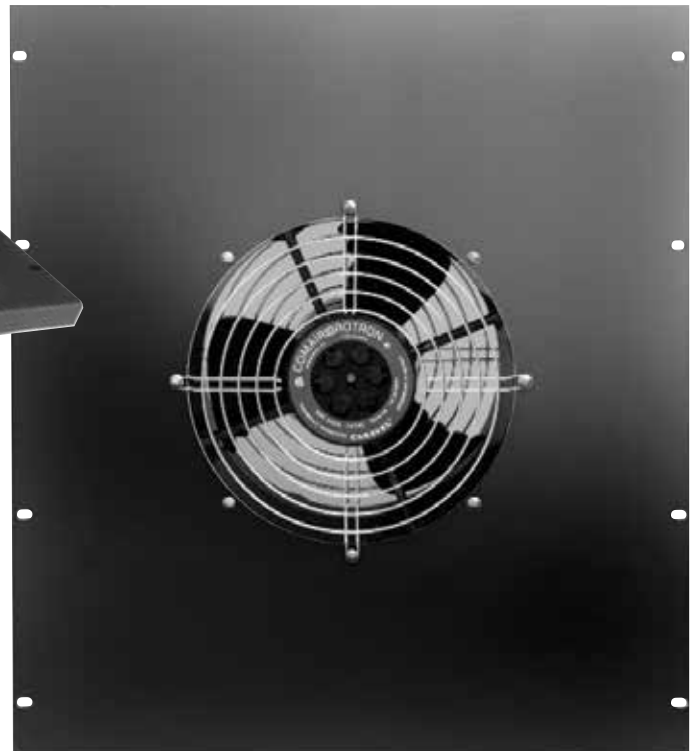

EFT-25

Roller Truck & Caster Kit Accessories

FMARTK

Heavy-duty, welded 12-gauge CRS roller truck provides mobility for FMA Series racks. Unit is designed for single-bay use and has one pair rigid and one pair locking 4" swivel casters. Recessed mounting plate does not add unneeded height to rack installations. Models available for 25", and 36" deep FMA racks. Finish is black.

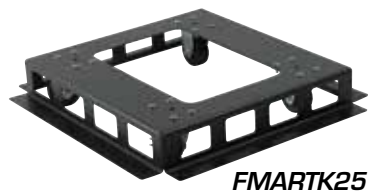

FMARTK25

RCK-700

Heavy-duty, 2 $\frac{5}{8}$ " diameter non-locking swivel casters have a load-bearing capacity of 255lbs each. Units are zinc-plated and include black, hard-tread wheels. Model accommodates 700 Series cabinets only. Sold in groups of four.



RCK-700

CT1020-962

Heavy-duty, welded 16-gauge CRS roller truck provides mobility for 19" width x 18 $\frac{1}{2}$ " depth cabinets. Unit is designed for single-bay use and has one pair rigid and one pair locking 3" swivel casters. Model accommodates 18 $\frac{1}{2}$ " depth 100 Series & 200 Series. Finish is black.



CT1020-962

RCK-18

Caster kit provides for caster installation onto 19" width x 18 $\frac{1}{2}$ " depth cabinets in single or multi-bay installations. Kit includes four, non-locking, 2 $\frac{5}{8}$ " diameter casters and two, easy-to-install, 18 $\frac{1}{2}$ " length mounting / supporting brackets. Model accommodates the 18 $\frac{1}{2}$ " depth 100 Series & 200 Series cabinets.

RCK-25

Caster kit provides for caster installation onto 19" width x 25 $\frac{1}{2}$ " depth cabinets in single or multi-bay installations. Kit includes four, non-locking, 2 $\frac{5}{8}$ " diameter casters and two, easy-to-install, 25" length mounting / supporting brackets. Model accommodates the 25 $\frac{1}{2}$ " depth 200 Series and 500 Series cabinets.

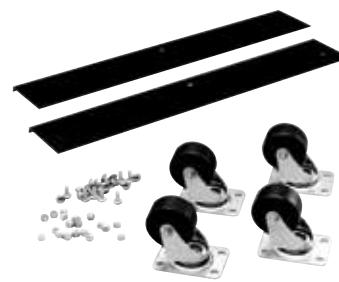

RCK-18 / RCK-25 / RCK-30

RCK-30

Caster kit provides for caster installation onto 19" width x 30" depth cabinets in single or multi-bay installations. Kit includes four, non-locking, 2 $\frac{5}{8}$ " diameter casters and two, easy-to-install, 30" length mounting / supporting brackets. Model accommodates the 30" depth 200 and 500 Series cabinets.

Specifications

Model	FMARTK25	FMARTK36	RCK-700	CT1020-962	RCK-18	RCK-25	RCK-30
Height	4" (102mm)	4" (102mm)	2 $\frac{5}{8}$ " (67mm)	4" (102mm)	3 $\frac{3}{4}$ " (95mm)	3 $\frac{3}{4}$ " (95mm)	3 $\frac{3}{4}$ " (95mm)
Locking	Yes (1 Pair)	Yes (1 Pair)	No	Yes (1 Pair)	No	No	No
Mounts	FMA35-25SA FMA35-25G FMA44-25SA FMA44-25G	FMA44-36G	735-25 740-25 744-25 744-30 744-36	121-18 124-18 135-18 140-18 144-18 221-18 224-18 235-18 240-18 244-18	121-18 124-18 135-18 140-18 144-18 221-18 224-18 235-18 240-18 244-18	221-25 224-25 235-25 240-25 244-25 535-25 540-25 544-25	221-30 224-30 235-30 240-30 244-30 544-30

Additional Rack Rails / Bus Bars

FMA-RR Series

For use with the FMA Series Racks.

Mounting rails are comprised of 12-gauge CRS and are tapped 10-32 on E.I.A. spacing $5/8"$ - $1/2"$ continuous centers and finished in black. Rails are sold in pairs and include hardware. FMA Series cabinets come with two pairs of rails. Order extra rails for additional equipment support as needed.

Specifications

Model	FMA-RR35	FMA-RR44
Height	35RU 61 $\frac{3}{8}"$ (1559mm)	44RU 77 $\frac{1}{8}"$ (1960mm)

RR Series

For use with 200, 500, 700, & RX Series Racks.

Mounting rails are comprised of 11-gauge CRS and are tapped 10-32 on E.I.A. spacing $5/8"$ - $1/2"$ continuous centers and finished in black. Rails are sold in pairs and include hardware. All cabinets come with front rails. Order extra rails to provide additional equipment support.

Specifications

Model	RR14	RR21	RR24	RR35	RR40	RR44
Height	14RU 25 $\frac{5}{8}"$ (626mm)	21RU 36 $\frac{3}{8}"$ (934mm)	24RU 42 $\frac{1}{8}"$ (1070mm)	35RU 61 $\frac{3}{8}"$ (1559mm)	40RU 70 $\frac{1}{8}"$ (1781mm)	44RU 77 $\frac{1}{8}"$ (1960mm)

RR3 Series

For use with the 300 Series Racks.

Mounting rails are comprised of 11-gauge CRS and are tapped 10-32 on E.I.A. spacing $5/8"$ - $1/2"$ continuous centers and finished in black. Rails are sold in pairs and include hardware. All cabinets come with front rails. Order extra rails to provide additional equipment support.

Specifications

Model	RR310	RR312	RR316	RR324	RR335
Height	10RU 17.5" (445mm)	12RU 21" (533mm)	16RU 28" (711mm)	24RU 42" (1070mm)	35RU 61 $\frac{1}{4}"$ (1556mm)

Copper Bus Bar

BBG Series

Functional copper strips are available in six lengths to provide a convenient method of grounding for rack mounted equipment. Bars mount easily to cabinet structure with $1/4"$ -20 hardware (provided). Each bar is $1/4"$ Deep x $3/4"$ wide.

Specifications

Model	BBG13	BBG21	BBG24	BBG35	BBG40	BBG44
Material	Copper	Copper	Copper	Copper	Copper	Copper
Height	13RU 22 $\frac{3}{4}"$ (578mm)	21RU 36 $\frac{3}{4}"$ (933mm)	24RU 42" (1067mm)	35RU 61 $\frac{1}{4}"$ (1556mm)	40RU 70" (1778mm)	44RU 77" (1956mm)
Weight	1.75lbs (.8kg)	2.75lbs (1.25kg)	3.25lbs (1.5kg)	4.5lbs (2kg)	5.25lbs (2.4kg)	5.75lbs (2.6kg)

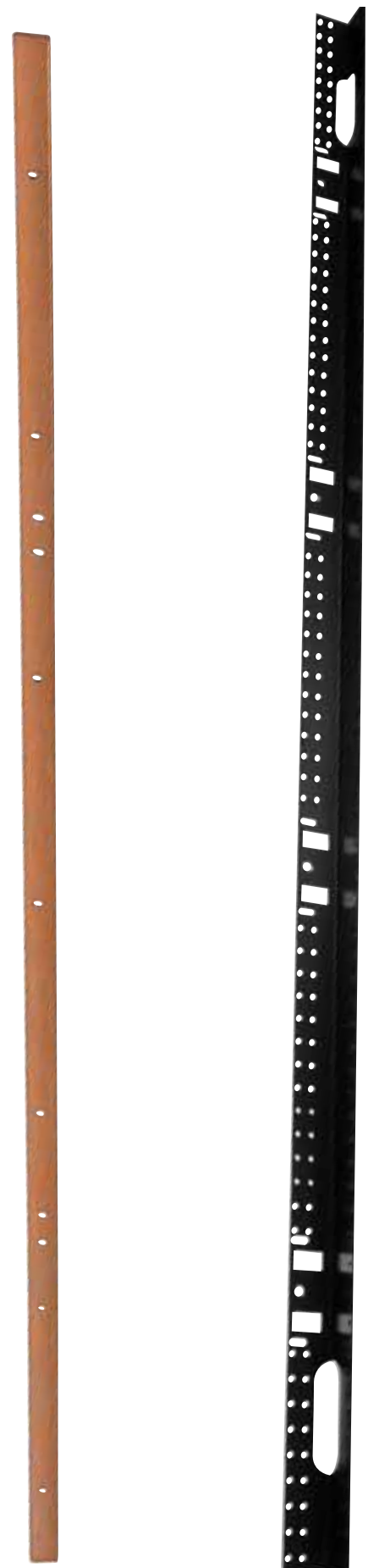

BBG

FMA-RR44

Atlas Rack Drawers / Storage

SD Series - Recessed Storage Drawers

Perfect for storage of discs, microphones, tools, and accessory items in fixed or portable racks. 16-gauge CRS drawers mount into 19" cabinets and ship complete with high impact plastic pull handles and steel ball bearing rollers. Drawer hanger assembly is inverted to prevent contents from spilling if cabinet is tilted. Slots are included in the hanger assembly to allow use of SH Series rear support brackets for additional stability in mobile applications. Optional SD-LOCK may be installed for additional security (discrete hole plug fills cut-out if lock is not required). Overall drawer depth is 14 $\frac{7}{16}$ ". Models available in 2, 3, 4, & 6RU heights.



SD2-14

Specifications

Model	SD2-14	SD3-14	SD4-14	SD6-14
Height	2RU, 3 $\frac{1}{2}$ " (89mm)	3RU, 5 $\frac{1}{4}$ " (183mm)	4RU, 7" (178mm)	6RU, 10 $\frac{1}{2}$ " (267mm)
Inner Width	16 $\frac{5}{16}$ " (414mm)	16 $\frac{5}{16}$ " (414mm)	16 $\frac{5}{16}$ " (414mm)	16 $\frac{5}{16}$ " (414mm)
Depth	14 $\frac{7}{16}$ " (366mm)	14 $\frac{7}{16}$ " (366mm)	14 $\frac{7}{16}$ " (366mm)	14 $\frac{7}{16}$ " (366mm)
Color	Ebony Black	Ebony Black	Ebony Black	Ebony Black



CD4



CD4 - Media Storage Shelves

Convenient CD media storage shelf features slot dividers for increased strength. Construction is of 16-gauge cold rolled steel finished in black textured electrostatic powder coat (-052). Unit holds 40 standard CD jewel cases.

Specifications

Height	3RU, 5 $\frac{1}{2}$ " (140mm)
Width	19" (483mm)
Depth	5 $\frac{5}{16}$ " (135mm)
Color	Ebony Black
Holds	40 Standard Jewel Case CD Cases



PCD3-16-052

PCD3-16-052 - Pencil Drawer

Dual-function sliding pencil drawer features a handy storage area covered by a lift-up writing surface. Unit is constructed of 18-gauge CRS and mounts in most 19" racks or cabinets. Hinged writing surface is 16 $\frac{5}{16}$ " wide particle board covered with wood grain laminate. Drawer slides include hold-in detents and 100lbs (45kg) rated steel ball bearings for smooth extension and easy content accessibility.

Specifications

Height	2RU, 3 $\frac{1}{2}$ " (89mm)
Drawer Width	16 $\frac{5}{16}$ " (414mm)
Depth	16 $\frac{7}{16}$ " (417mm)
Color	Ebony Black

Atlas Rack Shelves

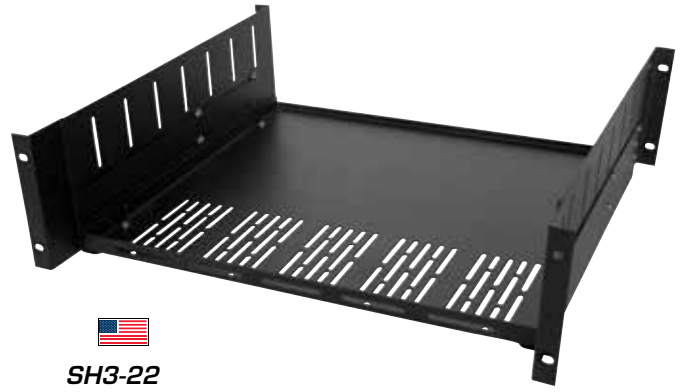
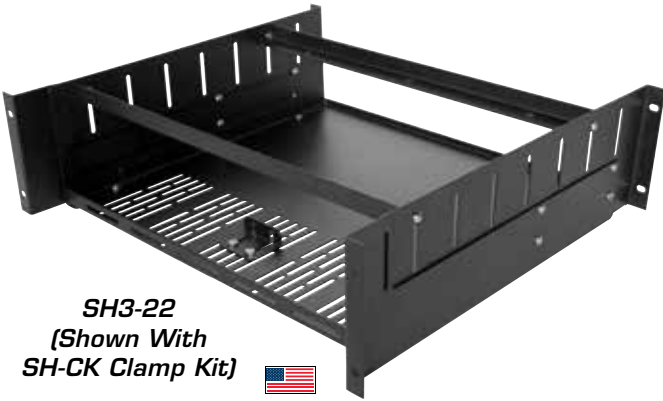

SH Series - Clamping Shelves

Clamping rack shelf systems are designed specifically to secure equipment that is not easily rack mounted, such as VCRs and "prosumer" A/V surround sound receivers into any Atlas Sound wall mount cabinet or vertical rack. SH Series shelves offer a sturdy, side, rear, and top support to ensure that once the equipment is placed on the shelf, it's locked in for the duration. Three Shelves In One – Modular design allows you to choose the right shelf system for each job. The formed construction 16-gauge shelves are offered in three EIA compliant heights (2 RU, 3 RU, and 4 RU), 15" or 22" depths, and come equipped with slots on the sides and bottom for optimum ventilation. For applications where "clamping" brackets are required, specify model SH-CK. The rubber-lined clamps securely hold components from the top. Adjustable "L" brackets are included to provide a secure fit and a component "stop" from the rear. For applications where rear rack rail support is necessary (with or without clamping requirements), add model SHRSB bracket kit.

Specifications

Model	SH2-15	SH3-15	SH4-15	SH2-22	SH3-22	SH4-22
Height	2RU 3½" (89mm)	3RU 5¼" (133mm)	4RU 7" (178mm)	2RU 3½" (89mm)	3RU 5¼" (133mm)	4RU 7" (178mm)
Depth	15" (381mm)	15" (381mm)	15" (381mm)	22" (559mm)	22" (559mm)	22" (559mm)
Width	19" (483mm)	19" (483mm)	19" (483mm)	19" (483mm)	19" (483mm)	19" (483mm)

SH Series Accessories

- SHRSB2 2RU Rear Rack Rail Support Bracket for all 2RU Models.
- SHRSB3 3RU Rear Rack Rail Support Bracket for all 3RU Models.
- SHRSB4 4RU Rear Rack Rail Support Bracket for all 4RU Models.
- SH-CK Optional Equipment Clamping Kit. Fits all SH Series Models.



Vented One-Piece All-Purpose Shelf

Versatile formed shelving is 16-gauge CRS and includes mounting holes on E.I.A. standard spacing. Finished in black textured finish. Unit is secured using a single pair of front mounting rails. No assembly is required.

Sliding Shelf / Tray for Cabinets with Front & Rear Rails

Versatile shelf provides easy access to keyboards and control equipment. Solid bearing slides extend to a full 17" (432mm) outside of cabinet rails with lock-out protection. Dual-purpose design may be used right-side up as a shelf or upside-down as a tray with a protective lip according to desired application. Model mounts 19" cabinets (18½" to 25½" deep) equipped with front and rear mounting rails. Load bearing capacity is 85lbs (38.5kg). Constructed of 16-gauge CRS and finished in standard black.

Specifications

Model	SH1-10
Height	1RU, 1¾" (44mm)
Width	19" (483mm)
Depth	10" (254mm)
Color	Ebony Black

Specifications

Model	VTD1-16
Height	1RU, 1¾" (44mm)
Width	16¾" (426mm)

Universal Monitor Rack Mount



ASUMRM9
(Monitor Not Included)

Universal Monitor Rack Mount Kit

The ASUMRM9 is designed for mounting flat panel displays in Atlas Racks. This 9RU kit is perfect for providing visual feedback for Atlas Sound's ControlKom and Varizone mass communication systems or other video surveillance systems in need of visual monitoring at the rack. It accommodates any 4:3 display up to 19" diagonally in length, and features a black powder coat finish to match the look of the racks themselves.

Specifications

Height	9RU, 15¾" (400mm)
Depth	4" (102mm)
Shipping Weight	7.5 lbs
Color	Black



Wall Mount Shelving

Wall-Mount Shelf / Enclosure System

WME150. Extremely versatile six-piece Wall-Mount Shelf / Enclosure System unit is easy to assemble in a variety of configurations (in utility closets and anywhere space is at a premium). The six piece set is shipped flat and can be assembled with common tools. In the two shelf configuration with the supporting side panels, the wall-mount shelf can be used for a wide variety of equipment with a locking door or top. It can be configured as a locking enclosure with two shelves or as a two-shelf-open enclosure. Construction is 16-gauge CRS and finished in Neutral White (-592).

AS-120 / AS-140. Sturdy shelves with wire access provide for convenient wall-mounting of amplifiers or electronic equipment. AS-120 includes keyhole mounting slots. Versatile AS-140 may be mounted so equipment is installed between side supports or inverted "bookshelf-style" for open equipment placement. Construction is 16-gauge CRS. Finished in Neutral White (-592).

Specifications

Model	WME150	AS-120-592	AS-140-592
Height	16½" (419mm)	10" (254mm)	12¾" (314mm)
Width	21" (533mm)	20" (508mm)	20" (508mm)
Depth	16½" (419mm)	12½" (318mm)	17" (432mm)
Color	Neutral White	Neutral White	Neutral White
Weight Capacity	150lbs	100lbs	150lbs

Wall Mount System

The AWW Series is a cost effective wall mount system which allows low profile mounting of Ethernet switches, mixer amplifiers or other rack mount electronics. These bracket style hardware kits are offered in 2, 3, & 4RU configurations and create flush mounting options for equipment – vertically to walls or under desks and work spaces- when space and component needs do not facilitate the need for a full rack.

Specifications

Model	AWV2	AWV3	AWV4
Depth	2RU	3RU	4RU
Touch-Up Paint	(4.5 oz Spray)		
SP962	Midnight Black		
SP052	Ebony Black		

Rack Screws / Accessories

RSCW100	100 Piece Rack 10-32 x ¾" Screw Bag w/ Captive Plastic Washer
RSCW500	500 Piece Rack 10-32 x ¾" Screw Bag w/ Captive Plastic Washer
HK-40	40 Chrome Rack 10-32 x 1" Screw Bag with Captive Washer
HK-40CN	40 Piece Clip on Cage Nuts



WME150-592

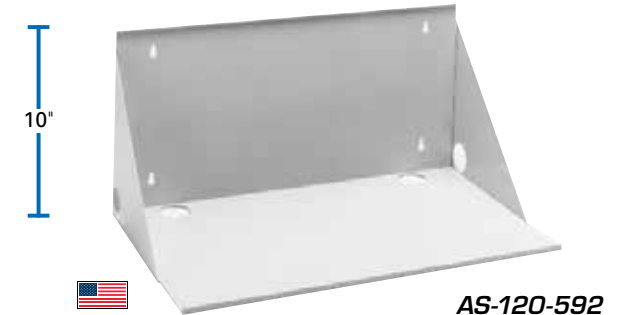

AS-120-592

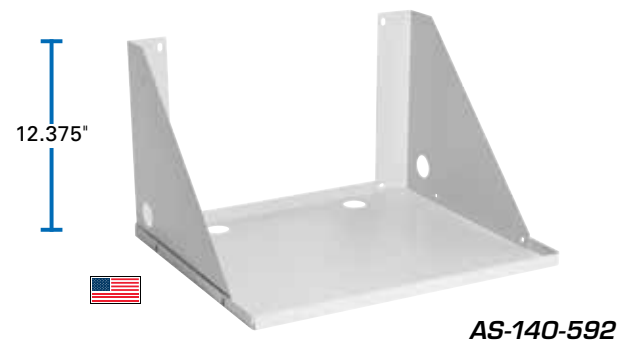

AS-140-592



AWV4



Rack Screws / Accessories

MVXA-2016



MVXA-2016



MVXA-2016 (Back)

Multi-Channel Amplified Monitor Panel

Atlas Sound MVXA monitor panel is an active device for aural and visual monitoring, for sixteen different speaker and line level circuits in any combination. Each input is individually selectable using an easy-to-position jumper. The MVXA-2016 offers superior performance with easy visual assessment in an ultra-thin single rack space chassis. Twelve segment LED bar-graphs provide 33dB of resolution and monitor any combination of line level (1V reference) —25V RMS, 70.7V RMS, and 100V RMS simultaneously. The bottom ten LEDs are green and have a VU ballistics response. The two red LEDs at the top of the bar graph are peak to provide instantaneous level indication. LED meter sensitivity is -30dB to +30 dB. The MVXA-2016 offers the capability to aurally monitor individual channels via an internal speaker, headphone jack, line level output to external amplifier or 3 watt high-fidelity output to an external speaker. Panel functions include a channel selection knob, channel audible monitoring level control and headphone jacks. External power supply is UL Listed. Unit weight is 7lbs (3.2kg).

Specifications

Height	1RU, 1¾" (34mm)
Depth	13½" (335mm)
Width	19" (482mm)
Supply Voltage	15 VAC Power Supply (included)
Channels	16 channels
Total Harmonic Dist.	< 1%
Floor Noise	76dB
Internal Speaker Output	3 Watts / 8Ω
Power Consumption	6 Watts
Frequency Response	35Hz - 20kHz
Channel Turn-On Delay	1 Second
Inputs Avail. "0dB" Ref:	Line Level (1V), 25V, 70.7V, 100V
Audio Outputs	3 Watt Amplifier (5 Watt Peak) Into: Internal Speaker, Headphone Jack, External Speaker Output (4Ω or 8Ω), and Line Level Output.
LED Display Accuracy	1.5dB
LED Display Sensitivity	-30dB to +3dB
LED Display Monitoring Range	0.0316 VRMS (-30dBV) to 141 VRMS
LED Display Dynamics	Bottom 10: Green, VU Response (-30dB – -2dB) Top 2: Red, Peak Response (0dB – +3dB)

MVX-193



MVX-193

Monitor Panel

Designed for economical multi-channel system applications that require quality aural and visual monitoring. Models are available with choice of loudspeaker and VU meter for 25V or 70.7V systems. To enable monitoring of up to five program channels, all units include a 6-position, double-pole switch with a positive "Off" position and a volume control for adjusting the level of the monitor loudspeaker. Each monitored circuit connects to two rear-mounted screw terminals. Front panels are 16-gauge CRS, finished in black. Potentiometers and channel selectors are rear mounted with white nomenclature. VU meters are of moving coil design and include type "A" meter scale and protective thermoplastic cover.

Specifications

Height	2RU, 3½" (89mm)
Depth	4" (102mm)
Width	19" (483mm)
Channels	5 Channels
Loudspeaker Diameter	3" (76mm)
VU Meter	Yes
Meter Adjust	Yes

MMK Series

MMK Series Rack Mount Monitors

- Meets EIA310c and IEC-3 Specifications
- Built in Keyboard, Touch Pad and Monitor
- Heavy Duty Steel Construction
- Anti-Glare Tempered Glass for Added Protection for the LCD Screen
- Built-In Side Railing for Easy Installation
- Built-In Rail Self Locking Device
- 105 Character US Keyboard
- Power Supply: 100VAC / 240VAC Auto Switch

With rack space becoming more and more precious, network administrators are always looking for solutions that will save them any additional RUs. The MMK Series are a 1RU drawer design with an integrated LCD monitor, keyboard, and mouse. Features include flip-up design, adjustable brackets and built in LCD OSD to provide effective assistance for network administrators controlling single or multiple PCs.



MMK17-RM

Specifications

Model	MMK15-RM	MMK17-RM
Display Size	15" (381mm)	17" (432mm)
Panel Type	Active Matrix TFT LCD	Active Matrix TFT LCD
Max Resolution	1024 x 768 (XGA)	1280 x 1024 (SXGA)
System Cables	VGA + PS/2 (x2), VGA + USB (x1)	VGA + PS/2 (x2), VGA + USB (x1)
Power Consumption	16 Watts, 10.41W for Panel	25 Watts, 19.05W for Panel
Net Weight	26.46 lbs (12Kg)	28.7 lbs (13.0Kg)
Gross Weight	43.0 lbs (19.5Kg)	45.2 lbs (20.5Kg)
Keyboard / Mouse	106 key PS/2 Keyboard with Touch Pad	106 key PS/2 Keyboard with Touch Pad
Power Source	100VAC ~ 240VAC Input	100VAC ~ 240VAC Input
Multi Platform Support	PS/2 and USB	PS/2 and USB
Height	1.7" (44mm)	1.7" (44mm)
Width	18.5" (470.1mm)	18.5" (470.1mm)
Depth	17.6" (447.5mm)	17.6" (447.5mm)
Temperature	Operate: 32°F ~ 122°F (0°C ~ 50°C)	Operate: 32°F ~ 122°F (0°C ~ 50°C)
Certification	CE / FCC, UL / CUL / C-Tick, GOST	CE / FCC, UL / CUL / C-Tick, GOST

MMK Series

MMK Series Rack Mount Monitor / Keyboard Accessories

The mmK15-RM and mmK17-RM consoles connect to attached servers and computers through the mmK-KVM8 8-port modular combo-free KVM switch. It has complete keyboard and mouse emulation for simultaneous PC boot up process and supports MS Windows, Netware, Unix, and Linux systems or iMac, Power Mac and Sun Micro Systems via USB port. No software is required and the KVM switch features On Screen Display (OSD) menu, password security, hot key control, and auto scan control.

The mmK-KVM8 also includes one optional IP-based remote console port for use with the mmK-IPM IP interface module to control one or several computers locally at the server site or remotely via the Internet using a standard browser. The mmK-IPM switch redirects local keyboard, mouse and video data to a remote administration console to securely gain BIOS level access to systems for maintenance, support, or failure recovery online. Communication is encrypted with SSL for added security.

Connection is made from the mmK-KVM8 to servers and computers with the mmK-DB10 cable. The mmK-DB10 cable connects via VGA monitor port and single USB connector for both keyboard and mouse data as a standard HID (Human Interface Device) with no extra driver needed. The mmK-DB10 is 3m in length.

MMK Series Rack Accessories

MMK-KVM8	8-port Modular Combo-Free KVM Switch
MMK-IPM	IP Interface Module Switch
MMK-DB10	3 Meter HDDB-15 to VGA + USB Cable



LAR150

The Load-A-Rack 150 (LAR150) is a patent pending installation tool developed by the Atlas Sound engineering team and designed to facilitate the loading and unloading of electronic components and accessories into EIA Standard equipment racks. The LAR150 works with any full rack width equipment and easily latches to the front rails of the rack being loaded, providing perfect horizontal and screw hole alignment. The LAR150 can support gear weighing up to 150 pounds, including multiple amplifiers stacked on top of each other. The LAR150 is another example of the innovative thinking at Atlas Sound.



Miscellaneous

Leg Levelers

LL2

Heavy-duty leg levelers provide stabilization on uneven surfaces for FMA, 700, & 500 Series cabinets. 4-piece sets are steel construction with heavy duty rubber cushion with chrome cap and adjust with standard wrenches.

Specifications

Finish	Chrome
Mounts	FMA, 700, & 500 Series

Horizontal & Vertical Lacing Bars

LR4

Trapezoidal steel lacing bars with 4" offset provide clean lacing in close proximity to rack mount equipment I/O. Sold in a 10 piece bag.

LRS

Steel lacing bars are a handy 19" EIA horizontal accessory perfect for assisting rack fabricators in executing clean wiring runs inside Atlas Sound racks & cabinets. Sold in a 10 piece bag.

VLS44

Vertical lace bar provides a vertical lace path inside the rack to assure clean wire management. 44RU (77") unit may be cut for use in shorter Atlas Sound racks. Mounting points are provided for attachment to internal rack hat sections. Unit is 2" wide x 1⁵/₁₆" thick (50.8mm x 24mm).

Specifications

Model	LR4	LRS	VLS44
Color	Black	Black	Black
Sold As	10 Piece	10 Piece	1 Piece

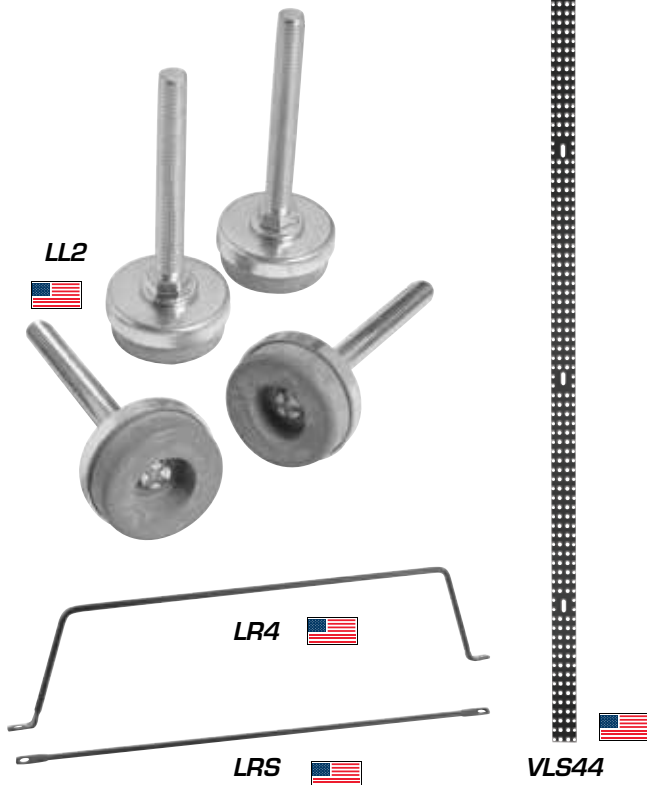

Rack Work Light



RWL2

Portable lamp with wide light diffusion provides illumination of interior rack spaces. Supplied with a "non-mar" magnetic mount, 3-wire grounded AC outlet, On/Off switch, high impact clear polycarbonate lens, two 10 watt incandescent lamps (one for replacement) and 6' power cord. Assembly is 18 and 22-gauge CRS. Standard finish is flat black epoxy with galvanized head.

Specifications

Voltage	115VAC
Cord Length	6'
Light Bulb	10 Watts
Mount	Non-Mar Magnetic Mount

Fan Thermostat

CFT-125

Unit provides ventilation control of fans and other cooling equipment. Thermostat includes an automatic shut-off feature and a special 3-wire extension cord with series plug for automatic operation. Use the thermostat knob to make temperature adjustments at dial settings from 40°F to 90°F. The CFT-125 is UL and CSA-listed.

Specifications

Height	5½" (140mm)
Width	1½" (38mm)
Depth	2½" (64mm)
UL Listed	UL873





Protecting rack mounted, critical electronics is vital to the success of any installation. Atlas Sound power conditioners and distribution units are an easy to install platform that offer several layers of protection from not only electrical surges but also other forms of interference that can degrade the performance of audio amplifiers, processors, servers, and video production units.

Atlas Power Rack Mount Power Conditioner and Distribution Units

Applications

The Atlas Power AP horizontal rack mount power conditioner and distribution units are designed for use in a variety of rack mount applications. AP horizontal rack mount units are available in both 15A and 20A configurations. Each unit features both switched and un-switched outlets providing installation flexibility. These models can be used anywhere that electrical protection of critical electronics is required including restaurants, houses of worship, schools, home theaters, and office buildings.

Features

- Radio Frequency Interference Filter
- Electromagnetic Interference Filter
- Front & Rear Panel Outlets
- Circuit Breaker Protection
- Electrical Surge Protection
- 1RU Height

General Description

Atlas Sound AP horizontal rack mount power conditioner and distribution units have been designed to meet most installation requirements for AC power distribution and equipment power protection. Each model features noise filtering for unwanted Radio Frequency Interference (RFI) that is commonly introduced into the AC lines by nearby radio transmitters or wireless products. Electromagnetic Interference (EMI) filters are incorporated to reduce noise from items including electric motors, switching power supplies and lightning. The result of this filtration is evident on video products or audibly by reducing static pops and external signal interference.

Unstable AC Mains voltage is one of the main reasons for equipment failure. AC Spikes, or Transients, are commonly caused by lightning storms or utility power plant grid switchovers. The amount of energy that can be injected into the power system can be immense with voltages reaching 6KV or current peaks of 3000A. These spikes are very fast and usually only last for a very short period of time. To protect against this potential problem, all AP power conditioner and distribution units feature suppression technology that protects against line to neutral, line to ground, and neutral to ground protection. If a spike intrudes the AC system, the circuitry can suppress unwanted energy within a nanosecond, while sustaining the suppression up to 2 milliseconds, thus ensuring virtually trouble free protection.

Models are available with either 15A or 20A circuit breaker protection allowing for use in multiple installation scenarios for a variety of rack mounted equipment protection. Each unit features both front and rear panel outlets with a variety of switched and un-switched outlet configurations. All models use a 1RU chassis that is rack mountable in a standard 19" width rack. All models are also safety listed.

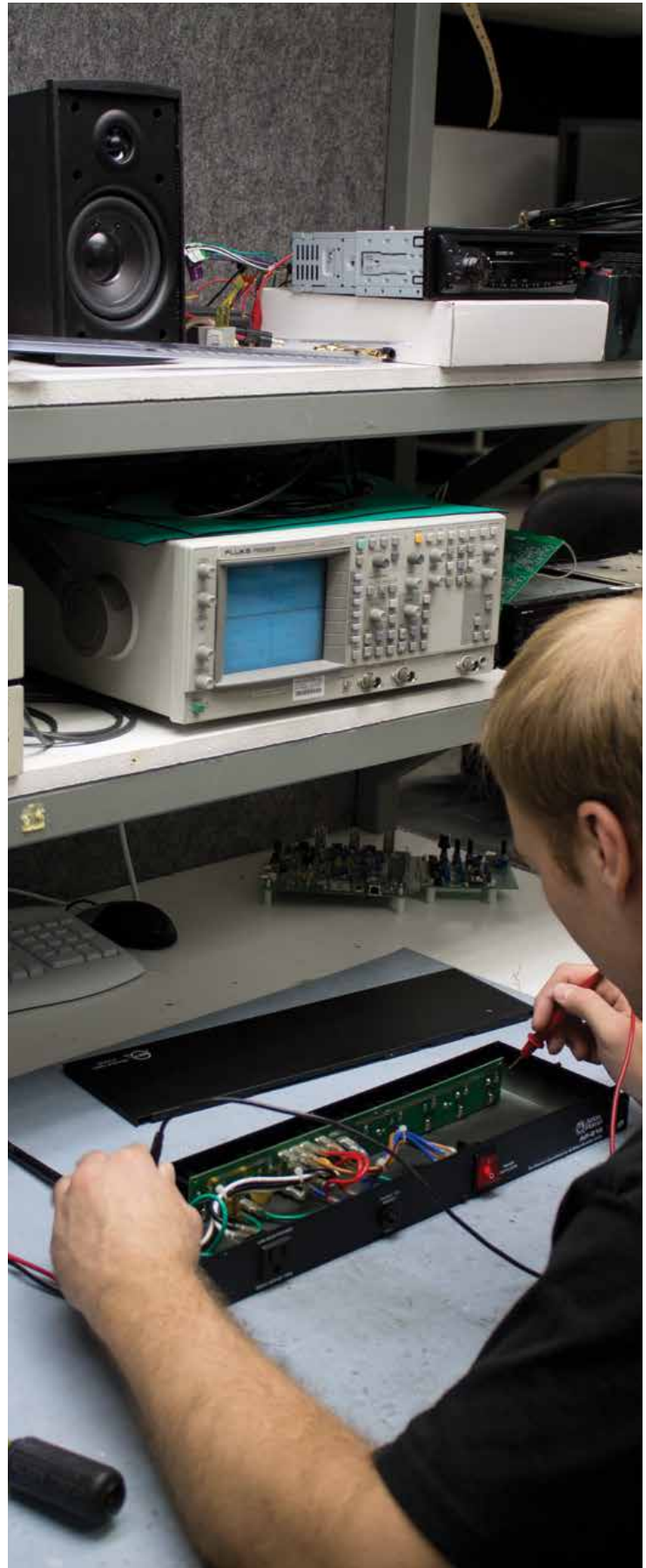

**Electrical Engineer Bench Testing
AP-S15 Power Conditioner**



AP-C15D

Features

- Outlet Spacing That Accepts Most Power Supply Sizes
- 10 Total Outlets Are Provided
 - 8 Rear Panel Outlets
 - 2 Front Panel and 1 Rear Panel Unswitched Convenience Outlets
- Radio Frequency Interference (RFI) Noise Filtering
- Electromagnetic Interference (EMI) Filtering
- Dual Clamping Spike & Surge Suppression, DCS Circuitry
- Front Panel Digital AC Mains Voltmeter
- LED Indication of Reversed "Live" and "Neutral" Wiring
- Abnormal AC Line Voltage Indicator for Voltages Between 101V–107V or 128V–132V
- Extreme Voltage Shutdown (EVS) Below 101V or Above 132V AC Line
- Circuit Breaker Protection @ 15A Indicated by "Breaker Open" Indicator
- Front Mounted Pull-out LED Light With 2-Position Dimmer
- Rear Mounted XLR Connector for 12VDC LED Lamp (Part Number AP-GNL18 Sold Separately)

Specifications

Outlets	NEMA 5-15R Quantity 10
Current Rating	15 Amps
Operating Voltage	102-132VAC
Minimum Spike Clamping Voltage	460VRMS @ 3000A
Maximum Spike Clamping Voltage	6000V
Power Consumption	12 Watts
Height	1¾" (44.5mm)
Width	19" (482.6mm)
Depth	8½" (219.5mm)
Safety Listing	UL1449



AP-C15D



AP-C15D Back



Atlas Power Solutions Are Easily Integrated Into Any Standard Equipment Rack

AP-S15L

Features

- 9 Total Outlets
 - 8 Rear Panel Switched Outlets
 - 1 Front Panel Unswitched Outlet
- Radio Frequency Interference (RFI) Noise Filtering
- Electromagnetic Interference (EMI) Filtering
- AC Fault Indicator
- Circuit Breaker Protection @ 15A
- Spike Suppression Up to 6000V
- Front Mounted Pull Out LED Lamp
- Rear Mounted XLR Connector for 12VDC LED Lamp (Part Number AP-GNL18 Sold Separately)

Specifications

Outlets	NEMA 5-15R Quantity 9
Current Rating	15 Amps
Operating Voltage	102-132VAC
Minimum Spike Clamping Voltage	460VRMS @ 3000A
Maximum Spike Clamping Voltage	6000V
Power Consumption	8 Watts
Height	1¾" (44.5mm)
Width	19" (482.6mm)
Depth	8½" (219.5mm)
Safety Listing	UL1449



AP-S15L



AP-S15L Back

AP-S15

Features

- 9 Total Outlets
 - 6 Rear Panel Switched Outlets
 - 2 Rear Panel Unswitched Outlets
 - 1 Front Panel Unswitched Outlet
- Radio Frequency Interference (RFI) Noise Filtering
- Electromagnetic Interference (EMI) Filtering
- Circuit Breaker Protection @ 15A
- Spike Suppression Up to 6000V

Specifications

Outlets	NEMA 5-15R Quantity 9
Current Rating	15 Amps
Operating Voltage	102-132VAC
Minimum Spike Clamping Voltage	460VRMS @ 3000A
Maximum Spike Clamping Voltage	6000V
Power Consumption	8 Watts
Height	1¾" (44.5mm)
Width	19" (482.6mm)
Depth	8½" (219.5mm)
Safety Listing	UL1449

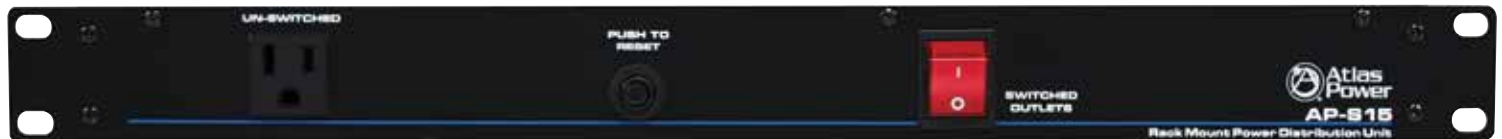

AP-S15



AP-S15 Back

AP-S20

Features

- 9 Total Outlets
 - 7 Rear Panel Switched Outlets
 - 1 Rear Panel Unswitched Outlet
 - 1 Front Panel Unswitched Outlet
- Radio Frequency Interference (RFI) Noise Filtering
- Circuit Breaker Protection @ 20A
- Spike Suppression Up to 6000V
- AC Protect Active Indicator

Specifications

Outlets	NEMA 5-20R Quantity 9
Current Rating	20 Amps
Operating Voltage	102-132VAC
Minimum Spike Clamping Voltage	460VRMS @ 3000A
Maximum Spike Clamping Voltage	6000V
Power Consumption	.8 Watts
Height	1¾" (44.5mm)
Width	19" (482.6mm)
Depth	8½" (219.5mm)
Safety Listing	UL1449

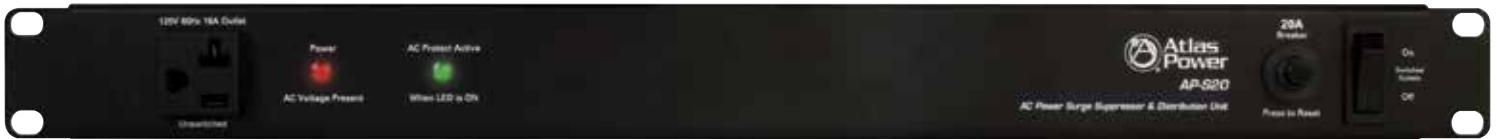

AP-S20



AP-S20 Back

AP-S20RT

Features

- 9 Total Outlets
 - 6 Rear Panel Switched Outlets
 - 2 Rear Panel Unswitched Outlets
 - 1 Front Panel Unswitched Outlet
- Remote Activation via Latched Dry Contact Closure or DC Voltage
- Remote Status LED Power Terminals
- Rear Mounted Remote Activation Bypass Switch
- Emergency Power Down to Incorporate with Fire Control Panels
- Extreme Voltage Shutdown Clamping Spike & Surge Suppression Circuitry
- Radio Frequency and Electromagnetic Interference Filters
- Front Mounted USB Charger / Light Port and Rear Mounted XLR Connector for 12VDC LED Lamp (Part Number AP-GNL18 Sold Separately)

Specifications

Outlets	NEMA 5-20R Quantity 9
Current Rating	20 Amps
Operating Voltage	102-132VAC
Minimum Spike Clamping Voltage	460VRMS @ 3000A
Maximum Spike Clamping Voltage	6000V
Power Consumption	8 Watts
Height	1¾" (44.5mm)
Width	19" (482.6mm)
Depth	8" (203mm)
Safety Listing	UL60065



AP-S20RT



AP-S20RT Back



There are many key electrical components that are frequently used in commercial applications that require high amounts of current, especially during start-up. Atlas Sound sequencing units provide different options for connecting these units to a distributed power source while at the same time offering variable sequential timing allowing for units to be powered On and Off based on connected equipment need.



ECM-2063 Variable Load Circuitry Test in Phoenix Engineering Facility

Atlas Power Rack Mount Power Sequencing Units

Applications

The Atlas Power sequencing units are designed for use in a variety of rack mount applications. These models can be used anywhere that electrical sequencing of critical electronics is required including restaurants, houses of worship, schools, industrial facilities, and office buildings.

Features

- Multiple Sequencing Timing Sections
- Front Panel Digital AC Mains Voltmeter
- Abnormal AC Line Voltage Indicator
- Extreme Voltage Shutdown (EVS) Technology
- External Switch Sequence Trigger Activation
- External DCV Sequence Trigger Activation 5-24VDC
- 1RU Height

General Description

Atlas Sound power sequencing units have been designed to meet most installation requirements for AC power sequencing. Each unit features multiple sequential timing sections. Sequencing can be activated via a button on the front panel or a rear mounted contact closure, additionally sequencing can be activated remotely via a 5-24VDC trigger feed located on a remote switch. Several wall plate remote switches are available and can be placed up to 1000ft away from the sequencer.

The ECS-6RM[®] can monitor up to six independent 15 / 20A AC main lines, both voltage and current readings can be viewed via the laboratory grade meters on the front panel. The ECS-6RM[®] has built in intelligence that monitors the AC lines and will inform you of potentially damaging voltages. The ECS-6RM[®] is designed to be used with Atlas Power Electrical Control Modules, ECM modules, which been designed to meet a variety of AC power management requirements. The mating of the ECS-6RM[®] to the ECM modules is accomplished using any 5 conductor cable and can be placed up to 1000ft away. Each ECM module has an input DC voltage trigger of 5VDC, plus three low voltage data port connections for AC Mains monitoring. The ECS-6RM[®] utilizes Extreme Voltage Shutdown technology to turn Off all connected modules if a voltage swing occurs above 128VAC or below 101VAC. The system must be manually reset before the unit will power on to protect all equipment connected to the unit.

The TSD-SEQ6 is part of the Atlas Sound line of Time Saving Devices. This unit incorporates the sequencing capabilities of the ECS-6RM[®] into a small and compact package. This unit can connect to up to 6 ECM modules and offers the same 6 sequenced outputs found on the ECS-6RM[®]. The mating of the TSD-SEQ6 to the ECM modules is accomplished using any 5 conductor cable and can be placed up to 1000ft away. Each ECM module has an input DC voltage trigger of 5VDC, plus three low voltage data port connections for AC Mains monitoring via front panel LED indicators.

The ECS-3 features three sequential timing sections of standard 110V outlets for connection of critical electronics including amplifiers, mixers, servers, or other rack mounted electronic device. Additionally the unit features a 24VDC output that can be used to trigger other, higher power devices like the ECM-20SH 20A standalone AC power module. The ECS-3 features noise filtering for unwanted Radio Frequency Interference (RFI) that is commonly introduced into the AC lines by nearby radio transmitters or wireless products. Electromagnetic Interference (EMI) filters are incorporated to reduce noise from items including electric motors, switching power supplies and lightning. Dual Clamping Suppression (DCS) technology is included on each sequenced output and is designed to protect connected components from AC spikes. The ECS-3 also incorporates Extreme Voltage Shutdown technology to turn Off all connected modules if a voltage swing occurs above 128VAC or below 101VAC. The system must be manually reset before the unit will power on to protect all equipment connected to the unit.



ECS-6RM^B

Features

- 6 Sequencer Timing Sections, 1, 3, or 6 Second Intervals
- 6 Independent ECM Connections
- 6 Independent Relay Closures
- Front Panel Digital AC Mains Voltage and Current Meter
- External Switch Sequence Trigger Activation
- External DCV Sequence Trigger Activation 5-24VDC
- Front & Rear Mounted XLR Connector for 12VDC Gooseneck LED Lamp (AP-GNL18 Included)
- Abnormal AC Line Voltage Indicator for Voltages Between 102V-107V or 128V-132V
- Extreme Voltage Shutdown (EVS) Below 102V or Above 132V AC Line
- EPD Emergency Power Down

Specifications

Sequencer Sections	6
Relay Sections	6
Sequence Timing	Unit Settings of 1, 3, or 6 Seconds
Power Supply	External Wide Range 100V-240VAC, UL Approval
Power Consumption	.8 Watts
RoHS Compliant	Yes
Lights	XLR Socket to Provide 12VDC for 16" Gooseneck Lamp AP-GNL18.
LED Light Switch	Two Position On / Off
Activation Switch	Momentary
AC Mains Voltmeter	Three Digits Digital
AC Mains Current Meter	Three Digits Digital
Indicators	System On, External Trigger Mode, Slave Mode
EVS Bypass	Extreme Voltage Shut Off Auto Reset or Manual Reset
Emergency Power Down	Requires Hard Switch Contact Closure
Power Supply	External Wide Range 100V - 240VAC, UL Approval
Remote Activation Trigger	5-24VDC Continuous 10 mA, Switch Contacts, Euro / Phoenix Type Connector
Height	1¾" (44.45mm)
Width	19" (482.6mm)
Depth	10" (254mm)



ECS-6RM^B



ECS-6RM^B Back

TSD-SEQ6

Features

- 6 Sequenced Outputs
- Assignable 24VDC or Hard Switch Contact Closure (CC) per Output
- Sequence 1 is Adjustable: Delay Time 1 Second to 10 Minutes
- Sequences 2 - 6 are Adjustable: Delay Time 1 Second to 1 Minute
- Remote Activation via 5-24VDC, Momentary Contacts, Hard Switch Contacts
- Status Indicator for Each Output
- Emergency Power Down "EPD" Port
- Link Out for Two TSD-SEQ6 Controllers
- Voltage Output for Remote LED Status Display
- Separate Wiring Port for Each I/O
- Cable Management System
- Multiple Mounting Configurations
- Removable Phoenix Style I/O Connectors
- Meets Most Energy Standards
- Compact Chassis Design

Specifications

Chassis Construction	Black Aluminum
Sequence Status Indicator	Green, Quantity 1
Output Status Indicator	Red, Quantity 6
Voltage	24VDC, 500mA
Power Consumption Current	100mA
Power Consumption Watts	2.4 Watts
Height	1½" (39mm)
Width	4" (101mm)
Depth	2¾" (70mm)
Weight	6oz. (.165kg)



TSD-SEQ6



TSD-SEQ6 Back

ECM-2063

Features

- 6 Separate 120V Outlet Sections
- 12, 120VAC 20A Outlets
- Accepts up to three 20A 120VAC Lines, Configurable
- Incoming AC present LED
- Active LED
- Remote or Local Activation
- Hard Switch Contact Closure Trigger
- 6 Dual Knockouts ½" & ¾"
- 4 Rail Mounting Tabs

Specifications

AC Outlets	12 NEMA 5-20, Switched
Voltage	120V AC, 60Hz
Load	20A + 20A + 20A Configurable
Power Consumption	5.1 Watts Standby, 11.3 Watts Active
Height	2¾" (65.79mm)
Width	3¼" (82.80mm)
Length	36⅞" (935.74mm)
Weight	10 lbs. (4.54kg)
Certification	UL60065

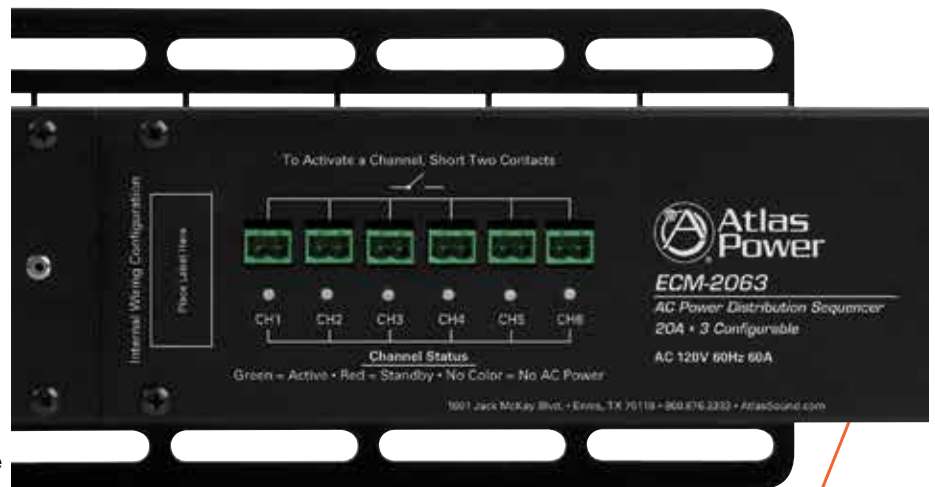

ECS-3

Features

- 3 Sequencer Timing Sections Fixed 3-Second Intervals, 6 Seconds Total
- 9 Total Outlets Are Provided
 - 6 Rear Panel Outlets Are Sequenced In Three Steps
 - 2 Front Panel and 1 Rear Panel Unswitched Convenience Outlets
- Radio Frequency Interference (RFI) Noise Filtering
- Electromagnetic Interference (EMI) Filtering
- Dual Clamping Spike & Surge Suppression, DCS Circuitry
- Front Panel Digital AC Mains Voltmeter
- LED Indication of Reversed “Live” and “Neutral” Wiring
- Abnormal AC Line Voltage Indicator for Voltages Between 102VAC–107VAC or 128VAC–132VAC
- Extreme Voltage Shutdown (EVS) Below 102VAC or Above 132VAC Line
- Circuit Breaker Protection @ 15A Indicated by “Breaker Open” Indicator
- Front Mounted Pull-out LED Light with 2-Position Dimmer
- 24VDC Sequence Trigger Output for Optional ECM Modules
- Rear Mounted XLR Connector for 12VDC LED Lamp (Part Number AP-GNL18 Sold Separately)

Specifications

Outlets	NEMA 5-15R Quantity 9
Current Rating	15 Amps
Operating Voltage	102-132VAC
Minimum Spike Clamping Voltage	460VRMS @ 3000A
Maximum Spike Clamping Voltage	6000V
Power Consumption	12 Watts
Height	1¾" (44.5mm)
Width	19" (482.6mm)
Depth	8½" (215.9mm)
Safety Listing	UL1449



AP-GNL18

Also Available

AP-GNL18 16" XLR Connector Gooseneck LED Lamp for ECS-6RM[®], ECS-3, AP-S15L, and AP-C15D



ECS-3



ECS-3 Back



Atlas Sound Electrical Control Modules offer integrators an array of options to meet the electrical needs of any installation. Designed to be used as standalone units or in conjunction with Atlas Sound sequencers, ECM units include electrical surge protection as well as interference filters resulting in optimal performance from all connected devices.



ECM-RACEWY6 Rack Mounted in Atlas Sound 700 Series Rack with Sequenced Connections to ECS-6RM[®]

Atlas Power ECM Electrical Control Modules

Applications

The Atlas Power Electrical Control Modules (ECM) are designed to meet the electrical needs of many different installation scenarios. These models can be used individually or in conjunction with each other anywhere that power delivery and surge protection is required including restaurants, houses of worship, schools, industrial facilities, and office buildings.

Features

- Multiple Sequencing Timing Sections
- Manual / Auto On/Off Switch
- Incoming AC Present LED
- Active LED
- AC Spike & Surge Suppression
- Extreme Voltage Shutdown Circuitry
- AC Mains Voltage Monitoring

General Description

Atlas Sound Electrical Control Modules (ECM) are power conditioner and AC spike suppressors that are designed to be used as standalone units or in conjunction with an Atlas power sequencing unit. These units are available in 15A, 20A, and 30A configurations allowing them to address the power requirements for most installations.

All Atlas Sound Electrical Control Modules feature "Manual On" / "External Trigger" that allow them to be controlled from the unit or remotely by an Atlas Sound power sequencer. Each unit has visual LED indicators that illustrate when AC power is present and when the unit is active. When connected to the ECS-6RM[®] each ECM will allow for AC Mains voltage monitoring. Additionally, each ECM utilizes Extreme Voltage Shutdown technology and can be turned Off by the sequencer if a voltage swing occurs above 128VAC or below 101VAC. AC Spikes, or Transients, are commonly caused by lightning storms or utility power plant grid switchovers. The amount of energy that can be injected into the power system can be immense with voltages reaching 6KV or amperage peaks of 3000A. These spikes are very fast and usually only last for a very short period of time. To protect against this potential problem, all ECM models feature suppression technology that protects against line to neutral, line to ground, and neutral to ground protection. If a spike intrudes the AC system, the circuitry can suppress unwanted energy within a nanosecond, while sustaining the suppression up to 2 milliseconds, thus ensuring virtually trouble free protection. All models are MET listed.

The ECM-20M, ECM-20SH, and ECM-15SH are electrical control modules that offer additional features. These features include noise filtering for unwanted Radio Frequency Interference (RFI) that is commonly introduced into the AC lines by nearby radio transmitters or wireless products. Electromagnetic Interference (EMI) filters are incorporated to reduce noise from items including electric motors, switching power supplies and lightning.

The ECM-20, ECM-20M, and ECM-30 require a mechanical housing to be operated properly. Atlas offers three versions the ECM-RACEWY1, ECM-RACEWY3, and ECM-RACEWY6 to accomplish this. Each model can support differing numbers of ECM modules to accommodate individual installation requirements.



ECM-20

Features

- Dual 20A Outlet NEMA 5-20R
- Manual / Auto ON/OFF Switch
- Incoming AC Present LED
- Active LED
- Clamping Spike & Surge Suppression
- AC Mains Voltage & Current Monitoring



Specifications

Current Rating	20 Amps
Operating Voltage	102-132VAC
Minimum Spike Clamping Voltage	460VRMS @ 3000A
Maximum Spike Clamping Voltage	6,000V
Power Consumption	.5 Watts
Power Requirements	120V 60Hz
Height	3" (76.2mm)
Width	8½" (215.9mm)
Depth	3½" (88.9mm)
Weight	1.25 lbs. (.68 kg)
Safety Listing	UL1449

ECM-20M

Features

- Dual 20A Outlet NEMA 5-20R
- Manual / Auto ON/OFF Switch
- Incoming AC Present LED
- Active LED
- AC Fault LED
- Clamping Spike & Surge Suppression
- Radio Frequency Interference (RFI) Noise Filtering
- Electromagnetic Interference (EMI) Filtering



Specifications

Current Rating	20 Amps
Operating Voltage	102-132VAC
Minimum Spike Clamping Voltage	460VRMS @ 3000A
Maximum Spike Clamping Voltage	6,000V
Power Consumption	.5 Watts
Power Requirements	120V 60Hz
Height	3" (76.2mm)
Width	8½" (215.9mm)
Depth	3½" (88.9mm)
Weight	1.75 lbs. (.80 kg)
Safety Listing	UL1449

ECM-30

Features

- Single 30A Outlet NEMA 5-30R
- Manual / Auto ON/OFF Switch
- Incoming AC Present LED
- Active LED and AC Fault LED
- AC Fault LED
- Clamping Spike & Surge Suppression



Specifications

Current Rating	30 Amps
Operating Voltage	102-132VAC
Minimum Spike Clamping Voltage	460VRMS @ 3000A
Maximum Spike Clamping Voltage	6,000V
Power Consumption	.5 Watts
Power Requirements	120V 60Hz
Height	3" (76.2mm)
Length	8½" (215.9mm)
Depth	3½" (88.9mm)
Weight	1.25 lbs. (.68 kg)
Safety Listing	UL1449

RACEWY

Features

- ECM-RACEWY6 Holds Up To 6 ECM-20, ECM-20M, or ECM-30 Modules
- ECM-RACEWY3 Holds Up To 3 ECM-20, ECM-20M, or ECM-30 Modules
- ECM-RACEWY1 Holds 1 ECM-20, ECM-20M, or ECM-30 Modules
- 4 AC Inlet Locations
- Dual Knockouts ½" & ¾"
- 4 (ECM-RACEWY6 & ECM-RACEWY3) or 2 (ECM-RACEWY1) Breakaway Rail Mounting Tabs



Specifications

ECM-RACEWY1	
Height	5⅞" (141mm)
Length	13¾" (349.8mm)
Depth	3⅝" (93mm)
ECM-RACEWY3	
Height	5⅞" (141mm)
Length	30¾" (781.1mm)
Depth	3⅝" (93mm)
ECM-RACEWY6	
Height	5⅞" (141mm)
Length	56½" (1435mm)
Depth	3⅝" (93mm)



Also Available

- ECM-3BP ECM-RACEWY6 Module Blank Cover Plate
- ECM-ACIN 40", Stranded 12-Gauge UL Wire for Wiring the ECM-20 / ECM-20M / ECM-30 Modules



ECM-20SH

Features

- 2 Outlets, 20A NEMA 5-20R
- Radio Frequency Interference (RFI) Noise Filtering
- Electromagnetic Interference (EMI) Filtering
- Spike & Surge Suppression
- Extreme Voltage Shutdown (EVS) Below 102V or Above 132V AC Line
- AC Fault indicator
- Fuse Protection @ 20A Slow Blow
- Manual Bypass Switch
- Incoming AC Present LED
- Active Outlet LED
- Status Signals Output for Voltage and Current



Specifications

Current Rating	20 Amps
Operating Voltage	102-132VAC
Minimum Spike Clamping Voltage	460VRMS @ 3000A
Maximum Spike Clamping Voltage	6000V
Power Consumption	5 Watts
Power Requirements	120V 60Hz
Height	3" (76.2mm)
Width	8½" (215.9mm)
Depth	3½" (88.9mm)
Weight	5.5 lbs (2.49 kg)
Safety Listing	UL1449

ECM-15SH

Features

- 2 Outlets, 15A NEMA 5-15R
- Radio Frequency Interference (RFI) Noise Filtering
- Electromagnetic Interference (EMI) Filtering
- Spike & Surge Suppression
- Extreme Voltage Shutdown (EVS) Below 102V or Above 132V AC Line
- AC Fault Indicator
- Fuse Protection @ 15A Slow Blow
- Manual Bypass Switch
- Incoming AC Present LED
- Active Outlet LED
- Status Signals Output for Voltage and Current
- Compact to Fit Behind Flat Screens

Specifications

Current Rating	15 Amps
Operating Voltage	102-132VAC
Minimum Spike Clamping Voltage	460VRMS @ 3000A
Maximum Spike Clamping Voltage	6000V
Power Consumption	.5 Watts
Power Requirements	120V 60Hz
Height	1¾" (44.5mm)
Width	8½" (215.9mm)
Depth	5" (127mm)
Weight	4.5 lbs (2.04kg)
Safety Listing	UL1449





Keyed Remote Activation Switches

ECS-KSW6 Remote Control Key-Switch Panel

This panel can be placed several hundred feet away from the ECS-6RM[®] controller. A keyed On/Off switch is provided for security. There are six Bi-Color LEDs on the ECS-KSW6 panel. One LED for each of the six sequenced channels of the ECS-6RM[®]. These LEDs mimic the Channel Activation LEDs that are on the front of the ECS-6RM[®] panel.

ECS-KSW3M Remote Control Key-Switch Panel

This panel can be placed several hundred feet away from the ECS-3 sequencer. A keyed momentary On/Off switch is provided for security. There is a single LED indicator that illustrates system status.

ECS-KSW6

Features

- 6 Bi-Color LEDs Represent Channels on ECS-6RM[®]
- Access Via Keyed On/Off for Security
- Contemporary Silver, Brushed Stainless Steel Finish

Specifications

Height	4½" (114.3mm)
Width	2¾" (69.85mm)
Connection	RJ45
Weight	.25 lbs. (.5 kg)

ECS-KSW3M

Features

- Red LED ON/OFF Indicator
- Access Via Keyed ON/OFF for Security
- Neutral Black Finish
- Works with the ECS-3

Specifications

Height	4½" (114.3mm)
Width	2¾" (69.85mm)
Connection	Tinned Leads
Weight	.25 lbs. (.5 kg)



WPD-KSWCC / WPD-KSWM

Features

- White Decor Style Plate, ABS Material
- Fits a Single Gang Electrical Outlet
- Designed for Remote Activation of Atlas Power Products
- System Status Indicator (Red)
- 4-Conductor Interface Connection
- Industrial Tubular Key Switch Type
- Label Guard
- Hard Contact Closure (CC) or Momentary (M) Closure Available
- Removable 4 Position Phoenix Style Connector, 5.08mm Pin Spacing

Specifications

Height	4½" (114.3mm)
Width	2¾" (69.85mm)
Connection	Phoenix Style Connector
Weight	.25 lbs. (.5 kg)



WPD-SWCC / WPD-SWM

Features

- White Decor Style Plate, ABS Material
- Fits a Single Gang Electrical Outlet
- Designed for Remote Activation of Atlas Power Products
- System Status Indicator (Red)
- 4-Conductor Interface Connection
- Label Guard
- Push Button Switch Style
- Hard Contact Closure (CC) or Momentary (M) Closure Available

Specifications

Height	4½" (114.3mm)
Width	2¾" (69.85mm)
Connection	Phoenix Style Connector
Weight	.25 lbs. (.5 kg)





Many installations require a more economical approach to power distribution. Atlas Sound vertical power management solutions offer models with different configurations of power receptacles as well as models that include circuit breaker protection and interference filters. All vertical power strips easily integrate into any rack with included hardware.

Atlas Power Vertical Power Strips

Applications

The Atlas Sound vertical power strips are designed to be economical power management solutions that can be easily mounted within a rack. These models can be used anywhere that power delivery and surge protection is required including restaurants, houses of worship, schools, industrial facilities, and office buildings.

Features

- Multiple Outlet Spacing That Accepts Most Power Supply Sizes and Pin Orientation to Achieve Maximum Use of AC Outlets
- Two AC Outlet Orientations: "In Line" and "90 Degree to Chassis"
- 15A or 20A Current Load Models
- Lighted Main Power Switch
- Circuit Breaker Protection
- Radio Frequency Interference (RFI) Noise Filtering
- AC Protect Indicator
- UL, cUL Listed

General Description

This family of power distribution products includes multiple models to meet many types of installation requirements in a compact, space-saving design. Both 15A and 20A models are available in lengths of 24", 48", and 72".

Atlas Power Vertical Power Strips offer complete power / management, multiple outlet spacing and orientation, and RFI filtering as well as spike / surge protection.

AP-7230-15S Is Easily Rack Mounted and Outlet Spacing and Orientation Options Make Equipment Connection Easy



AP-2410-15S

Features

- 10 Available 15A Outlets
- Two AC Outlet Orientations: "In Line" and "90 Degree to Chassis"
- Lighted Main Power Switch
- Circuit Breaker Protection
- Three-way Surge Suppression MOV Protection: H-N, H-G, N-G
- Radio Frequency Interference (RFI) Noise Filtering
- AC Protect Indicator
- UL, cUL Listed

Specifications

Outlets	NEMA 5-15R, Quantity 10
Power Cord	9' (2.74m), 12-Gauge, AC Plug NEMA 5-15P
Load Rating	1875 Watts
MAX Current Protection	15A AC Mains Breaker
Voltage Protection Rating	L-N: 500V, L-G: 500V, N-G: 500V/3kA, 8/20 μ s
Energy Rating	450 Joules, 8/20 μ s
Power Consumption	.5 Watts
Length	24" (609mm)
Width	1 $\frac{5}{8}$ " (41.1mm)
Height	1 $\frac{1}{4}$ " (31.75mm)
Weight	2.1 lbs (.99kg)



AP-2410-20S

Features

- 10 Available 20A Outlets
- Two AC Outlet Orientations: "In Line" and "90 Degree to Chassis"
- Lighted Main Power Switch
- Circuit Breaker Protection
- Three-way Surge Suppression MOV Protection: H-N, H-G, N-G
- Radio Frequency Interference (RFI) Noise Filtering
- AC Protect Indicator
- UL, cUL Listed

Specifications

Outlets	NEMA 5-20R, Quantity 10
Power Cord	9' (2.74m), 12-Gauge, AC Plug NEMA 5-20P
Load Rating	2500 Watts
MAX Current Protection	20A AC Mains Breaker
Voltage Protection Rating	L-N: 500V, L-G: 500V, N-G: 500V/3kA, 8/20 μ s
Energy Rating	450 Joules, 8/20 μ s
Power Consumption	.5 Watts
Length	24" (609mm)
Width	1 $\frac{5}{8}$ " (41.10mm)
Height	1 $\frac{1}{4}$ " (31.75mm)
Weight	2.6 lbs (1.2kg)



AP-4820-15S

Features

- 20 Available 15A Outlets
- Two AC Outlet Orientations: "In Line" and "90 Degree to Chassis"
- Lighted Main Power Switch
- Circuit Breaker Protection
- Three-way Surge Suppression MOV Protection: H-N, H-G, N-G
- Radio Frequency Interference (RFI) Noise Filtering
- AC Protect Indicator
- UL, cUL Listed

Specifications

Outlets	NEMA 5-15R, Quantity 20
Power Cord	9' (2.74m), 12-Gauge, AC Plug NEMA 5-15P
Load Rating	1875 Watts
MAX Current Protection	15A AC Mains Breaker
Voltage Protection Rating	L-N: 500V, L-G: 500V, N-G: 500V / 3kA, 8/20 μ s
Energy Rating	450 Joules, 8/20 μ s
Power Consumption	.5 Watts
Length	48" (1219.20mm)
Width	1 $\frac{5}{8}$ " (41.10mm)
Height	1 $\frac{1}{4}$ " (31.75mm)
Weight	3.3 lbs (1.5kg)



AP-4820-20S

Features

- 20 Available 20A Outlets
- Two AC Outlet Orientations: "In Line" and "90 Degree to Chassis"
- Lighted Main Power Switch
- Circuit Breaker Protection
- Three-way Surge Suppression MOV Protection: H-N, H-G, N-G
- Radio Frequency Interference (RFI) Noise Filtering
- AC Protect Indicator
- UL, cUL Listed

Specifications

Outlets	NEMA 5-20R, Quantity 20
Power Cord	9' (2.74m), 12-Gauge, AC Plug NEMA 5-20P
Load Rating	2500 Watts
MAX Current Protection	20A AC Mains Breaker
Voltage Protection Rating	L-N: 500V, L-G: 500V, N-G: 500V / 3kA, 8/20 μ s
Energy Rating	450 Joules, 8/20 μ s
Power Consumption	.5 Watts
Length	48" (1219.20mm)
Width	1 $\frac{5}{8}$ " (41.10mm)
Height	1 $\frac{1}{4}$ " (31.75mm)
Weight	3.8 lbs (1.74kg)



AP-7230-15S

Features

- 30 Available 15A Outlets
- Two AC Outlet Orientations: "In Line" and "90 Degree to Chassis"
- Lighted Main Power Switch
- Circuit Breaker Protection
- Three-way Surge Suppression MOV Protection: H-N, H-G, N-G
- Radio Frequency Interference (RFI) Noise Filtering
- AC Protect Indicator
- UL, cUL Listed

Specifications

Outlets	NEMA 5-15R, Quantity 30
Power Cord	9' (2.743m), 12-Gauge, AC Plug NEMA 5-15P
Load Rating	1875 Watts
MAX Current Protection	15A AC Mains Breaker
Voltage Protection Rating	L-N: 500V, L-G: 500V, N-G: 500V / 3kA, 8/20 μ s
Energy Rating	450 Joules, 8/20 μ s
Power Consumption	.5 Watts
Length	72" (1828.8mm)
Width	1 $\frac{5}{8}$ " (41.10mm)
Height	1 $\frac{1}{4}$ " (31.75mm)
Weight	4.6 lbs (2.1kg)



AP-7230-20S

Features

- 30 Available 20A Outlets
- Two AC Outlet Orientations: "In Line" and "90 Degree to Chassis"
- Lighted Main Power Switch
- Circuit Breaker Protection
- Three-way Surge Suppression MOV Protection: H-N, H-G, N-G
- Radio Frequency Interference (RFI) Noise Filtering
- AC Protect Indicator
- UL, cUL Listed

Specifications

Outlets	NEMA 5-20R, Quantity 30
Power Cord	9' (2.74m), 12-Gauge, AC Plug NEMA 5-20P
Load Rating	2500 Watts
MAX Current Protection	20A AC Mains Breaker
Voltage Protection Rating	L-N: 500V, L-G: 500V, N-G: 500V / 3kA, 8/20 μ s
Energy Rating	450 Joules, 8/20 μ s
Power Consumption	.5 Watts
Length	72" (1828.8mm)
Width	1 $\frac{5}{8}$ " (41.10mm)
Height	1 $\frac{1}{4}$ " (31.75mm)
Weight	5.1 lbs (2.32kg)



ACS-1

Features

- 15 Amp Outlet Rating
- 12 Total Outlets
- 6 ft. Power Cord
- Finished in Black Epoxy
- Includes Six Grounded Duplex Outlets for Installation in Equipment Cabinets with Vertical Panel Space Greater Than 36¾"

ACS-2A

- 20 Amp Outlet Rating
- 12 Total Outlets
- 6" Pigtail
- Finished in Black Epoxy
- Includes Six Grounded Duplex Outlets for Installation in Equipment Cabinets with Vertical Panel Space Greater Than 36¾"

Specifications

Height	36¾" (933.5mm)
Width	2⅝" (66.675mm)
Depth	1⅞" (41.275mm)
Shipping Weight	7.00 lbs (3.18 kgs)
Current Rating	15A (ACS-1) 20A (ACS-2A)
Light	No
Mounting Orientation	Vertical
Outlets	12



RAC-5 / RAC-5B

Features

- 5 Duplex Outlets - 15 Amp Capacity Total
- Slimline Vertical Power Strip with 6' Power Cord
- Slimline Vertical Power Strip with 6" Pig Tails for Interfacing to Junction Boxes (RAC-5B)

Specifications

Height	16⅞" (409.575mm)
Width	1½" (38.1mm)
Depth	2" (50.8mm)
Shipping Weight	2.50 lbs (1.13 kgs)
Current Rating	15A
Light	No
Mounting Orientation	Vertical
Outlets	5





Atlas Sound modular and zone powered relay packs offer contractors and integrators several options when it comes to incorporating selective speaker activation in both new and legacy systems. Atlas RPM / RLM and PSR series products provide the needed connections and power to connect almost any system.

Atlas Sound Modular and Zone Powered Relay Packs

Applications

The RPM / RLM Series is a modular relay pack line that offers configuration flexibility in reference to number of relays, relay type, and built-in expansion. There are two basic chassis models (RPM-2, and -4) and two types of plug-in relays (RLM-24, RLM-24-5). Modular units are ideal for application where a 24VDC, DPDT relay is required, including institutional, industrial, corporate, and manufacturing facilities, where zone paging, background music, intercom, and telephone systems are used.

RLM-24 and RLM-24-5 are 24VDC plug-in relays equipped with three, and five amp contacts, respectively. The PSR Series PSR-206 and PSR-212 are zone-page, powered relay-pack units with an internal power supply. These relays are commonly used in communication applications where selective activation of speakers is needed. Models are designed to be used with Atlas Sound's MPC Series (Modular Paging Communications Center) for zone paging in restaurants, reception areas, professional offices, health clubs, production, and customer service departments.

Features

- RPM/RLM
 - Modular Design Provides Configuration & Expansion Flexibility
 - Easy to Install Relay Chassis
- PSR
 - Easy Conversion for All-Page Applications
 - Available in 12 or 24 Watt Versions
 - Pre-Mounted and Wired to Power Supply

General Description

Chassis Models RPM-2 and RPM-4 have provisions for 2 and 4 relays respectively. One side of each relay coil is terminated on the same terminal, eliminating the need for bussing. These units have painted steel chassis with rugged fiberglass printed circuit boards. All relay contacts are clearly silk screened on each PC board for easy circuit wiring and are terminated on barrier-type screw terminals to prevent accidental shorting. Chassis are equipped with insta-mount tape for quick and easy installation on most surfaces.

The PSR-206 is a zone page, powered relay-pack with an internal power supply. The unit is completely wired and ready for mounting. The power supply is capable of delivering 500mA at 24VDC. A fuse is used for extra protection. The output of the power supply is terminated at the terminal strip as well as internally to the relay coils. This allows the use of excess power supply capacity for external relays. Six 24VDC, DPDT relays are pre-mounted and wired to the power supply. Any relay may be easily converted to an "all page" relay by connecting the Off bus to the selected relay-switch output.

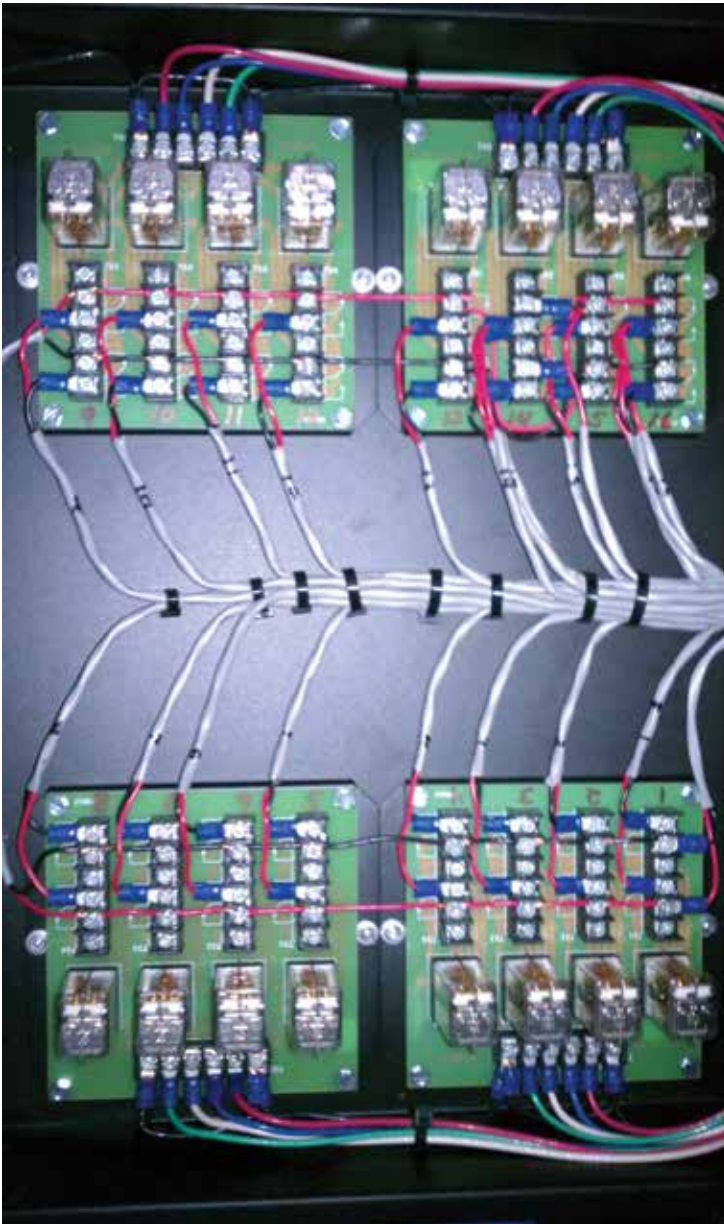

Atlas Sound RPM-4's and RLM-24 deployed in speaker selector system.

RLM-24

Features

- Ideal for Zone Paging Applications
- Plugs directly into Atlas Sound RPM Series Relay Chassis
- Select 3 Amp 24VDC Relays

Specifications

Shipping Weight 0.06 lbs (0.03 kgs)

Contact Rating 3Amps

Input Power 24VDC @ 35mA

Relay DPDT



RPM-2

Features

- Choose From Two Chassis Models
- Easy to Install Relay Chassis
- Modular Design Provides Configuration & Expansion Flexibility
- Select 3 Amp or 5 Amp 24VDC Relays

Specifications

Height $1\frac{5}{16}$ " (23.8mm)

Width $4\frac{3}{4}$ " (120.65mm)

Depth $4\frac{3}{4}$ " (120.65mm)

Shipping Weight 0.50 lbs (0.23 kgs)

Relay 2



RLM-24-5

Features

- Ideal for Zone Paging Applications
- Plugs directly into Atlas Sound RPM Series Relay Chassis
- Select 5 Amp 24VDC Relays

Specifications

Shipping Weight 0.06 lbs (0.03 kgs)

Contact Rating 5Amps

Input Power 24VDC @ 35 mA

Relay DPDT



RPM-4

Features

- Choose From Two Chassis Models
- Easy to Install Relay Chassis
- Modular Design Provides Configuration & Expansion Flexibility
- Select 3 Amp or 5 Amp 24VDC Relays

Specifications

Height $1\frac{5}{16}$ " (23.8mm)

Width $5\frac{1}{2}$ " (139.7mm)

Depth $4\frac{3}{4}$ " (120.65mm)

Shipping Weight 1.00 lbs (0.45 kgs)

Relay 4



PSR-206

Features

- Capacity for Additional External Relays or Lights
- Six 24VDC DPDT Relay Models
- Easy Conversion for All-Page Applications
- Pre-mounted and Wired to Power Supply

Specifications

Height	4 $\frac{3}{8}$ " (111.125mm)
Width	13 $\frac{1}{4}$ " (336.55mm)
Depth	2 $\frac{1}{4}$ " (57.15mm)
Shipping Weight	5.00 lbs (2.27 kgs)
Contact Rating	3Amps
Input Power	117VAC, @ 60Hz, 12 Watts
Output Power	24VDC .5Amp
Relay	6



PSR-212

Features

- Capacity for Additional External Relays or Lights
- Twelve 24VDC DPDT Relay Models
- Easy Conversion for All-Page Applications
- Pre-mounted and Wired to Power Supply

Specifications

Height	4 $\frac{3}{8}$ " (111.1mm)
Width	17 $\frac{1}{8}$ " (435mm)
Depth	2 $\frac{1}{4}$ " (57.15mm)
Shipping Weight	7.50 lbs (3.40 kgs)
Contact Rating	3Amps
Input Power	117VAC, @ 60Hz, 24 Watts
Output Power	24VDC 1Amp
Relay	12





For over 10 years, the industry's most respected and specified loudspeakers have been the Strategy Series® II.

FAP / Strategy Series® II

Applications

Acoustic consultants and design build contractors have used FAP speakers in countless airports, hospitals, educational, retail and hospitality applications due to their accurate frequency response and ease of installation. When compared to higher cost competitors, the FAPs deliver with the best overall sound and the greatest value.

Features

- Extended Low Frequency Response In Optimally Tuned and Ported Enclosure
- Durable Polypropylene Woofer Cones
- Easy Drop or Sheetrock Ceiling Installation via C-Ring/V-Rail Tile Bridge and "Dog Leg" Mounting System (Included)
- Unique "Trap Door" Input Section for Rigid or Flex Conduit Runs
- Inputs Feature a 4-Pole Phoenix Style Connector for Easy Daisy Chaining Between Speakers
- Cover Includes Combination 1.2"/3.4" (13mm/19mm) Knock-Outs for Installation Ease
- Easy to Install Press-Fit Grilles
- Enhanced 70.7V/100V Internal Transformer with 8Ω Bypass
- Front Tap Selector Switch Allows for Easy System Tuning Adjustments



General Description

Atlas Sound offers several different speaker styles and sizes in the FAP series. The FAP42T, FAP62T, and FAP82T are coaxial models that offer outstanding performance and intelligibility in a variety of applications. These speakers feature up to 130° dispersion and have 70.7V/100V power taps up to 60 watts, reducing the number of speakers needed while still achieving outstanding, uniform coverage. All models are available with a white grille and bezel and the FAP42T is also available with a black grille and bezel finish (-B). Additionally, Atlas Sound offers two models that are safety listed to both UL1480 and UL2043, for use in air handling spaces, the FAP42T-UL2043 and FAP62T-UL2043.

When space limitations are a factor in selecting a ceiling speaker, Atlas offers the FAP42TC and FAP40T. The FAP42TC is the ideal speaker choice for applications when space above the plenum is limited but high fidelity and even coverage are requirements. This speaker system has an overall depth of only 4" (108mm) allowing it to additionally be used in wall mount applications where appropriate. The FAP42TC is also offered in a model that is safety listed to UL2043 and UL1480, the FAP42TC-UL2043. In retrofit applications Atlas Sound also offers the FAP42-RR retro ring accessory that allows the FAP42TC and FAP42T to be installed into a typical 8" loudspeaker cutout up to 12". The FAP40T is a single cone driver that has a very compact footprint. This unit includes front mounted 70.7V/100V selector switch with taps up to 16 watts that acts as a diffuser providing even dispersion. A tile bridge is included with the FAP40T that can be used in suspended ceiling applications eliminating the need for additional supports. The FAP40T is also available with a black bezzel and grille, model FAP40T-B.

The FAP8CXT compression driver coaxial in-ceiling speaker is available for applications with higher ceilings or where greater output is required. This model features a tuned and ported enclosure as well as a heavy-duty "dog leg" mounting system. The FAP8CXT provides 90° pattern control accurately in the 2kHz octave band via the 1" exit high frequency director. The FAP8CXT is capable of delivering up to 60 watts via the integrated 70.7V/100V transformer.

For applications that require enhanced low frequency reproduction Atlas offers the FAPSUB-1. Many commercial establishments like retail shops, restaurants, and hospitality settings require higher fidelity sound as a means of engaging and interesting their customers. The FAPSUB-1 is able to deliver omnidirectional low frequency sound as a complement to the full range sound provided by other FAP speaker systems. This unit features an extended, vented pole piece that enables the unit to achieve higher excursion and improved heat dissipation. This unit includes a tuned and ported enclosure that enables it to reproduce frequencies as low as 45Hz. The integrated 70.7V transformer and front mounted tap selector allow the speaker to handle up to 60 watts.





Atlas Provided FAP42Ts for the White House Press Room



McCormick Place West Building - Chicago, IL Includes Hundreds of Atlas Speakers

FAP40T-B



Features

- 16 Watt Internal Transformer
- 8Ω Transformer Bypass Setting
- Input Via 2 Pole Terminal Strip
- Lightweight Construction Makes Use of Additional Support in Drywall Ceilings Unnecessary
- Low Profile Plastic Enclosure
- Press-Fit Grille Blends Perfectly Into Contemporary Architecture
- Tile Bridge Include
- Tuned & Ported Design for Extended Bass Response

Specifications

Safety Listing	UL1480
Transformer Taps	1, 2, 4, 8, & 16 Watts/ 8Ω Bypass
Power Handling	16 Watts
Sensitivity (1W/1m)	87dB
Frequency Response	80Hz – 15kHz (±5dB)
Dispersion	130°
New Construction Ring	FA-TR4
Diameter	7 ³ / ₈ " (187mm)
Depth	7 ¹ / ₈ " (181mm)
Cut Out Diameter	6 ⁵ / ₁₆ " (356mm)

FAP40T-B



Features

- 16 Watt Internal Transformer
- 8Ω Transformer Bypass Setting
- Input Via 2 Pole Terminal Strip
- Lightweight Construction Makes Use Of Additional Support In Drywall Ceilings Unnecessary
- Low Profile Plastic Enclosure
- Press-Fit Grille Blends Perfectly Into Contemporary Architecture
- Tile Bridge Include
- Tuned & Ported Design for Extended Bass Response

Specifications

Safety Listing	UL1480
Transformer Taps	1, 2, 4, 8, & 16 Watts/ 8Ω Bypass
Power Handling	16 Watts
Sensitivity (1W/1m)	87dB
Frequency Response	80Hz – 15kHz (±5dB)
Dispersion	130°
New Construction Ring	FA-TR4
Diameter	7 ³ / ₈ " (187mm)
Depth	7 ¹ / ₈ " (181mm)
Cut Out Diameter	6 ⁵ / ₁₆ " (356mm)

FAP42T



Features

- Extended Low Frequency Response from the Optimally Tuned and Ported Deep Drawn, Galvanized Steel Enclosure
- Easy Installation in Drop Tile or Sheetrock Ceilings via C-Ring / V-Rail Tile Bridge and "Dog Leg" Mounting System (Included)
- Front Mounted Tap Selector Switch for Easy System Tuning Adjustments Includes Transformer Bypass Setting for 8Ω / Direct Coupled Operation
- Unique Input Section Allows for Through Conduit Runs with Rigid or Flex Conduit
- 4 Pole Detachable Phoenix Style / Euro Connector Allows Easy Prewiring and is Convenient for Daisy Chaining Additional Strategy Series Full Range Speakers or Subwoofers
- Press-Fit Grille Blends Perfectly Into Contemporary Architecture
- Enhanced Quality 70.7V / 100V Internal Transformer Minimizes Insertion Loss and Maintan Low Frequency Response While Providing Increased Output for Higher SPL Applications
- Also Availalbe in Black Model FAP42T-B

Specifications

Safety Listing	UL1480
Transformer Taps	1,2,4,8, & 16 Watts / 8Ω Bypass
Power Handling	25 Watts
Sensitivity (1W/1m)	88dB
Frequency Response	75Hz – 20kHz(±5dB)
Dispersion	130°
New Construction Ring	FAP42-TR
Diameter	10½" (267mm)
Depth	8⅞" (225mm)
Cut Out Diameter	9" (229mm)

FAP42T-UL2043



Features

- Extended Low Frequency Response From the Optimally Tuned and Ported Deep Drawn, Galvanized Steel Enclosure
- Easy Installation in Drop Tile or Sheetrock Ceilings via C-Ring / V-Rail Tile Bridge and "Dog Leg" Mounting System (Included)
- Front Mounted Tap Selector Switch for Easy System Tuning Adjustments Includes Transformer Bypass Setting for 8Ω / Direct Coupled Operation
- Unique Input Section Allows for Through Conduit Runs with Rigid or Flex Conduit
- 4 Pole Detachable Phoenix Style / Euro Connector Allows Easy Prewiring and is Convenient for Daisy Chaining Additional Strategy Series Full Range Speakers or Subwoofers
- Press-Fit Grille Blends Perfectly Into Contemporary Architecture
- Enhanced Quality 70.7V / 100V Internal Transformer Minimizes Insertion Loss and Maintan Low Frequency Response While Providing Increased Output For Higher SPL Applications

Specifications

Safety Listing	UL1480 / UL2043
Transformer Taps	1,2,4,8, & 16 Watts / 8Ω Bypass
Power Handling	25 Watts
Sensitivity (1W/1m)	88dB
Frequency Response	75Hz – 20kHz(±5dB)
Dispersion	130°
New Construction Ring	FAP42-TR
Diameter	10½" (267mm)
Depth	8⅞" (225mm)
Cut Out Diameter	9" (229mm)

FAP42TC-B



Features

- Press-Fit Grille Blends Perfectly Into Contemporary Architecture
- Easy Installation in Drop Tile or Sheetrock Ceilings Via C-ring/V-rail Tile Bridge and "Dog Leg" Mounting System (Included)
- Enhanced Quality 70.7V/100V Internal Transformer Minimizes Insertion Loss and Maintain Low Frequency Response While Providing Increased Output For Higher SPL Applications
- Front Mounted Tap Selector Switch For Easy System Tuning Adjustments Includes Transformer Bypass Setting for 8Ω Direct Coupled Operation
- Low Depth (4") Speaker System for Limited Space Applications

Specifications

Safety Listing	UL1480
Transformer Taps	1,2,4,8, & 16 Watts / 8Ω Bypass
Power Handling	25 Watts
Sensitivity (1W/1m)	88dB
Frequency Response	75Hz – 20kHz(±5dB)
Dispersion	130°
New Construction Ring	FAP42-TR
Diameter	10½" (267mm)
Depth	4¼" (108mm)
Cut Out Diameter	9" (229mm)

FAP42TC-UL2043



Features

- Press-Fit Grille Blends Perfectly Into Contemporary Architecture
- Easy Installation in Drop Tile or Sheetrock Ceilings Via C-Ring/V-Rail Tile Bridge and "Dog Leg" Mounting System (Included)
- Enhanced Quality 70.7V/100V Internal Transformer Minimizes Insertion Loss and Maintain Low Frequency Response While Providing Increased Output for Higher SPL Applications
- Front Mounted Tap Selector Switch for Easy System Tuning Adjustments Includes Transformer Bypass Setting for 8Ω Direct Coupled Operation
- Low Depth (4") Speaker System For Limited Space Applications

Specifications

Safety Listing	UL1480 / UL2043
Transformer Taps	1,2,4,8, & 16 Watts / 8Ω Bypass
Power Handling	25 Watts
Sensitivity (1W/1m)	88dB
Frequency Response	75Hz – 20kHz(±5dB)
Dispersion	130°
New Construction Ring	FAP42-TR
Diameter	10½" (267mm)
Depth	4¼" (108mm)
Cut Out Diameter	9" (229mm)

FAP62T



Features

- 4 Pole Detachable "Phoenix" Style Connector Allows Easy Pre-Wiring and is Convenient for Daisy Chaining Additional Strategy Full Range Speakers or Subwoofers
- Easy Installation in Drop Tile or Sheetrock Ceilings Via C-Ring/V-Rail Tile Bridge and "Dog Leg" Mounting System (Included)
- Enhanced Quality 70.7V/100V Internal Transformer Minimizes Insertion Loss and Maintain Low Frequency Response While Providing Increased Output for Higher SPL Applications
- Extended Low Frequency Response From The 285 Cubic Inch Optimally Tuned and Ported Deep Drawn Galvanized Steel Enclosure
- Front Mounted Tap Selector Switch for Easy System Tuning Adjustments Includes Transformer Bypass Setting for 8Ω Direct Coupled Operation
- Press-Fit Grille Blends Perfectly Into Contemporary Architecture
- Unique Input Section Allows for Through Conduit Runs with Rigid or Flex Conduit

Specifications

Safety Listing	UL1480
Transformer Taps	2,4,8, 16 & 32 Watts / 8Ω Bypass
Power Handling	50 Watts
Sensitivity (1W/1m)	88dB
Frequency Response	63Hz – 20kHz(±5dB)
Dispersion	110°
New Construction Ring	FAP62-TR
Diameter	12½" (318mm)
Depth	8⅞" (215mm)
Cut Out Diameter	11" (279mm)

FAP62T-UL2043



Features

- 4 Pole Detachable "Phoenix" Style Connector Allows Easy Pre-Wiring and is Convenient for Daisy Chaining Additional Strategy Full Range Speakers or Subwoofers
- Easy Installation in Drop Tile or Sheetrock Ceilings Via C-Ring/V-Rail Tile Bridge and "Dog Leg" Mounting System (Included)
- Enhanced Quality 70.7V/100V Internal Transformer Minimizes Insertion Loss and Maintain Low Frequency Response While Providing Increased Output for Higher SPL Applications
- Extended Low Frequency Response From The 285 Cubic Inch Optimally Tuned and Ported Deep Drawn Galvanized Steel Enclosure
- Front Mounted Tap Selector Switch For Easy System Tuning Adjustments Includes Transformer Bypass Setting For 8Ω Direct Coupled Operation
- Press-Fit Grille Blends Perfectly Into Contemporary Architecture
- Unique Input Section Allows for Through Conduit Runs with Rigid or Flex Conduit

Specifications

Safety Listing	UL1480 / UL2043
Transformer Taps	2,4,8, 16 & 32 Watts / 8Ω Bypass
Power Handling	50 Watts
Sensitivity (1W/1m)	88dB
Frequency Response	63Hz – 20kHz(±5dB)
Dispersion	110°
New Construction Ring	FAP62-TR
Diameter	12½" (318mm)
Depth	8⅞" (215mm)
Cut Out Diameter	11" (279mm)

FAP6260T



Features

- Easy Installation in Drop Tile or Sheetrock Ceilings Via C-Ring/V-Rail Tile Bridge and "Dog Leg" Mounting System (Included)
- Enhanced Quality 70.7V/100V Internal Transformer Minimizes Insertion Loss and Maintain Low Frequency Response While Providing Increased Output for Higher SPL Applications
- Extended Low Frequency Response From The 285 Cubic Inch Optimally Tuned and Ported Deep Drawn Galvanized Steel Enclosure
- Front Mounted Tap Selector Switch for Easy System Tuning Adjustments Includes Transformer Bypass Setting for 8Ω Direct Coupled Operation
- Low Profile, Press Fit, and Magnetically Retained Grille
- Unique Input Section Allows for Through Conduit Runs with Rigid or Flex Conduit

Specifications

Safety Listing	UL1480 (PENDING)
Transformer Taps	3.8, 7.5, 15, 30, & 60 Watts / 8Ω Bypass
Power Handling	75 Watts
Sensitivity (1W/1m)	92dB
Dispersion	60°
Diameter	10.75" (273mm)
Depth	8.5" (216mm)
Cut Out Diameter	9.75" (248mm)

FAP82T



Features

- "Press -Fit" Grille to Better Blend Into Contemporary Architecture
- 4 Pole Detachable "Phoenix" Style Connector Allows Easy Pre-Wiring and is Convenient for Daisy Chaining Additional Speakers
- 60 Watt Enhanced Quality 70.7V/100V Internal Transformer Minimizes Insertion Loss and Maintains Low Frequency Response
- Extended Low Frequency Response from the Optimally Tuned and Ported Deep Drawn Galvanized Steel Enclosure (937 Cubic Inches)
- Front Mounted Tap Selector Switch for Easy System Tuning Adjustments
- Includes C-Ring/V-Rail Tile Bridge Mounting Hardware
- Unique Input Section Allows for Through Conduit Runs with Rigid or Flex Conduit

Specifications

Safety Listing	UL1480
Transformer Taps	1.9, 3.8, 7.5, 15, 30 & 60 Watts / 8Ω Bypass
Power Handling	70 Watts
Sensitivity (1W/1m)	90dB
Frequency Response	55Hz – 20kHz(±5dB)
Dispersion	100°
New Construction Ring	FAP82-TR
Diameter	15¾" (400mm)
Depth	12¾" (324mm)
Cut Out Diameter	14" (356mm)

FAP8CXT



Features

- "Press -Fit" Grille to Better Blend Into Contemporary Architecture
- 1" Exit Compression High Frequency Driver Coupled to a Specially Designed Conical Wave-Guide Horn Provides Exceptional Output & Accurate High Frequency Reproduction
- 90 Degree Conical Dispersion (2kHz Octave Band)
- Extended Low Frequency Response From The Optimally Tuned and Ported Deep Drawn Galvanized Steel Enclosure (937 Cubic Inches)
- Front Mounted Tap Selector Switch for Easy System Tuning Adjustments
- Includes C-Ring/V-Rail Tile Bridge Mounting Hardware
- Unique Input Section Allows for Through Conduit Runs with Rigid or Flex Conduit
- Enhanced Quality 70.7V/100V Internal Transformer Minimizes Insertion Loss and Maintain Low Frequency Response While Providing Increased Output for Higher SPL Applications

Specifications

Transformer Taps	1.9, 3.8, 7.5, 15, 30 & 60 Watts / 8Ω Bypass
Power Handling	150 Watts
Sensitivity (1W/1m)	92dB
Frequency Response	60Hz – 15kHz(±5dB)
Dispersion	100°
New Construction Ring	FAP82-TR
Diameter	15¾" (400mm)
Depth	12¾" (324mm)
Cut Out Diameter	14" (356mm)

FAPSUB-1



Features

- Attractive Grille and Bezel Matches Aesthetics of Other Atlas Sound FAP Series
- Detachable, Phoenix Style, Locking, Four-Pole Connector Provides for Easy Daisy Chain Wiring
- Easy Installation in Drop Tile or Sheetrock Ceilings Via C-Ring/V-Rail Tile Bridge and "Dog Leg" Mounting System (Included)
- Front Mounted Tap Selector Switch for Easy System Tuning Adjustments Includes Transformer Bypass Setting for 8Ω Direct Coupled Operation
- High Efficiency, Passive Crossover Network Eliminates the Need for Dedicated Amplifier and/or Active Crossover
- Low Crossover Point Greatly Reduces Localization (Ability of Listener to Identify the Subwoofer Location)
- Uniquely Designed, "Easy Access" Input Panel Design Allows for "Thru" Conduit Runs Using Flexible or Rigid Conduit

Specifications

Safety Listing	1480
Transformer Taps	1.9, 3.8, 7.5, 15, 30 & 60 Watts / 8Ω Bypass
Power Handling	100 Watts
Sensitivity (1W/1m)	88dB
Frequency Response	55Hz – 150Hz(±6dB)
Dispersion	Omni
New Construction Ring	FAP82-TR
Diameter	15¾" (400mm)
Depth	12¾" (323mm)
Cut Out Diameter	14" (356mm)



Drop in packages are ideal solutions for use in drop tile ceilings that save integrators time and money while still offering excellent sound quality and room coverage.

Drop-In Speaker Packages

Applications

Atlas Sound drop in speaker packages are designed to be used in drop tile and lay in tile applications often found in schools, hospitals, and office buildings. These packages are easy for an integrator to install and come preassembled from the factory.

Features

- Attractive White Mesh Grille Blends in with Most Acoustic Ceiling Tiles
- All in One, Pre-Assembled Unit Drops Into Ceiling Grids to Reduce Installation Time and Costs
- External Tap Selector Switch Reduces Wiring Errors

General Description

The Atlas Sound DT12 1' x 2' drop in speaker system simplifies loudspeaker installation by providing an all-in-one speaker package in acoustic ceiling grids. The system includes the speaker / transformer, enclosure, and grille with an external mounted tap selector switch. The compact 2-unit master pack is designed to save warehouse space. You will enjoy clear, crisp paging and background music from the installation friendly DT12 without compromising building cosmetics.

The Atlas Sound DT122x2ADP is an adapter plate that turns the Atlas Sound DT12 1' x 2' lay in speaker package into a easy to install 2' x 2' speaker package that can replace a entire 2' x 2' acoustical tile. The kit comes with two adapter plates and an additional T-Bar support. The DT122x2ADP is manufactured at the same factory as the DT12 to insure both products match in appearance. You must order both the DT12 and the DT122x2ADP to create an entire 2' x 2' speaker package. Sold in pairs - 4 units. The DT6 from Atlas Sound combines ease of installation, an incredible small footprint with superb intelligibility for speech and music reproduction. This product is part of the "Atlas Means Green" initiative and uses less material and energy to produce and transport than larger alternatives. The wide dispersion 3" speaker covers more ground area than larger 8" speakers and thus requires less speakers to fill an area with high quality sound reproduction.

The 6" x 2' footprint allows quick installation into 2' x 2' or 2' x 4' acoustic tile ceilings and also fits into the Armstrong TechZone ceiling where 6" x 4' linear air diffusers and 6" x 4' recessed light fixtures are installed. The E.O. box cover is smartly positioned to facilitate rigid or flexible conduit. An external tap selector switch allows for easy system tuning by providing quick installer access to the 70.7V tap settings ranging from .25 to 4 watts.



DT12

Features

- 10oz 8" Dual Cone Speaker with 25V/ 70.7V Transformer
- External Tap Selector Switch
- Integral E.O. Box for Conduit or Plenum Wire Termination
- Low Profile Enclosure
- 8Ω Bypass
- ETL Certified, Safety Listed to UL1480

Specifications

Safety Listing	1480 & 2043
Power Taps	.25, .5, 1, 2, 4 Watts & 8Ω Bypass
Frequency Response	85Hz - 8kHz (±5dB)
Speaker Type	8", 10oz Dual Cone
Dispersion	105° - 2kHz Octave Band (-6dB)
Sensitivity	97dB (1W/1m)
Width	12 ⁷ / ₈ " (327mm)
Depth	4 ¹ / ₂ " (114mm)
Height	23 ⁷ / ₈ " (606mm)





DT12-2x2ADP



DT12-2x2ADP

Features

- Spare Rail Included for 2'x4' Installation

Specifications

Width	6" (152mm)
Height	24" (610mm)



DT6



DT6

Features

- Rail Included

Specifications

Frequency Response	90Hz - 20kHz
Sensitivity(1W/1m)	86dB
Width	5.75" (146mm)
Length	23.75" (603mm)
Depth	3.5" (89mm)
Dispersion	120°



Strategy One Series® loudspeaker systems (U.S. Patent #5206464) uniquely combine full-frequency response, cost-efficiency, aesthetics, and easy installation into one complete assembly.

General Description

Atlas Sound offers the high-fidelity FA136 (U.S. Patent #5206464) coaxial, 6" loudspeaker that delivers 50-watts at 8Ω with full frequency response and wide dispersion. These UL listed assemblies are manufactured with high quality materials including a Kevlar®, fiber-reinforced, polypropylene woofer and a Norsorex synthetic rubber surround for high-definition bass, structural integrity, effective damping and weather-resistance. Each unit includes a post-mounted dome tweeter with a mylar diaphragm and Ferro fluid-cooled voice coil for smooth response and excellent power handling capability. The FA136 is also available in two models with integrated 70.7V transformers; the FA136T47 includes power taps up to 4 watts and the FA136T87 includes power taps up to 8 watts. Each FA136 model is designed to work with a variety of Strategy Series baffles including the FA51-6 round 6" grille, FA720-6 round 6" perforated grille, FA730-6 round recessed 6" grille, and FA170-6 square 6" grille. The FA81-6 is a 6" tile-bridge designed to work with the FA136 speakers in drop tile ceilings. The FA136 speakers are compatible with three different recessed enclosures, the FA95-6, FA97-6, and FA97-6NK.

For ordering convenience and for installations requiring products that meet Buy America Act standards, Atlas offers the S162T-USA loudspeaker system package. This single sku includes the FA136T87 coaxial loudspeaker, FA720-6 round 6" perforated grille, FA97-6 recessed enclosure, and FA81-6 tile bridge. Each of the individual components in the package is UL1480 and UL2043 listed for general signaling and plenum ceiling installations. The S162T-USA is assembled in Atlas Sound's commercial manufacturing facility in Ennis, TX.

The 8" FA138 is Atlas Sound's premium Strategy Series® coaxial loudspeaker. This 100-watt 8Ω unit includes a circuit board mounted high-pass/low-pass crossover that produces outstanding sound quality. Model FA138 contains a reinforced polypropylene cone woofer, a custom butyl rubber surround, a 1½" vented Kapton voice coil, a 21 oz. magnet and a ½" mylar-dome Ferro fluid tweeter for clean and powerful weather-resistant performance. The FA138 is also available in three additional models that include integrated 70.7V transformers; the FA138T87 includes power taps up to 8 watts, the FA138T167 includes power taps up to 16 watts, and the FA136T327 includes power taps up to 32 watts. Each FA138 model is designed to work with a variety of Strategy Series baffles including the FA51-8 round 8" grille, FA720-8 round 8" perforated grille, FA730-8 round recessed 8" grille, and FA170-8 square 8" grille. The FA81-8 is a 8" tile-bridge designed to work with the FA138 speakers in drop tile ceilings. The FA138 speakers are compatible with three different recessed enclosures, the FA95-8, FA97-8, and FA97-8NK.

The FA134T87 is a UL listed coaxial 4" (127mm) loudspeaker that handles 25-watts with smooth extended frequency response. The unit's 130° dispersion angle effectively reduces the number of loudspeakers necessary to achieve total coverage in distributed systems with low ceilings. The FA134T87 has been engineered as a system with an integrated 8-watt high performance 70.7V transformer with selectable power taps that delivers a frequency response range of 110Hz-20kHz. The FA134T87 is designed to work with a variety of Strategy Series baffles including the FA51-4 round 4" grille, FA720-4 round 4" perforated grille, FA730-4 round recessed 4" grille, and FA170-4 square 4" grille. The FA81-4 is a 4" tile-bridge designed to work with the FA134T87 speaker in drop tile ceilings. The FA134T87 is compatible with three different recessed enclosures, the FA95-4, FA97-4, and FA97-4NK.



4" Sample System

FA / Strategy Series®

Applications

Strategy One Series® systems are offered in 4", 6", and 8" sizes enabling owners, architects, contractors, and consultants to meet varying sound system requirements. Each Strategy One Series speaker is UL 1480 listed for general signaling (non-fire) when used in combination with UL listed enclosures and baffles.

Features

- Component Loudspeakers, Enclosures, Grilles, and Mounting Accessories Offer Installation Flexibility
- Loudspeakers Available in 4", 6", and 8" Coaxial Full-Range Models
- Front Loading, Easy-to-Install Enclosures
- Push Mount Grilles
- Variety of Mounting Accessories Available



FA134T87



Features

- 4" Coaxial Loudspeaker
- Front Loads into Acoustically-Matched System Enclosure, Plaster or Trim Ring
- Patented System Design Provides Easy Installation
- Wide-Angle Dispersion for Excellent Sound Coverage in Rooms with Low Ceilings
- Safety Listed to UL1480

Specifications

Depth	4" (101.6 mm)
Diameter	5" (127 cm)
Shipping Weight	1.71 lbs (0.77 kgs)
Frequency Response	110Hz- 20kHz (+5dB)
Power Taps	1, 2, 4, & 8 Watts
Speaker Type	Coaxial
Dispersion	130°
Sensitivity	88dB Average, 92dB Peak
Safety Listing	UL1480

4" Compatible Parts



FA51



FA51-4

Height	7 ⁷ / ₈ " (20 cm)
Width	7 ⁷ / ₈ " (20 cm)
Depth	5 ¹ / ₁₆ " (0.80 cm)
Safety Listing	UL1480



FA720



FA720-4

Height	7 ⁷ / ₈ " (20 cm)
Width	7 ⁷ / ₈ " (20 cm)
Depth	5 ¹ / ₁₆ " (0.80 cm)
Safety Listing	UL1480



FA730



FA730-4

Height	7 ⁷ / ₈ " (20 cm)
Width	7 ⁷ / ₈ " (20 cm)
Depth	1 ¹ / ₂ " (1.27 cm)
Safety Listing	UL1480

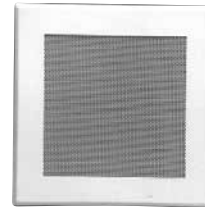

FA170



FA170-4

Height	9 ³ / ₄ " (24.765 cm)
Width	9 ³ / ₄ " (24.765 cm)
Depth	5 ¹ / ₁₆ " (0.79502 cm)
Safety Listing	UL1480



FA97-4



FA97-4(-NK)

Depth	7 ⁵ / ₈ " (19.37 cm)
Diameter	5 ⁵ / ₈ " (13.65 cm)
Safety Listing	UL1480, UL2043



FA95-4



FA95-4(-NK)

Depth	6 ¹ / ₈ " (15.55 cm)
Diameter	5 ⁵ / ₈ " (13.67 cm)
Safety Listing	UL1480, UL2043



FATR-4



FA-TR4

Height	25 ⁵ / ₈ " (65.1 cm)
Diameter	6 ⁵ / ₈ " (16.83 cm)



FAPR-4



FAPR-4

Depth	7 ⁸ / ₁₆ " (2.22 cm)
Diameter	6 ¹ / ₂ " (16.51 cm)
Safety Listing	UL1480



FA136

Features

- Achieves Fidelity Similar to an 8" (203mm) System with Wider Dispersion
- Front Loads into Specially Designed, Acoustically Matched Enclosure
- Offers Choice of System UL Listed Components Including Transformers, Acoustic Enclosure, a Tile Bridge, Plaster Ring and Hardware-Free Grilles
- Patented, Easy-to-Install Loudspeaker Mounting System
- Safety Listed to UL1480

Specifications

Speaker Type	Coaxial
Frequency Response	80Hz- 20kHz (± 5 dB)
Power Taps	8 Ω
Dispersion	130°
Sensitivity	88dB Average, 91dB Peak
Depth	3/4" (8.255 cm)
Diameter	6 7/16" (16.67 cm)
Safety Listing	UL1480



FA136T47

Features

- Achieves Fidelity Similar to an 8" (203mm) System with Wider Dispersion
- Front Loads into Specially Designed, Acoustically Matched Enclosure
- Offers Choice of System UL Listed Components Including Transformers, Acoustic Enclosure, a Tile Bridge, Plaster Ring and Hardware-Free Grilles
- Patented, Easy-to-Install Loudspeaker Mounting System
- Safety Listed to UL1480

Specifications

Speaker Type	Coaxial
Frequency Response	80Hz- 20kHz (+5dB)
Power Taps	.5, 1, 2, 4 Watts
Dispersion	130°
Sensitivity	88dB Average, 91dB Peak
Depth	5 1/8" (13.02 cm)
Diameter	6 7/16" (16.67 cm)
Safety Listing	UL1480



FA136T87

Features

- Achieves Fidelity Similar to an 8" (203mm) System with Wider Dispersion
- Front Loads into Specially Designed, Acoustically Matched Enclosure
- Patented, Easy-to-Install Loudspeaker Mounting System
- Safety Listed to UL1480

Specifications

Speaker Type	Coaxial
Frequency Response	80Hz- 20kHz (+5dB)
Power Taps	1, 2, 4, 8 Watts
Dispersion	130°
Sensitivity	88dB Average, 91dB Peak
Depth	5¼" (13.34 cm)
Diameter	6⅞" (16.67 cm)
Safety Listing	UL1480

6" Compatible Parts



FA51



FA51-6

Diameter	9⅝" (24.45 cm)
Depth	⅝" (0.80 cm)
Safety Listing	UL1480



FA720



FA720-6

Diameter	9⅝" (24.45 cm)
Depth	⅝" (0.80 cm)
Safety Listing	UL1480



FA730



FA730-6

Diameter	9⅝" (24.45 cm)
Depth	½" (1.27 cm)
Safety Listing	UL1480

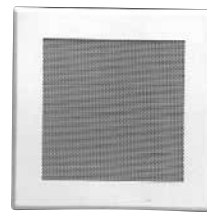

FA170



FA170-6

Height	10⅞" (25.72 cm)
Width	10⅞" (25.72 cm)
Depth	⅝" (0.80 cm)
Safety Listing	UL1480



FA97-6



FA97-6(-NK)

Depth	7⅝" (19.37 cm)
Diameter	7" (17.78 cm)
Safety Listing	UL1480, UL2043



FA95-6



FA95-6(-NK)

Depth	6⅞" (15.56 cm)
Diameter	7" (17.78 cm)
Safety Listing	UL1480, UL2043



FATR-6



FA-TR6

Height	25⅝" (65.1 cm)
Diameter	8⅝" (21.27 cm)
Safety Listing	UL1480



FAPR-6



FAPR-6

Depth	⅞" (2.22 cm)
Diameter	8⅞" (21.12 cm)
Safety Listing	UL1480

FA138



Features

- 100-Watt Unit Offers Extended Sound Pressure Levels for High/Vaulted Ceiling Applications
- Conveniently Front Loads into Acoustically-Matched System Enclosures or Mounting Ring
- Top-of-the-Line 8" Coaxial Loudspeaker Delivers Full-Frequency Response with Superior Fidelity
- Safety Listed to UL1480

Specifications

Speaker Type	Coaxial
Frequency Response	75Hz- 20kHz (+5dB)
Power Taps	8Ω
Sensitivity	89.5dB Average, 93dB Peak
Dispersion	110°
Depth	3 ⁵ / ₈ " (9.14 cm)
Diameter	8 ¹ / ₄ " (21 cm)
Safety Listing	UL1480

FA138T87



Features

- Unit Offers Extended Sound Pressure Levels for High/Vaulted Ceiling Applications
- Conveniently Front Loads into Acoustically-Matched System Enclosures or Mounting Ring
- Top-of-the-Line 8" Coaxial Loudspeaker Delivers Full-Frequency Response with Superior Fidelity
- Safety Listed to UL1480

Specifications

Speaker Type	Coaxial
Frequency Response	75Hz- 20kHz (+5dB)
Power Taps	1, 2, 4, & 8 Watts
Sensitivity	89.5dB Average, 93dB Peak
Dispersion	110°
Depth	5 ¹ / ₂ " (14 cm)
Diameter	8 ¹ / ₄ " (20.cm)
Safety Listing	UL1480

8" Compatible Parts



FA51



FA51-8

Diameter	11 ¹ / ₈ " (28.26cm)
Depth	5 ¹ / ₁₆ " (0.80 cm)
Safety Listing	UL1480



FA730



FA730-8

Diameter	11 ¹ / ₈ " (28.26 cm)
Depth	1 ¹ / ₂ " (1.27 cm)
Safety Listing	UL1480



FA720



FA720-8

Diameter	11 ¹ / ₈ " (28.26 cm)
Depth	5 ¹ / ₁₆ " (0.80 cm)
Safety Listing	UL1480

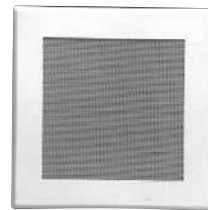

FA170



FA170-8

Height	11 ¹ / ₄ " (28.6 cm)
Width	11 ¹ / ₄ " (28.6 cm)
Depth	5 ¹ / ₁₆ " (0.80 cm)
Safety Listing	UL1480

FA138T167



Features

- Unit Offers Extended Sound Pressure Levels for High/Vaulted Ceiling Applications
- Conveniently Front Loads into Acoustically-Matched System Enclosures or Mounting Ring
- Top-of-the-Line 8" Coaxial Loudspeaker Delivers Full-Frequency Response with Superior Fidelity
- Safety Listed to UL1480

Specifications

Speaker Type	Coaxial
Frequency Response	75Hz- 20kHz (+5dB)
Power Taps	4, 8, & 16 Watts
Sensitivity	89.5dB Average, 93dB Peak
Dispersion	110°
Depth	5¾" (14.6 cm)
Diameter	8¼" (21 cm)
Safety Listing	UL1480

FA138T327



Features

- 8" Loudspeaker System Delivers Efficient Frequency Response
- Conveniently Front Loads into Acoustically-Matched Enclosure, Plaster or Trim Ring
- Patented System Design Provides Easy Installation
- Performance Sensitivity Offers Enhanced Audio Clarity
- Safety Listed to UL1480

Specifications

Speaker Type	Coaxial
Frequency Response	75Hz- 20kHz (+5dB)
Power Taps	8, 16, & 32 Watts
Sensitivity	89.5dB Average, 93dB Peak
Dispersion	110°
Depth	5½" (13.97 cm)
Diameter	8¼" (21 cm)
Safety Listing	UL1480



FA97-8(-NK)

Depth	7⅞" (19.37 cm)
Diameter	8½" (21.59 cm)
Safety Listing	UL1480, UL2043



FA97-6



FA95-8(-NK)

Depth	6⅞" (15.56 cm)
Diameter	8½" (21.6 cm)
Safety Listing	UL1480, UL2043



FA95-6



FA-TR8

Height	25⅞" (65.09 cm)
Diameter	9¾" (24.77 cm)
Safety Listing	UL1480



FATR-6



FAPR-8

Depth	7⅞" (2.22 cm)
Diameter	9¾" (24.77 cm)
Safety Listing	UL1480



FAPR-6

FA42T-6MB



FAP42T-6MB

*(Shown with Optional Enclosure,
Tile Bridge and Grille)*

Features

- 4" Speaker Installs Into 6" Strategy Enclosure
- Designed For Division Of Labor Installations When Enclosures Need To Be Installed Before Speakers Are Installed
- Enhanced Quality 70.7V/100V Internal Transformer Minimizes Insertion Loss and Maintain Low Frequency Response While Providing Increased Output For Higher SPL Applications
- Front Mounted Tap Selector Switch for Easy System Tuning Adjustments
- Motorboard Assembly Has Same Footprint and Bolt-Hole Pattern As 6" Speaker
- Tuned Port Maximizes Low Frequency Response from FA97-6 & FA95-6 Enclosure

Specifications

Safety Listing	UL1480
Power Taps	1, 2, 4, 8, & 16 Watts / 8Ω
Power Handling	25 Watts
Sensitivity	88dB
Frequency Response	75Hz – 20kHz(±7dB)
Dispersion	110°
Matches Enclosure	FA95-6, FA97-6

FA62T-8MB



FAP62T-8MB

*(Shown with Optional Enclosure,
Tile Bridge and Grille)*

Features

- 6" Speaker Installs Into 8" Strategy Enclosure
- Designed For Division Of Labor Installations When Enclosures Need To Be Installed Before Speakers
- Enhanced Quality 70.7V/100V Internal Transformer Minimizes Insertion Loss and Maintain Low Frequency Response While Providing Increased Output For Higher SPL Applications
- Front Mounted Tap Selector Switch For Easy System Tuning Adjustments
- Tuned Port Maximizes Low Frequency Response From FA97-8 & FA95-8 Enclosure

Specifications

Safety Listing	UL1480
Power Taps	2, 4, 8, 16, & 32 Watts / 8Ω
Power Handling	50 Watts
Sensitivity	88dB
Frequency Response	63Hz – 20kHz(±7dB)
Dispersion	110°
Matches Enclosure	FA95-8, FA97-8

FA6260T-8MB



FAP6260T-8MB

*(Shown with Optional Enclosure,
Tie Bridge and Grille)*

Features

- 6" Speaker Installs Into 8" Strategy Enclosure
- Designed For Division of Labor Installations When Enclosures Need To Be Installed Before Speakers

Specifications

Safety Listing	UL1480 (PENDING)
Power Taps	3.8, 7.5, 15, 30, & 60 Watts / 8Ω
Power Handling	60 Watts
Sensitivity	88dB
Frequency Response	80Hz – 20kHz(±7dB)
Dispersion	60°
Matches Enclosure	FA95-8, FA97-8

S162T-USA



Features

- Complete Pre-Assembled 6" Strategy I Package
- Labor Savings with Pre-Assembled Package
- UL1480 and UL2043 Safety Listed
- Meets Buy America Act Criteria

Specifications

Safety Listing	UL1480
Power Taps	1, 2, 4, & 8 Watts
Power Handling	35 Watts RMS
Sensitivity (1W/1m)	88dB Average
Frequency Response	80Hz - 20kHz (±5dB)
Dispersion	110°
Overall Height	7 ⁵ / ₈ " (194mm)



Atlas Sound 4" and 8" speakers are economical solutions for professional sound reinforcement and music systems individual project requirements.

4" & 8" Speakers

Applications

Atlas Sound 4" and 8" loudspeakers are designed to work in a variety of public address or background music applications. These speakers offer a variety of power taps and fit a wide variety of mounting accessories making them ideal for industrial, institutional, and other commercial installations.

Features

- Proven Performance
- 8Ω, 25V, and 70.7V Versions Available
- Mount a Wide Selection of Atlas Enclosures and Baffles



In-ceiling Speakers and BGM Enhance The Customer Experience

General Description

The FC104 is a compact, full-range, 4" (127 mm) loudspeaker equipped with a damped, high-compliance cone, which provides excellent low frequency reproduction and smooth extended response. Model FC104 also offers a wide dispersion angle, which reduces the number of loudspeakers necessary to achieve total coverage in low-level distribution systems. The FC104 is a 10 watt, 8Ω model that offers a frequency response range of 150Hz – 7kHz, sensitivity of 94 dB (1W/1m) and a dispersion angle of 135° (-6 dB, 2 kHz octave band). The unit includes a 10 oz. (283 g) ceramic magnet with a flux density of 10,500 gauss. The FC104 is also available in two versions that include a factory installed line-matching transformer designed to meet a variety of project requirements. The FC104T includes a 70.7V transformer with power taps up to 8 watts and the FC104T72 includes a 25V/70.7V transformer with power taps up to 4 watts. A dual-purpose bracket securely mounts the transformer in a low profile position and enables torsion spring mounting found on many Atlas Sound baffles.

Model C803A is a high-quality, 16-watt coaxial loudspeaker that utilizes a post-mounted tweeter, which adds strength to the assembly and provides an attractive appearance. This 8Ω coaxial loudspeaker features a 70Hz–15.5kHz, (±5dB) frequency response and a broad, uniform dispersion pattern of 120°. These features enable the C803A to reproduce highly intelligible and better distribution for high-quality sound systems. The C803A combines a full-size 8" (203mm) diameter low-frequency reproducer and a 3" (76mm) high-frequency reproducer coupled together via a built-in crossover network. The woofer has a 10oz. (260g) ceramic magnet and the tweeter has a 2.35oz. (67g) ceramic magnet. The unit has a peak sensitivity of 98dB (1W/1m). The loudspeaker is available with five different factory-installed line-matching transformers to meet a variety of project requirements. The C803AT47 includes a 70.7V transformer with power taps up to 4 watts, the C803AT72 includes a 25V/70.7V transformer with power taps up to 4 watts, the C803AT70 includes a 70.7V transformer with power taps up to 5 watts, the C803AT87 includes a 70.7V transformer with power taps up to 8 watts, and the C803AT167 includes a 70.7V transformer with power taps up to 16 watts.

Model C10A is an 8Ω dual cone, 25-watt loudspeaker that includes a curvilinear, treated-paper cone for lower harmonic distortion. The loudspeaker is also equipped with a full 1" diameter copper voice coil with a black-anodized aluminum former for better heat dissipation. Model C10A features a full-size 8" (203mm) diameter cone that operates within a frequency response range of 45Hz–19kHz with a sensitivity of 94dB (1W/1m) and a dispersion angle of 105°. It mounts a wide variety of Atlas Sound round and square baffles and enclosures to meet functional and aesthetic application requirements. The C10A is also available in two versions that include a factory installed line-matching transformer designed to meet a variety of project requirements. The C10AT70 includes a 70.7V transformer with power taps up to 5 watts and the C10AT72 includes a 25V/70.7V transformer with power taps up to 4 watts.

Model C5A is a reliable, economically priced 8Ω, 15-watt loudspeaker that offers many features found in speakers costing considerably more. It includes a curvilinear, treated-paper cone for lower harmonic distortion. It is also equipped with a full 1" diameter copper voice coil with a black anodized aluminum former for better heat dissipation. Model C5A features a full-size 8" (203mm) diameter cone that operates within a frequency response range of 50Hz–18kHz with a sensitivity of 93dB (1W/1m) and a dispersion angle of 105°. It mounts a wide variety of Atlas Sound round and square baffles and enclosures to meet functional and aesthetic application requirements. The C5A is also available in three versions that include a factory installed line-matching transformer designed to meet a variety of project requirements. The C5AT70 includes a 70.7V transformer with power taps up to 5 watts, C5AT25 includes a 25V transformer with power taps up to 5 watts, and the C5AT72 includes a 25V/70.7V transformer with power taps up to 4 watts.



FC104



Features

- Efficient Wide-Range Frequency Response
- Ideal for Public Address and Background Music Installations
- Industry Standard, 10-Watt, 4" High-Compliance Loudspeaker
- Mounts a Large Selection of Atlas Sound 4" Grilles
- Offers Proven Performance with Wide-Angle Sound Dispersion

Specifications

Speaker Type	Paper Cone
Frequency Response	150Hz - 17kHz (±5dB)
Power Taps	8Ω, 10 Watts
Sensitivity (1W/1m)	94dB
Dispersion	135° (-6dB, 2kHz Octave Band)
Depth	2¼" (57mm)
Diameter	4" (102mm)

FC104T



Features

- Efficient Wide-Range Frequency Response
- Ideal for Public Address and Background Music Installations
- Industry Standard, 10-Watt, 4" High-Compliance Loudspeaker
- Mounts a Large Selection of Atlas Sound 4" Grilles
- Offers Proven Performance with Wide-Angle Sound Dispersion
- Versatile 8W, 70.7 V Transformer with .5 to 8W Taps
- Safety Listed to UL1480

Specifications

Speaker Type	Paper Cone
Frequency Response	150Hz - 17kHz (±5dB)
Power Taps	.5, 1, 2, 4, & 8 Watts
Sensitivity (1W/1m)	94dB
Dispersion	135° (-6dB, 2kHz Octave Band)
Depth	4" (102mm)
Diameter	4" (102mm)
Safety Listing	UL1480

FC104T72



Features

- Efficient Wide-Range Frequency Response
- Ideal for Public Address and Background Music Installations
- Includes 4 watt 70-Volt transformer
- Industry Standard, 10-Watt, 4" High-Compliance Loudspeaker
- Mounts a Large Selection of Atlas Sound 4" Grilles
- Offers Proven Performance with Wide-Angle Sound Dispersion
- Safety Listed to UL1480 & UL2043

Specifications

Speaker Type	Paper Cone
Frequency Response	150Hz - 17kHz (±5dB)
Power Taps	.5, 1, 2, & 4 Watts
Sensitivity (1W/1m)	94dB
Dispersion	135° (-6dB, 2 kHz octave band)
Depth	2¼" (57mm)
Diameter	4" (102mm)
Safety Listing	UL1480 & UL2043

C803A

Features

- Ideal for Multi-Purpose Commercial, Industrial, and Institutional Use
- Industry Standard 8" (203mm) Coaxial, 16-Watt, Loudspeaker
- Offers Proven Performance with Wide Frequency Response
- Post-Mounted Tweeter Adds Strength and a More Attractive Appearance



Specifications

Speaker Type	Coaxial
Frequency Response	70Hz - 15.5kHz (±5dB)
Power Taps	8Ω, 16 Watts
Sensitivity	98dB (peak), 95dB (avg)
Dispersion	120°
Depth	2 ⁷ / ₈ " (7.30 cm)
Diameter	8" (20.32 cm)
Safety Listing	UL1480

C803AT47

Features

- Ideal for Multi-Purpose Commercial, Industrial, and Institutional Use
- Industry Standard 8" (203mm) Coaxial Loudspeaker
- Offers Proven Performance with Wide Frequency Response
- Post-Mounted Tweeter Adds Strength and a More Attractive Appearance
- Safety Listed to UL1480 and UL2043



Specifications

Speaker Type	Coaxial
Frequency Response	70Hz - 15.5kHz (±5dB)
Power Taps	.5, 1, 2, & 4 Watts
Sensitivity	98dB (peak), 95dB (avg)
Dispersion	120°
Depth	2 ⁷ / ₈ " (7.30 cm)
Diameter	8" (20.32 cm)
Safety Listing	UL1480 & UL2043

C803AT70

Features

- Ideal for Multi-Purpose Commercial, Industrial, and Institutional Use
- Industry Standard 8" (203mm) Coaxial, Loudspeaker
- Offers Proven Performance with Wide Frequency Response
- Post-Mounted Tweeter Adds Strength and a More Attractive Appearance
- Safety Listed to UL1480 and UL2043



Specifications

Speaker Type	Coaxial
Frequency Response	70Hz - 15.5kHz (±5dB)
Power Taps	.5, 1, 2, & 5 Watts
Sensitivity	98dB (peak), 95dB (avg)
Dispersion	120°
Depth	2 ⁷ / ₈ " (7.30 cm)
Diameter	8" (20.32 cm)
Safety Listing	UL1480 & UL2043

C803AT87

Features

- Ideal for Multi-Purpose Commercial, Industrial, and Institutional Use
- Industry Standard 8" (203mm) Coaxial, Loudspeaker
- Offers Proven Performance with Wide Frequency Response
- Post-Mounted Tweeter Adds Strength and a More Attractive Appearance
- Safety Listed to UL1480 and UL2043



Specifications

Speaker Type	Coaxial
Frequency Response	70Hz - 15.5kHz (±5dB)
Power Taps	1, 2, 4, & 8 Watts
Sensitivity	98dB (peak), 95dB (avg)
Dispersion	120°
Depth	2 ⁷ / ₈ " (7.30 cm)
Diameter	8" (20.32 cm)
Safety Listing	UL1480 & UL2043

C803AT72

Features

- Ideal for Multi-Purpose Commercial, Industrial, and Institutional Use
- Industry Standard 8" (203mm) Coaxial, Loudspeaker
- Offers Proven Performance with Wide Frequency Response
- Post-Mounted Tweeter Adds Strength and a More Attractive Appearance
- Safety Listed to UL1480 and UL2043



Specifications

Speaker Type	Coaxial
Frequency Response	70Hz - 15.5kHz (± 5 dB)
Power Taps	.25, .5, 1, 2, & 4 Watts
Sensitivity	98dB (peak), 95dB (avg)
Dispersion	120°
Depth	2 $\frac{7}{8}$ " (7.30 cm)
Diameter	8" (20.32 cm)
Safety Listing	UL1480 & UL2043

C803AT167

Features

- Ideal for Multi-Purpose Commercial, Industrial, and Institutional Use
- Industry Standard 8" (203mm) Coaxial, Loudspeaker
- Offers Proven Performance with Wide Frequency Response
- Post-Mounted Tweeter Adds Strength and a More Attractive Appearance



Specifications

Speaker Type	Coaxial
Frequency Response	70Hz - 15.5kHz (± 5 dB)
Power Taps	4, 8, & 16 Watts
Dispersion	120°
Sensitivity	98dB (peak), 95dB (avg)
Depth	5 $\frac{1}{8}$ " (13.03 cm)



Atlas Speakers Are Commonly Found In Office Complexes Of All Sizes

C10A

Features

- Acoustically Proven, General Purpose 25-Watt Loudspeaker
- Ideal for Multi-Purpose Commercial, Industrial and Institutional Use
- Mounts a Wide Selection of Atlas Sound Baffles



Specifications

Speaker Type	Dual Cone
Frequency Response	45Hz - 19kHz Nominal
Power Taps	8Ω, 25 Watts
Sensitivity	97dB Peak, 94dB Average
Dispersion	105°
Depth	2 7/8" (7.3025 cm)
Diameter	8" (20.32 cm)

C10AT25

Features

- Acoustically Proven, General Purpose Loudspeaker
- Ideal for Multi-Purpose Commercial, Industrial and Institutional Use
- Includes LT-25 Factory-Installed Line-Matching Transformer
- Mounts a Wide Selection of Atlas Sound Baffles



Specifications

Speaker Type	Treated Paper
Frequency Response	45Hz - 19kHz Nominal
Power Taps	.5, 1, 2, & 5 Watts
Sensitivity	97dB Peak, 94dB Average
Dispersion	105°
Depth	2 7/8" (7.3025 cm)
Diameter	8" (20.32 cm)



Atlas offers a variety of in ceiling speakers to meet the needs of all types of commercial facilities.

C5AT25

Features

- Ideal for Multi-Purpose Commercial, Industrial and Institutional Use
- Industry Standard Value Loudspeaker with Proven Performance
- Mounts a Wide Selection of Atlas Sound Baffles
- With Factory-Installed LT-25 Line-Matching Transformer



Specifications

Speaker Type	Treated Paper
Frequency Response	45Hz - 19kHz Nominal
Power Taps	.5, 1, 2, & 5 Watts
Sensitivity	96dB Peak, 93dB Average
Dispersion	105°
Depth	2 7/8" (6.6675 cm)
Diameter	8" (20.32 cm)

C10AT72

Features

- Acoustically Proven, General Purpose Loudspeaker
- Ideal for Multi-Purpose Commercial, Industrial and Institutional Use
- Includes LT-72 Factory-Installed Line-Matching Transformer
- Mounts a Wide Selection of Atlas Sound Baffles
- UL Certified, Safety Listed to UL1480 and UL2043



Specifications

Speaker Type	Treated Paper
Frequency Response	45Hz - 19kHz Nominal
Power Taps	.25, .5, 1, 2, & 4 Watts
Sensitivity	97dB Peak, 94dB Average
Dispersion	105°
Depth	2 7/8" (7.3025 cm)
Diameter	8" (20.32 cm)
Safety Listing	UL1480 & UL2043

C10AT70

Features

- Acoustically Proven, General Purpose Loudspeaker
- Ideal for Multi-Purpose Commercial, Industrial and Institutional Use
- Includes LT-70 Factory-Installed Line-Matching Transformer
- Mounts a Wide Selection of Atlas Sound Baffles



Specifications

Speaker Type	Treated Paper
Frequency Response	45Hz - 19kHz Nominal
Power Taps	.5, 1, 2, & 5 Watts
Sensitivity	97dB Peak, 94dB Average
Dispersion	105°
Depth	2 7/8" (7.3025 cm)
Diameter	8" (20.32 cm)

C5AT72

Features

- Ideal for Multi-Purpose Commercial, Industrial and Institutional Use
- Industry Standard Value Loudspeaker with Proven Performance
- Mounts a Wide Selection of Atlas Sound Baffles
- With Factory-Installed LT-72 Line-Matching Transformer
- Safety Listed to UL1480 and UL2043



Specifications

Speaker Type	Treated Paper
Frequency Response	45Hz - 19kHz Nominal
Power Taps	.5, 1, 2, & 4 Watts
Sensitivity	96dB Peak, 93dB Average
Dispersion	105°
Depth	2 7/8" (6.6675 cm)
Diameter	8" (20.32 cm)
Safety Listing	UL1480 & UL 2043

C5AT70

Features

- Ideal for Multi-Purpose Commercial, Industrial and Institutional Use
- Industry Standard Value Loudspeaker with Proven Performance
- Mounts a Wide Selection of Atlas Sound Baffles
- With Factory-Installed LT-70 Line-Matching Transformer



Specifications

Speaker Type	Treated Paper
Frequency Response	45Hz - 19kHz Nominal
Power Taps	.5, 1, 2, & 5 Watts
Sensitivity	96dB Peak, 93dB Average
Dispersion	105°
Depth	2 7/8" (6.6675 cm)
Diameter	8" (20.32 cm)



Atlas Sound coaxial drivers provide exceptional output and accurate high frequency reproduction for high ceiling and high power applications.

Coaxial Drivers

Applications

Atlas Sound coaxial drivers are optimized for high-ceiling applications such as arenas, convention centers, gymnasiums, theaters, airports, house of worship, shopping centers and auditoriums. The high efficiency of these speakers allows integrators to use lower tap settings resulting in less amplifier power used.

Features

- Compression Driver Versions Available
- 8 Ω and 70.7V Options Available
- Mounts a Wide Selection of Atlas Sound Baffles

General Description

Atlas Sound compression coaxial loudspeakers are optimized for high-ceiling applications such as arenas, convention centers, gymnasiums, and auditoriums. The extreme high efficiency and higher "Q" provide the increased available SPL often required in these high ceiling applications. Model 8CXT60 combines an 8" diameter, low frequency transducer and a 1" exit, true compression driver and model 12CXT60 combines a 12" diameter, low frequency transducer and a 1" exit, true compression driver. Both models feature a curvilinear, polypropylene cone for lower harmonic distortion, and a built-in crossover network for proper frequency transition between the two reproducers. Each unit includes a high efficiency factory installed 70.7V/100V transformer with power taps up to 60 watts. Model 12CX is a 12" compression driver that features an 8 Ω connection and is rated at 250 watts. All models are designed to work optimally in select Atlas Sound Q Series high volume enclosures allowing for a complete high output solution.

The cost effective 12" Atlas Sound C12BT60 coaxial loudspeaker complements 8CXT60, 12CX, and 12CXT60 compression drivers in high ceiling applications for full range music and voice reproduction. The C12BT60 combines a 12" low frequency driver and a 1" high frequency, post-mounted tweeter with a unique tweeter mounting plate to reduce phase cancellation from the woofer cone. A highly efficient passive crossover network is built in for proper frequency selection between the woofer and tweeter and both feature permanently aligned voice coils to assure distortion free performance. The C12BT60 includes a factory installed 70.7V transformer with power taps up to 60 watts as well as an 8 Ω bypass.



High Powered Speakers Are Often Necessary In Areas With High Ambient Noise Levels



8CXT60

Features

- 1" Exit Compression High Frequency Driver Coupled to a Specially Designed Conical Wave-Guide Horn Provides Exceptional Output & Accurate High Frequency Reproduction
- 90 Degree Conical Dispersion (2kHz Octave Band)
- Includes Factory Installed, 60W, 70.7/100V Transformer
- Perfectly Suited for Use with Atlas Sound "Q" Series Enclosures



Specifications

Speaker Type	Compression Driver Coaxial
Power Taps	7.5, 15, 30, & 60 Watts
Frequency Response	33Hz – 21kHz
Sensitivity (1W/1m)	92dB
Dispersion	90°
Depth	8¼" (20.96 cm)
Diameter	8" (20.32 cm)

12CX

Features

- 1" Exit Compression Driver Coupled to a Specially Designed Conical Wave-Guide Horn
- 90 Degree Conical Dispersion (2 kHz Octave Band)
- High Efficiency Cone Woofer is Optimally matched to the High Frequency Device Via a Specially Designed Crossover to Insure Even Transition
- Perfectly Suited for Use With Atlas Sound "Q" Series Enclosures

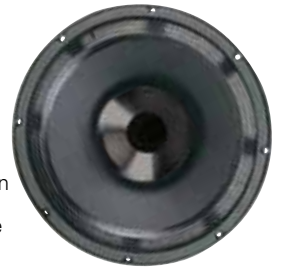

Specifications

Speaker Type	Compression Driver Coaxial
Power Taps	8Ω, 250 Watts
Frequency Response	65Hz – 15kHz
Sensitivity (1W/1m)	99dB
Dispersion	90°
Depth	8" (20.32 cm)
Diameter	12⅞" (32.70 cm)

12CXT60

Features

- 1" Exit Compression Driver Coupled to a Specially Designed Conical Wave-Guide Horn
- 90 Degree Conical Dispersion (2 kHz Octave Band)
- High Efficiency Cone Woofer Optimally Matched to High Frequency Device Via a Specially Designed Crossover to Insure Even Transition
- Perfectly Suited For Use with Atlas Sound "Q" Series Enclosures



Specifications

Speaker Type	Compression Driver Coaxial
Power Taps	7.5, 15, 30, & 60 Watts
Frequency Response	33Hz – 21kHz
Sensitivity (1W/1m)	99dB
Dispersion	90°
Depth	8" (20.32 cm)
Diameter	12⅞" (32.70 cm)

C12BT60

Features

- Coaxial Loudspeaker with 12" Diameter Low Frequency and 1" Diameter High Frequency Reproducer
- Includes Factory-Installed Line-Matching Transformer
- Mounts a Wide Selection of Atlas Sound Q Series Enclosures and Standard Baffles
- Professional Quality Sound Reproduction at a Competitive Price



Specifications

Speaker Type	Full Range Coaxial
Power Taps	7.5, 15, 30, & 60 Watts
Frequency Response	33Hz – 21kHz
Sensitivity (1W/1m)	95dB
Dispersion	90°
Depth	4¾" (10.64 cm)
Diameter	12⅞" (32.70 cm)



Atlas Sound GD and SD speakers and speaker packages are cost effective, complete solutions designed to save integrators and contractors labor and time during installation while still delivering high quality Atlas performance.

GD87



GD & SD Series Speakers

Applications

Atlas Sound GD and SD speakers and speaker packages utilize 8" drivers to deliver excellent coverage of public address and background music services in industrial, retail, transportation, and commercial applications.

Features

- Available With and Without Transformers
- Designed to Work With a Wide Variety of Atlas Sound Tile Bridges and Accessories

General Description

The Atlas Sound GD87 is a high performance coaxial loudspeaker that utilizes a post-mounted tweeter to add strength to the assembly and provide an attractive appearance. This coaxial loudspeaker features a frequency response of 45Hz-19kHz and a broad, uniform dispersion pattern of 105° (2kHz octave band). The GD87 combines a full-size 8" (203mm) diameter, low-frequency reproducer and a 3" (76mm) high-frequency reproducer coupled together via a built-in crossover network. The woofer has a 10oz. (260g) ceramic magnet and the tweeter has a 2.35 oz. (67g) ceramic magnet. The unit has an average sensitivity of 96dB (1W/1m).

The GD87 includes a factory installed high efficiency 8-watt 70.7V transformer constructed of audio grade laminations and has a full range frequency response of +1dB from 50Hz to 15kHz. The primary power taps are 1, 2, 4, and 8 watts. Model GD87W is a complete speaker and baffle solution that incorporates the GD87 speaker with the popular 62-8 baffle. Both the GD87 and GD87W are certified to safety listings UL1480 and UL2043.

The SD72 is a high-performance dual cone, 25 watt 8" (205mm) loudspeaker with a 10oz. (260g) ceramic magnet. It includes a curvilinear, treated paper cone for lower harmonic distortion. The loudspeaker is also equipped with a full 1" diameter copper voice coil with a black anodized aluminum former for better heat dissipation. Model SD72 operates within a frequency response range of 55Hz-8kHz (nominal) with a sensitivity of 97dB and a dispersion angle of 105°. Package includes factory installed 25/70.7V line matching transformer with tap selections ranging from .25 to 5 watts. The unit mounts a wide variety of Atlas Sound round and square baffles and enclosures to meet functional and aesthetic application requirements. The SD72 is also available in two package options, the SD72W and SD72WW. The SD72W includes the SD72 loudspeaker and a factory installed 62-8 CRS baffle that features concealed loudspeaker mounting studs. This baffle uses standard mounting holes allowing the SD72W to be used with the majority of Atlas Sound 8" tile bridges, mounting rings and enclosures. The SD72WW includes everything found in the SD72W package with the addition of a baffle mounted volume control knob for easy adjustment post installation. The SD72, SD72W, and SD72WW are all certified to safety listings UL1480 and UL2043.

The SD722W is an economical, 8" (205mm) loudspeaker package featuring a 5oz. (130g) ceramic magnet. It includes a curvilinear, treated paper cone for lower harmonic distortion. Model SD722W operates within a frequency response range of 55Hz-8kHz (nominal) with a sensitivity of 97dB and a dispersion angle of 105°. Package includes factory installed 25/70.7V line matching transformer with tap selections ranging from .25 to 2 watts. The SD722W includes a factory installed 62-8 CRS baffle that features concealed loudspeaker mounting studs. This baffle uses standard mounting holes allowing the SD722W to be used with the majority of Atlas Sound 8" tile bridges, mounting rings and enclosures.

Features

- Individually Packaged for Stocking & Ordering Convenience
- Industry Standard 8" (203mm) Coaxial Loudspeaker With High Quality Factory Installed Line Matching Transformer
- Offers Proven Performance With Wide Frequency Response
- Post-Mounted Tweeter Adds Strength and a More Attractive Appearance
- Safety Listed to UL1480 and UL2043.

Specifications

Speaker Type	Coaxial
Frequency Response	60Hz-15kHz
Power Taps	1, 2, 4, & 8 Watts
Sensitivity	96dB Average
Dispersion	105° (2kHz Octave Band, -6dB Points)
Depth	2 ⁷ / ₈ " (7.30 cm)
Diameter	8 ¹ / ₈ " (20.64 cm)
Safety Listing	UL1480 & UL2043



GD87W

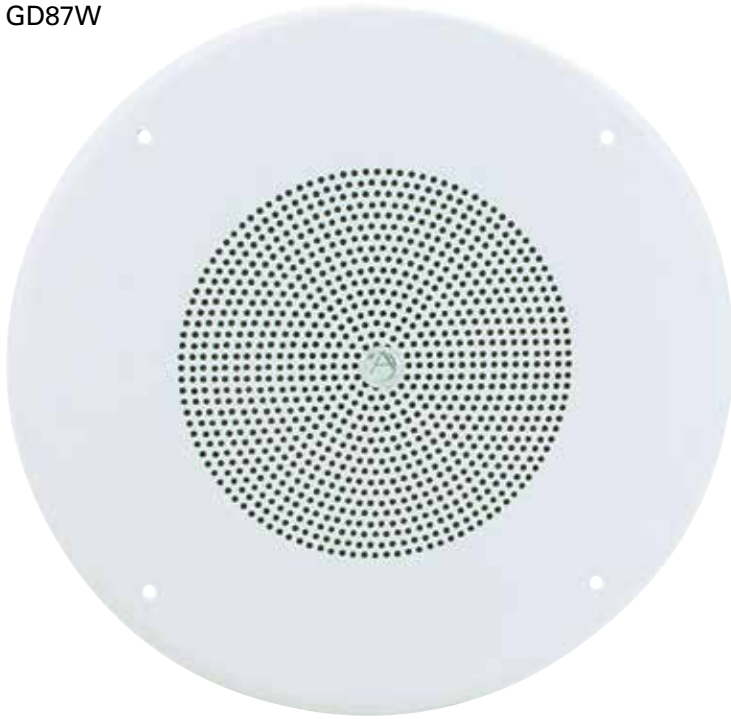

Features

- Individually Packaged for Stocking & Ordering Convenience
- Industry Standard 8" (203mm) Coaxial Loudspeaker With High Quality Factory Installed Line Matching Transformer and White CRS Baffle
- Offers Proven Performance With Wide Frequency Response
- Safety Listed to UL1480 and UL2043

Specifications

Speaker Type	Coaxial
Frequency Response	50Hz-15kHz (±7dB)
Power Taps	1, 2, 4, & 8 Watts
Sensitivity	96dB Average
Dispersion	105° (2kHz Octave Band, -6dB Points)
Depth	2 ⁷ / ₈ " (7.30 cm)
Diameter	12 ³ / ₄ " (20.64 cm)
Safety Listing	UL1480 & UL2043

GD87A

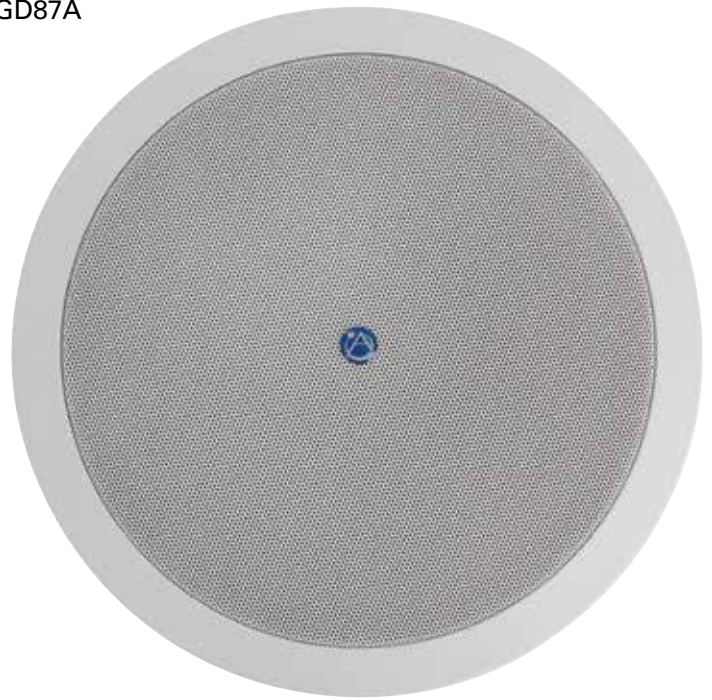

Features

- Industry Standard 8" (203mm) Coaxial Loudspeaker
- Easy Installation in Drop Tile or Sheetrock Ceilings via "Dog Leg" Mounting System (Included)
- Offers Proven Performance with Wide Frequency Response
- Ideal for Multi-Purpose Commercial, Industrial, and Institutional Use
- Attractive Press Fit Grille
- Quality 8 Watt 70.7V Transformer
- Does Not Work with Standard Enclosures or Tile Bridges

Specifications

Speaker Type	Coaxial
Frequency Response	55Hz – 15kHz (±7dB)
Power Taps	1, 2, 4, & 8 Watts
Sensitivity	96dB
Dispersion	105° (2kHz Octave Band, -6dB Points)
Depth	3 ¹ / ₂ " (87.63mm)
Diameter	10 ⁷ / ₁₆ " (272mm)

SD72



Features

- 5 Watt-Dual Voltage Transformer
- Individually Packaged for Stocking & Ordering Convenience
- Quality 10oz Dual Cone Speaker Provides Familiar Response & Performance
- Safety Listed to UL1480 and UL2043

Specifications

Speaker Type	Dual Cone
Frequency Response	55Hz-19kHz
Power Taps	.25, .5, 1, 2, & 5 Watts
Sensitivity	97dB Average
Dispersion	105° (2kHz Octave Band, -6dB Points)
Depth	2 ⁷ / ₈ " (7.30 cm)
Diameter	8 ¹ / ₈ " (20.64 cm)
Safety Listing	UL1480 & UL2043

SD72W



Features

- 10oz Dual Cone Speaker Provides Familiar Response & Performance
- Attractive CRS White Powder Coat Baffle
- Individually Packaged for Stocking & Ordering Convenience
- Quality 5 Watt-Dual Voltage Transformer
- Safety Listed to UL1480 and UL2043

Specifications

Speaker Type	Dual Cone
Frequency Response	55Hz-19kHz
Power Taps	.25, .5, 1, 2, & 5 Watts
Sensitivity	97dB Average
Dispersion	105° (2kHz Octave Band, -6dB Points)
Depth	2 ⁷ / ₈ " (7.30 cm)
Diameter	12 ³ / ₄ " (20.64 cm)
Safety Listing	UL1480 & UL2043

SD72WV



Features

- 10oz Speaker Provides Familiar Response & Performance
- Attractive CRS White Powder Coat Baffle with Center Mounted Volume Control
- Incorporate or Remove Volume Control Knob to Suit Application Requirements
- Individually Packaged for Stocking & Ordering Convenience
- Quality 5 Watt-Dual Voltage Transformer
- Safety Listed to UL1480 and UL2043

Specifications

Speaker Type	Dual Cone
Frequency Response	55Hz-19kHz
Power Taps	.25, .5, 1, 2, & 5 Watts
Sensitivity	97dB Average
Dispersion	105° (2kHz Octave Band, -6dB Points)
Depth	2 ⁷ / ₈ " (7.30 cm)
Diameter	12 ³ / ₄ " (20.64 cm)
Safety Listing	UL1480 & UL2043

SD722W



Features

- Voiced to Closely Match Frequency Response of Atlas C Series Drivers
- 25V/70.7V Operation with .25, .5, 1 & 2 watt Transformer Taps
- 62-8 Style White Grille Complements a Wide Variety of Atlas Enclosures and Mounting Options
- 6 Pack Master Carton Ordering Minimizes Construction Site Cardboard Waste
- 5 Oz Magnet

Specifications

Speaker Type	Dual Cone
Frequency Response	55Hz-19kHz
Power Taps	.25, .5, 1, and 2 Watts
Sensitivity	97dB Average
Dispersion	105° (2kHz Octave Band, -6dB Points)
Depth	2 ⁷ / ₈ " (7.3025 cm)
Diameter	12 ³ / ₄ " (20.6375 cm)



Atlas Sound preassembled speaker packages save installers and integrators time and money while still delivering the unmatched performance expected from Atlas.

4" & 8" Speaker Packages

Applications

Atlas Sound preassembled speaker packages deliver an excellent balance of performance and labor saving convenience. Available in multiple styles to meet the needs of any installation, these packages are ideal for use in retail, corporate, institutional, and industrial facilities for public address and background music applications.

Features

- Labor Saving Pre-Assembled Options
- Work with a Variety of Atlas Enclosures and Mounting Accessories
- Variety of Transformer and Grille Options



Paging Intelligibility In School Hallways Is A Must

General Description

The DLS4 is specially designed for use in low ceiling paging and background music applications such as airports where wide dispersion, high efficiency and ease of installation are required. The DLS4 is also well suited for use in rail stations, retail stores, and hospitality applications. The system consists of 4" high efficiency driver with a unique (patent pending) tap selector switch designed to allow for easy system tuning. A full selection of taps up to 8 watts as well as an 8Ω bypass setting is included for maximum system versatility. This switch "knob" also functions as a diffuser cone, providing smooth, even dispersion of the high frequency content from the center of the 4" driver.

Models incorporate the popular Atlas Sound FC104 high performance loudspeaker, recognized for full-range voice and music reproduction. Each unit provides wide-angle sound dispersion to achieve desired coverage with fewer loudspeakers in distributed systems. Each loudspeaker employs a 10-ounce ceramic magnet and a damped, high-compliance cone to provide excellent low-frequency reproduction with smooth extended response. Package includes factory-mounted, dual-voltage 25V/70.7V or 70.7V transformer and round or square grille with screw mount or torsionspring (T) installation. The EZB161-4 is equipped with the patented EZ-Mount support system. This model is designed for use in suspended ceiling tile installations that do not require a protective enclosure. Assemblies include pre-mounted EZ brackets, which are slotted to accept the provided EZ mount support rails. Rails attach with wing-nuts and adjust vertically to accommodate varying ceiling depth requirements (Note: No tile bridge is required). All B Series packages are shipped assembled and ready for installation.

Model D161-8 incorporates the 8" Atlas Sound C10A loudspeaker that includes a 10-ounce ceramic magnet and that handles 25-watts of power. Model G161-8 utilizes the 8" model C5A loudspeaker that includes a 5-ounce ceramic magnet and handles 15-watts. Both models feature a versatile 25V/70.7V transformer that includes pre-wired secondary leads with color-coded, stripped and tinned primary leads. Recessed grilles are offered in square versions with attractive white epoxy finish. To meet code requirements and facilitate installation in a wide variety of ceilings, Atlas Sound offers an optional selection of recessed and surface mounting enclosures, mounting rings and tile bridge accessories.

Model VP14MB is designed specifically for installations that may be targeted by vandals; the VP14 system from Atlas Sound provides highly intelligible speech reinforcement with the added benefit of extreme ruggedness. The VP14MB includes vandal resistant slanted wall mount baffle, finished in neutral beige, is ideal for use in high-security areas such as schools and correctional facilities. It's sturdy, 14-gauge baffle construction and specially designed protective labyrinth screen protects the enclosed speaker assembly against abuse. Each package contains a high-quality 8" diameter loudspeaker with a 10-ounce ceramic magnet and pre-assembled 25V/70.7V transformer with five power taps terminated to a euro block style connector. This connector includes 3 empty blocks to allow through connection of other devices such as call switches or intercom phones without the need for wire nuts.

FD and HD Series are cost-effective 8" dual-cone loudspeaker assemblies that deliver wide frequency response for general-purpose voice and music reproduction. FD series packages include the Atlas Sound C5A loudspeaker while the HD series packages feature the Atlas C10A loudspeaker. Units are shipped complete with grille and choice of 25V, 70.7V, or 25V/70.7V transformer factory wired to reduce field installation time and expense. FD Series models deliver up to 5 watts RMS based on the transformer and are available with two grille options. HD Series models have a deliver up to 5 watts RMS based on the transformer and are available with two grille options. Both styles will accept optional protective enclosures and mounting accessories to meet installation and code requirements.



DLS4

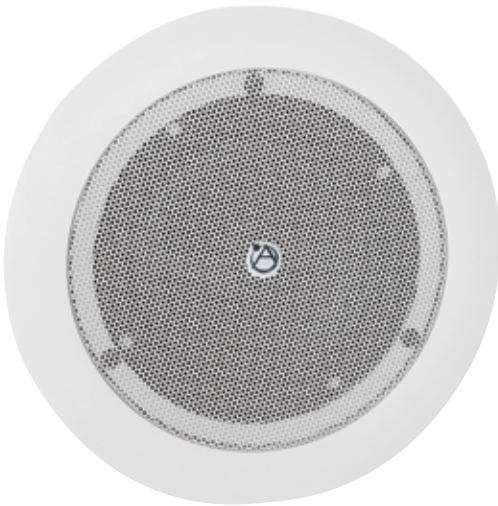

Features

- Selector Knob Doubles As a Dispersion Cone and Allows Tap Selection to Be Done After the Speaker is Installed Into Ceiling
- Small Footprint and Press-Fit Grilles Give Discrete Installed Appearance
- Works in Most New or Retro-Fit Ceiling Applications with Atlas Sound Hardware
- Safety Listed to UL1480

Specifications

Speaker Type	Paper
Power Taps	.5, 1, 2, 4, & 8 Watts
Frequency Response	150Hz – 17kHz
Dispersion	105°
Sensitivity	92dB
Depth	4¼" (10.8 cm)
Diameter	4" (10.16 cm)
Safety Listing	UL1480

EZHD72W



Features

- 62-8 Style Grill with White Finish
- Equipped with 25/70.7V Transformer
- Quick Assembly in Standard 2 x 4 Suspended Tile Ceilings

Specifications

Speaker Type	Treated Paper
Power Taps	.25, .5, 1, 2, & 5 Watts
Frequency Response	55Hz - 19kHz
Dispersion	105°
Sensitivity	97dB Peak, 94dB Average
Depth	2⅞" (7.30 cm)
Diameter	8" (20.32 cm)



In-Ceiling Paging Speakers Blend Into Any Location.

FD25W



Features

- Attractive White Finish
- Easy to Order Speaker/Transformer/Grill Assembly
- Mounts to Standard Tile Bridges, Enclosures, and Plaster Rings
- Suited for Any Commercial Paging or BGM Application
- 25V Transformer

Specifications

Speaker Type	Dual Cone
Power Taps	.5, 1, 2, & 5 Watts
Frequency Response	100Hz - 10kHz
Dispersion	105°
Sensitivity	97dB Peak, 94dB Average
Depth	2 ⁵ / ₈ " (6.67 cm)
Diameter	8" (20.32 cm)

FD70W



Features

- Attractive White Finish
- Easy to Order Speaker / Transformer / Grill Assembly
- Mounts to Standard Tile Bridges, Enclosures, and Plaster Rings
- Suited for Any Commercial Paging or BGM Application
- 70.7V Transformer

Specifications

Speaker Type	Dual Cone
Power Taps	.5, 1, 2, & 5 Watts
Frequency Response	100Hz - 10kHz
Dispersion	105°
Sensitivity	97dB Peak, 94dB Average
Depth	2 ⁵ / ₈ " (6.67 cm)
Diameter	8" (20.32 cm)

HD25W



Features

- Aluminum Contoured Baffle
- Attractive White Finish
- Easy to Order Speaker / Transformer / Grill Assembly
- Mounts to Standard Tile Bridges, Enclosures, and Plaster Rings
- Suited for Any Commercial Paging or BGM Application
- 25V Transformer

Specifications

Speaker Type	Dual Cone
Power Taps	.5, 1, 2, & 4 Watts
Frequency Response	50Hz - 18kHz
Dispersion	105°
Sensitivity	97dB Peak, 94dB Average
Depth	2 ⁵ / ₈ " (6.67 cm)
Diameter	8" (20.32 cm)

HD70W



Features

- Attractive White Finish
- Easy to Order Speaker / Transformer / Grill Assembly
- Suited for Any Commercial Paging or BGM Application
- 70.7V Transformer

Specifications

Speaker Type	Dual Cone
Power Taps	.5, 1, 2, & 5 Watts
Frequency Response	100Hz - 10kHz, ± 1.5dB
Dispersion	105°
Sensitivity	97dB Peak, 94dB Average
Depth	2 ⁷ / ₈ " (7.30 cm)
Diameter	8" (20.32 cm)

FD72W

Features

- Attractive White Finish
- Easy to Order Speaker / Transformer / Grill Assembly
- Mounts to Standard Tile Bridges, Enclosures, and Plaster Rings
- Suited for any Commercial Paging or BGM Application
- 25V / 70.7V Transformer



Specifications

Speaker Type	Dual Cone
Power Taps	.5, 1, 2, & 4 Watts
Frequency Response	100Hz - 10kHz, \pm 1.5dB
Dispersion	105°
Sensitivity	97dB Peak, 94dB Average
Depth	2 $\frac{5}{8}$ " (6.67 cm)
Diameter	8" (20.32 cm)

FD25M222W

Features

- Aluminum Contoured Baffle is Painted White
- Dual Cone Type Driver
- Factory-Assembled Loudspeaker Packages Reduce Installation Time and Expense
- 25V Transformer



Specifications

Speaker Type	Dual Cone
Power Taps	.5, 1, 2, & 5 Watts
Frequency Response	100Hz - 10kHz, \pm 1.5dB
Dispersion	105°
Sensitivity	97dB Peak, 94dB Average
Depth	2 $\frac{5}{8}$ " (6.67 cm)
Diameter	8" (20.32 cm)

HD72W

Features

- Attractive White Finish
- Easy to Order Speaker / Transformer / Grill Assembly
- Suited for Any Commercial Paging or BGM Application
- 25V / 70.7V Transformer



Specifications

Speaker Type	Dual Cone
Power Taps	.5, 1, 2, & 4 Watts
Frequency Response	100Hz - 10kHz, \pm 1.5dB
Dispersion	105°
Sensitivity	97dB Peak, 94dB Average
Depth	2 $\frac{7}{8}$ " (7.30 cm)
Diameter	8" (20.32 cm)

FD72M222W

Features

- 10 oz. Magnet Offers Lower Frequency Response
- Baffle is M222W Weather - Resistant Aluminum with White Finish
- Dual Cone Type Driver
- 25V / 70.7V Transformer



Specifications

Speaker Type	Dual Cone
Power Taps	.5, 1, 2, & 5 Watts
Frequency Response	100Hz - 10kHz, \pm 1.5dB
Dispersion	105°
Sensitivity	97dB Peak, 94dB Average
Depth	2 $\frac{7}{8}$ " (7.30 cm)
Diameter	8" (20.32 cm)

D161-8

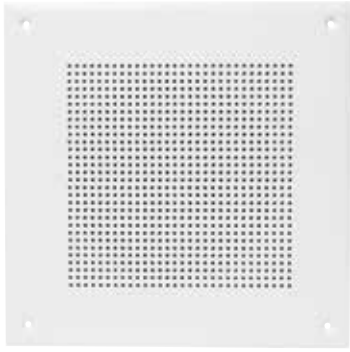

Features

- Save Time and Money with Factory-Assembled Loudspeaker, Transformer and Baffle Packages
- Dual Voltage, 4 Watt Transformer
- Standard Bolt Hole Pattern Matches a Variety of Plaster Rings, Tile Bridges, & Enclosures
- Tap Selection Codes on Transformer Make Installation Easy

Specifications

Speaker Type	Dual Cone
Power Taps	.5, 1, 2, & 4 Watts
Frequency Response	100 Hz - 10 kHz
Dispersion	105°
Sensitivity	97dB
Depth	2 $\frac{7}{8}$ " (7.30 cm)
Diameter	8" (20.32 cm)

G161-8



Features

- 161-8 Grill Mounts to Several Recessed and Surface Mount Enclosures
- Dual Voltage Transformer
- 8" Speaker with Wizzer Cone and 5oz. Magnet
- Factory-Assembled Loudspeaker Packages Reduce Installation Time and Expense
- Packaged in Individual Boxes that Include Both Hardware Bag and Installation Instructions
- Standard Bolt Hole Pattern Matches a Variety of Plaster Rings, Tile Bridges, & Enclosures
- Tap Selection Codes on Transformer Make Installation Easy

Specifications

Speaker Type	Dual Cone
Power Taps	.5, 1, 2, & 4 Watts
Frequency Response	100Hz - 10kHz
Dispersion	105°
Sensitivity	96dB
Depth	2 $\frac{5}{8}$ " (6.67 cm)
Diameter	8" (20.32 cm)

B51-4



Features

- Attractive White Finish
- Easy to order 4" Speaker/Transformer/Grill Assembly
- Suited for Any Commercial Paging or BGM Application

Specifications

Speaker Type	Treated Paper
Power Taps	.5, 1, 2, & 4 Watts
Frequency Response	100Hz - 10kHz
Dispersion	135°/ -6dB, 2kHz
Sensitivity	94dB
Depth	2 $\frac{1}{4}$ " (5.72 cm)
Diameter	4" (10.16 cm)

B161-4

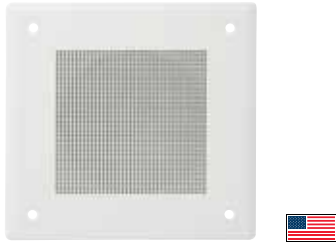

Features

- Factory-Assembled Loudspeaker Packages Save Time and Money
- High Compliance 4" Loudspeaker for Full-Range Audio Reproduction in Background Music and Paging Systems

Specifications

Speaker Type	FC104
Power Taps	.5, 1, 2, & 4 Watts
Frequency Response	100Hz - 10kHz (± 1.5 dB)
Dispersion	135°/ -6dB, 2kHz
Sensitivity	94dB
Depth	2¼" (5.72 cm)
Diameter	4" (10.16 cm)

EZB161-4



Features

- Factory-Assembled Loudspeaker Packages Save Time and Money
- High Compliance 4" Loudspeaker for Full-Range Audio Reproduction in Background Music and Paging Systems

Specifications

Speaker Type	FC104
Power Taps	.5, 1, 2, & 4 Watts
Frequency Response	100Hz - 10kHz (± 1.5 dB)
Dispersion	135°/ -6dB, 2kHz
Sensitivity	94dB
Depth	2¼" (5.72 cm)
Diameter	4" (10.16 cm)

BT720-4



Features

- Attractive White Finish
- Easy to Order Speaker/Transformer/Grill Assembly
- Suited for Any Commercial Paging or BGM Application

Specifications

Speaker Type	FC104
Power Taps	.25, .5, 1, 2, & 5 Watts
Frequency Response	100Hz - 10kHz (± 1.5 dB)
Dispersion	135°/ -6dB, 2kHz
Sensitivity	94dB
Depth	2¼" (5.72 cm)
Diameter	4" (10.16 cm)

BT720-4-T47



Features

- Easy-To-Install Torsion Spring Grille
- Factory-Assembled Loudspeaker Packages Save Time and Money
- High Compliance 4" Loudspeaker for Full-Range Audio Reproduction in Background Music and Paging Systems

Specifications

Speaker Type	FC104
Power Taps	.25, .5, 1, 2, & 5 Watts
Frequency Response	60Hz - 12kHz (± 1 dB)
Dispersion	130°/ -6dB, 2kHz
Sensitivity	88dB (1W, 1M)
Depth	2¼" (5.72 cm)
Diameter	4" (10.16 cm)



Atlas Sound surface mount speakers are designed to provide high performance audio in any application in combination with ease of install and long term enjoyability.

Surface Mount Speaker Systems

Applications

Use Atlas Sound's SM Series surface mount loudspeakers where versatility and high fidelity sound are desired in commercial, professional, and residential applications. These systems are ideal in monaural and stereo foreground or background music systems; video systems in conference rooms & classrooms, retail stores, restaurants, recreation/sports centers, houses of worship, and more.

Features

- 70.7V and/or 8Ω Operation
- Available in Black (-B) or White (-WH)
- Powder Coated Steel Grilles
- Five-Year Warranty

General Description

The Atlas Sound SM8CXT and SM12CXT are 8" and 12" high efficiency speakers designed for indoor applications. Each model features an Atlas compression driver coaxial speaker, 8CXT60/12CXT60 that provides a 90° conical coverage pattern and features a barrier strip transformer that offers 70.7V/100V or 8Ω functionality as well as a parallel Speak-On™ input for 8Ω only use, allowing them to be used with many different equipment styles and in many applications. Each unit includes integrated ¼"-20 insert fly points or an optional wall bracket is available for mounting. Each model includes fuse protection for both low and high frequencies ensuring long lasting performance.

The SM8SUB70 and SM12SUB70 surface mount subwoofers are designed to reinforce the performance of the SM8CXT and SM12CXT with extended, low frequency production. These models feature an internal high efficiency 70.7V/100V transformer that delivers up to 60 watts of power at 70.7V/100V and that includes a bypass for 8Ω operation. Additionally the unit includes a parallel Speak-On™ input for 8Ω only use. These units can also be flown or wall mounted with the optional bracket that is available. The driver has a fuse that ensures the unit's performance against misuse or abuse.

The SM Series also includes three weather resistant, indoor/outdoor models, the SM42T, SM52T, and SM82T. These models feature Atlas Sound TRX WAVEGUIDE™ technology, a mathematically conceived, advanced design of the high frequency director to optimize vocal and musical clarity. The constant directivity technology provides smooth, accurate, and even sound coverage in both vertical and horizontal mounting positions. Each unit is constructed using UV-resistant, talc impregnated, polypropylene injection molded cabinets; polypropylene ortreated woofer cones; powder coated steel grilles and all brass hardware. Each model has been evaluated for weather resistance by undergoing a stringent 100-hour salt spray test per the ASTM B117 standard. Each unit includes a 70.7V/100V line-matching transformer with adjustable power tap selector and an 8Ω bypass for direct-coupled operation. Input is via a convenient 2-pole binding post capable of accommodating two 14-gauge stranded wires.

SM42T



Features

- 1" Ferrofluid™ Cooled Dome Tweeter & Highly Efficient 4" Polypropylene Woofer
- Conforms to 100HR Salt Spray Test Per ASTM B117
- All ¼"-20 Hardware Inserts Allow Easy Integration of "Off The Shelf" Security Hardware
- Atlas Sound POLYGUARD™ High Frequency Protection Circuit
- TRX WAVEGUIDE™- Constant Directivity Style High Frequency Wave Guide System
- Available in Black or White
- Color Matched Heavy-duty Zinc Chromate Plated & Powder Coated "C" Bracket (Included)
- Screwdriver Adjustable 16-Watt 70.7V/100V Transformer (may be bypassed for 8Ω operation)
- Adaptive Technologies Multimount Compatible
- Five-Year Warranty

Specifications

Speaker Type	Surface Mount
Power Taps	2, 4, 8, 16 Watts & 8Ω Bypass
Frequency Response	115Hz – 16kHz
Dispersion	90°H x 90°V
Sensitivity	88dB
Height	7" (17.78 cm)
Width	5" (12.7 cm)
Depth	5 ¹⁵ / ₁₆ " (15 cm)



SM52T



Features

- 1" Ferrofluid™ Cooled Dome Tweeter
- Conforms to 100HR Salt Spray Test Per ASTM B117
- All ¼"-20 Hardware Inserts Allow Easy Integration of "Off The Shelf" Security Hardware
- Atlas Sound POLYGUARD™ High Frequency Circuit Diverts Damaging Transient Signals to Protect the Tweeter
- Atlas Sound TRX WAVEGUIDE™- A Constant Directivity Style High Frequency Wave Guide System Provides Accurate, Even High Frequency Coverage
- Available in Black or White
- Color Matched Heavy-duty Zinc Chromate Plated & Powder Coated "C" Bracket (Included)
- Compact, Two-Way Loudspeaker Systems for Exceptional Performance in Sound Reinforcement Systems
- Highly Efficient 5¼" Polypropylene Woofer
- Screwdriver Adjustable 30-Watt 70.7V/100V Transformer for Distributed Sound Applications and an 8Ω bypass
- Adaptive Technologies Multimount Compatible
- Five-Year Warranty

Specifications

Speaker Type	Surface Mount
Power Taps	.94, 1.9, 3.7, 7.5, 15, 30 Watts & 8Ω bypass
Frequency Response	95Hz – 20kHz
Dispersion	90°H x 90°V
Sensitivity	89dB
Height	10½" (25.87 cm)
Width	6⅞" (17.46 cm)
Depth	5⅞" (14.92 cm)

SM82T



Features

- 1" Exit Titanium High Frequency Compression Driver
- Conforms to 100HR Salt Spray Test Per ASTM B117
- All ¼"-20 Hardware Inserts Allow Easy Integration of "Off-The-Shelf" Security Hardware
- POLYGUARD™ High Frequency Circuit Diverts Damaging Transient Signals to Protect the Tweeter
- Atlas Sound TRX WAVEGUIDE™- A Constant Directivity Style High Frequency Wave Guide System Provides Accurate, Even High Frequency Coverage
- Available in Black or White
- Color Matched Heavy-Duty Zinc Chromate Plated and Powder Coated "C" Bracket (Included)
- Compact, 2-Way Loudspeaker Systems For Exceptional Performance In Music and Sound Reinforcement Systems
- Highly Efficient 8" HYCONET Treated Woofer
- Screwdriver Adjustable 60 Watt 70.7V/100V Transformer for Distributed Sound Applications with 8Ω Bypass
- Adaptive Technologies Multimount Compatible
- Five-Year Warranty

Specifications

Speaker Type	Surface Mount
Power Taps	1.9, 3.8, 7.5, 15, 30, 60 Watts & 8Ω bypass
Frequency Response	65Hz – 20kHz
Dispersion	65°H x 65°V
Sensitivity	92dB
Height	16½" (41.91 cm)
Width	9⅞" (23.02 cm)
Depth	8⅞" (21.4 cm)

SM8CXT



Features

- Multiple ¼"-20 Inserts, Providing Fly Points for a variety of Mounting Configurations
- Includes Internal, High Efficiency 60 Watt 70.7V/100V Transformer (May Be Bypassed For 8Ω Operation)
- Barrier Strip Input for 70.7V/100V/8Ω or Parallel 4 Pole Speak-On Input For 8Ω Operation Only
- Unique Input Panel Allows Use of Standard 4" Square Box Cover (Raco 753 or eq.) for Applications Where Flex Conduit is Required for Termination
- Durable Black or White, Rough-Coat Finish
- Fuse protection for Low and High Frequency Drivers
- Optional Brackets for Wall Mounting
- High Performance Atlas Sound Compression Driver Coaxial Loudspeakers in Versatile, Flyable, Wood Enclosure
- Attractive, Heavy-Duty Grille Assembly

Specifications

Speaker Type	8CX
Power Taps	7.5, 15, 30, 60 Watts & 8Ω
Frequency Response	60Hz – 15 kHz
Sensitivity	92dB
Dispersion	90°
Height	15½" (39.37 cm)
Width	10⅝" (27 cm)
Depth	10⅝" (26.35 cm)

SM12CXT



Features

- Multiple ¼"-20 Inserts, Providing Fly Points for a variety of Mounting Configurations
- Includes Internal, High Efficiency 60 Watt 70.7V/100V Transformer (May Be Bypassed For 8Ω Operation)
- Barrier Strip Input for 70.7V/100V/8Ω or Parallel 4 Pole Speak-On Input For 8Ω Operation Only
- Unique Input Panel Allows Use of Standard 4" Square Box Cover (Raco 753 or eq.) for Applications Where Flex Conduit is Required for Termination
- Durable Black or White, Rough-Coat Finish
- Fuse protection for Low and High Frequency Drivers
- Optional Brackets for Wall Mounting
- High Performance Atlas Sound Compression Driver Coaxial Loudspeakers in Versatile, Flyable, Wood Enclosure
- Attractive, Heavy-Duty Grille Assembly

Specifications

Speaker Type	12CX
Power Taps	7.5, 15, 30, 60 Watts & 8Ω
Frequency Response	55Hz – 15kHz
Sensitivity	99dB
Dispersion	90°
Height	19" (48.26 cm)
Width	14½" (36.83 cm)
Depth	14⅞" (35.72 cm)

SM8SUB70



Features

- Multiple ¼"-20 Inserts, Providing Fly Points for a Variety of Mounting Configurations
- Includes Internal High Efficiency 60 Watt 70.7V/100V Transformer (May Be Bypassed For 8Ω Operation)
- Barrier Strip Input for 70.7V/100V/8Ω or Parallel 4 pole Speak-On™ Input For 8Ω Operation Only
- Unique Input Panel Allows Use of Standard 4" Square Box Cover (Raco 753 or eq.) for Applications Where Flex Conduit is Required for Termination
- Durable Black or White, Rough-Coat Finish
- Optional Bracket For Wall Mounting
- Attractive, Heavy-Duty Grille Assembly

Specifications

Speaker Type	8" Paper Cone
Power Taps	7.5, 15, 30, 60 Watts & 8Ω
Frequency Response	55Hz – 150Hz
Sensitivity	87dB
Dispersion	Omni
Height	15½" (39.37 cm)
Width	10⅝" (27 cm)
Depth	10⅝" (26.35 cm)

SM12SUB70



Features

- Multiple ¼"-20 Inserts, Provide Fly Points for a Variety of Mounting Configurations
- Includes Internal, High Efficiency, 60 Watt 70.7V/100V Transformer (May Be Bypassed for 8Ω Operation)
- Barrier Strip Input for 70.7V/100V/8Ω or Parallel 4 Pole Speak-On Input (8Ω Only)
- Unique Input Panel Allows Use of Standard 4" Square Box Cover for Applications Where Flex Conduit is Required for Termination.
- Durable Black or White, Rough-Coat Finish
- Optional Bracket for Wall Mounting
- Attractive, Heavy-Duty Grille Assembly

Specifications

Speaker Type	12" Paper Cone
Power Taps	7.5, 15, 30, 60 Watts & 8Ω
Frequency Response	45Hz – 125Hz
Sensitivity	89dB
Dispersion	Omni
Height	19" (48.3 cm)
Width	14½" (36.8 cm)
Depth	14⅞" (35.7 cm)

VP14MB



Features

- Attractive Design is Suitable for Use in a Variety of Surface-Mount Vandal Proof Applications
- Beige Finish
- Durable All-steel Construction
- Impermeable Security Grille Protects Speaker

Specifications

Speaker Type	8" Full Range
Power Taps	.25, .5, 1, 2, & 4 Watts
Frequency Response	50Hz - 15kHz
Sensitivity	96dB
Dispersion	105°
Height	11 ⁷ / ₁₆ " (29.05 cm)
Width	11 ³ / ₄ " (29.82 cm)
Depth	3 ¹ / ₄ " (8.26 cm)

VP14ENC



Features

- 9.5° Sloped Design Offers Directional Sound Projection
- Attractive Design is Suitable for Use in a Variety of Surface-Mount Vandal Proof Applications
- Beige Finish
- Durable All-steel Construction
- Wiremold™ 500 & 700 Series Compatible

Specifications

Height	11 ⁷ / ₁₆ " (29.05 cm)
Width	11 ³ / ₄ " (29.82 cm)
Depth	5 ⁵ / ₁₆ " (13.5 cm)

SMBS



Features

- Convenient Lead Wire Extensions Assure Expedited Field Connection
- Durable White Powder Coat Finish
- Easy-To-Install Loudspeaker Package Includes Provisions for Fast Clamp-Mount Installation to I-Beams and Girders
- Package Includes an 8" Dual-Cone Loudspeaker with a Pre-Mounted Transformer, Baffle and Enclosure Equipped with Clamp Mounts
- Safety Listed to UL1480

Specifications

Speaker Type	C10A
Power Taps	.25, .5, 1, 2, & 4 Watts
Frequency Response	85Hz - 20kHz
Dispersion	105°
Sensitivity	92dB
Height	11 ¹ / ₂ " (29.21 cm)
Width	11 ¹ / ₂ " (29.21 cm)
Depth	5 ¹ / ₂ " (13.97 cm)
Safety Listing	UL1480

WD417-25



Features

- 9.5° Sloped Design Offers Directional Sound Projection
- Attractive Design is Suitable for Use in a Variety of Surface-Mount Applications
- Includes High-Quality 8" Loudspeaker with 25V Line Transformer

Specifications

Power Taps	.5, 1, 2, & 4 Watts
Height	10½" (26.67 cm)
Width	9½" (24.13 cm)
Depth	5½" (13.97 cm)

WD417-72



Features

- 9.5° Sloped Design Offers Directional Sound Projection
- Attractive Design is Suitable for Use in a Variety of Surface-Mount Applications
- Includes High-Quality 8" Loudspeaker with Dual Voltage Line Transformer

Specifications

Power Taps	.5, 1, 2, & 4 Watts
Height	10½" (26.67 cm)
Width	9½" (24.13 cm)
Depth	5½" (13.97 cm)

WD417-72V



Features

- 9.5° Sloped Design Offers Directional Sound Projection
- Attractive Design is Suitable for Use in a Variety of Surface-Mount Applications
- Includes High-Quality 8" Loudspeaker with Dual Voltage Line Transformer
- Knob /Screwdriver-Adjust Volume Control

Specifications

Power Taps	.5, 1, 2, & 4 Watts
Height	10½" (26.67 cm)
Width	9½" (24.13 cm)
Depth	5½" (13.97 cm)



Surface Mount Speakers Are Easily Integrated Into Conference And Board Room Applications.



The PM Series from Atlas Sound provides the clean and popular look of drop speakers for restaurants, bars, retail shops, and other modern design commercial installations with the same high fidelity reproduction and performance levels of other Atlas Sound speaker designs.

Pendant Mount Speaker Systems

Applications

The PM Series from Atlas Sound provides the clean and popular look of drop speakers for restaurants, bars, retail shops, and other modern design commercial installations with the same high fidelity reproduction and performance levels of other Atlas Sound speaker designs.

Features

- Input Terminal Connection with 70.7V Transformer and 8Ω Bypass
- Easily Installed Via Included Suspended Cable Mounting
- Enclosure Can Be Mounted Using Standard 3/4" Ceiling Fan Mount Hardware
- Top Cover Blends with Enclosure to Conceal Interconnect
- Available in Black (-B) or White (-WH)

General Description

The PM4FA and PM8FA pendent mount speakers are 4" and 8" speakers that utilize the Strategy Series® FA series drivers, FA134 and FA138. Both models are ideal for music and paging applications. These drivers are mounted in specifically tuned and ported enclosures allowing for upscale performance in retail and hospitality BGM applications where intelligibility is critical. The PM4FA includes 70.7V power taps up to 16 watts and the PM8FA includes 70.7V power taps up to 60 watts.

The PM8GD system includes the economical 8" GD87 coaxial driver for installations when high-density speaker counts are required to provide accurate response and high efficiency. The PM8GD provides 120° dispersion in the vocal frequency range making it ideal for page only applications. The PM8GD includes 70.7V power taps up to 8 watts but offers extreme efficiency, up to 96dB at 1W/1m, enabling an installer to use lower tap settings and more loudspeakers per amp channel without losing intelligibility.

The PM8CX uses the Atlas Sound 8CXT60 coaxial compression driver and is designed for applications with high ceilings, up to 30 feet. This speaker is capable of producing 96db at 1W/1m with a 90° conical coverage pattern making them the ideal solution for lobbies, museums, airports, transit hubs, entryways, and porticos. The PM8CX includes 70.7V power taps up to 60 watts.

Atlas additionally offers a pendent mount subwoofer, PM8SUB, designed to compliment systems using other Atlas PM series full range speakers. Each model includes an 8", 150-watt subwoofer that offers excellent low frequency reproduction in the same sealed, pendent mount chassis found in other PM series speakers. Both PM8SUB models include an integrated 70.7V transformer that includes power taps up to 60-watts with an 8Ω bypass option.

PM4FA



Features

- 4" FA134 Driver Provides 130° (65° Off-Axis) Coverage in The 2kHz Octave Band
- 3 Meters of 2mm Cable & Mounting Hardware Included
- Compatible with Standard 3/4" Ceiling Fan Hardware
- Discreet, Attractive Enclosure
- Available in Black (-B) or White (-WH)

Specifications

Speaker Type	FA134
Power Taps	1, 2, 4, 8, 16 Watts & 8Ω
Sensitivity	88dB Average
Dispersion	130°
Height	13 7/8" (35.23 cm)
Diameter	9 1/4" (23.5 cm)

PM8FA

Features

- 8" FA138 Driver Provides 100° (50° Off-Axis) Coverage in the 2kHz Octave Band
- 3 Meters of 2mm Cable & Mounting Hardware Included
- Compatible with Standard 3/4" Ceiling Fan Hardware
- Available in Black (-B) or White (-WH)

Specifications

Power Taps	1.9, 3.8, 7.5, 15, 30, 60 Watts & 8Ω
Sensitivity	90dB Average
Dispersion	100°
Height	16 5/8" (42.21 cm)
Diameter	12 1/4" (31.12 cm)



PM8GD



Features

- 8" GD87 Driver Provides 120° (60° Off-Axis) Coverage in the 2kHz Octave Band
- 3 Meters of 2mm Cable & Mounting Hardware Included
- Compatible with Standard ¾" Ceiling Fan Hardware
- Extreme High Efficiency (96dB 1W/1m) Allows for Lower Tap Settings and More Loudspeakers Per Amp Channel in Many Installations
- Available in Black (-B) or White (-WH)

Specifications

Speaker Type	GD87
Power Taps	1, 2, 4, 8 Watts & 8Ω
Sensitivity	96dB Average
Dispersion	105° (2kHz Octave Band, -6dB Points)
Height	16⅝" (42.21 cm)
Diameter	12¼" (31.12 cm)

PM8CX



Features

- Direct Input Via Concealed Terminal Block
- 8" 8CXT60 Driver Provides 90°(45° Off-Axis) Coverage in the 2kHz Octave Band
- 3 Meters of 2mm Cable & Mounting Hardware Included
- Compatible with Standard ¾" Ceiling Fan Hardware
- The Best Solution for High Ceiling Applications
- Available in Black (-B) or White (-WH)

Specifications

Speaker Type	8CXT
Power Taps	7.5, 15, 30, 60 Watts & 8Ω
Sensitivity	92dB Average
Dispersion	90°
Height	16⅝" (42.21 cm)
Diameter	12¼" (31.12 cm)

PM8SUB



Features

- 3 Meters of 2mm Cable & Mounting Hardware Included
- Compatible with Standard ¾" Ceiling Fan Hardware
- Ideal Low Frequency Driver for High Ceiling Applications
- 150 Watts RMS Power at 8Ω
- Available in Black (-B) or White (-WH)

Specifications

Speaker Type	8" Paper Cone
Power Taps	7.5, 15, 30, 60 Watts & 8Ω
Dispersion	Omni
Sensitivity	92dB Average
Height	16⅝" (42.21 cm)
Diameter	12¼" (31.12 cm)



Atlas Sound landscape speakers are designed to provide premium sound for paging and BGM applications while seamlessly blending into the environment.

Landscape Speaker Systems

Applications

Atlas landscape speakers are designed to withstand the harshest weather conditions while maintaining their high performance levels. These speakers deliver exceptional intelligibility in paging and BGM applications for business complexes, amusement parks, hotels, research facilities, higher education campuses, or any architecturally landscaped area.

Features

- Weather Resistant Construction
- Designed to Blend Into Landscape
- 70.7V/100V Transformers with 8Ω Bypass Capability

General Description

The GSS-G and GST-G are garden speakers designed to blend into their surroundings in landscaped areas. These speakers feature a two-piece design that allows for a two-phase installation. The speaker section is the same for both models. Inside the enclosure is a durable 8" coaxial speaker that offers a 360-degree horizontal dispersion pattern. The GSS-G includes a short base for surface mounting and the GST-G includes a deep base for in-landscape burial. After the base is installed in phase one and construction is completed the system contractor can return to install the speaker/transformer. This multiple step process protects the speakers from being damaged during the construction/landscaping process and also eliminates the potential for theft from the construction site. The speaker bases have a protective cover to keep debris out during construction. Both the speaker enclosure and base units are made of stable polyethylene, which ensures performance in even the most temperamental and unpredictable climates.

The ROCKFA62T-BR utilizes the Strategy Series® FA136 driver in a specially designed, natural looking brown enclosure designed to mimic the look of granite. The speaker includes a highly efficient 6" woofer section and ½" PEI dome high frequency tweeter. An internal 32-watt 70.7V/100V transformer is terminated to a 24" direct burial rated pigtail that includes conductors for all transformer taps including a 1:1 connection for 8Ω operation. To withstand the harshest environments, the ROCKFA62T-BR is constructed using weather-resistant materials including Kevlar® treated woofer cones and synthetic rubber. The speaker systems include an embedded underground eyebolt for a security anchor to prevent theft once installed.



Atlas Landscape Speakers Are Designed To Seamlessly Blend Into Any Architectural Landscape Design



GSS-G



Features

- Down Firing Speaker Cannot Collect Dust or Condensation and is Protected by Triple Layer Grille Assembly
- Durable 8" Coaxial Speakers with a 360° Horizontal Dispersion Pattern
- Revolutionary Two-Piece design Allows for Two-Phase Installation
- Shallow Base for Surface or Shallow Bed Mounting

Specifications

Speaker Type	Surface Mount
Power Taps	8, 16, 32 Watts & 8Ω Bypass
Frequency Response	43Hz – 20kHz (±7dB)
Dispersion	360°H x 50°V
Depth	17 ⁵ / ₈ " (44.77 cm)
Diameter	15 ¹ / ₈ " (38.42 cm)

GST-G



Features

- Down Firing Speaker Cannot Collect Dust or Condensation and is protected by Triple Layer Grille Assembly
- Durable 8" Coaxial Speakers with a 360° Horizontal Dispersion Pattern
- Revolutionary Two-Piece Design Allows for Two-Phase Installation
- Deep Base for Landscape Installations

Specifications

Speaker Type	Inground
Power Taps	8, 16, 32 Watts & 8Ω Bypass
Frequency Response	43Hz – 20kHz (±7dB)
Dispersion	360°H x 50°V
Depth	20 ⁷ / ₈ " (53.02 cm)
Diameter	17 ⁷ / ₈ " (44.13 cm)

ROCKFA62T-BR



Features

- Available in a Brown Finish
- Durable 6" Coaxial Speakers with a 110-Degree Horizontal Dispersion Pattern
- Kevlar® Treated Woofers Cone with Synthetic Rubber Surround
- Includes an Embedded Underground Eye Bolt for a Security Anchor to Prevent Theft

Specifications

Power Rating	50 Watts
Transformer Taps	4, 8, 16, 32 Watts & 8Ω Bypass
Sensitivity	88dB
Frequency Response	80Hz - 20kHz (±5dB)
Dispersion	110°
Height	10.5" (26.7 cm)
Width	12.5" (31.8 cm)
Depth	9" (22.9 cm)



Atlas Sound offers a variety of high quality, line-matching transformers that can be used with a wide variety of Atlas speaker types and sizes allowing almost any speaker to be used in a low voltage system.



Choosing The Right Transformer Is Critical To Ensuring Proper Volume In A Give Space.

Transformers

Applications

Atlas Sound makes several models of low voltage transformers that can be used with 25V, 70.7V, and 100V systems. These transformers can easily mount near a speaker giving integrators the ability to use almost any speaker in a commercial application. Additionally Atlas offers many of its speaker models with a pre-installed transformer for integrator convenience.

Features

- Constructed with Audio Grade Laminations
- Multiple Power Taps Available on Each Model
- Color Coded Wiring Allows for Easy Installation

General Description

The largest transformer that Atlas offers is the AF140 single coil autoformer. This unit includes multiple taps for maximum flexibility in matching a wide variety of loudspeaker loads to power amplifier outputs. A single AF140 will handle loads up to 150 watts and by connecting two units in series; power-handling capacity can be increased to 300 watts.

Model HT327 offers high power handling with minimal insertion loss and wide frequency response providing quality line matching of loudspeakers in high output power systems. The unit is constructed of audio grade laminations and offers primary taps at 8, 16, and 32 Watts with secondary impedance of 4Ω and 8Ω. Insertion loss does not exceed 0.6dB and operates within a frequency range of +1dB from 30Hz to 15kHz. The transformer is designed for external mounting to surfaces other than the loudspeaker.

The HT167 is a high quality line-matching transformer with 0.6dB insertion loss assuring efficient loudspeaker matching in distributed 70.7V systems. Unit is constructed of audio grade laminations and has primary taps at 4, 8, and 16 Watts. The secondary impedance is 4Ω and 8Ω and the frequency response is +1dB from 40Hz to 15kHz. Atlas offers the CX188329 mounting bracket for the HT167. This mounting bracket allows the HT167 to be attached to standard mounting holes on 8" loudspeaker baskets like the C5A, C10A, and C803A.

The HT-87 is a high-efficiency transformer designed for 70.7V systems that have a maximum insertion loss of 0.6dB for application in distributed sound systems. Units are constructed of audio grade laminations and have a full range frequency response of +1dB from 50Hz to 15kHz. The primary taps are 1, 2, 4, and 8 watts with secondary impedance taps at 4Ω and 8Ω.

Models HT-47 and HT-42 are industry standard, high quality transformers with audio grade laminations offering low insertion loss and full-range frequency response. Model HT-47 is designed for use in 70.7V applications and model HT-42 is designed for use in 25V systems. Insertion loss will not exceed 1.0dB for either model and the frequency response is +1dB from 60Hz to 12kHz. Primary taps are .5, 1, 2, and 4 watts with a secondary impedance of 8Ω.

Model LT-70 is a general-purpose transformer providing economical matching of loudspeakers for most 70.7V distributed sound applications. The insertion loss does not exceed 1.5dB and the frequency response is +1.5dB from 100Hz to 10kHz. Primary taps are .5, 1, 2, and 5 watts with a secondary impedance of 8Ω. Model LT-72 is a quality dual-voltage transformer equipped with terminals for 70.7 and 25V line applications that is recommended for its inventory reducing advantages. The unit's frequency response is +1.5dB from 100Hz to 10kHz and insertion loss does not exceed 1.5dB. The unit features primary taps at .5, 1, 2, and 4 watts with a secondary impedance of 8Ω.

The SSAA-5 is a small analog audio amplifier designed to power a single 8Ω speaker. This device is a perfect solution for small paging and back ground music systems. Its small form factor has been designed to use the existing 70.7V transformer mounting holes that is provided on many Atlas 8" ceiling speakers. The SSAA-5 utilizes a single balanced analog input, 24DC Input, and a 4Ω speaker output.



AF140



Features

- Serves as a Method for Matching Loudspeaker Loads to Amplifier Outputs
- Suitable for Professional and Commercial Sound Applications

Specifications

Frequency Response	30Hz - 15kHz + 1dB
Power Rating	150W
Height	4 $\frac{1}{8}$ " (10.48 cm)
Width	3 $\frac{3}{16}$ " (8.73 cm)
Depth	1 $\frac{3}{8}$ " (3.5 cm)

LT72

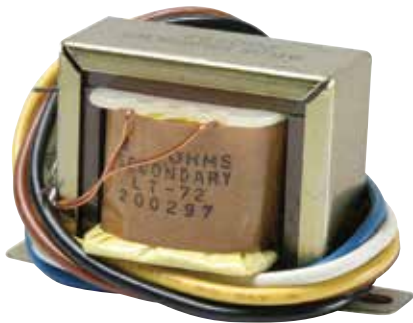

Features

- 70.7V / 25V Line Matching Transformer
- Compact Footprint

Specifications

Frequency Response	100Hz-10KHz +1.5dB
Power Taps	.5, 1, 2 & 4 Watts
Power Rating	4W
Height	1 $\frac{1}{8}$ " (3.5 cm)
Width	1 $\frac{3}{4}$ " (4.366 cm)
Depth	$\frac{3}{4}$ " (1.83 cm)

LT70



Features

- 70.7V Line Matching Transformer
- Compact Footprint

Specifications

Frequency Response	100Hz-10KHz +1.5dB
Power Taps	.5, 1, 2 & 5
Power Rating	5W
Height	1 $\frac{1}{8}$ " (3.5 cm)
Width	1 $\frac{3}{4}$ " (4.36 cm)
Depth	$\frac{3}{4}$ " (1.83 cm)

HT87

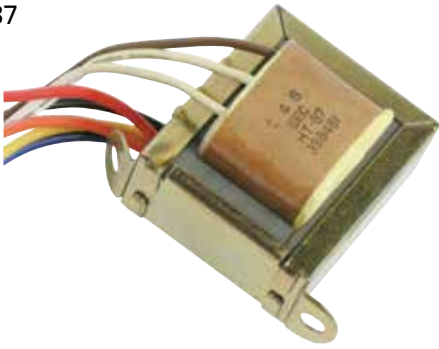

Features

- Constructed with Audio Grade Laminations
- Frequency Response is 50Hz – 15KHz \pm 1dB
- High Quality Matching Transformer with Only 0.6dB insertion loss

Specifications

Frequency Response	50Hz-15KHz (\pm 1dB)
Power Rating	8 Watts
Secondary Impedance	4 Ω and 8 Ω
Power Taps	1, 2, 4 & 8 Watts
Primary Voltage	70.7V
Height	2 $\frac{3}{8}$ " (6 cm)
Width	2" (5 cm)
Depth	1 $\frac{1}{16}$ " (2.6 cm)

HT47

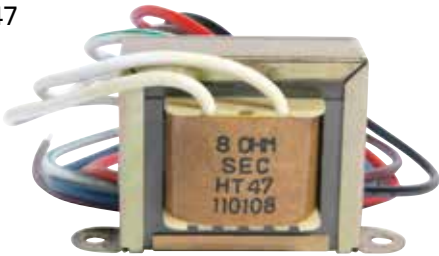

Features

- Constructed with Audio Grade Laminations
- Designed for Use on 70.7V Lines
- High Quality Matching Transformer with Only 1.0 dB Insertion Loss

Specifications

Frequency Response	+1dB-60Hz-12KHz
Power Taps	.5, 1, 2 & 4 Watts
Power Rating	4 Watts
Primary Voltage	70.7V
Height	1 $\frac{5}{8}$ " (4.13 cm)
Width	2" (5 cm)
Depth	$\frac{3}{4}$ " (1.83 cm)

HT42

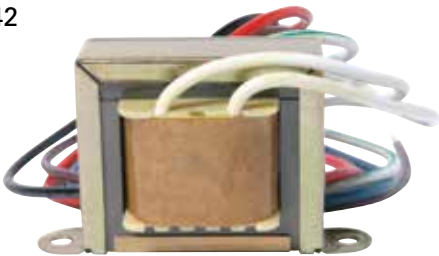

Features

- Constructed with Audio Grade Laminations
- Designed For Use On 25V Lines
- High Quality Matching Transformer With Only 1.0dB Insertion Loss

Specifications

Frequency Response	+1dB-60Hz-12KHz
Power Taps	.5, 1, 2 & 4 Watts
Power Rating	4 Watts
Primary Voltage	25V
Height	1 $\frac{5}{8}$ " (4.13 cm)
Width	2" (5 cm)
Depth	$\frac{3}{4}$ " (1.83 cm)

HT167



Features

- Constructed with Audio Grade Laminations
- High Quality Matching Transformer with Only 0.6dB Insertion Loss
- Secondary Outputs Offer Both 4Ω & 8Ω Impedance

Specifications

Frequency Response	40Hz-15KHz (±1dB)
Power Taps	4, 8 & 16 Watts
Power Rating	16 Watts
Primary Voltage	70.7V
Height	3 ¹ / ₈ " (7.94 cm)
Width	20 ⁹ / ₁₆ " (6.51 cm)
Depth	10 ¹ / ₁₆ " (2.62 cm)

HT-327



Features

- Constructed with Audio Grade Laminations
- High Power Handling Unit
- High Quality Matching Transformer with Only 0.6dB Insertion Loss
- Secondary Outputs Offer Both 4Ω & 8Ω Impedance

Specifications

Frequency Response	30Hz-15KHz (±1dB)
Power Taps	8, 16 & 32 Watts
Power Rating	32 Watts
Primary Voltage	70.7V
Height	3 ¹ / ₄ " (83mm)
Width	2 ¹ / ₂ " (64mm)
Depth	3 ¹ / ₄ " (83mm)

T10



Features

- 15 Watt Line Transformer
- 25V/70.7V Operation
- Perfect For Use With Atlas Sound Compression Drivers

Specifications

Height	1 ⁷ / ₈ " (4.8 cm)
Width	1 ⁵ / ₈ " (4.1 cm)
Depth	1 ¹ / ₁₆ " (1.8 cm)
Frequency Response	60Hz - 20kHz (±1dB)

T18



Features

- 60 Watt 70.7V Line Transformer
- High Power Rating Is Perfect For Use With Horns In High Noise Environments

Specifications

Frequency Response	60Hz–20kHz (±1.5dB)
Height	2¼" (5.7 cm)
Width	2¹¹⁄₁₆" (6.8 cm)
Depth	1" (2.5 cm)

T20



Features

- 30 Watt 70.7V Line Transformer
- Perfect For Use With Horns In High Noise Environments

Specifications

Height	1½" (4.1cm)
Width	10¹⁵⁄₁₆" (4.9 cm)
Depth	¾" (1.9 cm)

SSAA5



Features

- Small Form Factor
- Balance Input
- Mounts to Atlas Sound 8" Ceiling Speakers
- Output is Short-circuit Proof with Internal Thermal Limiting
- Level Control
- 24VDC Input
- Terminal Screw Input
- Power Supply Sold Separately

Specifications

Input Impedance	150K Ω
Input Level	500mv (-6dB) Balanced
Frequency Response	80Hz – 15KHz (+/- 1dB)
THD	.25% @ 1KHz
24VDC Power Requirements	1.3A Max
Height	1⅞" (34.9mm)
Width	2¾" (60.3mm)
Depth	1" (25.4mm)
Weight	6 oz. (.170 kg)



Powered speakers are an economical, easy to use and install solution that can be implemented in a wide variety of applications where fixed install is not a requirement.



Powered Speakers

Applications

Atlas Sound SMA and SMP speakers feature a 2-way design that delivers high fidelity sound that can be used in a variety of applications including cafeterias, classrooms, restaurants/bars, DJ's, and other applications where sound reinforcement of live or recorded music or vocals are required.

Features

- Single Woofer and Compression Driver 2-Way Speaker Design
- Amplified and Passive Models Available
- 12" and 15" Woofer Models Available
- Enclosed Cabinet
- High Frequency, Mid Frequency, and Low Frequency Adjustments
- RCA, XLR, and ¼" Mic Inputs for a Variety of Sources

General Description

The Atlas Sound SMA-12 and SMA-15 are 2-way powered speakers that include a single woofer, 12" or 15", and a high frequency, horn style compression driver. Each unit features an integrated class-D amplifier that includes RCA, XLR, and ¼" mic inputs. While most commonly used as main speakers, the wide frequency response and adjustability of this series make them ideal for use as stage monitor speakers for concerts or productions.

The SMA-12 and SMA-15 also feature a Speak-On output for connecting to another SMA model or to a passive SMP model. The SMP-12 and SMP-15 are passive models that feature the same 2-way design as the powered versions but are designed to be used in conjunction with a powered SMA version. Each cabinet includes a Speak-On™ connector for connecting to the powered version making them easy to install and share a source with.



Atlas Powered Speakers Are Perfect For Fixed Installations Like Restaurants And Bars As Well As For Mobile DJ's



The AH Series stadium loudspeakers offer the most often requested coverage patterns while providing excellent intelligibility for the most challenging environments including large auditoriums and sport fields.



AH Horn clusters Can Provide Wide Coverage And High Output In A Variety Of Installation Types.

Stadium Horns

Applications

Atlas Sound AH Series horns are 2- and 3- way horn loudspeakers that are designed to deliver high, intelligible output over large areas. With multiple coverage patterns and speaker sizes, the AH Series excel in paging applications for large stadiums, university common areas, outdoor recreation complexes, convention centers and other large installations.

Features

- Constant Directivity Design Offers Controlled Coverage
- Easy Connection Via a Convenient Recessed Terminal Block
- Weather Resistant Construction
- Neutral Gray Finish
- 2- and 3-Way Models Available

General Description

All Atlas AH horn models are weather resistant. Each speaker incorporates a multiple screen configuration to prevent moisture from damaging internal components; a perforated aluminum screen covers the large horn mouth, a secondary screen is in place forward of the high frequency driver, and a third tightly perforated screen protects the woofer(s).

Atlas AH horn loudspeakers are available in 2-Way, 8", 12", and 15" versions as well as 3-Way dual 12" versions. Each size speaker is available in 3 coverage patterns designed to deliver outstanding performance for any application. The 8" and 12" 2-way models are available with either a 65°x65° coverage pattern, 90°x40° coverage pattern, or 90°x90° coverage pattern. All models feature an internal 70.7V transformer with power taps up to 60 watts. The 8" models can handle 100 watts and the 12" models can handle 200 watts when using the 8Ω bypass in direct coupling applications. The 15" 2-way models are available with either a 65°x65° coverage pattern, 90°x40° coverage pattern, or 50°x40° coverage pattern. The 15" models can only be connected in 8Ω direct coupling applications and can handle 250 watts. All 2-way models include a heavy duty-mounting bracket for ease of installation on buildings or other flat surfaces. Atlas also offers a single 15" subwoofer in the AH family that is designed to provide low frequency sound reinforcement in large applications. This unit is omnidirectional and can be used under bleachers or stadium seating. Atlas offers a stand designed to support the subwoofer for concrete slab mounting.

The 3-way AH Series horns are also available in 3 coverage patterns, 40°x20°, 65°x65°, and 90°x40°. These models feature a single 1" compression high frequency driver, a single 1.5" compression midrange driver, and dual 12" low frequency woofers. All 3-way models can only be connected in 8Ω direct coupling applications and can handle 750 watts. These models can also be used in dual amplifier applications where one amplifier controls the low pass frequencies and the second controls the high pass frequencies. The 3-way models can be surface mounted or flown, using the seven, 10mm internally reinforced forged eyebolts.



AH66-8ST-BSG



Features

- (3) Forged Eyebolts Also Included for Suspended Installation
- 100 Watts Power Handling
- Constant Directivity Design Offers Controlled Coverage of 65° Horizontal by 65° Vertical (2kHz Octave Band)
- Driver Compliment Includes 8" Cast Frame Woofer with a 1" Exit Compression Driver Coupled to a 65°H x 65°V HF Horn
- Easy, Weather Resistant Connection Via a Convenient Recessed Terminal Block Located on the Bottom of the Loudspeaker
- Efficiency Rating of 101dB (1W/1m)

Specifications

Driver Type	1" HF and 8" LF
Power Taps	7.5, 15, 30, 60 Watts & 8Ω
Power Rating	100 Watts
Dispersion	65° x 65°
Sensitivity	100dB SPL (70Hz to 17kHz 1/3 octave bands)
Height	20.95" (53.21cm)
Width	17.91" (45.49cm)
Depth	20.98" (53.28cm)
Weight	61.00 lbs (27.67 kgs)

AH94-8ST-BSG



Features

- (3) Forged Eyebolts Also Included For Suspended Installation
- 100 Watts Power Handling
- Constant Directivity Design Offers Controlled Coverage of 90° Horizontal by 40° Vertical (2kHz Octave Band)
- Driver Compliment Includes 8" Cast Frame Woofer with a 1" Exit Compression Driver Coupled to a 90°H x 40°V HF Horn
- Easy, Weather Resistant Connection Via a Convenient Recessed Terminal Block Located on the Bottom of the Loudspeaker
- Efficiency Rating of 101dB (1W/1m)

Specifications

Driver Type	1" HF and 8" LF
Power Taps	7.5, 15, 30, 60 Watts & 8Ω
Dispersion	90° x 40°
Power Rating	100 Watts
Sensitivity	101dB SPL (70Hz to 17kHz 1/3 octave bands)
Height	20.05" (50.92cm)
Width	19.66" (49.93cm)
Depth	19.73" (50.11cm)
Weight	63.00 lbs (28.58 kgs)

AH99-8ST-BSG



Features

- (3) Forged eyebolts also included for suspended installation
- 100 Watts power handling
- Constant Directivity Design Offers Controlled Coverage of 90° Horizontal by 90° Vertical (2kHz Octave Band)
- Driver Compliment Includes 8" Cast Frame Woofer with a 1" Exit Compression Driver Coupled to a 90°H x 90°V HF Horn
- Easy, Weather Resistant Connection Via A Convenient Recessed Terminal Block Located On The Bottom Of The Loudspeaker
- Efficiency Rating of 101dB (1W/1m)

Specifications

Driver Type	1" HF and 8" LF
Power Taps	7.5, 15, 30, 60 Watts & 8Ω
Power Rating	100 Watts
Dispersion	90° x 90°
Sensitivity	101dB SPL (70Hz to 17kHz 1/3 Octave Bands)
Height	21.88" (55.57 cm)
Width	19.66" (49.93 cm)
Depth	19.73" (50.11cm)
Weight	65.00 lbs (29.48 kgs)

AH66-12ST-BSG



Features

- (3) Forged Eyebolts Also Included for Suspended Installation
- 100 Watts Power Handling
- Constant Directivity Design Offers Controlled Coverage of 65° Horizontal by 65° Vertical (2kHz octave band)
- Driver Compliment Includes 8" Cast Frame Woofer with a 1" Exit Compression Driver Coupled to a 65°H x 65°V HF Horn
- Easy, Weather Resistant Connection via a Convenient Recessed Terminal Block Located on the Bottom of the Loudspeaker
- Efficiency Rating of 100dB (1W/1m)

Specifications

Driver Type	1" HF and 12" LF
Power Rating	200 Watts
Power Taps	7.5, 15, 30, 60 Watts & 8Ω
Dispersion	65° x 65°
Sensitivity	102dB
Height	23.88" (60.65 cm)
Width	21.41" (54.38 cm)
Depth	22.57" (57.32 cm)
Weight	82.00 lbs (37.19 kgs)

AH94-12ST-BSG



Features

- (3) Forged Eyebolts Also Included for Suspended Installation
- 100 Watts Power Handling
- Constant Directivity Design Offers Controlled Coverage of 90° Horizontal by 40° Vertical (2kHz octave band)
- Driver Compliment Includes 8" Cast Frame Woofer with a 1" Exit Compression Driver Coupled to a 90°H x 40°V HF Horn
- Easy, Weather Resistant Connection via a Convenient Recessed Terminal Block Located on the Bottom of the Loudspeaker
- Efficiency Rating of 101dB (1W/1m)

Specifications

Driver Type	1" HF and 12" LF
Power Rating	200 Watts
Power Taps	7.5, 15, 30, and 60 Watts & 8Ω
Dispersion	90° x 40°
Sensitivity	103dB
Height	24.68"(62.68 cm)
Width	22.06" (56.03 cm)
Depth	22.57" (57.32 cm)
Weight	85.00 lbs (38.56 kgs)

AH99-12ST-BSG



Features

- (3) Forged Eyebolts Also Included for Suspended Installation
- 100 Watts Power Handling
- Constant Directivity Design Offers Controlled Coverage of 90° Horizontal by 90° Vertical (2kHz Octave Band)
- Driver Compliment Includes 8" Cast Frame Woofer With a 1" Exit Compression Driver Coupled to a 90°H x 90°V HF Horn
- Easy, Weather Resistant Connection Via a Convenient Recessed Terminal Block Located on the Bottom of the Loudspeaker
- Efficiency Rating of 101dB (1W/1m)

Specifications

Driver Type	1" HF and 12" LF
Power Rating	200 Watts
Power Taps	7.5, 15, 30, and 60 Watts & 8Ω
Dispersion	90° x 90°
Sensitivity	103dB
Height	25.68" (65.22 cm)
Width	22.06" (56.03 cm)
Depth	22.57" (57.32 cm)
Weight	87.00 lbs (39.46 kgs)

AH54-15-BSG



Features

- (3) Forged Eyebolts Also Included for Suspended Installation
- 250 Watts Power Handling
- 8Ω Nominal System Impedance (70.7V Operation Via Optional Atlas Sound Model AF140 Transformer)
- Constant Directivity Design Offers Controlled Coverage of 50° Horizontal by 40° Vertical (2kHz Octave Band)
- Driver Compliment Includes 15" Cast Frame Woofer With a 1" Exit Compression Driver Coupled to a 50°H x 40°V HF Horn
- Easy, Weather Resistant Connection Via A Parallel 4-Pole Terminal Block Connector

Specifications

Driver Type	
LF	15" Cast Frame Woofer
HF	1" Compression Driver with Titanium Diaphragm
Power Rating	250 Watts (53V) RMS
Frequency Response	75Hz - 14.5 kHz (±5dB)
Dispersion	50° x 40°
Sensitivity	104dB
Impedance	8Ω
Height	20½" (52.07 cm)
Width	20½" (52.07 cm)
Depth	32" (81.28 cm)
Weight	87 lbs (39.5 kgs)

AH66-15-BSG



Features

- (3) Forged Eyebolts Also Included for Suspended Installation
- 250 Watts Power Handling
- 8Ω Nominal System Impedance (70.7V Operation via Optional Atlas Sound Model AF140 Transformer)
- Constant Directivity Design Offers Controlled Coverage of 65° Horizontal by 65° Vertical (2kHz Octave Band)
- Driver Compliment Includes 15" Cast Frame Woofer With a 1" Exit Compression Driver Coupled to a 65°H x 65°V HF Horn
- Easy, Weather Resistant Connection Via A Parallel 4-Pole Terminal Block Connector
- Efficiency Rating of 104dB (1W/1m)

Specifications

Driver Type	
LF	15" Cast Frame Woofer
HF	1" Compression Driver with Titanium Diaphragm
Power Rating	250 Watts
Frequency Response	75Hz - 14.5kHz (±5dB)
Dispersion	65° x 65°
Sensitivity	104dB
Impedance	8Ω
Height	20½" (52.07 cm)
Width	20½" (52.07 cm)
Depth	32" (81.28 cm)
Weight	87.00 lbs (39.5 kgs)

AH94-15-BSG



Features

- (3) Forged Eyebolts Also Included for Suspended Installation
- 250 Watts Power Handling
- 8Ω Nominal System Impedance (70.7V Operation Via Optional Atlas Sound Model AF140 Transformer)
- Constant Directivity Design Offers Controlled Coverage of 90° Horizontal by 40° Vertical (2kHz Octave Band)
- Driver Compliment Includes 15" Cast Frame Woofer with a 1" Exit Compression Driver Coupled to a 90°H x 40°V HF Horn
- Easy, Weather Resistant Connection Via A Parallel 4-Pole Terminal Block Connector
- Efficiency Rating of 104dB (1 W/1m)

Specifications

Driver Type	
LF	15" Cast Frame Woofer
HF	1" Compression Driver with Titanium Diaphragm
Power Rating	250 Watts
Frequency Response	75Hz - 14.5kHz (±5dB)
Dispersion	90° x 40°
Sensitivity	104dB
Impedance	8Ω
Height	20½" (52.07 cm)
Width	30" (76.2 cm)
Depth	31" (78.74 cm)
Weight	100 lbs (45.4 kgs)

AH42-212-BSG



Features

- 3-Way Design
- Single 1" Exit Compression Driver
- Single 1.5" Exit Midrange Compression Driver
- 8Ω Nominal Impedance
- Weather Resistant Connection Via a Convenient Recessed Terminal Block Located on the Bottom of the Loudspeaker
- Dual 12" Cast Frame Woofers
- 40° x 20° Dispersion
- Seven, 10mm Internally Reinforced Forged Eyebolts Included for Suspended Installation

Specifications

Power Handling (Full Range)	750 Watts
Power Handling (Bi-Amp)	
High Pass	250 Watts
Low Pass	800 Watts
Sensitivity (1W/1m)	106dB (80Hz - 17kHz average)
Frequency Response	100Hz - 17kHz
Dispersion	40° x 20°
Nominal Impedance	8Ω
Minimum Impedance	4.9Ω @ 80Hz
Height	32.53" (82.63 cm)
Width	32.53" (82.63 cm)
Depth	47.11" (119.67 cm)
Weight	300 lbs (136.08kg)

AH66-212-BSG



Features

- Single 1" Exit Compression Driver
- 3-Way Design
- Single 1.5" Exit Midrange Compression Driver
- 8Ω Nominal Impedance
- Weather Resistant Connection Via a Convenient Recessed Terminal Block Located on the Bottom of the Loudspeaker
- Dual 12" Cast Frame Woofers
- 65° x 65° Dispersion
- Seven, 10mm Internally Reinforced Forged Eyebolts Included for Suspended Installation

Specifications

Power Handling (Full Range)	750 Watts
Power Handling (Bi-Amp)	
High Pass	250 Watts
Low Pass	800 Watts
Nominal Impedance	8Ω
Sensitivity (1W/1m)	106dB (80Hz - 17kHz average)
Frequency Response	100Hz - 17kHz
Minimum Impedance	4.9Ω @ 80Hz
Dispersion	65° x 65°
Height	32.53" (82.63 cm)
Width	32.53" (82.63 cm)
Depth	47.11" (119.67 cm)
Weight	300 lbs. (136.08kg)

AH94-212



Features

- Single 1" Exit Compression Driver
- 3-Way Design
- Single 1.5" Exit Midrange Compression Driver
- 8Ω Nominal Impedance
- Weather Resistant Connection Via a Convenient Recessed Terminal Block Located on the Bottom of the Loudspeaker
- Dual 12" Cast Frame Woofers
- 90° x 40° Dispersion
- Seven, 10mm Internally Reinforced Forged Eyebolts Included for Suspended Installation

Specifications

Power Handling (Full Range)	750 Watts
Power Handling (Bi-Amp)	
High Pass	250 Watts
Low Pass	800 Watts
Sensitivity (1W/1m)	105.7 dB (80Hz - 17kHz average)
Frequency Response	100Hz - 17kHz
Dispersion	90° x 40°
Nominal Impedance	8Ω
Minimum Impedance	4.9Ω @ 80Hz
Height	32.53" (82.63 cm)
Width	32.53" (82.63 cm)
Depth	47.11" (119.67 cm)
Weight	300 lbs (136.08kg)

AHSUB15-BSG



Features

- 250 Watts Power Handling
- Easy Installation. Secure Surface Mounting or Suspension Installation is Possible via the Integral Forged Eyebolts
- Easy, Weather Resistant Connection via a Convenient Recessed Terminal Block Located on the Back of the Loudspeaker
- Impressive Efficiency Rating of 103dB 1W/1m Makes the AHSUB15S a Perfect Choice for Low Frequency Augmentation of High Energy Music Playback at Sporting Events
- Maximum Output of 127dB (Rated Power @ 1M)
- Weather & Rodent Resistant. Rear Firing Woofer Cavity and Mesh Screen Over the Enclosure Front Protects the Speaker from Weather and/or Rodent Damag.

Specifications

Driver Type	Treated Paper
Power Rating	250 Watts
Frequency Response	55Hz – 120Hz (±5dB)
Dispersion	Omni
Sensitivity	103dB SPL (1W/1m)
Height	30 ⁹ / ₁₆ " (77.6224 cm)
Width	30" (76.2 cm)
Depth	29 ¹ / ₈ " (73.914 cm)



AH Horns Are Ideally Used In Athletic Fields Or Other Open Spaces Where Long Throw And High Intelligibility Are Required



Atlas Sound offers several horn models that offer excellent dispersion and durability for a variety of applications especially when used with Atlas Sound compression drivers for high output and intelligibility.



DR Horns Can Be Deployed In Amusement Parks As Part Of A High Intelligibility Paging System

Horn Systems

Applications

Atlas Sound horn systems are designed for paging applications and models are available that overcome specific design obstacles often faced by integrators in the field. Atlas horn systems are ideal solutions for industrial facilities, recreation centers, sports fields, amusement parks, transit centers, schools, and other facilities where paging and emergency messaging may be required.

Features

- Industry Standard 1 $\frac{3}{8}$ " – 18 Thread Accommodates All Atlas Compression Drivers
- Mounting Bracket Included
- Weather Resistant Construction

General Description

The DR Series horns are double re-entrant horns that are designed to deliver high quality music and paging signals over large coverage areas. There are four models in the DR Series and each is designed with a specific, uniform coverage pattern. Additionally, these horns incorporate a resonance-damping ring that improves the sound quality through an extended frequency range. These horns feature all-metal construction, making them exceptionally durable and able to withstand harsh climates year round. Each model also features a 1 $\frac{3}{8}$ "-18 female thread allowing them to be used with all Atlas Sound compression drivers. An integrated steel "U" bracket is included with each model enabling integrators to properly position the horn for optimum coverage.

Atlas Sound CD Series horns are re-entrant horns designed to provide uniform sound coverage that is more accurate than a traditional conical shaped horn. There are three models available in the CD Series and each model features a precisely controlled coverage pattern over a defined frequency range. CD Series horns are made using a polyester resin and glass fiber laminate that is molded to a die-cast throat with 1 $\frac{3}{8}$ "-18 female threads. Models can be mounted using the included heavy-duty steel mounting bracket. Units can be positioned in either vertical or horizontal orientation based on project requirement. They can also be used in single or stacked, multi-unit clusters if desired.

Atlas additionally offers two horn models that are designed for wide area coverage. The BIA-100 is a reflex horn featuring a bi-axial design with twin air columns and exponential bell for wide-angle coverage with a linear frequency response. The horn provides excellent acoustic loading maintained to a 350Hz low-frequency roll-off and optimizes delivery of high and mid-range signal levels. The easily mounted horn features the labor-saving patented gimbal-mount bracket assembly (U.S. Patent # 4,325,529) which allows for directional positioning up to 180° vertically and horizontally. It includes a steel bracket, cast-mounting base and provisions for flange installation. The CJ46 is an all-purpose, wide-angle sound projector designed to provide maximum audio penetration through adverse ambient sound levels and coverage over long distances. The CJ46 features a heavy-duty steel mounting bracket with positive lock for horizontal and vertical positioning in single or stacked multi-unit clusters. To meet application requirements, the prime sound dispersion axis may be changed from horizontal to vertical via a 90° bell rotation and four ¼" screws.



DR-32



Features

- Accepts All Standard High Efficiency Compression Drivers with 1 $\frac{3}{8}$ " - 18 Male Threads
- Exponentially-Flared for Uniform Sound Distribution
- Multi-Purpose Reflex Sound Horns for High Intelligibility Sound Distribution and Voice and Signal Applications
- Weatherproof, All-Metal Construction for Year Round Use

Specifications

Depth	12 $\frac{1}{2}$ " (31.75 cm)
Diameter	16 $\frac{1}{2}$ " (41.91 cm)
Dispersion	95°

DR-54



Features

- Accepts All Standard High Efficiency Compression Drivers with 1 $\frac{3}{8}$ " - 18 Male Threads
- Exponentially-Flared for Uniform Sound Distribution
- Multi-Purpose Reflex Sound Horns for High Intelligibility Sound Distribution and Voice and Signal Applications
- Weatherproof, All-Metal Construction for Year Round Use

Specifications

Depth	19" (48.26 cm)
Diameter	26" (66.04 cm)
Dispersion	75°

DR-42



Features

- Accepts All Standard High Efficiency Compression Drivers with 1 $\frac{3}{8}$ " - 18 Male Threads
- Exponentially-Flared for Uniform Sound Distribution
- Multi-Purpose Reflex Sound Horns for High Intelligibility Sound Distribution and Voice and Signal Applications
- Weatherproof, All-Metal Construction for Year Round Use

Specifications

Depth	16" (40.64 cm)
Diameter	21" (53.34 cm)
Dispersion	85°

DR-72



Features

- Accepts All Standard High Efficiency Compression Drivers with 1 $\frac{3}{8}$ " - 18 Male Threads
- Exponentially-Flared for Uniform Sound Distribution
- Multi-Purpose Reflex Sound Horns for High Intelligibility Sound Distribution and Voice and Signal Applications
- Weatherproof, All-Metal Construction for Year Round Use

Specifications

Depth	28" (71.12 cm)
Diameter	31" (78.74 cm)
Dispersion	65°

CD42



Features

- Nominal Frequency Response of 800 Hz - 10 kHz for High-Intelligibility Voice, Signaling
- Coverage of 40° x 20° Across a Wide Frequency Range
- Environment-Resistant Construction for Outdoor/Indoor Applications
- Accepts All Atlas Sound and 1 3/8" - 18 Thread Compression Drivers with Throat Openings of 0.7" Diameter
- Equipped With Standard 1 3/8" - 18 Female Threads for Use with All PD Series Drivers

Specifications

SPL (1W/1m) w/ PD60 Driver	113dB
Dispersion	H, 40°, ±10°, 800Hz-10kHz, V, 20°, ±10°, 2kHz- 10kHz
Low Frequency	
Cut Off	300Hz
Air Column Length	5'
Height	21 1/4"
Width	25 1/2"
Depth	22"

CD64



Features

- High Efficiency Constant Directivity, Re-Entrant Horn Design
- Coverage of 60° x 40° Across a Wide Frequency Range
- Vertical Beamwidth Control Down to 1000hz
- Heavy-Duty Positive Locking Steel Mounting Bracket for Secure Positioning
- Environment - Resistant Construction for Indoor / Outdoor Applications
- Equipped With Standard 1 3/8" - 18 Female Threads for Use with All PD Series Drivers

Specifications

SPL (1W/1m) w/ PD60 Driver	112dB
Dispersion	H, 60°, ±10°, 600Hz-6kHz V, 40°, ±10°, 1000Hz-7kHz
Low Frequency	
Cut Off	300Hz
Air Column Length	4.5'
Height	18 1/4" (463mm)
Width	22 3/4" (578mm)
Length	15" (380mm)

CD94



Features

- High Efficiency Constant Directivity, Re-Entrant Horn Design
- Coverage of 90° x 40° Across a Wide Frequency Range
- Vertical Beamwidth Control Down to 1000hz
- Heavy-Duty Positive Locking Steel Mounting Bracket for Secure Positioning
- Environment - Resistant Construction for Indoor / Outdoor Applications
- Equipped With Standard 1 3/8" - 18 Female Threads for Use with All PD Series Drivers

Specifications

SPL (1W/1m) w/ PD60 Driver	110dB
Dispersion	H, 90°, ±10°, 900Hz-6kHz V, 40°, ±10°, 1000Hz-10kHz
Low Frequency	
Cut Off	300Hz
Air Column Length	4.5'
Height	18 1/4" (463mm)
Width	28 1/4" (718mm)
Length	15" (380mm)

CJ-46



Features

- Directional High-Efficiency Reflex Sound Projector with Wide Angle Dispersion
- Environment-Resistant Construction for Outdoor/Indoor Applications
- Equipped with Standard 1 $\frac{1}{2}$ " - 18 Male Threads for Use with Compression Driver Units
- Heavy-Duty Positive Locking Steel Mounting Bracket for Secure Positioning

Specifications

Dispersion	120° x 60°
Height	12" (30.48 cm)
Width	22" (55.88 cm)
Depth	17" (43.18 cm)

BIA-100



Features

- Accepts All Atlas Sound and 1 $\frac{1}{2}$ " - 18 Thread Compression Drivers with Throat Openings of 0.7" Diameter
- High-Efficiency Bi-Axial Horn Provides 130° x 60° Wide-Angle Sound Coverage
- Nominal Frequency Response of 350-8,000 Hz for High-Intelligibility Voice, Signaling and Full-Range Music in Indoor/Outdoor Applications
- Patented 180° Gimbal-Mount for Installation Flexibility

Specifications

Dispersion	130° x 60°
Height	10 $\frac{1}{4}$ " (26.035 cm)
Width	21" (53.34 cm)
Depth	19 $\frac{1}{4}$ " (48.895 cm)



The Wide Dispersion And High Output Of CD Horns Makes Them Excellent Solutions For Large Campuses Or Complex Facilities That Require Paging Solutions



Atlas Sound offers a wide variety of compression drivers to meet the specific needs of multiple installations. Industry standard threading and high quality materials make PD compression drivers the choice of integration professionals around the world.



Atlas Offers A Variety Of Compression Drivers That Pair With Paging Horns To Provide The Right Volume For Any Application

Compression Drivers

Applications

The Atlas Sound PD Series compression drivers provide accurate sound reproduction, optimum intelligibility, and dependable performance in commercial sound, high-power music, and public address loudspeaker systems.

Features

- Extended Frequency Response Range for Optimum Intelligibility
- Environment-Resistant Construction for Indoor/Outdoor Use
- Most Models Offered With or Without Transformer

General Description

The PD75T features a sound chamber, phasing plug, magnetic-structure components machined to optimum tolerances, 2" voice coil and offers a plane wave frequency response of 100Hz-3.7kHz and is recommended for use in expansive and/or high ambient sound-level areas. The PD75T includes a multi-tap 70.7V transformer as well as a 16Ω bypass allowing it to be used in multiple installation applications. The transformer also includes a protective terminal cover that offers weather resistance and built-in strain relief to assure secure connection.

Atlas Sound PD Series compression drivers are available in multiple styles and power ratings to address the needs of many types of installations. Each model terminates in a 1 $\frac{1}{8}$ "-18 thread male connector that makes them compatible with all Atlas Sound horn systems that require a compression driver. Models PD-30 and PD-30T are rated at 30 watts, include a 1.5" voice coil, and deliver a plan wave frequency response of 300Hz-3.9kHz. The PD-30 features an 8Ω direct-coupled connector and the PD-30T features an integrated 70.7V transformer rated at 30 watts. The PD-30T transformer includes a protective terminal cover that offers built-in strain relief to assure secure connection.

Model PD-5VH features 2" voice coil, 16Ω direct-coupled connection, and delivers a plane wave frequency response of 110Hz-4.1kHz. The PD-5VH also includes an Alnico V-DG magnet that optimizes output while maximizing thermal stability. Model PD-5VT includes the same 2" voice coil found on the PD-5VH but includes a multi-tap 70.7V transformer with power taps up to 40 watts, and delivers a plane wave frequency response of 190Hz-4.2kHz. The PD-5VT transformer includes a protective terminal cover that offers built-in strain relief to assure secure connection.

Models PD-60A and PD-60AT are rated at 60 watts, include a 2" voice coil, and deliver a plan wave frequency response of 100Hz-3.7kHz. The PD-30 features a 16Ω direct-coupled connector and the PD-30T features an integrated multi-tap 70.7V transformer rated at 60 watts. The PD-60AT transformer includes a protective terminal cover that offers built-in strain relief to assure secure connection.



PD75T



Features

- Outstanding Sound Reproduction and Power Handling For Signaling, Music, and Public Address Systems
- Extended Frequency Response Range For Optimum Intelligibility
- 75 Watt Power Rating
- Environment-Resistant Construction For Indoor/Outdoor Use
- Offered with Transformer and 16Ω Tap
- Use With CJ-46, BIA100, DR, and CD Series Horns

Specifications

Plane Wave Freq. Resp.	100Hz - 3.7kHz (±5dB)
Power Taps	2.36, 4.7, 9.4, 19, 38, & 75 Watts
Power Rating	75 Watts
Impedance	16, 67, 133, 267, 533, 1100, & 2100 Ω
SPL 1mW PWT	116dB Avg. 300Hz - 3kHz (±3dB)
Height	7 ¹ / ₈ " (18.1 cm)
Diameter	6 ³ / ₁₆ " (15.7 cm)
Weight	8.2lbs (3.72kg)

PD-60A



Features

- Driver Provides Accurate Sound Reproduction, Optimum Intelligibility And Dependable Performance
- Perfect For High Power Public Address Systems
- Use With CJ-46, BIA100, DR, and CD Series Horns

Specifications

Frequency Response	100Hz - 3.7kHz
Impedance	16Ω
Power Rating	60 Watts
Sensitivity	112.7 (avg) 100 - 3,700 Hz
Height	6 ⁷ / ₈ " (17.46 cm)
Diameter	6 ³ / ₁₆ " (16.19 cm)

PD-60AT



Features

- Driver provides Accurate Sound Reproduction, Optimum Intelligibility And Dependable Performance
- Perfect For High Power 70.7V Public Address Systems
- Use With CJ-46, BIA100, DR, and CD Series Horns

Specifications

Frequency Response	100Hz - 3.7kHz
Power Taps	2.5, 5, 10, 20, 40, & 60 Watts
Power Rating	60 Watts
Sensitivity	112.7 (avg) 100 - 3,700 Hz
Height	6 ⁷ / ₈ " (17.46 cm)
Diameter	6 ³ / ₁₆ " (16.2 cm)

PD-30



Features

- 30-Watt Power Rating
- Environment-Resistant Construction for Indoor/Outdoor Use
- Extended Frequency Response Range for Optimum Intelligibility
- Outstanding Sound Reproduction and Power-Handling For Signaling, Music and Public Address Systems

Specifications

Frequency Response	300Hz - 3.9kHz
Impedance	8Ω
Power Rating	30 Watts
Sensitivity	113.6 (avg) 300-3,900 Hz (+5dB)
Depth	4½" (11.43 cm)
Diameter	4½" (11.43 cm)

PD-30T



Features

- 30-Watt Power Rating
- Environment-Resistant Construction for Indoor/Outdoor Use
- Extended Frequency Response Range for Optimum Intelligibility
- Outstanding Sound Reproduction and Power-Handling For Signaling, Music and Public Address Systems
- BX-1A Conduit Adapter Compatible

Specifications

Frequency Response	300Hz - 3.9kHz
Impedance	70.7V
Power Rating	30 Watts
Sensitivity	113.6 (avg) 300-3,900 Hz (+5dB)
Depth	4½" (11.43 cm)
Diameter	4½" (11.43 cm)

PD-5VH



Features

- 40-Watt Power Rating
- Environment-Resistant Construction for Indoor/Outdoor Use
- Extended Frequency Response Range for Optimum Intelligibility
- Powerful Driver Mounts to Large Format Horns to Deliver Outstanding Sound Reproduction

Specifications

Frequency Response	110Hz - 4.1kHz
Impedance	16Ω
Power Rating	40 Watts
Sensitivity	110.7 (avg) 110 - 4,100 Hz (+5dB)
Height	5½" (13.02 cm)
Width	4¾" (11.11 cm)

PD-5VT



Features

- 40-Watt Power Rating
- Environment-Resistant Construction for Indoor/Outdoor Use
- Powerful Driver Mounts to Large Format Horns to Deliver Outstanding Sound Reproduction

Specifications

Frequency Response	190Hz - 4.2kHz
Power Taps	2.5, 5, 10, 10, 20, & 40 Watts
Impedance	70.7V
Sensitivity	111.2 (avg) 190 - 4,200 Hz (+5dB)
Height	6⅝" (17.46 cm)
Width	6⅝" (16.2 cm)



Atlas Sound environment-resistant horn loudspeakers are the world standard for voice, music, and signal transmission in indoor and outdoor public address, intercom, security, and industrial signal system applications.

Omni Purpose Horns

Applications

Cost-effective, all-purpose units incorporate high-efficiency compression drivers to project through high ambient sound levels and to cover long distances at minimum installed cost. Models assure superior intelligibility and service reliability and are ideal for use in industrial, manufacturing, transportation, gymnasiums, and recreation facilities.

Features

- Weather Resistant Construction
- High Efficiency Compression Drivers

General Description

The Atlas Sound AP-15/AP-15T/AP-15TC and AP-30/AP-30T/AP-30TC are patented environment-resistant, double re-entrant horn loudspeakers designed for medium and high-powered sound distribution systems. The AP-15 is a 15-watt, 8Ω model commonly used in auxiliary or mobile applications while the AP-15T and AP-15TC include a 70.7V/100V transformer with screwdriver adjustable power taps up to 15 watts. The AP-30 is a 30-watt, 8Ω model commonly used in auxiliary or mobile applications while the AP-30T and AP-30TC include a 70.7V/100V transformer with screwdriver adjustable power taps up to 30 watts. All models include the Omni-Purpose® bracket for vertical/horizontal positioning and have provisions for surface/strap mounting to pillars and I-beams. Each model is finished in gray baked epoxy except the AP-15TC and AP-30TC, which have a beige finish.

Model APT-34AT is a surface-mount horn loudspeaker with bi-directional sound dispersion that provides concentrated coverage in corridors, stairwells, and walkways in commercial, institutional and industrial applications. The twin horn assembly includes a 70.7V/100V transformer with Vari-Tap® control connect center that allows for tap selection up to 30 watts or 45Ω connection. The single, integrated compression driver provides 100° sound dispersion in each direction. The APT-34AT includes the Omni-Purpose® bracket and provisions for surface/strap mounting and is finished in gray baked epoxy.

The APC-30T is a high-power 30-watt horn loudspeaker with extended low frequency response that is equipped with a wide-angle molded plastic bell for sound directivity. The integrated 70.7V/100V transformer includes a screwdriver-adjust power selection with a 45Ω tap for intercom and talkback use. The APC-30T also features the Omni-Purpose® bracket for vertical/horizontal positioning and has provisions for surface/strap mounting to pillars and I-beams and is finished in gray baked epoxy.

The APF-15 and APF-15T are vandal resistant horn loudspeakers designed for flange or recessed mounting to panels, interior/exterior walls, or ceilings. The metal construction withstands adverse temperatures, humidity and physical abuse. Model APF-15 provides 15 watts of continuous power at 8Ω and for flexibility and optimum adjustment convenience, the transformer-equipped APF-15T includes the Vari-Tap® control connect center with 7 position, wattage/impedance selection switch with taps up to 15 watts. Weather-resistant metal construction and enclosed wiring terminals eliminate the need and cost of a back box. However, for aesthetic consideration and retrofit convenience, models will flange mount to any standard size ceiling or wall baffle and/or enclosure capable of accommodating conventional 6" or 8" diameter loudspeakers.

Model APR-30AT is a 30-watt loudspeaker with 40° circular sound dispersion that is designed for overhead installation in industrial, transportation, manufacturing, service, recreation and sports centers. The APR-30AT is equipped with an integrated 25V/70.7V/100V transformer with screwdriver-adjust power selection including a 45Ω tap. Provision for suspended ceiling installation is included and the unit is finished in gray baked epoxy.



Industrial And Manufacturing Facilities Are Ideal Locations For Paging Horn Deployments



AP-15

Specifications

Frequency Response	400Hz - 14kHz
Impedance	8Ω
Power Rating	15 Watts
Sensitivity	106dB
Dispersion	70°
Height	8 ¾" (22.2 cm)
Width	7 ⅞" (20 cm)
Depth	90 ⅞" (23.7 cm)
Safety Listing	UL1480

Features

- Gray Finish
- Environment Resistant for Outdoor and Indoor Use
- High-Efficiency Driver with Proven Performance Reliability
- Omni-Purpose® Bracket for Precise Positioning



AP-15T

Specifications

Frequency Response	400Hz - 14kHz
Power Taps	1, 2, 3.8, 7.5, & 15 Watts
Power Rating	15 Watts
Sensitivity	106dB
Dispersion	70°
Height	8¾" (22.2 cm)
Width	7⅞" (20 cm)
Depth	9⅞" (23 cm)
Safety Listing	UL1480

Features

- Gray Finish
- Environment Resistant for Outdoor and Indoor Use
- High-Efficiency Driver with Proven Performance Reliability
- Omni-Purpose® Bracket for Precise Positioning



AP-15TC

Specifications

Frequency Response	400Hz - 14kHz
Power Taps	1, 2, 3.8, 7.5, & 15 Watts
Dispersion	70°
Power Rating	15 Watts
Sensitivity	106dB
Height	8¾" (22.2 cm)
Width	7⅞" (20 cm)
Depth	9⅞" (23.7 cm)

Features

- Beige Finish
- Environment Resistant for Outdoor and Indoor Use
- High-Efficiency Driver with Proven Performance Reliability
- Omni-Purpose® Bracket for Precise Positioning



AP-15TU

Specifications

Frequency Response	400Hz - 14kHz
Impedance	25, 70.7V
Dispersion	70°
Power Rating	15 Watts
Sensitivity	106dB
Height	8¾" (22.2 cm)
Width	7⅞" (20 cm)
Depth	9⅞" (23.7 cm)
Safety Listing	UL1480

Features

- 15-Watt High Efficiency Compression Driver
- Built-In Vari-Tap® Transformer for Easy Impedance Selection
- Omni-Purpose Surface Mounting Bracket



AP-15TUC

Specifications

Frequency Response	400Hz - 14kHz
Power Taps	1, 2, 3.8, 7.5, & 15 Watts
Dispersion	70°
Power Rating	15 Watts
Sensitivity	106dB
Height	8¾" (22.2 cm)
Width	7⅞" (20 cm)
Depth	9⅞" (23.7 cm)
Safety Listing	UL1480

Features

- 15-Watt High Efficiency Compression Driver
- 5 mfd Capacitor for Line Supervision
- Built-In Vari-Tap® Transformer for Easy Impedance Selection
- Recommended for High Intelligibility Paging



AP-15TUCR

Specifications

Frequency Response	400Hz - 14kHz
Power Taps	1, 2, 3.8, 7.5, & 15 Watts
Dispersion	70°
Power Rating	15 Watts
Sensitivity	106dB
Height	8¾" (22.2 cm)
Width	7⅞" (20 cm)
Depth	9⅞" (23.7 cm)
Safety Listing	UL1480

Features

- 15-Watt High Efficiency Compression Driver
- 5 mfd Capacitor for Line Supervision
- Built-In Vari-Tap® Transformer for Easy Impedance Selection





Features

- Environment Resistant for Outdoor and Indoor Use
- Gray Finish
- High-Efficiency Driver with Proven Performance Reliability
- Omni-Purpose® Bracket for Precise Positioning

AP-30

Specifications

Frequency Response	300Hz - 12kHz
Impedance	8Ω
Dispersion	60°
Power Rating	30 Watts
Sensitivity	108dB
Height	11" (27.9 cm)
Width	10" (25.4 cm)
Depth	10½" (26.7 cm)



Features

- Environment Resistant For Outdoor & Indoor Use
- Gray Finish
- High-Efficiency Driver with Proven Performance Reliability
- Omni-Purpose® Bracket for Precise Positioning

AP-30T

Specifications

Frequency Response	300Hz-12kHz
Power Taps	2, 3.8, 15, & 30 Watts
Power Rating	30 Watts
Dispersion	60°
Sensitivity	108dB
Height	11" (27.94 cm)
Width	10" (25.4 cm)
Depth	10½" (26.7 cm)



Features

- Beige Finish
- Environment Resistant For Outdoor & Indoor Use
- Omni-Purpose Mounting Bracket For Precise Positioning
- Transformer Equipped For 25V, 70.7V, or 100V

AP-30TC

Specifications

Frequency Response	300Hz - 12kHz
Impedance	25, 70.7, 100V
Dispersion	60°
Power Rating	30 Watts
Sensitivity	108dB
Height	11" (27.9 cm)
Width	10" (25.4 cm)
Depth	10½" (26.7 cm)



Features

- High-Powered Compression Driver Projects Superior Voice and Tone Signaling
- Includes a 25, 70.7, 100V Transformer with a 45-Ohm Tap
- One-Step Method of Adjusting Bell from Horizontal to Vertical Positioning

APC-30T

Specifications

Frequency Response	300Hz - 12kHz
Power Taps	2, 3.8, 7.5, 15, & 30 Watts
Dispersion	70° x 95°
Power Rating	30 Watts
Sensitivity	109dB
Height	8¼" (21 cm)
Width	14¾" (36.5 cm)
Depth	12⅞" (32.7 cm)



Features

- High Intelligibility for Sound, Intercom and Signal System Use
- Internal 25V/70.7V/100 Transformer

APR-30AT

Specifications

Frequency Response	300Hz - 12kHz
Power Taps	2, 3.8, 7.5, 15, & 30 Watts
Power Rating	30 Watts
Dispersion	40°
Sensitivity	110dB
Depth	10½" (26.7 cm)
Diameter	9¼" (23.5 cm)



Features

- 40 Watt Model Provides Better Output Over Competitive 15 and 30-Watt Standards
- Built-in Screen Protects Against Bug Nesting

APX40TN

Specifications

Frequency Response	400Hz - 75kHz
Power Taps	2.5, 10, 20, 30, & 40 Watts
Power Rating	40 watts
Sensitivity	107dB
Height	10¼" (26 cm)
Width	14½" (36.8 cm)
Depth	13¼" (33.7 cm)



APF-15

Specifications

Frequency Response	600Hz -14kHz
Impedance	8Ω
Dispersion	95°
Power Rating	15 Watts
Sensitivity	104dB
Depth	3 ⁷ / ₁₆ " (8.7 cm)
Diameter	5 ⁵ / ₁₆ " (14.3 cm)
Safety Listing	UL1480

Features

- 8Ω Model
- Choose From Matching Grilles, Enclosures and Mounting. Rings (Order Separately)



APF-15T

Specifications

Frequency Response	600Hz-14kHz
Power Taps	1, 2, 3.8, 7.5, & 15 Watts
Dispersion	95°
Power Rating	15 Watts
Sensitivity	104dB
Depth	5 ³ / ₁₆ " (13.2 cm)
Diameter	5 ⁵ / ₁₆ " (14.3 cm)
Safety Listing	UL1480

Features

- Choose from Matching Grilles, Enclosures and Mounting. Rings (Order Separately)
- Double Re-Entrant Design Provides Superior Audibility of Voice and Tone Signaling



APF-15TU

Specifications

Frequency Response	600Hz-14kHz
Power Taps	1, 2, 3.8, 7.5, & 15 Watts
Dispersion	95°
Power Rating	15 Watts
Sensitivity	104dB
Depth	5 ³ / ₁₆ "(13.2 cm)
Diameter	5 ⁵ / ₁₆ " (14.3 cm)
Safety Listing	UL1480

Features

- Choose From Matching Grilles, Enclosures and Mounting. Rings (Order Separately)
- Double Re-Entrant Design



APF-15TUC

Specifications

Frequency Response	600Hz-14kHz
Power Taps	1, 2, 3.8, 7.5, & 15 Watts
Dispersion	95°
Power Rating	15 Watts
Sensitivity	104dB
Depth	5 ³ / ₁₆ " (13.2 cm)
Diameter	5 ⁵ / ₁₆ " (14.3 cm)
Safety Listing	UL1480

Features

- 15-Watt High-Efficiency Compression Driver
- Built-In Vari-Tap® Transformer for Easy Impedance Selection
- Safety Listed to UL1480



APT-34AT

Specifications

Frequency Response	400Hz - 12.5kHz
Power Taps	2, 3.8, 7.5, 15, & 30 Watts
Dispersion	175°
Power Rating	30 Watts
Sensitivity	101dB
Depth	16 ¹ / ₂ " (42 cm)
Diameter	9 ¹ / ₄ " (23.5 cm)

Features

- Includes 30 Watt High Efficiency Driver.
- Omni-Purpose Mounting Bracket for Positioning Flexibility on Vertical or Horizontal Planes
- Weather Resistant Construction for Indoor or Outdoor Use



WR-5AT

Specifications

Power Handling	7.5 Watts
Transformer Taps	.65, 1.25, 2.5, 5, & 7.5 Watts
Nominal Frequency	375Hz – 10kHz
Sensitivity	97dB
Dispersion	95°
Depth	4" (10.2 cm)
Diameter	6" (15.2 cm)

Features

- 16 Watt Internal Transformer
- 8Ω Transformer Bypass Setting
- Input Via 2 Pole Terminal Strip





Atlas Sound general-purpose horn loudspeakers are commonly specified in a variety of applications where high quality paging with intelligibility are required.

General Purpose Horns

Applications

Atlas Sound general-purpose horn loudspeakers are designed to fit into any design plan. Their all-weather construction and general versatility make them the easy choice for intercom, paging, and alarm applications in commercial buildings, sports facilities, and other applications where direct sound coverage is required.

Features

- Weather Resistant Construction

General Description

Models GA-15T and GA-30T are double re-entrant utility horns that offer economical performance for general paging and music reproduction. Both models feature a combination 25V/70.7V line-transformer with multi-position knob for selecting power taps. In addition, each includes wiring for an 8Ω connection. GA Series models are constructed of weather resistant, high-impact plastic making them ideal for indoor/outdoor installations and feature an adjustable surface-mounting bracket to allow for multiple vertical and horizontal positioning. Both models are finished in gray epoxy.

The SC Series is cost-effective and offers versatility for applications. Each model provides directional sound projection and spot coverage in indoor and outdoor intercom and paging systems or functions as an extension loudspeaker to an alarm system and communication receivers. The SC-15 is an 8Ω speaker that can handle 15 watts and the SC-15-45 handles 15 watts at 45Ω. Both models include a detachable swivel bracket, are weather-resistant, and are finished in light beige epoxy.

The RCMR-15 accessory horn loudspeaker enhances voice intelligibility-range for communications, radio/telephone, electronic hailers and alarm system installations in marine and vehicular applications. The RCMR-15 meets the element and vibration resistance requirements of industrial, service and utility vehicles and is recommended for area paging, intercom and low-power siren applications. Voice coil impedance is 8Ω. The RCMR-15 has a round projector and includes the Omni-Purpose® mounting bracket for vertical and horizontal positioning plus a rigid 90° angle platform-mount.

The MO-2 is a compact, 8Ω unit designed for signal transmission in vehicular alarm, CB, marine radio, and transceiver installations where concealed mounting or minimum aerodynamic obstruction is desired. This double re-entrant unit with platform base is constructed of heavy-gauge, die cast aluminum to minimize potential damage caused by vibration, shock, impact, dust, wide temperature variations, high humidity, salt water and other rigorous conditions. Its integral compression driver provides optimum efficiency and signal intelligibility. The MO-2 is finished in gray epoxy.

The WR-5AT is an environment-resistant loudspeaker that provides the advantages of music reproduction, high-efficiency voice/signal transmission and long-lasting service reliability. The WR-5AT features a specially engineered reflex housing that enhances the frequency response and optimum efficiency of the cone loudspeaker. Weatherproof treatment and construction allows flexibility and dependable performance in indoor and outdoor installations. The unit includes a 25V/70.7V transformer with power taps up to 7.5W and is recommended for background/foreground installations in hotels, schools, pools and recreational facilities. Housed within a metal, weather-resistant enclosure and finished in gray epoxy.



City Park With Paging Horns Deployed To Deliver Weather Or Emergency Alerts



Features

- Compact Size and Styling Enhance Application Flexibility
- Environment Resistant Construction for Long Term Indoor/Outdoor Use

SC-15

Specifications

Frequency Response	600Hz - 6kHz
Impedance	8Ω
Dispersion	95°
Power Rating	15 Watts
Sensitivity	103dB
Depth	6 ¹⁵ / ₁₆ " (17 cm)
Diameter	6 ¹ / ₄ " (15.9 cm)



Features

- Compact Size and Styling Enhance Application Flexibility
- Environment Resistant Construction for Long Term Indoor/Outdoor Use

SC-15-45

Specifications

Frequency Response	600Hz - 6kHz
Impedance	45Ω
Dispersion	95°
Power Rating	15 Watts
Sensitivity	103dB
Depth	6 ¹⁵ / ₁₆ " (17.6 cm)
Diameter	6 ¹ / ₄ " (15.9 cm)



Features

- Multi-Function, Re-Entrant Horn Loudspeakers Offer Efficient Sound Penetration and Dispersion for Paging, Music, and Intercom Use

GA-15T

Specifications

Frequency Response	500Hz - 3kHz
Power Taps	.5, 1, 2, 4, 8, & 15 Watts
Dispersion	80°
Power Rating	15 Watts
Sensitivity	103dB
Depth	9 ⁹ / ₁₆ " (23.8 cm)
Diameter	7 ¹ / ₂ " (19.1 cm)



Features

- Dual Voltage, Knob-Adjustable Impedance Selection for 25/70.7V Line Connection
- Sturdy Construction for Long-Term Indoor and Outdoor Use

GA-30T

Specifications

Frequency Response	500Hz - 3kHz
Power Taps	2, 4, 8, 15, & 30 Watts
Dispersion	60°
Power Rating	30 Watts
Sensitivity	103dB
Depth	12" (30.5 cm)
Diameter	10" (25.4 cm)



Features

- 15-Watt Compression Driver for High Intelligibility Voice Transmission and Electronic Signaling
- Circular Bell for Controlled Sound Dispersion

RCMR-15

Specifications

Frequency Response	700Hz - 5.8kHz
Impedance	8Ω
Dispersion	120°
Power Rating	15 Watts
Sensitivity	105dB
Depth	7 ¹ / ₄ " (18.4 cm)
Diameter	7 ¹ / ₂ " (19.1 cm)



Features

- Heavy-Duty Loudspeaker with Optimum Voice and Signal Intelligibility for Industrial, Marine, Military and Vehicular Applications

MO-2

Specifications

Frequency Response	550Hz - 13.5kHz
Impedance	8Ω
Dispersion	85°
Power Rating	25 Watts
Sensitivity	108dB
Height	8" (20.3 cm)
Width	6 ⁷ / ₈ " (17.4 cm)
Depth	4 ³ / ₁₆ " (10.6 cm)



As part of the most comprehensive line of UL listed products in the commercial audio industry, Atlas Sound HLE and MLE horns and drivers are designed to operate in the most hazardous of conditions.

Explosion Proof Horns & Drivers

Applications

Atlas Sound HLE/MLE horns and compression drivers are designed to operate in hazardous/combustible environments and are UL and CSA listed. These explosion proof horns and drivers are designed to be used in environments like industrial facilities, chemical plants, oil derricks, grain silos, and other installations designated as hazardous where combustible fumes and materials are handled.

Features

- Explosion-Proof Loudspeakers for Signal and Communications Systems
- Listed by UL for Use in Hazardous/Combustible Environments
- Available with Internally Mounted, Factory-Installed Transformer
- Choice of 60 or 30 Watt High-Intelligibility Driver in Cast Aluminum Housing
- Efficiency of Reflex-Style Projectors with Wide Angle or Circular Sound Dispersion

General Description

These UL and CSA (HLE Models only) listed loudspeakers are specified for high-efficiency transmission of voice and/or electronic signals within explosive or combustible atmospheres and environments. Drivers and projector horns may be configured to comply with specific environmental classification groups within Class 1 ratings. The HLE-3/HLE-3T and MLE-3/ MLE-3T are UL rated for use in gas atmospheres, including ethyl, ether, gasoline naphtha, and alcohols, plus hydrogen, gas and vapor. The HLE-1/ HLE-1T and MLE-1/ MLE-1T are UL rated for use in gas atmospheres, including ethyl, ether, gasoline naphtha, and alcohols. HLE Series drivers are 60 watts. MLE Series are 30 watts. Both are offered with an internally mounted line transformer (-T) or with an 8Ω direct coupling connector. To meet UL Standards for loudspeakers in distributed applications, models with factory-mounted transformer (-T) must be specified.

Projector horn model HLE/MLE-30 is a reflex-type sound projector of molded polycarbonate with a 120° x 60° wide-angle dispersion. Model HLE/MLE-32 is an all-metal circular reflex horn with 90° directional sound distribution pattern. Drivers and projector horns are ordered and shipped separately. For performance accuracy, specifications are listed for assembled configurations. All models are equipped with 1/2" conduit access and adjustable mounting bracket.



HLE/MLE-32

Features



- Efficiency of Reflex-Style Projector
- Explosion-Proof Loudspeaker Projector for Signal and Communications Systems
- Listed by UL and CSA for Use in Hazardous/Combustible Environments (Noted Models)
- Requires Either HLE Type or MLE Type Driver

Specifications

Depth	17½" (44.45 cm)
Diameter	16½" (41.91 cm)
Dispersion	95°



HLE/MLE-30

Features

- Efficiency of Reflex-Style Projector
- Explosion-Proof Loudspeaker Projector for Signal and Communications Systems
- Listed by UL and CSA for Use in Hazardous/Combustible Environments (Noted Models)
- Requires Either HLE Type or MLE Type Driver

Specifications

Height	6" (15.2 cm)
Width	14" (35.6 cm)
Depth	17½" (44.5 cm)
Dispersion	120° x 60°



HLE-1

Features

- 60 Watt, 16Ω driver
- Listed by UL for Use in Hazardous/Combustible Environments Approved for Drivers Class 1, Div 1 - C & D Environments
- Can be used with either HLE/MLE-30 OR HLE/MLE-32 horn projectors
- Explosion-Proof Loudspeaker Driver for Signal and Communications Systems
- UL Certified, Safety Listed to UL1203, UL1604, UL2279, and UL913

Specifications

Power Rating	60 Watts
Frequency Response	250Hz - 12kHz
Sensitivity	109dB
Height	6" (152mm)
Width	14" (356mm)
Depth	17½" (445mm)
Safety Listing	UL1203, UL1604, UL2279, UL913, NFPA 503

HLE-1T

Features

- 60 Watt, 70.7V Driver
- Listed by UL for Use in Hazardous/Combustible Environments Approved for Drivers Class 1, Div 1 - C & D Environments
- Can be used with either HLE/MLE-30 OR HLE/MLE-32 horn projectors
- Explosion-Proof Loudspeaker Driver for Signal and Communications Systems
- UL Certified, Safety Listed to UL1203, UL1604, UL2279, and UL913

Specifications

Power Rating	60 Watts
Power Taps	2.5, 5, 10, 20, 40, & 60 Watts
Frequency Response	250Hz- 12kHz
Sensitivity	109dB
Height	6" (152mm)
Width	14" (356mm)
Depth	17½" (445mm)
Safety Listing	UL1203, UL1604, UL2279, UL913, NFPA 503



MLE-1

Features

- 30 Watt, 8Ω Driver
- Listed by UL for Use in Hazardous/Combustible Environments Approved for Drivers Class 1, Div 1 - C & D Environments
- Efficiency of Reflex-Style Projectors with Wide Angle or Circular Sound Dispersion
- Explosion-Proof Loudspeakers for Signal and Communications Systems
- UL Certified, Safety Listed to UL1203, UL1604, UL2279, and UL913

Specifications

Power Rating	30 Watts
Frequency Response	300Hz - 14kHz
Sensitivity	107dB
Height	6" (152mm)
Width	14" (356mm)
Depth	17½" (445mm)
Safety Listing	UL1203, UL1604, UL2279, UL913, NFPA 503

MLE-1T

Features

- 30 Watt, 70.7V Driver
- Listed by UL for Use in Hazardous/Combustible Environments Approved for Drivers Class 1, Div 1 - C & D Environments
- Efficiency of Reflex-Style Projectors with Wide Angle or Circular Sound Dispersion
- Explosion-Proof Loudspeakers for Signal and Communications Systems
- UL Certified, Safety Listed to UL1203, UL1604, UL2279, and UL913

Specifications

Power Rating	30 Watts
Power Taps	1.8, 3.7, 7.5, 15, 30W @ 70.7V
Frequency Response	300Hz - 14kHz
Sensitivity	107dB
Height	6" (152mm)
Width	14" (356mm)
Depth	17½" (445mm)
Safety Listing	UL1203, UL1604, UL2279, UL913, NFPA 503



HLE-3

Features

- 60 Watt, 16Ω driver
- Listed by UL for Use in Hazardous/Combustible Environments Approved for Class 1, Div 1 - B, C, & D Environments
- Can be used with either HLE/MLE-30 OR HLE/MLE-32 horn projectors
- Explosion-Proof Loudspeaker Driver for Signal and Communications Systems
- UL Certified, Safety Listed to UL1203, UL1604, UL2279, and UL913

Specifications

Power Rating	60 Watts
Frequency Response	250Hz - 12kHz
Sensitivity	108dB
Height	6" (152mm)
Width	14" (356mm)
Depth	17½" (445mm)
Safety Listing	UL1203, UL1604, UL2279, UL913, NFPA 503

HLE-3T

Features

- 60 Watt, 70.7V Driver
- Listed by UL for Use in Hazardous/Combustible Environments Approved for Class 1, Div 1 - B, C, & D Environments
- Can be used with either HLE/MLE-30 OR HLE/MLE-32 horn projectors
- Explosion-Proof Loudspeaker Driver for Signal and Communications Systems
- UL Certified, Safety Listed to UL1203, UL1604, UL2279, and UL913

Specifications

Power Rating	60 Watts
Power Taps	2.5, 5, 10, 20, 40, & 60 Watts
Frequency Response	250Hz- 12kHz
Sensitivity	108dB
Height	6" (152mm)
Width	14" (356mm)
Depth	17½" (445mm)
Safety Listing	UL1203, UL1604, UL2279, UL913, NFPA 503



MLE-3

Features

- 30 Watt, 8Ω Driver
- Listed by UL for Use in Hazardous/Combustible Environments Approved for Class 1, Div 1 - B, C, & D Environments
- Efficiency of Reflex-Style Projectors with Wide Angle or Circular Sound Dispersion
- Explosion-Proof Loudspeakers for Signal and Communications Systems
- UL Certified, Safety Listed to UL1203, UL1604, UL2279, and UL913

Specifications

Power Rating	30 Watts
Frequency Response	300Hz - 14kHz
Sensitivity	106dB
Height	6" (152mm)
Width	14" (356mm)
Depth	17½" (445mm)
Safety Listing	UL1203, UL1604, UL2279, UL913, NFPA 503

MLE-3T

Features

- 60 Watt 70.7V Driver
- Listed by UL for Use in Hazardous/Combustible Environments Approved for Class 1, Div 1 - B, C, & D Environments
- Efficiency of Reflex-Style Projectors with Wide Angle or Circular Sound Dispersion
- Explosion-Proof Loudspeakers for Signal and Communications Systems
- UL Certified, Safety Listed to UL1203, UL1604, UL2279, and UL913

Specifications

Power Rating	30 Watts Cont.
Power Taps	2.5, 5, 10, 20, 40, & 60 Watts
Frequency Response	300Hz - 14kHz
Sensitivity	106dB
Height	6" (152mm)
Width	14" (356mm)
Depth	17½" (445mm)
Safety Listing	UL1203, UL1604, UL2279, UL913, NFPA 503



BX-1A

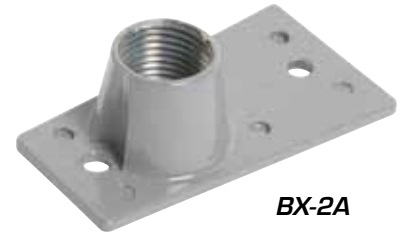

BX-2A



BX-3A



APBK

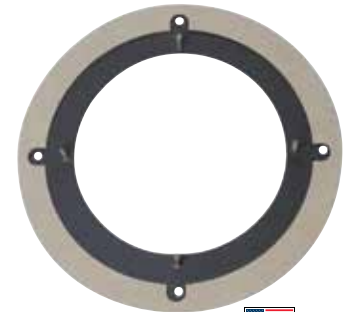

FAMT-6

BX-1A

BX-1A is a vandal resistant cover plate for armored cable and conduit connection. For mounting on APC-30 and APW-30T horn speakers. Constructed of cast aluminum. Threaded for 1/2" pipe thread.

BX-2A

Vandal Resistant Cover Plate for Armored Cable and Conduit Connection on AP-15, AP-15T, and APW-15T Horn Speakers. Constructed of Cast Aluminum. Threaded for 1/2" pipe thread.

BX-3A

BX-3A is a vandal Resistant Cover Plate for Armored Cable and Conduit Connection. For mounting on APF-15, and APF-15T horn speakers. Constructed of Cast Aluminum. Threaded for 1/2" pipe thread.

APBK

Replacement Omni-Purpose® swivel bracket bracket.

FAMT-6

Allows APF horns to be used with 8" baffles.

Atlas Horns Have Been Used In Industrial Facilities Around The World For Over 50 Years

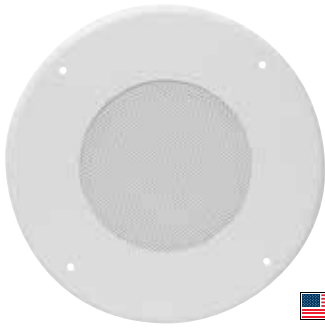

L20-100

Features

- CRS Construction With Baked White Epoxy Finish
- Mounts APF-15 or APF-15T

Specifications



Description Round Grille
 Diameter 11" (279mm)
 Depth 3/16" (5mm)

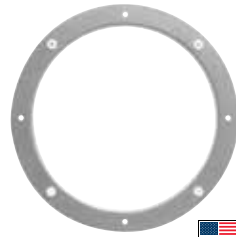

L20-220

Features

- Round Mounting Ring For L20-100 grille

Specifications

Depth 5/8" (15.88mm)
 Diameter 5 9/16" (141.3mm)



L20-101

Features

- CRS Construction With Baked White Epoxy Finish
- Mounts APF-15 or APF-15T

Specifications

Description Square Grille
 Width 10 1/2" (267mm)
 Depth 3/16" (5mm) Deep



L20-222

Features

- Same as L20-220 With Mounting Ears for 24" (610mm) Lay-In Tile

Specifications

Depth 5/8" (16mm)
 Diameter 5 9/16" (141mm)
 Width 24" (610mm)



L20-201

Features

- Recessed 20-gauge.
- CRS enclosure for L20-100 grille
- Includes Combination Conduit Knockouts For Access

Specifications

Depth 6" (152.4mm)
 Diameter 8 9/16" (217.5mm)



193-8

Features

- Furnished with four compound Conduit Knockouts For Standard Screw-Mount Baffle Installation

Specifications

Height 9 1/2" (242mm)
 Width 9 9/16" (242.8mm)
 Depth 6" (152.4mm)



L20-213

Features

- Square Surface Enclosure For Mounting L20-101 grille
- Conduit Knockouts And Mounting Holes Located In Top

Specifications

Height 10 1/2" (266.7mm)
 Width 10 1/2" (266.7mm)
 Depth 6" (152.4mm)



193-8-6

Features

- Furnished with Four Compound Conduit Knockouts for Standard Screw-Mount Baffle Installation

Specifications

Height 9 1/2" (242mm)
 Width 9 9/16" (242.89mm)
 Depth 6" (152.4mm)





Line array speaker systems allow the sound to be focused on the audience area, keeping the sound off the ceiling, the wall behind the audience and the areas above, behind and below the array. Due to their high directivity, arrays excite the reverberant field less and the overall noise decreases in the space. Since there is less overall noise in the space, line arrays tend to be very intelligible in difficult spaces.

A-Line Acoustics

Applications

Atlas A-Line Acoustics line array speaker systems are ideal for a variety of live music and vocal applications. Their small form factor and available wheel board make them easy to set-up in almost any situation including house of worship, club/theater, corporate AV, and outdoor venue installations.

Features

- Highly Intelligible with Natural Sound Reproduction
- Sleek Design Incorporates Into Any Architecture
- Scalable Design
- Great gain before feedback
- Easy to Transport and Set-Up

General Description

The Atlas A-Line EMMA active, modular line array system is a highly intelligible, high efficiency 3-way speaker system ideally suited for use in speech and music reproduction applications like houses of worship, theaters and concert halls. The system consists of two parts: the EM806A-B, which includes eight 6.5" high frequency ribbon drivers and eight 6.5" low / mid frequency drivers and the EMW410A-B, which includes four 10" subwoofers. An integrated class-D amplifier with pre-configured DSP powers each unit, 1500 watts RMS in the EM806A-B and 1000 watts RMS in the EMW410A-B. Both models utilize an optimally designed Baltic birch enclosure. The trim line, two cabinet design allows the units to be stacked to create a sleek, clean looking set up with minimal sightline interference. Atlas Sound additionally offers the EMMA2K-B package, which includes two (2) EM806A-B, two (2) EMW410A-B, two (2) EMWB wheel boards, and all connectors needed to set the units up. Each EMMA line array system is made in the Atlas manufacturing facility in Monroe, WI USA.

The Atlas A-Line ELIJAH line array speaker system is a highly intelligible, high efficiency speaker system that is ideally suited for use in speech and music reproduction applications houses of worship, theaters, and schools. The system consists of two parts: the EJ2003-B, which includes twenty proprietary 3" drivers, and the EJW115, which is a single 15" low frequency driver. Both models utilize an optimally designed Baltic birch constructed enclosure. The EJW115A-B houses an integrated 1000-watt class-D amplifier that includes onboard DSP. The EJW115A-B is designed to provide power to the EJW115X-B and the two EJ2003-B arrays. Each unit is finished in heavy duty black Duracoat™ and the trim line, two cabinet design allows for sleek, clean looking set ups with minimal sightline interference. Atlas also offers each ELIJAH model in a white finish (-W) as well as a fixed install version (I) in both black and white. The ELIJAH2K-B package, which includes two (2) ELJ2003-B, one (1) ELW115A-B, one (1) ELW115X-B, two (2) mounting poles, and all power and speaker cables are included. Input cables are available through the Atlas Signal line.

The Atlas A-Line ELI line array speaker system is a highly intelligible, high efficiency speaker system that is ideally suited for use in speech and



A-Line Acoustics

www.AL4.me



ELI System

music reproduction applications houses of worship, theaters, and schools. The system consists of two parts: the EL1503-B, which includes fifteen proprietary 3" drivers, and the ELW110, which is a single 10" low frequency driver. Both models utilize an optimally designed Baltic birch constructed enclosure. The ELW110A-B houses an integrated 200-watt class-D amplifier that includes onboard DSP. The ELW110A-B is designed to provide power to the ELW110X-B and the two EL1503-B arrays. Each unit is finished in heavy duty black Duracoat™ and the trim line, two cabinet design allows for sleek, clean looking set ups with minimal sightline interference. Atlas also offers each ELI model in a white finish (-W) as well as a fixed install version (I) in both black and white. The ELI2K-B package, which includes two (2) ELJ2003-B, one (1) ELW115A-B, one (1) ELW115X-B, two (2) mounting poles, and all power and speaker cables are included. Input cables are available through the Atlas Signal line.

The SW118A and SW118X are single 18" subwoofer models designed to work in conjunction with an EJ2003-B or EL1503-B in applications where more bass is required. The SW118A includes an integrated 1000-watt class-D amplifier that includes onboard DSP. This amplifier is designed to power the passive SW118X when more than one unit are being used. Each unit is finished in heavy duty black Duracoat™. Atlas also offers each SW model in a fixed install version (I) in both black and white.

Atlas A-Line Acoustics also offers model AL123A-B, a powered large format line array system. This array is highly intelligible with wide coverage and high impact. AL123A cabinets are tri-amplified with a total of 3600 Watts on board power. The DSP in each cabinet is network controlled, allowing precise tuning of the array system. Enclosures feature Atlas A-Line's exclusive integrated EZAL™ rigging system for faster, safer, and easier set up. Up to eight boxes can be individually aimed under load, while flown or stacked, by just one or two people. Made in the USA with the highest-grade components, Atlas A-Line Acoustics AL123 cabinets are constructed of birch plywood with threaded fittings for attachment of speakers, LSRs, rigging and amplifiers.



AL123A

Features

- 3-Way Full Range Speaker System
- 2x 12" Low Frequency Drivers
- 4x 6" Midrange Drivers
- 2x 1.4" High Frequency Drivers
- Baltic Birch Cabinet Construction
- EZAL™ Rigging System
- Finished in Heavy Duty Black Duracoat™

Specifications

Total Power (RMS)	3600 Watts
LF Driver Power (RMS)	2400 Watts
MR Driver Power (RMS)	600 Watts
HF Driver Power (RMS)	600 Watts
Impedance LF/MR/HF	4Ω / 4Ω / 8Ω
MAX SPL	136dB
Frequency Response	70Hz - 18kHz (±3dB)
Connectors	I/O PowerCON™ and M&F XLR
Height	13.9" (35.31cm)
Width	45.3" (115.1cm)
Depth	16.3" (41.4 cm)
Weight	133 lbs (60.33kg)



A-Line Line Array Speakers Systems Provide Excellent Coverage In Live Music Applications

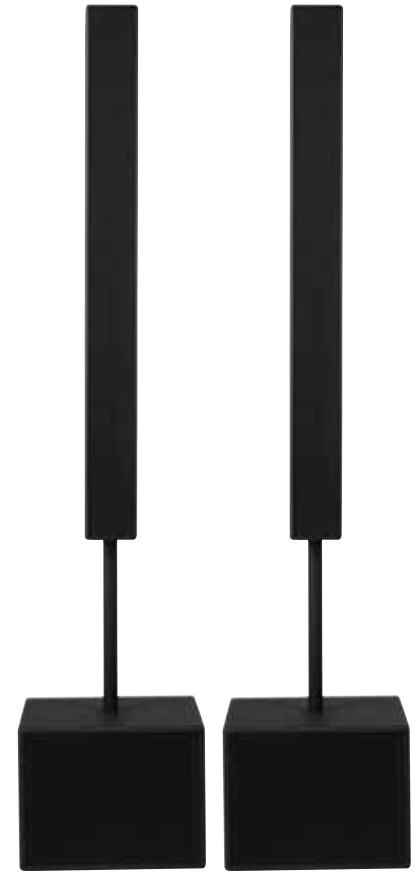

ELI Systems Are Designed To Deliver Highly Intelligible Vocal Reproduction In Small To Medium Sized Venues

EL1503

Features

- Fifteen Proprietary 3" Speakers
- Excellent Pattern Control to 300Hz
- Sealed Baltic Birch Cabinet Design
- Finished in Heavy Duty Black Duracoat™
- NL4 Speakon Connectors
- Available in Black and White

Specifications

Total Power	200 Watts
Impedance	8Ω
Frequency Response	60Hz - 16kHz
MAX SPL 3'	107 dB
Height	49.0" (124.46 cm)
Width	4.25" (10.8 cm)
Depth	6.375" (16.2 cm)
Weight	23 lbs (10.43 kg)

ELW110A

Features

- Single 10" Low Frequency Driver
- Integrated 200W RMS Class D Amplifier
- Finished in Heavy Duty Black Duracoat™
- Available in Black and White

Specifications

Amplifier Power	1000 Watts
Impedance	8Ω
Frequency Response	50Hz - 150Hz
Horizontal Dispersion	Omni
Height	21.6" (54.86 cm)
Width	18.25" (46.36 cm)
Depth	19.4" (49.28 cm)
Weight	65 lbs (29.48 kg)

ELW110X

Features

- Single 10" Low Frequency Driver
- Finished in Heavy Duty Black Duracoat™
- NL4 Speakon Connectors
- Available in Black and White

Specifications

Impedance	8Ω
Frequency Response	50Hz - 150Hz
Horizontal Dispersion	Omni
Height	17.5" (44.45 cm)
Width	13.0" (33.02 cm)
Depth	17.5" (44.45 cm)
Weight	30 lbs (13.61 kg)

ELI2K

Features

- Two EL1503
- One ELW110A
- One ELW110X
- Mounting Poles
- Power and Speaker Cables

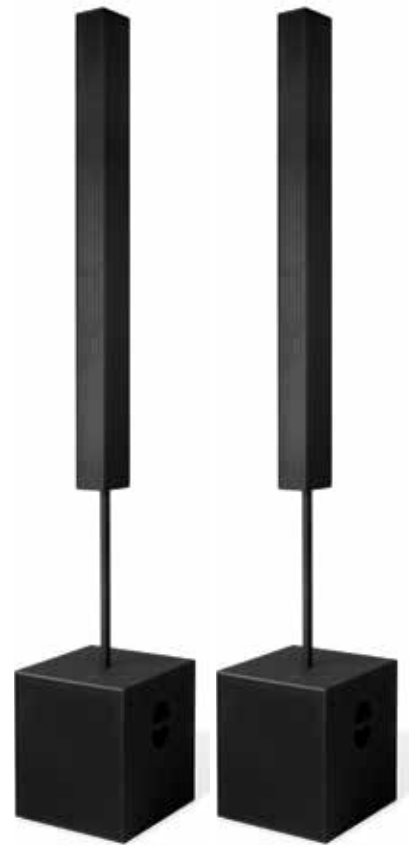

ELIJAH Systems Excel At Reproducing Both Vocal And Live Music Signals

EJ2003

Features

- Twenty Proprietary 3" Full Range Speakers
- Sealed Baltic Birch Cabinet Design
- Excellent Pattern Control to 115Hz Vertically
- Finished in Heavy Duty Black Duracoat™
- NL4 Speakon Connectors
- Available in Black and White

Specifications

Total Power	500 Watts
Impedance	8Ω
Frequency Response	125Hz - 16kHz
MAX SPL 3'	110 dB
Height	65.6" (166.6 cm)
Width	4.8" (12.2 cm)
Depth	6.4" (16.26 cm)
Weight	30 lbs (13.61 kg)

EJW115A

Features

- Single 15" Subwoofer
- Integrated 500W RMS Class D Amplifier
- Finished in Heavy Duty Black Duracoat™
- Available in Black and White

Specifications

Amplifier Power	1000 Watts
Impedance	8Ω
Frequency Response	50Hz - 150Hz
Horizontal Dispersion	Omni
Height	21.6" (54.86 cm)
Width	18.25" (46.36 cm)
Depth	19.4" (49.28 cm)
Weight	65 lbs (29.48 kg)

EJW115X

Features

- Single 15" Subwoofer
- Finished in Heavy Duty Black Duracoat™
- NL4 Speakon Connectors
- Available in Black and White

Specifications

RMS Power	500 Watts
Impedance	8Ω
Frequency Response	50Hz - 150Hz
Height	21.6" (54.86 cm)
Width	18.25" (46.36 cm)
Depth	19.4" (49.28 cm)
Weight	55 lbs (24.95 kg)

ELIJAH2K

- Two EJ2003-B
- One EJW115A-B
- One EJW115X-B
- Mounting Poles
- Power and Speaker Cables



EMMA Systems Are Designed To Cover Large Areas And Deliver Highly Intelligible Speech And Live Music



EM806A

Features

- Eight 6.5" High Frequency Ribbon Drivers
- Eight 6.5" Midrange Drivers
- Integrated 1500W Class D Amplifier
- Integrated Carrying Handles for Easy Transport
- Heavy Duty Duracoat™ Finish
- M&F XLR & I/O Powercon Connectors
- Available in Black and White

Specifications

RMS Power	1500 Watts
Midrange RMS	1000 Watts
High Frequency RMS	500 Watts
Frequency Response	90Hz - 19kHz
Crossover Frequency	90Hz / 125Hz Up to 2kHz
MAX SPL 3'	130dB
Horizontal Dispersion	120°
Height	54.6" (138.68 cm)
Width	13.1" (33.27 cm)
Depth	9.4" (23.88 cm)
Weight	105 lbs (47.63 kg)

EM410A

Features

- Four 10" Subwoofers
- Integrated 1000W Class D Amplifier
- Integrated Carrying Handles for Easy Transport
- Heavy Duty Duracoat™ Finish
- M&F XLR & I/O Powercon Connectors
- Available in Black and White

Specifications

RMS Power	1000 Watts
Frequency Response	40Hz - 125Hz
Crossover Frequency	90Hz/125Hz
MAX SPL	128 dB
Horizontal Dispersion	Omni
Height	48.8" (123.95 cm)
Width	13.1" (33.27 cm)
Depth	19.0" (48.26 cm)
Weight	97 lbs (44.00 kg)

EMMA2K

Features

- Two EM806A
- Two EM410A
- Two EMWB Wheel Board Assemblies
- Mounting Poles
- Power and Speaker Cables



SW118A-B



SW118X-W

SW118A

Features

- Single 18" Subwoofer
- Heavy Duty Duracoat™ Finish
- Integrated 500W Class D Amplifier
- NL4 Connectors
- Available in Black and White

Specifications

RMS Power	500 Watts
Frequency Response	40Hz - 125Hz
Crossover Frequency	40Hz/125Hz
Sensitivity	97.5dB
Impedance	8Ω
Height	25.13" (63.8 cm)
Width	22.5" (57.1 cm)
Depth	20.18" (51.3 cm)

SW118X

Features

- Single 18" Subwoofer
- Heavy Duty Duracoat™ Finish
- Passive Subwoofer System
- NL4 Connectors
- Available in Black and White

Specifications

RMS Power	500 Watts
Frequency Response	40Hz - 125Hz
Crossover Frequency	40Hz/125Hz
Sensitivity	97.5dB
Impedance	8Ω
Height	25.125" (63.8 cm)
Width	22.5" (57.1 cm)
Depth	20.18" (51.3 cm)

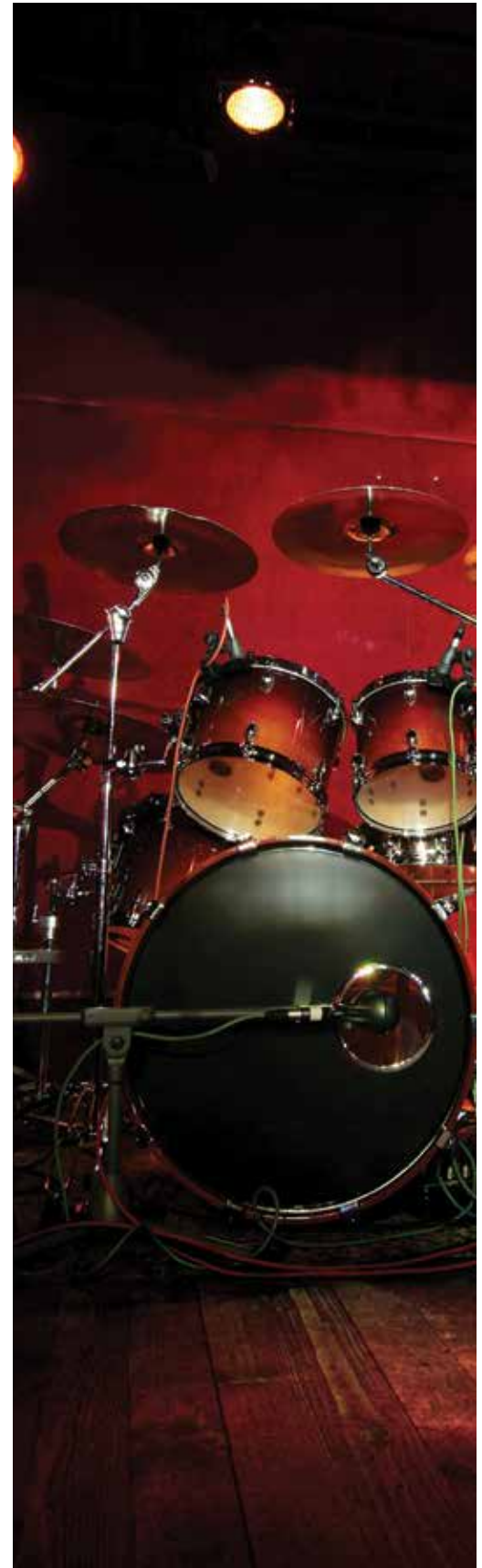

SW118 Subwoofers Can Be Combined With Any A-Line Full Range Speaker For Incredible Low Frequency Reproduction



MTX Audio is one of the premier names in residential audio that Atlas Sound is happy to provide access to for our commercial integrators. There are installations where a higher quality in-wall/in-ceiling speaker or surface mount speaker is required for conference rooms, boardrooms, waiting rooms, or theaters.

MTX® Audio

General Description

MTX Audio is a leading manufacturer of high quality residential custom and cabinet speakers. As a part of the Mitek Corporation, Atlas Sound is able to offer an assortment of residential audio solutions from MTX Audio to the commercial audio market. MTX CT series in wall and in ceiling loudspeakers are available in multiple driver sizes and feature polypropylene woofers and silk dome tweeters. For home theater style applications, the CT series offers a LCR style speaker as well as an in-wall subwoofer model. The CT series include paintable grilles, a convenient dogleg mounting system, and compression terminals that allow them to be easily installed and connected.

The MUSICA series from MTX Audio are an economical in-wall/in-ceiling solution that offers a great balance of performance and value. The MUSICA series offers a variety of sizes that incorporate polypropylene woofers and soft dome tweeters for excellent performance in boardroom and distributed 8Ω applications.

ThunderPro II speakers from MTX Audio are an excellent, high performance speakers designed for public address and live performance applications. This series is available in single 10", single 12", and dual 12" models. Each model incorporates a single woofer and a horn tweeter that is optimized for high output. Each enclosure is constructed using medium density fiberboard (MDF) and is covered in durable airplane grade carpet. Additionally, a high-density plastic carrying handle is installed on each side of the speaker allowing them to be easily transported.

The multi-purpose MODEL series from MTX are designed to be used in surface mount applications where direct connect 8Ω connections are required. These speakers are available in single 4", dual 4", and dual 5" models that deliver up to 75 watts RMS power. The brass hardware, polypropylene cones, and rubber surrounds make these speakers very durable and useful in installations from home theaters to covered outdoor areas.



MPP Home Theater System





Add-A-Zone Kits

- ADZ502W In Wall Kit
- ADZ612C In Ceiling Kit



MTX In-Wall / In-Ceiling

- H625CE 6½" IN-CEILING
- H625WE 6½" IN-WALL
- H622AW 6½" 2-Way In-Ceiling Dual Channel All Weather
- H620AW 6½" 2-Way In-Ceiling All Weather
- M625W 6½" 2-Way Rectangular In-Wall Loudspeaker
- M612W 6½" 2-Way Rectangular In-Wall Loudspeaker
- M512W 5¼" 2-Way Rectangular In-Wall Loudspeaker
- M812C 8" 2-Way Round In-Ceiling Speaker
- M625C 6½" 2-Way Round In-Ceiling Speaker
- M612C 6½" 2-Way Round In-Ceiling Speaker
- M512C 5¼" 2-Way Round In-Ceiling Speaker
- M622C 6½" 2-Way In-Ceiling Speaker (Stereo Input)
- M2525LCR (2) 5¼" 2-Way In-Wall Video Shielded LCR Speaker
- M800SW 8" In-Wall Subwoofer
- CT620W 6½" 2-Way Rectangular In-Wall
- CT620C 6½" 2-Way Round In-Ceiling
- CT520C 5¼" 2-Way Round In-Ceiling
- CT2525LCR Dual 5¼" 2-Way In-Wall Video Shielded LCR Speaker
- CT800SW 8" In-Wall Subwoofer
- CT825W 8" 2-Way Rectangular In-Wall
- CT625W 6½" 2-Way Rectangular In-Wall
- CT825C 8" 2-Way Round In-Ceiling
- CT625C 6½" 2-Way Round In-Ceiling



ThunderPro2

- TP1100 10" 2-Way Professional Loudspeaker System
- TP1200 12" 2-Way Professional Loudspeaker System
- TP2400 Dual 12" 2-Way Professional Loudspeaker System

MPP Home Theater Systems

- MPP4100-B 4" 2-Way, Black
- MPP4100-S 4" 2-Way, Silver
- MPP4100-W 4" 2-Way, White
- MPP410-B 4" 2-Way, Black
- MPP410-S 4" 2-Way, Silver
- MPP410-W 4" 2-Way, White
- MPP4200-S Dual 4" 2-Way, Silver
- MPP4200-W Dual 4" 2-Way, White
- MPP420-S Dual 4" 2-Way, Silver
- MPP420-W Dual 4" 2-Way, White
- MPP520-S Dual 5" 2-Way, Silver
- MPP520-W Dual 5" 2-Way, White



Musica Stereo Volume Controls

- MUSICAVC-50Z 50 Watt Stereo Impedance Matching Volume Control
- MUSICAVC-70ZS 70 Watt Stereo Impedance Matching Volume Control Slider



Soundolier

- DUO 2.4GHZ Floor Lamp / Speaker
- DUO-CP One DUO, One MAESTRO
- MAESTRO 2.4GHZ Transmitter
- MAESTROSWR 2.4GHZ STEREO RECEIVER
- MAESTROSWR-CP One MAESTROSWR, One MAESTRO

MTX Rough-In Kits & Hole Providers Available



Integrators and contractors work hard everyday to bring sound systems alive. Sometimes it is nice for them to kick back and enjoy music on their own time. StreetAudio headphones and portable speakers from MTX Audio deliver high quality portable audio for your smartphone, tablet or computer.



StreetAudio™ by MTX® Audio

Applications

StreetAudio headphones and portable speakers from MTX Audio deliver high quality sound to any music source. StreetAudio in ear and on ear acoustic monitors deliver an outstanding listening experience ideal for use while traveling or just kicking back and relaxing after a tough day on the job.

Features

- 3.5mm Analog Connector
- All Models Include Protective Carrying Case
- Ideal for Smartphones, Tablets, or Computers

General Description

The MTX StreetAudio iX1 on ear acoustic monitors are designed to deliver the MTX sound experience that fans have craved for over 30 years to your smartphone, tablet, or computer. These on ear monitors include a 40mm speaker specifically designed to deliver the extreme bass associated with MTX Audio. The iX1s are constructed using a brushed aluminum band that incorporates dual hinges that allow the unit to fold in half for easy transportation in the included carrying case when they are not in use. Each unit includes a standard audio connection and a connection with an integrated mic/remote that works with Apple® devices. You can connect the audio connection to either the left or right side depending on your preference and style and you can even connect another pair of headphones to the empty port for when you want to share whatever you are listening to with someone else. MTXfans now have the ability to listen to MTX and Feel the Thunder® wherever they go.

MTX StreetAudio iX2 In-Ear Acoustic Monitors are designed to deliver the MTX sound experience that fans have craved for over 30 years to your smartphone, tablet, or computer. These 2-way in-ear monitors include both high frequency and low frequency drivers specifically designed to deliver an unmatched stereo experience. The iX2s are constructed using a brushed aluminum speaker housing and include a Made for Apple® integrated mic/remote. Additionally the iX2s include a protective, zippered carrying case that allows you to store them when you need to. MTX fans now have the ability to listen to MTX and Feel the Thunder® wherever they go.

The MTX StreetAudio iP1 is a portable, powered speaker designed to integrate with your life. This high quality speaker is designed to reproduce high fidelity audio in a small, portable package. The iP1 can be used with any audio source that includes a 3.5mm output or with computers that feature a USB 2.0 connection. The brushed aluminum design is very durable and the rubber back prevents the speaker from sliding once positioned. The iP1 can also be used as the speaker for impromptu conference calls when you or your friends all want to be in on a conversation. When connected to a smartphone, the iP1 can provide more than enough volume for all listeners to hear clearly. The iP1 includes a zippered carrying case that protects the speaker when you are not using it. The internal battery can be recharged using any computer's USB 2.0 port or a power supply that accepts a USB input.



iX1 Red Headphones



iX1

Features

- Includes Made for Apple Mic/Remote Control
- Audio Compatible with All Devices
- Daisy Chain Capability, No Y Adaptor Necessary
- Includes Protective, Zippered Carrying Case
- Tangle Free Cable

Specifications

Sensitivity (1W/1m)	113dB
Impedance	32Ω
Frequency Response	10Hz - 25kHz



iX2

Features

- Includes Made for Apple Mic/Remote Control
- Audio Compatible with All Devices
- Includes Protective, Zippered Carrying Case
- Tangle Free Cable

Specifications

Sensitivity (1W/1m)	115dB
Impedance	32Ω
Frequency Response	10Hz - 25kHz



iP1

Features

- Ideal for Use with Smartphones as Speaker Phone for Group Calls
- USB 2.0 and 3.5mm Inputs
- Aluminum Construction
- Carry Case Included
- Rechargeable via USB Connection

Specifications

Sensitivity (1W/1m)	115dB
Impedance	4Ω
Frequency Response	130Hz - 20kHz





As a full solution provider, Atlas Sound offers integrators all of the solutions they need including often-overlooked items like IR repeaters. Another example how Atlas Sound is a single source provider for AV integrators.

IR Repeaters

Applications

Atlas Sound IR repeaters are designed to give integrators and their clients total control over their installed AV system. Whether it be a boardroom or a home theater room, Atlas IR repeaters can be used to expand the range of IR remote controls even to hidden electronics.

Features

- Small Form Factor Easy Blends Into Surroundings
- Control Multiple AV Devices Remotely

General Description

Atlas Sound IR repeaters allow the operation of virtually any IR-controlled AV component from multiple room locations. The M-1A repeater is designed to receive the IR signal from the transmitter and rebroadcast it to the model F-1 flasher LED positioned on the front of each AV component. The F-1 forwards the signal to the source component's IR receiver allowing it to be controlled.

The M-1A micro repeaters feature an attractive, flush, white lens that blends with any white surface. Their high sensitivity enables use within a 40-foot range with fast reaction time and minimal interference. Repeaters are available installed on a white decorator-style subplate (cover plate not included) or separately for flushmounting in a ceiling, wall, cabinet or speaker grille. The F-1 flasher LEDs include an adhesive backing and 1/8" phone plugs for connection to all IR-controlled A/V components. Up to six flasher units may be connected to a single M-1A repeater using two M-1CB4B connector blocks or any standard adapter (by others).

For installation flexibility Atlas Sound offers the M-1CB4B amplified connector block, which is offered as a plug-in interface device that provides connections for an M-1A repeater, four F-1 flashers, and power supply. This configuration allows IR operation of up to four AV components from up to four room locations. The M-1CB4B offers 1/8" mini jacks for the power supply and up to four F-1 flashers. Additionally, it provides terminals for wiring up to four M-1A repeaters (rooms) in parallel fashion and a data jack for connecting a mini-pin IR source or another M-1CB4B. The unit's amplified circuit design supplies clear, strong IR data to source components.

This stand-alone IR repeater system requires one M-1A repeater in each remote room location, one M-1CB4B for every four A/V components, a power supply, and one F-1 flasher for each AV component. For installations that require control of more than four components or transmission from more than four rooms, multiple M-1CB4B blocks may be used.

M-1A

Specifications

Depth	2" (5.08 cm)
Diameter	1/2" (1.27 cm)
Color	White
Current Draw	12mA
Style	Flush Mount



M-1AJW

Specifications

Height	4 1/2" (11.43 cm)
Width	2 3/4" (6.985 cm)
Depth	2" (5.08 cm)
Shipping Weight	1.00 lb (0.45 kgs)
Current Draw	13mA
Style	Wall Mount



F-1

Specifications

Current Draw	.05 mA
Style	Surface Mount



M-1CB4B

Specifications

Height	1 3/16" (2.07 cm)
Width	3" (7.62 cm)
Depth	1 3/4" (4.445 cm)





Another solution from Atlas Sound illustrating our commitment to providing products that meet the needs and requirements of varying AHJ's; enabling contractors and integrators to get their jobs done.



FR Series

Applications

FR Series speaker assemblies are designed to meet the requirements of varying municipalities regarding fire-resistance. The FR series assemblies are designed to be used in hospitals, restaurants, schools, offices, or other applications that feature drop in or lay in tile ceilings and where city or state regulations require.

Features

- Complete Solution Includes Enclosure, Speaker, Transformer, and Baffle
- Kits are Safety Listed to UL Standard 263
- Lower Installation Cost Versus On-Site Constructed Drywall Fire Boxes

General Description

Atlas Sound FR series speaker assemblies are UL classified for fire resistance in both the United States and Canada. The FR Series has passed a fire rating up to three hours (rating varies by ceiling construction), and has been tested in accordance with the UL standard – Fire Test of Building Construction and Materials, ANSI/UL263 (ASTM E119, NFPA 251). The FR Series is pre-manufactured and assembles quickly on-site with no special tools or skills.

The assemblies include an enclosure-fiber kit, UL listed speaker/transformer assembly, and choice of UL Listed baffle. Each enclosure-fiber kit includes pre-cut fiber panels, metal enclosure, rail set, and hardware. Atlas-Sound FR Series offers a wide variety of cost, performance, and aesthetic options. The 43 speaker/transformer combinations approved for use in FR assemblies are FR versions of the industry standard Atlas Sound Strategy Series FA136 and FA138 models and the C803A, C10A, and FC104 loudspeakers. The approved baffles are also FR versions of familiar Atlas Sound models. In order to maintain UL classification for fire-resistance, enclosure-fiber kits must be used with FR Series components.



FC104T72FRK

Specifications

Included Baffle	51-4FR
Included Enclosure	96-4FR
Included Speaker	FC104T72FR
Safety Listing	ANSI / UL 263 (ASTM E119, NFPA 251)

FC136T87FRK

Specifications

Included Baffle	FA720-6FR
Included Enclosure	FA97-6FR
Included Speaker	FA136T87FR
Safety Listing	ANSI / UL 263 (ASTM E119, NFPA 251)

FC138T87FRK

Specifications

Included Baffle	FA720-8FR
Included Enclosure	FA97-8FR
Included Speaker	FA138T87FR
Safety Listing	ANSI / UL 263 (ASTM E119, NFPA 251)

C803AT87FRK

Specifications

Included Baffle	51-8FR
Included Enclosure	95-8FR
Included Speaker	C803AT87FR
Safety Listing	ANSI / UL 263 (ASTM E119, NFPA 251)

C10AT72FRK

Specifications

Included Baffle	51-8FR
Included Enclosure	95-8FR
Included Speaker	C10AT72FR
Safety Listing	ANSI / UL 263 (ASTM E119, NFPA 251)



Intercom stations that are designed to withstand use and abuse in a variety of installation scenarios with the clarity and quality found only in Atlas Sound speakers.

Intercom Systems

Applications

Atlas Sound intercom stations are designed to meet the needs of many different applications including institutional, corporate, and residential facilities where secure access is required.

Features

- Vandal Proof, Push Button, and Handset Models Available
- Recessed and Surface Mount Options

General Description

Atlas Sound offers several solutions for intercom paging stations. The VPCS series are high-security vandal-proof loudspeaker stations equipped with a 2-1/2" diameter moisture-proof, resin impregnated cone loudspeaker for clear voice and signal transmission with durable performance. VPCS-2GPB-2 Series and VPCS-2G-2 are 2-gang versions and the VPCS-3GPB-245 is a 3-gang model. The overall depth of all units is a shallow 2 5/8" (54mm) allowing installation in standard size E.O. boxes. All models include a two-piece die-cast barrier to protect the loudspeaker assembly from vandalism. Models with "PB" designation include a vandal-proof call switch. The switch is a heavy-duty, momentary action, push-button with a 1.5A 250VAC contact rating. Each model includes a 25V transformer that has power taps of .25, .5, 1 & 2 watts.

The VPVT-4PB is a loudspeaker intercom station that includes a high-efficiency compression driver mounted to a 12-gauge stainless steel plate providing two-way communication for vandal-proof use in detention facilities, correctional institutions, and secured access applications. Rugged recess-mounting assemblies incorporate the patented VT Series, environment-resistant compression driver; recognized throughout the world for dependable performance and effective voice and signal tone distribution. This high-intelligibility, 8Ω compression driver also functions as a microphone to provide clear voice communication. This intercom station includes a 25V transformer with power taps up to 15 watts. The VPVT-4PB can be wall mounted using the VP-77 recessed back box that can be ordered separately. This protective back box is constructed of 16-gauge CRS and finished in black textured enamel.

The VPB-1A is a vandal resistant push switch intercom accessory mounted to a single gang size 12-gauge stainless steel plate. This unit can be used in conjunction with VPVT and VPCS stations or as a stand-alone signaling device when a separate or remotely located call origination button is required. The switch is a SPST normally open circuit with 3 amp contact rating. Vandal proof hardware installs using a 6-32 holt-head driver bit for a standard 1/4" nut driver.

The WPVT-S series models are surface mounting outdoor intercom and paging loudspeaker assemblies designed to provide weatherproof and vandal-proof two-way communication with call-in capability for remote guard and security stations, entry and exit gates, perimeter doors and parking garages. Each model is constructed using an environment-resistant assembly that includes a die-cast, water sealed VT series compression driver loudspeaker. Model WPVT-1SN has an 8Ω connection, WPVT-4SN

includes a 25V transformer with power taps up to 15 watts, and model WPVT-6SN includes a 25V transformer with power taps up to 2 watts. All models include a pre-mounted call SPDT-type switch protected by a weatherproof rubber boot. All models are finished in neutral gray epoxy and install to a standard 4" E.O. Box (not included).

Atlas Sound also offers economical handset assemblies that provide clear and crisp speech reproduction for intercom and paging applications. The CE-2A includes a "500" style handset and two form "C" (DPDT) hook switches mounted to a 2-gang plate with rear mounted terminal strip, color coded leads and spade lugs. Additionally, this unit features a chrome hanger hook switch, neutral handset, flexible coil cord and stainless steel plate for mounting directly to a standard E.O. Box. The CE-2A-AC includes all of the same features found in the CE-2A with the addition of an armored cable for use in higher security areas. Model CE-2A-PT also includes the same features found in the CE-2A with the addition of a factory-installed push-to-talk handset button. This button provides for relay control and a variety of switch, communication, and signaling functions. Contact switch arrangement is SPDT wired as normally open. The TS302A is a surface-mount 2-gang enclosure that can be used with all CE-2A models and is finished in neutral gray epoxy.



VPB-1A

Features

- Field Proven Durability
- SPST NO Switch With a 3A Contact Rating
- Vandal Proof yet Attractive Wall Plate

Specifications

Height	4 1/2" (114mm)
Width	2 3/4" (70mm)
Depth	1 3/8" (35mm)



VPCS-2G-2



Features



- Moisture-Resistant 2½" (64mm) Dia. Cone Loudspeaker
- Offers Smooth Response with High Output in the Speech Range
- Shallow Depth of 2⅛" (54mm) for Mounting in Standard 2 & 3-Gang Back Boxes

Specifications

Height	4¾" (121mm)
Width	4¾" (121mm)
Depth	2⅛" (54mm)
Frequency Response	350Hz - 4.5kHz (±6dB)
Power Taps	.25, .5, 1, & 2 Watts
Sensitivity	88dB
Transformer	25V

VPCS-2GPB-2



Features



- Call Switch Equipped Model
- Choice of Basic or Call Switch Equipped Models
- Durable 11-Gauge, Stainless Steel Face Plate
- Two-Piece Die-Cast Baffle System Protects the Loudspeaker Assembly from Vandalism

Specifications

Height	4¾" (121mm)
Width	4¾" (121mm)
Depth	2⅛" (54mm)
Frequency Response	350Hz - 4.5kHz (±6dB)
Power Taps	.25, .5, 1, & 2 Watts
Sensitivity	88dB
Transformer	25V

VPCS-3GPB-245



Features



- Field Proven Durability
- SPST NO Switch With a 3A Contact Rating
- Vandal Proof yet Attractive Wall Plate

Specifications

Height	4¾" (121mm)
Width	6⅞" (16.1925 cm)
Depth	2⅛" (54mm)
Shipping Weight	4 lbs (1.81 kgs)
Frequency Response	351Hz - 4.5kHz (±6dB)
Power Taps	.25, .5, 1, & 2 Watts
Sensitivity	88dB
Transformer	25V

VPVT-4PB



Features



- Damage Resistant Intercom and Paging Loudspeakers For Indoor Or Outdoor Installation Provide Protected High Intelligibility Communication
- Operational Flexibility of Stations Equipped With Vandal Proof Call/Signal Origination Switch or Optional Stand Alone Push switch Accessory
- Provides Protected High Intelligibility Communication

Specifications

Height	7¼" (184mm)
Width	7¼" (184mm)
Shipping Weight	4.5 lbs (2.04 kgs)
Frequency Response	400Hz - 4kHz
Power Taps	2, 4, 8, & 15 Watts
Sensitivity	102dBA
Transformer	25V



Atlas Sound offers a wide range of life safety speakers that are designed to deliver intelligible communications during the most chaotic of circumstances.



Quality, intelligible life safety speakers can help stop an emergency from becoming a tragedy.

Life Safety Speakers

Applications

Atlas Sound life safety speakers are designed to work in a variety of applications to deliver emergency messaging and fire alarm signals. The options available allow system designers to integrate the speakers so that the message can always be heard whether they are used in an office, a school, a house of worship, or industrial facility.

Features

- Designed for Communications, Intercom, Electronic Alarm, and Monitoring Systems
- 8" In-Ceiling and In-Wall Single and Dual Cone Models
- Recessed and Surface Mount Compression Driver Models
- Safety Listed to UL Standard

General Description

Atlas Sound's UHT and UKT Series are 8" diameter single (UHT) and dual (UKT) voice coil loudspeakers equipped with dual (whizzer) cones and 10 oz. ceramic magnets to deliver extended frequency response with high intelligibility and minimal distortion. These cost-effective units address the requirements for safety listing to the UL1480 standard and come complete with fire-retardant moisture-proof cones, factory-mounted transformers, 6" color-coded leads, and a wide selection of baffles that easily integrate into any architectural theme.

UHT series loudspeakers have a 1" diameter voice coil, choice of 70.7 or 25-volt transformer, and DC blocking capacitor for line supervision applications. UKT series loudspeakers are equipped with dual 1" diameter voice coils, two transformers, either 70.7 or 25 volts, and a DC blocking capacitor. To comply with UL requirements, loudspeaker packages must be used with UL-approved enclosures that are also available from Atlas Sound.

The patented VT and VTF Series from Atlas Sound have earned worldwide acclaim for service reliability and excellent performance. These cost-effective units offer compact size, functional flexibility, optimum intelligibility, effective sound distribution, and high-level output making them ideal for any alarm application. All models contain a high efficiency compression driver with maximum acoustic conversion efficiency, allowing integrators to reduce the number of units needed to obtain specified sound pressure levels and provides substantial savings in amplification-power requirements and labor costs. The VT and VTF models feature die-cast, water-sealed construction that is able to withstand vandalism, vermin, moisture, corrosion, and vibration in either indoor or outdoor use.

VT and VTF loudspeakers are available in a basic 8Ω version as well as 70.7 volt and 25 volt transformer models. All models terminate via barrier strips. VT series models are surface-mount units while VTF series are flush-mount units for recessed installation. VT series mounts standard 4" E.O. boxes and VTF series mount 4" or 4^{11/16}" square back boxes and require model AR or MR adapter rings respectively (order separately). Each VT and VTF model is available in either a neutral (N) or red (R) finish. Optional mounting accessories are offered including: indoor and outdoor enclosures, a bi-directional housing, adapter plates and rings.



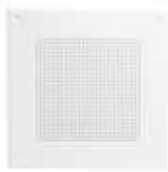

UHT25C-U161-8

Specifications

Frequency Response	85Hz - 8kHz
Power Taps	.5, 1, 2, & 5 Watts
Sensitivity	94dB
Depth	2 ⁷ / ₈ " (7.30 cm)
Diameter	8" (20.32 cm)
Safety Listing	UL1480

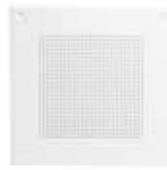

UHT70C-U161-8

Specifications

Frequency Response	85Hz - 8kHz
Power Taps	.5, 1, 2, & 5 Watts
Sensitivity	97dB Peak
Depth	2 ⁷ / ₈ " (7.30 cm)
Diameter	8" (20.32 cm)
Safety Listing	UL1480



UHT25C-U51-8

Specifications

Frequency Response	85 Hz - 8 kHz
Power Taps	.5, 1, 2, & 5 Watts
Sensitivity	94dB Avg.
Depth	2 ⁷ / ₈ " (7.30 cm)
Diameter	8" (20.32 cm)
Safety Listing	UL1480

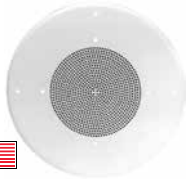

UHT70C-U51-8

Specifications

Frequency Response	85Hz - 8kHz
Power Taps	.5, 1, 2, & 5 Watts
Sensitivity	94dB Avg.
Depth	2 ⁷ / ₈ " (7.30 cm)
Diameter	8" (20.32 cm)
Safety Listing	UL1480

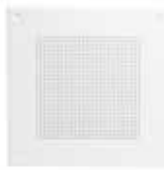

UKT25-2C-U161-8

Specifications

Frequency Response	60Hz - 8kHz
Power Taps	.5, 1, 2, & 5 Watts
Sensitivity	91dB Avg.
Depth	2 ⁷ / ₈ " (7.30 cm)
Diameter	8" (20.32 cm)
Safety Listing	UL1480

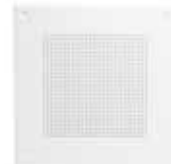

UKT70-2C-U161-8

Specifications

Frequency Response	60Hz - 8kHz
Power Taps	.5, 1, 2, & 5 Watts
Power Rating	10 Watts
Sensitivity	91dB Avg.
Depth	2 ⁷ / ₈ " (7.30 cm)
Diameter	8" (20.32 cm)
Safety Listing	UL1480

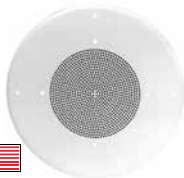

UKT25-2C-U51-8

Specifications

Frequency Response	60 Hz - 8 kHz
Power Taps	.5, 1, 2, & 5 Watts
Sensitivity	91dB Avg.
Depth	2 ⁷ / ₈ " (7.30 cm)
Diameter	8" (20.32 cm)
Safety Listing	UL1480

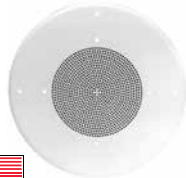

UKT70-2C-U51-8

Specifications

Frequency Response	60Hz - 8kHz
Power Taps	.5, 1, 2, & 5 Watts
Sensitivity	91dB Avg.
Depth	2 ⁷ / ₈ " (7.30 cm)
Diameter	8" (20.32 cm)
Safety Listing	UL1480

VTF-152UCR



Features

- Recessed Compression Driver
- Patented Voice/Tone Loudspeaker for Custom Application in High Efficiency Industrial
- High Efficiency Compression Driver for Optimum Audio Intelligibility
- Water/Moisture, Corrosion, Dust, Vibration, and Vermin-Resistant
- Available in Red (UCR) & Neutral (UCN)

VTF-152UCN



Specifications

Frequency Response	600Hz - 5.5kHz (±5dB)
Power Taps	15, 8, 4, 2
Dispersion	> 190° (- 6dB pt., 1 and 2 kHz octave bands)
Sensitivity	96.9dB
Transformer	25V
Height	6" (152mm)
Width	6" (152mm)
Depth	3 ³ / ₁₆ " (81mm)
Safety Listing	UL1480

VTF-157UCR



Features

- Recessed Compression Driver
- Patented Voice/Tone Loudspeaker for Custom Application in High Efficiency Industrial
- High Efficiency Compression Driver for Optimum Audio Intelligibility
- Water/Moisture, Corrosion, Dust, Vibration, and Vermin-Resistant
- Available in Red (UCR) & Neutral (UCN)

VTF-157UCN



Specifications

Frequency Response	600Hz - 5.5kHz (± 5dB)
Power Taps	15, 8, 4, 2
Dispersion	> 190° (- 6dB pt., 1 and 2 kHz octave bands)
Sensitivity	96.9dB
Transformer	70.7V
Height	6" (152mm)
Width	6" (152mm)
Depth	3 ³ / ₁₆ " (81mm)
Safety Listing	UL1480

VT-152UCR



Features

- Surface Mount Compression Driver
- Patented Voice/Tone Loudspeaker for Custom Application in High Efficiency Industrial
- High Efficiency Compression Driver for Optimum Audio Intelligibility
- Water/Moisture, Corrosion, Dust, Vibration, and Vermin-Resistant
- Available in Red (UCR) & Neutral (UCN)

VT-152UCN



Specifications

Frequency Response	600Hz - 5.5kHz (±5dB)
Power Taps	2, 4, 8, & 15 Watts
Dispersion	> 190° (- 6dB pt., 1 and 2kHz octave bands)
Sensitivity	96.9dB
Transformer	25V
Height	4 ¹ / ₄ " (108mm)
Width	4 ¹ / ₄ " (108mm)
Depth	3 ¹ / ₈ " (79mm)
Safety Listing	UL1480

VT-157UCN



Features

- Surface Mount Compression Driver
- Patented Voice/Tone Loudspeaker for Custom Application in High Efficiency Industrial
- High Efficiency Compression Driver for Optimum Audio Intelligibility
- Water/Moisture, Corrosion, Dust, Vibration, and Vermin-Resistant
- Available in Red (UCR) & Neutral (UCN)

VT-157UCR



Specifications

Frequency Response	600Hz - 5.5kHz (± 5dB)
Power Taps	2, 4, 8, & 15 Watts
Dispersion	> 190° (- 6dB pt., 1 and 2kHz octave bands)
Sensitivity	96.9dB
Transformer	70.7V
Height	4 ¹ / ₄ " (108mm)
Width	4 ¹ / ₄ " (108mm)
Depth	3 ¹ / ₈ " (79mm)
Safety Listing	UL1480





Atlas Sound has been providing sirens for emergency vehicles for over forty years. Atlas takes great pride in building a solution that first responders can count on to help them reach their destination and assist those in need.

Sirens

Applications

Atlas Sound siren loudspeakers are designed to provide clear, audible audio transmission in mobile vehicle warning systems including ambulance, law enforcement, fire, utility, or other public service vehicles.

Features

- Weatherproof Construction
- Designed for Electronic Siren and Signaling Applications

General Description

The HPG-100N siren loudspeaker is utilized for high-powered transmission of electronic siren and voice communications in vehicular applications. It is rated at 100 watts RMS in electronic siren use and will provide a sound level output of 120dB. It is furnished with a one piece, steel-mounting bracket suitable for installation within light bars, engine compartments, in front of the radiator, or on the bumper of an emergency vehicle. The unit features a field-replaceable driver-head assembly ensuring a long functioning product lifespan. Field terminations are via 20" (508 mm) 18-gauge, color-coded wire leads. Lead color is RED and BLACK. The RED lead is connected to the #2 positive driver terminal.

The AS100N is a 100 watt compression driver ideal for use in police, fire, ambulance, and utility vehicles in conjunction with most horns or reflex horns equipped with the industry standard 1 1/8"-18 thread pattern. This driver is equipped with a self-aligning sound chamber assembly containing a 2-3/4" phenolic diaphragm with a nominal impedance of 11Ω. The AS100N is also suitable for use with matched amplifier and control equipment in systems requiring AMECA (Automotive Manufacturer Equipment Compliance Agency, Inc.) certification to General Services Administration specifications (KKK-A-1822C). The AS100N is constructed using a neodymium-iron-boron magnet.

Model LBH-100 is a specially designed siren loudspeaker designed for use in mobile emergency audible warning systems. This siren loudspeaker is made of lightweight, durable cast aluminum that is able to withstand extreme environmental and weather conditions. The unit can be mounted behind the front grille of an emergency vehicle, like a police car, and includes a universal mounting bracket to facilitate installation. The high power handling, excellent dispersion angle, and high sensitivity make the LBH-100 the choice for emergency vehicles around the world.

HPG-100N

Features

- Field-Replaceable Driver-Head Assembly
- 100 Watts RMS

Specifications

Power Rating	100 Watts RMS
Impedance	11Ω Nominal
Frequency Response	575Hz - 3.5kHz (±5dB)
Dispersion	80° x 105°, 1kHz Octave Band



AS100N

Features

- 100 Watt Power Handling for High Intelligibility and Sound Penetration
- Accommodates Most Horns and Reflex Horns with Standard 1 1/8" - 18 Thread Pattern
- Heavy-Duty Weather Resistant Construction
- Neodymium-Iron-Boron Magnet Structure
- Specifically-Designed for Electronic Siren and Signaling applications



Specifications

Shipping Weight	5.00 lbs (2.27 kgs)
Impedance	11Ω
Power Rating	100 Watts
Plane Wave Frequency Response	100Hz - 2.5kHz (±5dB)
Sound Level	117dB (Measured on a plane wave tube @ 1mW)
Low Frequency Limit @ Full Power	500Hz
Height	3" (76 mm)
Diameter	4 5/8" (117 mm)

LBH-100

Features

- Ultra Thin Solid Cast Aluminum Construction
- Sound Output Meets Class A, Article 8, Title 13 of the CHP Vehicle Code, GSA KKK-A-1822D, SAE J1849 When Used with Matching Control Equipment.
- Designed for Use in Police and Emergency Rescue Vehicles as Well as Ambulances and Fire Engines



Specifications

Power Rating RMS	100 Watts
Impedance	11Ω Nominal
Frequency Response	650Hz - 20kHz
Dispersion Angle	80° x 105°
Height	6.5" (165mm)
Width	6.5" (165mm)
Depth	2.25" (57mm)



Attenuators and volume controls are easily integrated solutions that make controlling a sound system easy and user friendly.

Attenuators

Applications

Atlas Sound manufactures a variety of attenuators and volume controls that can be used in a variety of installation scenarios like classrooms, ballrooms, conference centers, lounges, restaurants, and other applications where ambient noise is not always constant and system adjustment is required to compensate.

Features

- Rotary Knob Control
- Wall Plate or Rack Mountable
- 25V, 70.7V, and 8Ω Models Available

General Description

Atlas Sound commercial attenuators are available to support a number of commercial audio applications. The AT Series models are UL listed high-quality autotransformers that provide the advantages of excellent frequency response, low insertion loss, and reliable performance for volume control application in 25V and 70.7V systems. There are three models available, the AT100 (100-watt), AT35 (35-watt), and AT10 (10-watt) that each includes a stainless steel plate with a stamped and filled dial scale as well as a skirted black knob. Attenuation is accomplished in ten steps plus positive "Off" position; there is no "stop" between maximum and "Off" position to prevent damage occurring to the switch. The internal contacts on all models are silver plated for noise-free operation. AT Series attenuators are also available with Decora style wall plates rather than stainless steel. These models, AT100D, AT35D, and AT10D have the same features and specifications as the standard AT Series attenuators. Decora models include both white and ivory plastic wall plates.

Atlas also offers AT Series attenuators that include a priority paging feature that bypasses the effect of the attenuator to provide program level selection of individual emergency and paging signals at the amplifier. These models are available in both wall or rack mount options with the wall mount options including a stainless steel wall plate. In order to use the priority page function in these attenuators, a SPDT relay is included and is operated with 24VDC at 10mA that includes a protective relay cover to ensure lasting trouble-free performance. Models include wall mount AT10-PA, AT35-PA, AT100-PA and rack mount models AT10-PARM, AT35-PARM, AT100-PARM.

Rack mount AT Series options are also available for attenuation convenience of rack-mounted equipment in cabinets and consoles. These models do not include a wall plate for easy rack panel installation. Models AT10-RM, AT35-RM, and AT100-RM include an attractive matte black polycarbonate dial scale overlay with adhesive backing that replaces the mounting plate and a skirted black knob. Atlas offers an attenuator rack-mounting panel, the ATPLATE-052 that can hold up to 6 attenuators in a single rack unit space. Priority paging models are also available as rack mountable options, see previous section.

Atlas Sound also offers the E408-100 attenuator that is specially designed for attenuation in masking and sound reinforcement systems where

fine-tuning of level control is required. The E408-100 employs a ten-position, non-shorting rotary switch without stop. Attenuation rate is 1.5dB per step. All other specifications are the same as the AT Series including the UL listing.

Atlas Sound WhisperTouch volume controls provide for clear, distortion-free stereo music reproduction when one or multiple loudspeaker pairs are powered by a single amplifier. WhisperTouch controls are available in both switched and un-switched varieties. Switched WhisperTouch volume controls provide clear, distortion-free music reproduction for commercial distributed systems or "Whole House" audio designs. These volume controls feature impedance-matching (8Ω versions only) to protect the amplifier and balance the audio signal, fine-tune level control to adjust low listening levels to the perfect setting, and an easy-grip, low profile knob. The knob features smooth detents and make-before-break contacts for smooth transition when changing volume settings. Attenuation is accomplished in 10 steps. All models have frequency response of 20Hz – 20kHz (-3dB, +0).

Units include an on/off switch and indicator light. An internal "smart" relay switch automatically puts speakers into "stand by" mode making them "available" rather than indiscriminately active when the audio system is powered on. Simply touching the switch accesses audio. A modest sized indicator light provides quick visual status (green=standby, red=active). Models require a separate 18-gauge, 2 conductor stranded cable to power the internal relay in addition to the loudspeaker cable. For installation, either a backless E.O. box or sealed box with 18 or 20 in3 volume (Carlson® B120A or equivalent) is required.

Atlas Sound offers traditional autoformer controls, DAT models, to provide excellent stereo performance and maximum speaker-handling capability. Models include positive off and full-power pass through at the maximum setting. Contacts are make-before-break for smooth transition. Model DAT8ST operates with 8Ω impedance suitable for residential stereo and voice-coil circuit application. Model DAT35ST70 can be used with 25V or 70.7V systems to provide level control in distributed constant-voltage systems. Single-gang models mount standard E.O. boxes 2½" deep. Includes both white and ivory knobs, inserts and trim plates.

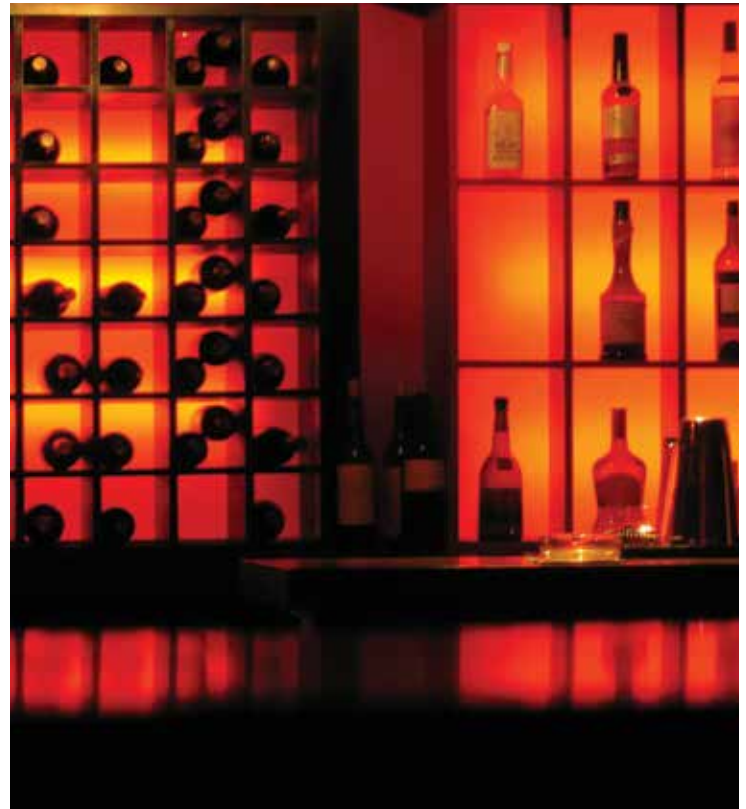

Attenuators And Volume Controls Allow Local Remote Control Of Volume To Compensate For Ambient Noise Fluctuations





AT10

Features

- 10 attenuation steps with positive off
- Mount into Most 1-Gang E.O. Boxes.
- Wall Plates are Stainless Steel with Stamped and Filled Dial Scale, and a Skirted Black Knob

Specifications

Power Rating	10 Watts
Total Attenuation	33dB
Plate Size	1 Gang
Plate Type	Stainless Steel
Height	4½" (11.43 cm)
Width	2¾" (7 cm)
Depth	2⅛" (5.4 cm)
Safety Listing	UL813 & UL2043



AT35

Features

- 10 attenuation steps plus positive off
- Mount into Most 1-Gang E.O. Boxes.
- Wall Plates are Stainless Steel with Stamped and Filled Dial Scale, and a Skirted Black Knob

Specifications

Power Rating	10 Watts
Total Attenuation	33dB
Plate Size	1 Gang
Plate Type	Stainless Steel
Height	4½" (11.43 cm)
Width	2¾" (7 cm)
Depth	2⅛" (5.45 cm)
Safety Listing	UL813 & UL2043



AT100

Features

- 10 attenuation steps plus positive off
- Mount into Most 1-Gang E.O. Boxes.
- Wall Plates are Stainless Steel with Stamped and Filled Dial Scale, and a Skirted Black Knob

Specifications

Power Rating	10 Watts
Total Attenuation	33dB
Plate Size	1 Gang
Plate Type	Stainless Steel
Height	4½" (11.43 cm)
Width	2¾" (7 cm)
Depth	2⅛" (5.4 cm)
Safety Listing	UL813 & UL2043



AT10D

Features

- Attractive Alternative To Commercial Series Attenuators
- Mount into Most 1-Gang E.O. Boxes.
- White and Ivory Plastic Plates with Matching Skirted Knobs in Decora Style

Specifications

Power Rating	10 Watts
Total Attenuation	33dB
Plate Color	White - Ivory
Plate Size	1 Gang
Plate Type	Decora
Height	4½" (11.43 cm)
Width	2¾" (7 cm)
Depth	2⅛" (5.4 cm)
Safety Listing	UL813 & UL2043



AT35D

Features

- Attractive Alternative To Commercial Series Attenuators
- Mount into Most 1-Gang E.O. Boxes.
- White and Ivory Plastic Plates with Matching Skirted Knobs in Decora Style

Specifications

Power Rating	35 Watts
Total Attenuation	33dB
Plate Color	White - Ivory
Plate Size	1 Gang
Plate Type	Decora
Height	4½" (11.43 cm)
Width	2¾" (7 cm)
Depth	2⅛" (5.4 cm)
Safety Listing	UL813 & UL2043



AT100D

Features

- Attractive Alternative To Commercial Series Attenuators
- Mount into Most 1-Gang E.O. Boxes.
- White and Ivory Plastic Plates with Matching Skirted Knobs in Decora Style

Specifications

Power Rating	100 Watts
Total Attenuation	33dB
Plate Color	White - Ivory
Plate Size	1 Gang
Plate Type	Decora
Height	4½" (11.43 cm)
Width	2¾" (7 cm)
Depth	2⅛" (5.4 cm)
Safety Listing	UL813 & UL2043



AT10-PA

Features

- Mount into Most 1-Gang E.O. Boxes.
- Priority Paging Feature By-Passes The Effect Of The Attenuator
- The SPDT relay is operated with 24 VDC at 10mA
- UL Listed
- Wall Plates are Stainless Steel with Stamped and Filled Dial Scale, and a Skirted Black Knob

Specifications

Power Rating	10 Watts
Total Attenuation	33dB
Plate Size	1 Gang
Plate Type	Stainless Steel
Height	4½" (11.43 cm)
Width	2¾" (7 cm)
Depth	2½" (5.4 cm)
Safety Listing	UL813 & UL2043



AT35-PA

Features

- Mount into Most 1-Gang E.O. Boxes.
- Priority Paging Feature By-Passes The Effect Of The Attenuator
- The SPDT relay is operated with 24 VDC at 10mA
- UL Listed
- Wall Plates are Stainless Steel with Stamped and Filled Dial Scale, and a Skirted Black Knob

Specifications

Power Rating	35 Watts
Total Attenuation	33dB
Plate Size	1 Gang
Plate Type	Stainless Steel
Height	4½" (11.43 cm)
Width	2¾" (7 cm)
Depth	2½" (5.4 cm)
Safety Listing	UL813 & UL2043



AT100-PA

Features

- Mount into Most 1-Gang E.O. Boxes.
- Priority Paging Feature By-Passes The Effect Of The Attenuator
- The SPDT relay is operated with 24 VDC at 10mA
- UL Listed
- Wall Plates are Stainless Steel with Stamped and Filled Dial Scale, and a Skirted Black Knob

Specifications

Power Rating	100 Watts
Total Attenuation	33dB
Plate Size	1 Gang
Plate Type	Stainless Steel
Height	4½" (11.43 cm)
Width	2¾" (7 cm)
Depth	2½" (5.4 cm)
Safety Listing	UL813 & UL2043



AT10-PARM

Features

- Attractive Matte Black Polycarbonate Dial Scale Overlay With Adhesive Backing Replaces The Mounting Plate. Includes Skirted Black Knob
- Priority Paging Feature By-Passes The Effect Of The Attenuator
- Rack Mount Attenuator for Mounting on to Blank Panels in Equipment Cabinets
- The SPDT relay is operated with 24 VDC at 10mA

Specifications

Power Rating	10 Watts
Total Attenuation	33 dB
Height	2¾" (7 cm)
Width	1¾" (4.45 cm)
Depth	2½" (5.4 cm)
Safety Listing	UL813 & UL2043



AT35-PARM

Features

- Attractive Matte Black Polycarbonate Dial Scale Overlay With Adhesive Backing Replaces The Mounting Plate. Includes Skirted Black Knob
- Priority Paging Feature By-Passes The Effect Of The Attenuator
- Rack Mount Attenuator for Mounting on to Blank Panels in Equipment Cabinets
- The SPDT relay is operated with 24 VDC at 10mA

Specifications

Power Rating	35 Watts
Total Attenuation	33 dB
Height	2¾" (7 cm)
Width	1¾" (4.475 cm)
Depth	2½" (5.4 cm)
Safety Listing	UL813 & UL2043



AT100-PARM

Features

- Attractive Matte Black Polycarbonate Dial Scale Overlay With Adhesive Backing Replaces The Mounting Plate. Includes Skirted Black Knob
- Priority Paging Feature By-Passes The Effect Of The Attenuator
- Rack Mount Attenuator for Mounting on to Blank Panels in Equipment Cabinets
- The SPDT relay is operated with 24 VDC at 10mA

Specifications

Power Rating	100 Watts
Total Attenuation	33 dB
Height	2¾" (7 cm)
Width	1¾" (4.45 cm)
Depth	2½" (5.4 cm)
Safety Listing	UL813 & UL2043



AT10-RM

Features

- Attractive Matte Black Polycarbonate Dial Scale Overlay With Adhesive Backing Replaces The Mounting Plate. Includes Skirted Black Knob
- Rack Mount Attenuator for Mounting on to Blank Panels in Equipment Cabinets

Specifications

Power Rating	10 Watts
Total Attenuation	33 dB
Height	2¾" (7 cm)
Width	1¾" (4.45 cm)
Depth	2⅛" (5.4 cm)
Safety Listing	UL813 & UL2043



AT35-RM

Features

- Attractive Matte Black Polycarbonate Dial Scale Overlay With Adhesive Backing Replaces The Mounting Plate. Includes Skirted Black Knob
- Rack Mount Attenuator for Mounting on to Blank Panels in Equipment Cabinets

Specifications

Power Rating	35 Watts
Total Attenuation	33 dB
Height	2¾" (7 cm)
Width	1¾" (4.475 cm)
Depth	2⅛" (5.4 cm)
Safety Listing	UL813 & UL2043



AT100-RM

Features

- Attractive Matte Black Polycarbonate Dial Scale Overlay With Adhesive Backing Replaces The Mounting Plate. Includes Skirted Black Knob
- Rack Mount Attenuator for Mounting on to Blank Panels in Equipment Cabinets

Specifications

Power Rating	100 Watts
Total Attenuation	33 dB
Height	2¾" (7 cm)
Width	1¾" (4.45 cm)
Depth	2⅛" (5.4 cm)
Safety Listing	UL813 & UL2043



ATPLATE-052

Features

- 2RU High #14 Gauge Plate Pre-Punched to Accommodate up to Six -RM Attenuators
- Attractive Black Filler Plugs Are Provided For Applications Where The ATPLATE Will Not Be Fully Loaded
- Finished in Flat Black Epoxy to Better Blend in with Other Rack Mount Equipment
- Perfect For Rack Mount Applications Where Attenuators Are Required

Specifications

Rack Spaces	2RU
Panel Type	Steel
Height	3½" (8.9cm)
Width	19" (48.3cm)
Depth	5⁄8" (1.6cm)



E408-100

Features

- 1.5 dB Steps for Sound Masking and Other Precision Applications
- Rack or Plate Mounting
- Wall Plates are Stainless Steel with Stamped and Filled Dial Scale, and a Skirted Black Knob

Specifications

Power Rating	100 Watts
Total Attenuation	15dB
Plate Size	1 Gang
Plate Type	Stainless Steel
Height	4½" (11.43 cm)
Width	2¾" (7 cm)
Depth	2⅛" (5.4 cm)
Safety Listing	UL813 & UL2043



Atlas Sound manufactures a huge assortment of baffles that work with many styles of in-ceiling speakers, meeting the functional and aesthetic requirements of any installation.

Baffles

Applications

Speaker baffles are the part of a ceiling speaker that can be seen by those that work around them and can be an important part of an architectural design by highlighting or blending them into the surroundings. Atlas Sound makes many different baffle styles that can enhance speaker placement or make it disappear in applications like healthcare facilities, institutions, office complexes, commercial buildings, or government facilities.

Features

- CRS, Aluminum, and Plastic Options Available
- Round, Square, and Vandal Proof Options
- Torsion Spring or Screw Mount

General Description

Atlas Sound makes several baffle styles designed to be used with both 4" and 8" speaker sizes. Most models are constructed using cold rolled steel, aluminum, or polystyrene providing long-term durability. These models can be painted to match interior paint schemes if installation requires blending with the ceiling. Models are also available in round or square shapes giving integrators the ability to offer flexible choices to their dealers. Models are also available in either a screw mount or torsion spring mounting style enabling integrators to choose the best and most cost effective method based on their client's needs and budget.

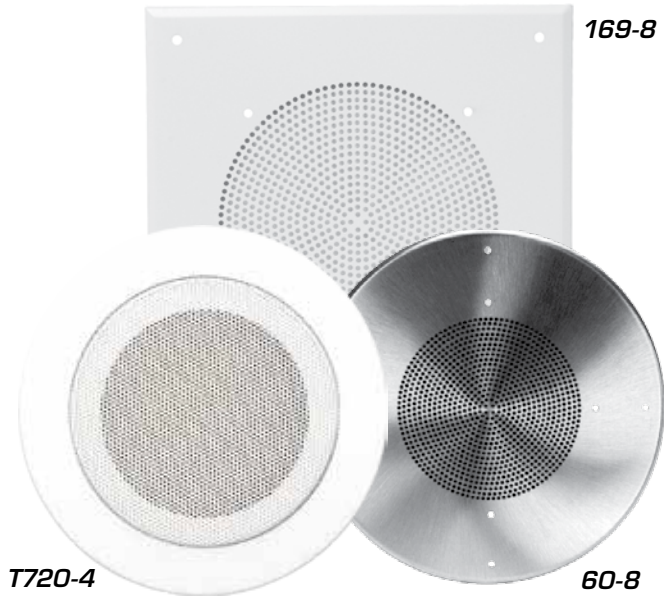

Atlas baffles are created and finished on an automated assembly line at our Ennis, TX manufacturing facility.



Model #	Mounting Rings	Tile Bridges	Enclosures	Safety Listing	Size	Diameter
51-4		81-4	(EZ)96-4 Series, (EZ)96-4X Series	1480	4" (102mm)	7 $\frac{5}{8}$ " (187mm)
51-8	75-8, 76-8(E2), P77-8, P78-8	81-R(S) *EQ81	(EZ)95-8 Series, T95-8 Series, Q408, CS95-8, BMT95-8(7) * (EZ)96-8 Series	1480	8" (203mm)	12 $\frac{3}{4}$ " (323.85mm)
60-8(W)	75-8, 76-8(E2), P77-8, P78-8	81-R(S) *EQ81	(EZ)95-8 Series, T95-8 Series, Q408, CS95-8, BMT95-8(7) * (EZ)96-8 Series	1480	8" (203mm)	12 $\frac{3}{4}$ " (323.85mm)
61-8W	75-8, 76-8(E2), P77-8, P78-8	81-R(S) *EQ81	(EZ)95-8 Series, T95-8 Series, Q408, CS95-8, BMT95-8(7) * (EZ)96-8 Series	1480	8" (203mm)	12 $\frac{3}{4}$ " (323.85mm)
61-12W			95-12, 95-12-12		12 $\frac{3}{4}$ " (324mm)	17 $\frac{1}{4}$ " (438.15mm)
62-8	75-8, 76-8(E2), P77-8, P78-8	81-R(S) *EQ81	(EZ)95-8 Series, T95-8 Series, Q408, CS95-8, BMT95-8(7) * (EZ)96-8 Series	1480	8" (203mm)	12 $\frac{3}{4}$ " (323.85mm)
P900	75-8, 76-8(E2), P77-8, P78-8	81-R(S) *EQ81	(EZ)95-8 Series, T95-8 Series, Q408, CS95-8, BMT95-8(7) * (EZ)96-8 Series		8" (203mm)	12 $\frac{3}{4}$ " (323.85mm)
M222W	75-8, 76-8(E2), P77-8, P87-8	81-R(S) *EQ81	(EZ)95-8 Series, T95-8 Series, Q408, CS95-8, BMT95-8(7) * (EZ)96-8 Series		8" (203mm)	12 $\frac{3}{4}$ " (323.85mm)
161-4			198-4, SE198-4	1480	4" (102mm)	7" (177.8mm)
161-8		81-8S	198-8 Series, SE175-4	1480	8" (203mm)	11 $\frac{1}{2}$ " (292.1mm)
164-8A(-052)		81-8S	(SM) 191-78 Series, Q418, QS408		8" (203mm)	12 $\frac{5}{8}$ " (320.675mm)
164-12A(-052)			Q4412, Q4612, Q4712, Q4812		12" (304.8mm)	16" (406.4mm)
164-15A			Q4915		15" (381mm)	20 $\frac{1}{8}$ " (509.5875mm)
169-8	73-8(E1)	81-8S	193-8(-6)		8" (203mm)	10 $\frac{1}{2}$ " (266.7mm)
170-8A	75-8, 76-8 (E2), P77-8, P78-8	81-R(S) *EQ81	(EZ)95-8 Series, T95-8 Series, Q408, CS95-8, BMT95-8(7) * (EZ)96-8 Series	1480/2043	8" (203mm)	13 $\frac{1}{2}$ " (342.9mm)
410-4			(49 octagon E.O. box)			
510-4			(49 octagon E.O. box)			
830-89A			194-89, SM194-89		8" (203mm)	
830-812A			194-812, SM194-812		8" (203mm)	
840-89A			195-89, SM195-89		8" (203mm)	
840-812A			195-812, SM195-812		8" (203mm)	
T51-4	PR411	FA81-4	E410(-11), E410-NK, EZE410		4" (102mm)	7 $\frac{5}{8}$ " (187.325mm)
T51-84			BMT95-4(-7)		4" (102mm)	8 $\frac{1}{2}$ " (215.9mm)
T51-8	T75-8(E1)(E2)	81-8S	T95-8 Series, EZ195-8, BMT95-8(-7), EZ95-8		8" (203mm)	12 $\frac{3}{4}$ " (323.85mm)
T61-8W	T75-8(E1)(E2)	81-8S	T95-8 Series, EZ195-8, BMT95-8(-7), EZ95-8		8" (203mm)	12 $\frac{3}{4}$ " (323.85mm)
T62-8	T75-8(E1)(E2)	81-8S	T95-8 Series, EZ195-8, BMT95-8(-7), EZ95-8		8" (203mm)	12 $\frac{3}{4}$ " (323.85mm)
T720-4	PR411	FA81-4	E410, EZE410		4" (102mm)	7 $\frac{5}{8}$ " (187.325mm)
T720-4BT	PR411		BMT95-4(7), (EZ)E410 Series		4" (102mm)	8 $\frac{1}{2}$ " (215.9mm)
T720-8A	T75-8(E1)(E2)	81-8S	T95-8 Series, BMT95-8(-7), EZ95-8		8" (203mm)	12" (304.8mm)
VP60R	75-8(E2), 76-8(E2)		(T)95-8 Series, 96-8 Series, CS95-8, Q408		8" (203mm)	12 $\frac{3}{4}$ " (323.85mm)
VP161A-R4	73-8(E1)		193-8, SE161-R(R6), 193-8(-6)		4" (102mm)	10 $\frac{3}{4}$ " (273.05mm)
VP161A-R8	73-8(E1)		193-8, SE161-R(R6), 193-8(-6)		8" (203mm)	10 $\frac{3}{4}$ " (273.05mm)
VP410-S			(standard E.O. box)	1480	8" (203mm)	10" (254mm)

51-4



Features

- Designed for 4" Speakers
- Economical Steel Baffle
- Attractive White Finish
- Popular Design Mounts to a Wide Selection of Enclosures or Mounting Rings
- Sturdy One-Piece CRS Construction Eliminates Vibration and Rattle

Specification

Diameter	7 ³ / ₈ " (187mm)
Projection	1/4" (6.35mm)
Safety Listing	UL1480

51-8



Features

- Designed for 8" Speakers
- Economical Steel Baffle
- Attractive White Finish
- Popular Design Mounts to a Wide Selection of Enclosures or Mounting Rings
- Sturdy One-Piece CRS Construction Eliminates Vibration and Rattle

Specification

Diameter	12 ³ / ₄ " (324mm)
Projection	1/4" (6.35mm)
Safety Listing	UL1480

60-8



Features

- Designed for 8" Speakers
- Companion Enclosures or Mounting Rings are Available for Loudspeaker Installations With or Without a Tile Bridge
- Industry Standard Design with Years of Proven Performance
- Satin Aluminum Finish

Specification

Diameter	11 ¹ / ₄ " (286mm)
Projection	1/4" (6.35mm)
Safety Listing	UL1480

60-8W



Features

- Designed for 8" Speakers
- Attractive, Weather-Resistant Aluminum Construction
- Companion Enclosures or Mounting Rings are Available for Loudspeaker Installations With Or Without a Tile Bridge
- Industry Standard Design with Years of Proven Performance
- Textured White Finish

Specification

Diameter	12 $\frac{3}{4}$ " (324mm)
Projection	$\frac{1}{4}$ " (6.35mm)
Safety Listing	UL1480

61-8W



Features

- Steel Baffle Designed for 8" Speakers
- Companion Enclosures or Mounting Rings Are Available for Loudspeaker Installations With or Without a Tile Bridge
- Industry Standard Design with Years of Proven Performance
- Textured White Finish
- Sturdy Two-Piece CRS Construction

Specification

Diameter	12 $\frac{3}{4}$ " (324mm)
Projection	$\frac{1}{4}$ " (6.35mm)

61-12W



Features

- Steel Baffle Designed for 12" Speakers
- Companion Enclosures or Mounting Rings Are Available for Loudspeaker Installations With or Without a Tile Bridge
- Concealed Loudspeaker Mounting Studs Present a Clean Appearance
- Finished in Textured White
- Sturdy Two-Piece CRS Construction

Specification

Diameter	17 $\frac{1}{4}$ " (438mm)
Projection	$\frac{1}{4}$ " (6.35mm)

62-8



Features

- Steel Baffle Designed for 8" Speakers
- Companion Enclosures or Mounting Rings Are Available for Loudspeaker Installations With or Without a Tile Bridge
- Concealed Loudspeaker Mounting Studs Present a Clean Appearance
- Finished in Textured White
- Sturdy One-Piece 12-Gauge CRS Construction

Specification

Diameter	12¾" (324mm)
Projection	¼" (6.35mm)

P900



Features

- Designed for 8" Speakers
- Accommodates a Wide Variety of Atlas Sound Mounting Rings or Enclosures
- Louvered Design Provides Superior Dispersion
- Molded From Attractive and Durable Polystyrene Plastic

Specification

Diameter	12¾" (324mm)
Projection	¼" (6.35mm)

M222W



Features

- Designed for 8" Speakers
- Attractive, Weather-Resistant Contoured Aluminum Construction
- Companion Enclosures or Mounting Rings Are Available for Loudspeaker Installations With or Without a Tile Bridge
- Industry Standard Design With Years of Proven Performance

Specification

Diameter	12¾" (324mm)
Projection	¼" (6.35mm)

161-4

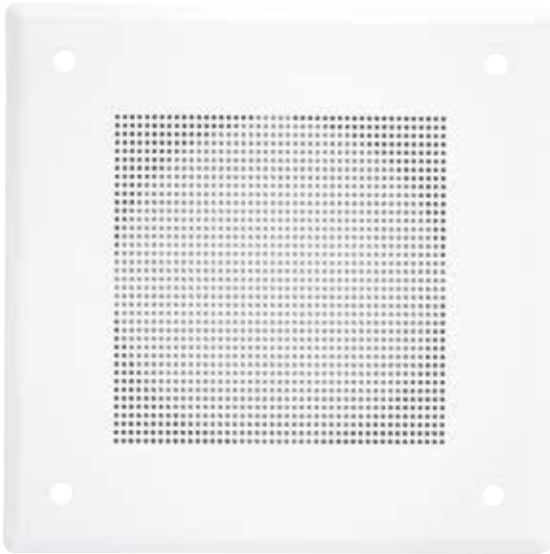

Features

- Contemporary Wall or Ceiling Baffle for 4" Speakers
- Attractive Model Feature Concealed Loudspeaker Mounting Studs
- Heavy-Gauge CRS Construction Guards Against Vibration and Rattle
- Suitable for Multi-Purpose Ceiling and Wall-Mount Applications

Specification

Height	7" (178mm)
Width	7" (178mm)
Projection	3/16" (3.96mm)
Safety Listed	UL1480

161-8

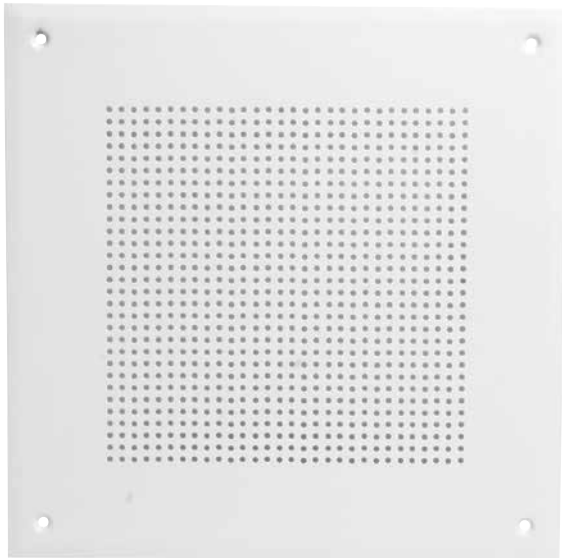

Features

- Contemporary Wall or Ceiling Baffle for 8" Speakers
- Attractive Model Feature Concealed Loudspeaker Mounting Studs
- Heavy-Gauge CRS Construction Guards Against Vibration and Rattle
- Suitable for Multi-Purpose Ceiling and Wall-Mount Applications

Specification

Height	11 1/2" (292mm)
Width	11 1/2" (292mm)
Projection	1/4" (6.35mm)
Safety Listed	UL1480

164-8A

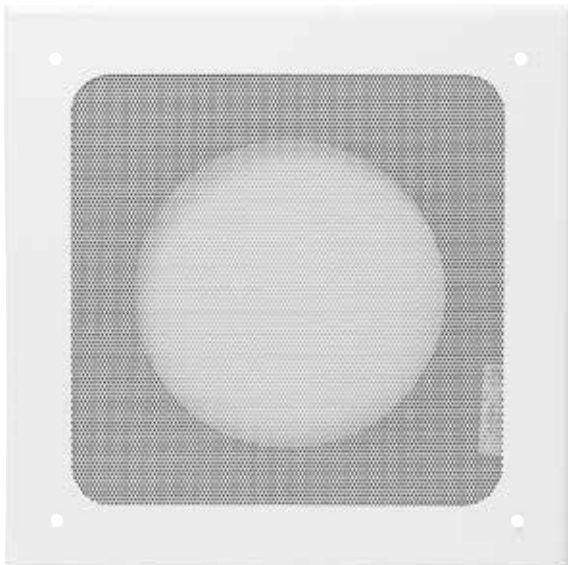

Features

- Deluxe Steel Baffle Designed for 8" Speakers
- Finished in Textured White Epoxy
- Includes Attractive Beveled Edge Featuring a Square Loudspeaker Cutout
- Large Perforations in The Protective Screen Simplify Repainting
- Separate Loudspeaker Mounting Plate Provides for Extended, "No Leak" Bass Response

Specification

Height	12 5/8" (321mm)
Width	12 5/8" (321mm)
Projection	1/4" (6.35mm)

164-8A-052



Features

- Deluxe Steel Baffle Designed for 8" Speakers
- Finished in Textured White Epoxy
- Includes Attractive Beveled Edge Featuring a Square Loudspeaker Cutout
- Large Perforations in The Protective Screen Simplify Repainting
- Separate Loudspeaker Mounting Plate Provides for Extended, "No Leak" Bass Response

Specification

Height	12 $\frac{5}{8}$ " (321mm)
Width	12 $\frac{5}{8}$ " (321mm)
Projection	$\frac{1}{4}$ " (6.35mm)

164-12A



Features

- Deluxe Steel Baffle Designed for 12" Speakers
- Attractive Beveled Edge Baffle Features a Square Loudspeaker Cutout
- Finished in Textured White Epoxy
- Large Perforations in the Protective Screen Simplify Repainting
- Separate Loudspeaker Mounting Plate Provides for an Extended, "No Leak" Bass Response

Specification

Height	16" (406mm)
Width	16" (406mm)
Projection	$\frac{1}{2}$ " (12.7mm)

164-12A-052



Features

- Deluxe Steel Baffle Designed for 12" Speakers
- Attractive Beveled Edge Baffle Features a Square Loudspeaker Cutout
- Finished in Black
- Large Perforations in The Protective Screen Simplify Repainting
- Separate Loudspeaker Mounting Plate Provides for an Extended, "No Leak" Bass Response

Specification

Height	16" (406mm)
Width	16" (406mm)
Projection	$\frac{1}{2}$ " (12.7mm)

164-15A



Features

- Deluxe Steel Baffle Designed for 15" Speakers
- Finished In Textured White Epoxy with a Black Loudspeaker Subplate
- Includes Attractive Beveled Edge Baffles Featuring a Square Loudspeaker Cutout
- Large Perforations in The Protective Screen Simplify Repainting
- Separate Loudspeaker Mounting Plate Provides for an Extended, "No Leak" Bass Response

Specification

Height	20 $\frac{1}{16}$ " (510mm)
Width	20 $\frac{1}{16}$ " (510mm)
Projection	$\frac{1}{2}$ " (12.7mm)

169-8

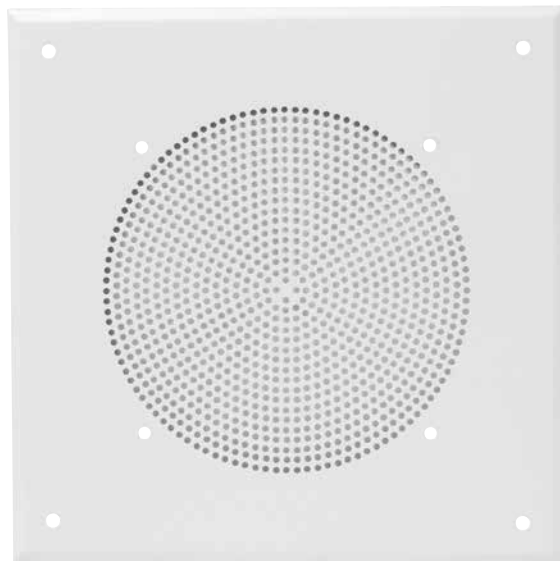

Features

- Economical Wall or Ceiling Baffle for 8" Speakers
- Heavy-Gauge CRS Construction Guards Against Vibration and Rattle
- Multi-Purpose Model Suitable for Recessed Ceiling and Recessed Wall Mount Installations

Specification

Height	10 $\frac{1}{2}$ " (267mm)
Width	10 $\frac{1}{2}$ " (267mm)
Projection	$\frac{1}{16}$ " (1.58mm)

170-8A



Features

- Perforated Baffle for 8" Speakers
- Attractive Model Feature Concealed Loudspeaker Mounting Studs
- Heavy-Gauge CRS Construction Guards Against Vibration and Rattle
- Suitable for Multi-Purpose Ceiling and Wall-Mount Applications

Specification

Height	13 $\frac{1}{2}$ " (343mm)
Width	13 $\frac{1}{2}$ " (343mm)
Projection	$\frac{1}{4}$ " (6.35 mm)
Safety Listed	UL1480 & UL2043

830-89A

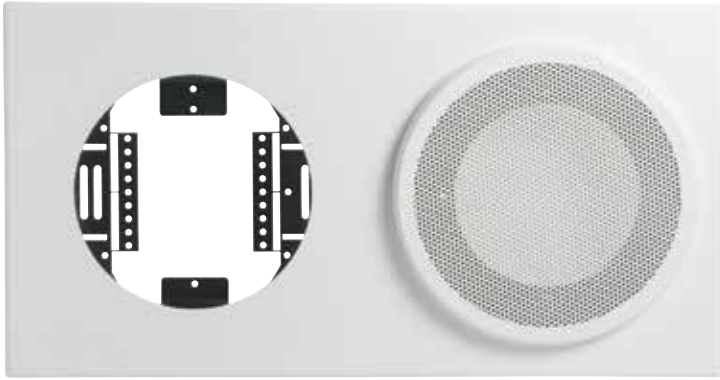

Features

- Baffle for 8" Speaker and 8" or 9" Analog Clock
- Can be Recessed or Surface Mounted Using 194 Series Enclosures
- Mounts Into Position Using A Double-Action Torsion Spring System to Provide a Hardware-Free Appearance
- Panel, Grille, and Trim Ring Components are Finished in a White Epoxy

Specification

Height	14" (356mm)
Width	26½" (673mm)
Compatible Enclosures	194-89 & SM194-89

830-812A

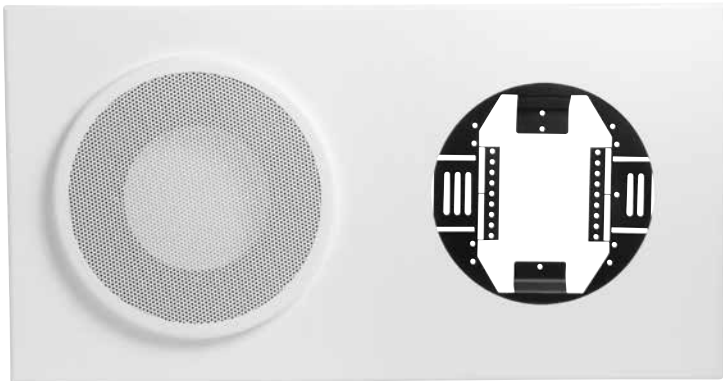

Features

- Baffle for 8" Speaker and 12" Analog Clock
- Can be Recessed or Surface Mounted Using 194 Series Enclosures
- Mounts Into Position Using A Double-Action Torsion Spring System to Provide a Hardware-Free Appearance
- Panel, Grille, and Trim Ring Components are Finished in a White Epoxy

Specification

Height	17⅞" (454mm)
Width	33⅞" (860mm)
Compatible Enclosures	194-812 & SM194-812

840-89A

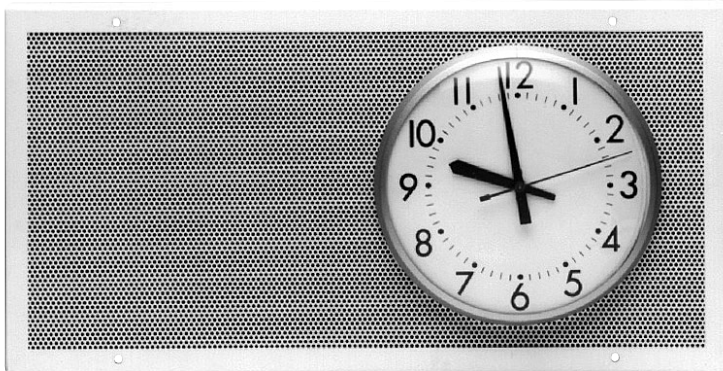

Features

- Perforated Baffle for 8" Speaker and 8" or 9" Analog Clock
- Can be Recessed or Surface Mounted Using 195 Series Enclosures
- Mounts Into Position Using a Double-Action Torsion Spring System to Provide a Hardware-Free Appearance
- Panel, Grille, and Trim Ring Components are Finished in a White Epoxy
- Clock Sold Separately

Specification

Height	13 ¹ / ₁₆ " (348mm)
Width	26¾" (680mm)
Clock Hole Size	8¾" (222mm)
Compatible Enclosures	195-89 & SM195-89

840-812A

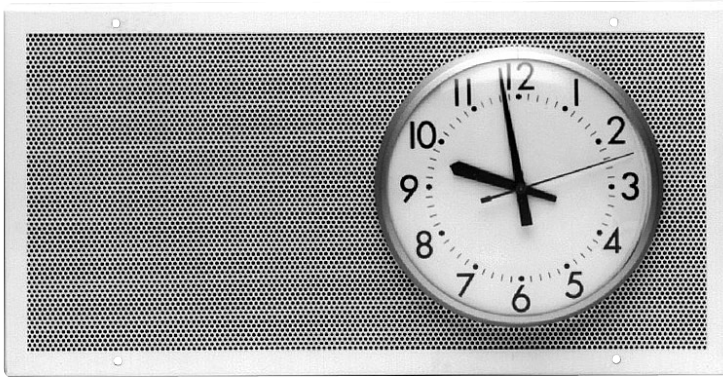

Features

- Perforated Baffle for 8" Speaker and 12" Analog Clock
- Can be Recessed or Surface Mounted Using 195 Series Enclosures
- Mounts Into Position Using a Double-Action Torsion Spring System to Provide a Hardware-Free Appearance
- Panel, Grille, and Trim Ring Components are Finished in a White Epoxy
- Clock Sold Separately

Specification

Height	18 $\frac{1}{16}$ " (459mm)
Width	33 $\frac{15}{16}$ " (862mm)
Clock Hole Size	10 $\frac{1}{2}$ " (268mm)
Compatible Enclosures	195-812 & SM195-812

T51-4



Features

- Economical Torsion Baffle for 4" Speakers
- Industry-Standard Design
- Popular Design Mounts to a Wide Selection of Enclosures or Mounting Rings
- Sturdy One-Piece CRS Construction Eliminates Vibration and Rattle
- Torsion Springs Provide Quick and Efficient Installation

Specification

Diameter	7 $\frac{3}{8}$ " (187mm)
Projection	$\frac{1}{4}$ " (6.35mm)
Compatible Enclosures	E410(-11), E410NK, EZE410

T51-84



Features

- Blind Mount Enclosure Baffle for 4" Speakers
- Economical Industry-Standard Design
- Popular Design Mounts to a Wide Selection of Enclosures or Mounting Rings
- Sturdy One-Piece Crs Construction Eliminates Vibration and Rattle
- Torsion Springs Provide Quick and Efficient Installation

Specification

Diameter	8 $\frac{1}{2}$ " (216mm)
Projection	$\frac{3}{16}$ " (4.77mm)
Compatible Enclosures	BMT95-4(-7)

T51-8



Features

- Economical Torsion Baffle for 8" Torsion Speakers
- Industry-Standard Design
- Popular Design Mounts to a Wide Selection of Enclosures or Mounting Rings
- Sturdy One-Piece CRS Construction Eliminates Vibration and Rattle
- Torsion Springs Provide Quick and Efficient Installation

Specification

Diameter	12 3/4" (324mm)
Projection	1/4" (6.35mm)
Compatible Enclosures	T95-8, EZ95-8, BMT95-8(-7)
Safety Listing	UL1480

T61-8W



Features

- Decorative Torsion Baffle for 8" Speakers
- Companion Enclosures or Mounting Rings are Available for Loudspeaker Installations With or Without a Tile Bridge
- Concealed Loudspeaker Mounting Studs Present a Clean Appearance
- Finished in Textured White
- Torsion Springs Provide Quick and Efficient Installation

Specification

Diameter	12 3/4" (323.85mm)
Projection	1/4" (6.35mm)
Compatible Enclosures	T95-8, EZ95-8, BMT95-8(-7)
Safety Listing	UL1480

T62-8



Features

- General Purpose Torsion Baffle for 8" Torsion Speakers
- Industry-Standard Design
- Popular Design Mounts to a Wide Selection of Enclosures or Mounting Rings
- Sturdy One-Piece CRS Construction Eliminates Vibration and Rattle
- Torsion Springs Provide Quick and Efficient Installation

Specification

Diameter	12 3/4" (324mm)
Projection	1/4" (6.35mm)
Compatible Enclosures	T95-8, EZ95-8, BMT95-8(-7), Q408, 96-8
Safety Listing	UL1480

T720-4



Features

- Sculptured Concealed Mounting 4" Torsion Baffle
- Attractive Textured White Epoxy Finish
- Baffle Include Provisions to Accommodate Ceiling Depths Up to 2" (50.8mm) Deep
- Specifically Designed for Quick, Efficient, and Economical Recessed Installation of 4" (101.6mm) Loudspeakers
- Torsion Springs Provide Quick and Efficient Installation
- Welded CRS Construction Eliminates Vibration and Rattle

Specification

Diameter	7 $\frac{3}{8}$ " (188mm)
Projection	$\frac{1}{16}$ " (14.3mm)
Compatible Enclosures	(EZ)E410 Series

T720-4BT



Features

- Sculptured Concealed Mounting 4" Torsion Baffle For Blind Mount Enclosure
- Attractive Textured White Epoxy Finish
- Baffle Include Provisions to Accommodate Ceiling Depths Up to 2" (50.8mm) Deep
- Specifically Designed for Quick, Efficient, and Economical Recessed Installation of 4" (101.6mm) Loudspeakers
- Torsion Springs Provide Quick and Efficient Installation
- Welded CRS Construction Eliminates Vibration and Rattle

Specification

Diameter	8 $\frac{1}{2}$ " (215.9mm)
Projection	$\frac{1}{16}$ " (14.3mm)
Compatible Enclosures	(EZ)E410 Series, BMT95-4(-7)

T720-8A



Features

- Sculptured Concealed Mounting 8" Torsion Baffle
- Specifically Designed for Quick, Efficient, and Economical Recessed Installation of 8" (203mm) Loudspeakers
- Textured White Finish
- Torsion Springs Provide Quick and Efficient Installation
- Welded CRS Construction Eliminates Vibration and Rattle

Specification

Diameter	12" (305mm)
Projection	$\frac{1}{4}$ " (6.35mm)
Compatible Enclosures	T95-8 Series, EZ95-8, BMT95-8(-7)

VP60R



Features

- Recessed Circular Vandal Proof Baffle For 8" Loudspeaker
- Meets Varying Application and Aesthetic Requirements
- Special Aluminum Alloy Construction Provides Twice the Strength of Conventional Cast Aluminum Baffles
- Tamperproof Protection for Cone Loudspeakers and Re-Entrant Horns

Specification

Diameter	12 $\frac{3}{4}$ " (324mm)
Projection	1" (25.4mm)
Safety Listing	UL1480

VP161A-R4



Features

- Recessed Vandal Proof Baffle for 4" Cone Loud Speakers
- Cast Aluminum Frame
- Neoprene Gasket
- New Stainless Surface Mount and Flush Mount Enclosures in Process
- Perforated Metal Changed to Stainless Steel
- Stainless Steel Studs to Hold Speaker

Specification

Height	10 $\frac{3}{4}$ " (273mm)
Width	10 $\frac{3}{4}$ " (273mm)
Projection	$\frac{3}{4}$ " (19.05mm)

VP161A-R8



Features

- Recessed Vandal Proof Baffle for 8" Cone Loud Speakers
- Cast Aluminum Frame
- Neoprene Gasket
- New Stainless Surface Mount and Flush Mount Enclosures in Process
- Perforated Metal Changed to Stainless Steel
- Stainless Steel Studs to Hold Speaker
- Tamperproof Protection for 4" Cone Loudspeakers

Specification

Height	10 $\frac{3}{4}$ " (273mm)
Width	10 $\frac{3}{4}$ " (273mm)
Depth	$\frac{3}{4}$ " (19.05mm)

410-4



Features

- Uni-Directional Model for 4" Speakers
- Compact Aluminum Baffle for Wall or Ceiling Use
- Attractive, Non-Rusting Aluminum Construction
- Ideal for Corridor Applications Where Surface Mounting Space is Limited

Specification

Diameter	6" (152mm)
Depth	4¼" (108mm)

510-4



Features

- Cylindrical Bi-Directional Baffle/Enclosure for 4" Speakers
- Compact Aluminum Baffle for Wall or Ceiling Use
- Attractive, Non-Rusting Aluminum Construction
- Ideal for Corridor Applications Where Surface Mounting Space is Limited

Specification

Diameter	6" (152mm)
Depth	4¾" (121mm)

VP410-S



Features

- Cylindrical Vandal Proof Enclosure for 8" Speakers
- Suitable for Wall and Ceiling Surface-Mount Installations
- Vandal-Proof Construction Protects Enclosed 8" (203.2mm) Loudspeaker or Re-Entrant Horn From Damage Or Tampering
- Works Only With the APF-15 8Ω Horn, Not Compatible With APF-15T Transformer Version Due to Height Constraints

Specification

Diameter	10" (254mm)
Depth	7" (178mm)
Safety Listing	UL1480



Atlas Sound speaker enclosures can be deployed in a variety of situations with different speakers and baffles to accommodate the needs of any size or style installation.



Enclosures Help Enhance the Low Frequency Reproduction of Speaker in Open Spaces

Enclosures

Applications

Atlas Sound speaker enclosures can be with speakers mounted in drop tile ceilings as well as surface mount applications. Atlas Sound enclosures can be used with Atlas speakers and baffles to form complete solutions that meet the needs of installations in commercial, industrial, institutional, educational, and retail facilities.

Features

- Steel Construction
- Models with Fiberglass Dampening Material Available
- Ceiling and Surface Mount Models Available

General Description

Atlas Sound makes several enclosure styles designed to be used with both 4" and 8" speaker sizes. Models are constructed using cold rolled steel designed to provide long-term durability. Enclosure models are available in varying depths to accommodate a range of speakers and to improve the low frequency reproduction of the installed speaker in a given space. Models are available with conduit knockouts and without to give integrators an option based on installation requirements. Additionally, Atlas offers enclosures specifically designed for use with IP speakers. These enclosures are available in flush mount, surface mount, and angled mount configurations as needed, and are constructed using 20-gauge cold rolled steel.

EZ Series enclosures feature the EZ Mount Support System (Patent # 4,484,658) are available on Atlas Sound's most popular 4" and 8" round enclosures. It also accommodates the same wide selection of baffles to meet your specifications and to provide inventory flexibility (refer to chart on back). The EZ Mount Enclosure/RailSystem transfers the composite weight of the loudspeaker, baffle, and enclosure to the ceiling's support members via adjustable support rails (included). The rails may be adjusted vertically and then secured to the specially designed, pre-mounted enclosure brackets with screws (furnished). No tile bridge or time-consuming screw mounting is necessary. Enclosure models EZ96-4, EZ96-4X, and EZE410 accommodate standard 4" loudspeakers. Models EZ95-8, EZ96-8, and EZ195-8 accommodate standard 8" loudspeakers. These welded, heavy-gauge CRS enclosures are finished in a textured black epoxy and undercoated to prevent mechanical and acoustical resonances. All units are equipped with conduit knockouts. The support rails are also heavy-gauge CRS and finished in a galvanized coating.

Atlas "Q" series enclosures incorporate a unique acoustical fiber board permanently attached to the inner walls of the enclosure, effectively eliminating the "hangover" and vibration normally associated with large metal enclosures. To achieve additional rigidity, unique ribs are formed on the backside of the enclosure. In addition, the inner walls are lined with 1½" (38mm) thick fiberglass with a 1½ lb/cu ft density to control unwanted resonances in the high end of the frequency spectrum. The "Q" Series enclosures are constructed of 18-gauge cold rolled steel. Compound ½" - ¾" (13mm-19mm) knockouts are furnished on all four sides. The front mounting panel of the enclosure is constructed of sturdy 18-gauge steel and incorporates the baffle mounting plaster ring. This panel is isolated by means of a foam gasket to prevent metal-to-metal contact. Two sets of slotted mounting tabs are welded on parallel sides to accept the entire metal enclosure. The Q Series models are finished in black textured epoxy.



95-8



Features

- Recessed Round Enclosure for 8" Speakers
- Industry's Most Popular Enclosure to Fulfill a Wide Variety of Installation and Application Requirements
- Welded CRS Construction With a Painted Finish, Undercoating, and Patch-Jute Lining to Eliminate Mechanical and Acoustical Resonances

Specification

Depth	4¼" (108mm)
Diameter	11¾" (298mm)
Mounts Baffle	51-8, 60-8(W), 61-8W, 62-8, 170-8A, M222W, P900, VP60-R
Safety Listing	UL1480 & UL2043

95-8-7



Features

- 8" Recessed Round Enclosure, 7" Deep w/Fiberglass
- Generous Acoustic Fiberglass Lining Improves Low Frequency Response to Achieve Fuller, Richer Bass
- Round, Recessed, Model Meets Professional Sound Installation Requirements
- Works With a Variety of Screw Mount Baffles

Specification

Depth	7" (17.8mm)
Diameter	11¾" (298mm)
Mounts Baffle	(T)51-8, (T)60-8(W), (T)61-8(W), (T)62-8, 170-8A, T720-8A, M222(W), P900, VP60-R
Safety Listing	UL1480

95-8-10



Features

- 8" Recessed Round Enclosure 10" Deep W/Fiberglass
- Generous Acoustic Fiberglass Lining Improves Low Frequency Response to Achieve Fuller, Richer Bass
- Round, Recessed, Meets Professional Sound Installation Requirements
- Works With a Variety of Screw Mount Baffles

Specification

Depth	10" (254mm)
Diameter	11¾" (302mm)
Mounts Baffle	(T)51-8, (T)60-8(W), (T)61-8(W), (T)62-8, 170-8A, T720-8A, M222(W), P900, VP60-R
Safety Listing	UL1480

95-12



Features

- 12" Recessed Round Enclosure Speakers
- Industry's Most Popular Enclosure to Fulfill a Wide Variety of Installation and Application Requirements
- Welded CRS Construction With a Painted Finish, Undercoating, and Patch-Jute Lining to Eliminate Mechanical and Acoustical Resonances

Specification

Depth	7" (178mm)
Diameter	15½" (394mm)
Mounts Baffle	61-12W

96-4



Features

- 4" Flanged Enclosure
- Compact Recessed Enclosure With Conduit Knockouts
- Constructed of 22 Gauge CRS, Undercoated, and Finished in Black Epoxy
- Provides Easy and Cost-Effective Installation of Round Screw-Mount Grilles

Specification

Depth	4¼" (108mm)
Diameter	6¼" (159mm)
Mounts Baffle	51-4
Safety Listing	UL1480

96-4X



Features

- 4" Flanged Extra Deep Enclosure
- Compact Recessed Enclosure With Conduit Knockouts
- Constructed of 22 Gauge CRS, Undercoated, and Finished in Black Epoxy
- Provides Easy and Cost-Effective Installation of Round Screw-Mount Grilles

Specification

Depth	4¼" (108mm)
Diameter	6¼" (159mm)
Mounts Baffle	51-4
Safety Listing	UL1480

96-8



Features

- 8" Flanged Round Enclosure
- Cost-Efficient Cylindrical Protective Enclosures That Mount A Variety of Atlas Sound Grilles
- Mounting Holes Located on the Internal Plaster Flange to Allow Easy and Convenient Installation

Specification

Depth	4 1/4" (108mm)
Diameter	11 7/8" (302mm)
Mounts Baffle	51-8, 60-8(W), 61-8W, 62-8, 170-8A, M222(W), P900, VP-60R
Safety Listing	UL1480 & UL2043

96-8-7



Features

- 8" Flanged Round Enclosure 7" Deep w/Fiberglass
- Generous Acoustic Fiberglass Lining Improves Low Frequency Response to Achieve Fuller, Richer Bass
- Loudspeaker Enclosures With Greater Cubic Capacity Provide Improved Loading to Enhance High-Quality Sound Systems
- Mounting Holes Located on the Internal Plaster Flange to Allow Easy and Convenient Installation
- Round, Recessed, Model to Meet Professional Sound Installation Requirements

Specification

Depth	7" (178mm)
Diameter	11 7/8" (302mm)
Mounts Baffle	51-8, 60-8(W), 61-8W, 62-8, 170-8A, M222(W), P900, VP-60R
Safety Listing	UL1480

96-8-10



Features

- 8" Flanged Round Enclosure 10" Deep w/Fiberglass
- Generous Acoustic Fiberglass Lining Improves Low Frequency Response to Achieve Fuller, Richer Bass
- Loudspeaker Enclosures With Greater Cubic Capacity Provide Improved Loading to Enhance High-Quality Sound Systems
- Round, Recessed, Model to Meet Professional Sound Installation Requirements

Specification

Depth	10" (254mm)
Diameter	11 7/8" (302mm)
Mounts Baffle	51-8, 60-8(W), 61-8W, 62-8, 170-8A, M222(W), P900, VP-60R
Safety Listing	UL1480

191-78



Features

- Enclosure with Adjustable Mounting Bracket
- Cost-Effective Assembly That Mounts a Wide Variety of Atlas Sound Grilles
- Square, Recessed, Mounting Model Meets Professional Sound Installation Requirements
- Welded CRS Construction, Finished in Black Enamel, and are Undercoated to Eliminate Mechanical and Acoustical Resonances
- 2 Mounting Rails Included

Specification

Height	11 ¹ / ₁₆ " (297mm)
Width	11 ¹ / ₁₆ " (297mm)
Depth	4" (101.6mm)
Safety Listing	UL1480

191-78-8



Features

- Extra Deep Enclosure with Adjustable Mounting Bracket
- Generous Acoustic Fiberglass Lining Improves Low Frequency Response to Achieve Fuller, Richer Bass
- Loudspeaker Enclosures With Greater Cubic Capacity Provide Improved Loading to Enhance High-Quality Sound Systems
- Square, Recessed, Mounting Model Meets Professional Sound Installation Requirements
- 2 Mounting Rails Included

Specification

Height	8" (203.2mm)
Width	8" (203.2mm)
Depth	11 ¹ / ₁₆ " (296.86mm)
Safety Listing	UL1480

193-8



Features

- Economical 8" Square Enclosure
- Design Includes Slotted Mounting Holes to Accept 180 Series Support Rails for Efficient Installation in Suspended Tile Ceilings
- Economical Enclosure Accommodates 8" (203mm) Diameter Loudspeakers and Standard Screw-Mount Baffle Installation
- Finished in Black Enamel

Specification

Height	9 ¹ / ₂ " (242mm)
Width	9 ¹ / ₂ " (242mm)
Depth	3 ³ / ₄ " (95.3mm)
Safety Listing	UL1480

193-8-6



Features

- 6" Deep Economical Enclosure for 8" Speaker
- Design Includes Slotted Mounting Holes to Accept 180 Series Support Rails for Efficient Installation In Suspended Tile Ceilings
- Economical Enclosure Accommodates 8" Diameter Loudspeakers and Standard Screw-Mount Baffle Installation
- Finished in Black Enamel

Specification

Height	9½" (242mm)
Width	9⅞" (243mm)
Depth	6" (152mm)

194-89



Features

- Recessed Enclosure for 830-89A
- Provisions for Easy Installation of Standard 8" Loudspeakers.
- Recessed Mounting Style Meets Installation Requirements
- Reliable Design Installs Quickly in New or Retrofit Construction

Specification

Height	12⅞" (306mm)
Width	24½" (622mm)
Depth	3" (76.2mm)
Mounts Baffle	830-89A

194-812



Features

- Recessed Enclosure for 830-812A
- Include Provisions for Easy Installation of Standard 8" (203mm) Loudspeakers
- Recessed Mounting Style Meets Installation Requirements.
- Reliable Design Installs Quickly in New or Retrofit Construction

Specification

Height	15 ⅞" (403.3mm)
Width	31⅞" (803.3mm)
Depth	3" (76.2mm)
Mounts Baffle	830-812A

195-89



Features

- Recessed Enclosure for 840-89A
- All Models Include Provisions for Easy Installation of Standard 8" Speakers
- Recessed Mounting Style Meets Installation Requirements
- Reliable Design Installs Quickly in New or Retrofit Construction

Specification

Height	11 $\frac{7}{8}$ " (301.625mm)
Width	23 $\frac{3}{4}$ " (606.425mm)
Depth	3" (76.2mm)
Mounts Baffle	840-89A

195-812



Features

- Recessed Enclosure for 840-812A
- All Models Include Provisions for Easy Installation of Standard 8" Speakers
- Recessed Mounting Style Meets Installation Requirements
- Reliable Design Installs Quickly in New or Retrofit Construction

Specification

Height	16" (406.4mm)
Width	31 $\frac{1}{4}$ " (793.75mm)
Depth	3" (76.2mm)
Mounts Baffle	840-812A

198-4

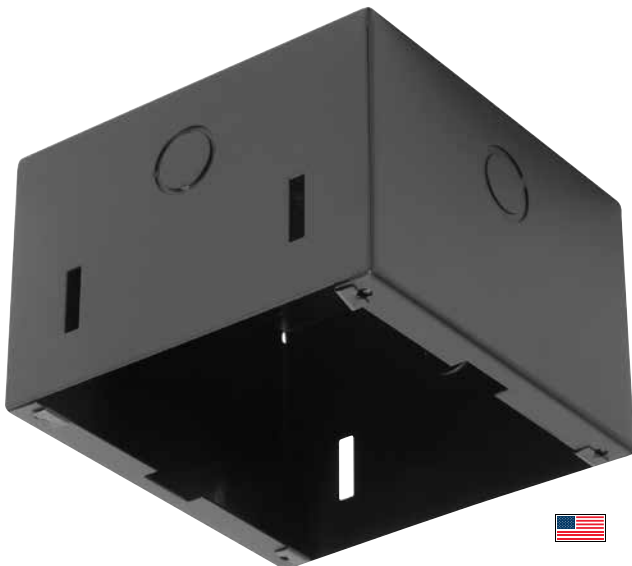

Features

- Rectangular Enclosure for 4" Loudspeakers
- Will Accommodate Standard Screw-Mount Baffles.
- Finish is Black Enamel

Specification

Height	6 $\frac{1}{4}$ " (159mm)
Width	6 $\frac{1}{4}$ " (159mm)
Depth	4 $\frac{1}{8}$ " (105mm)
Safety Listing	UL1480

198-8



Features

- Rectangular Enclosure for 8" Loudspeakers
- Designed for 8" Diameter Loudspeakers and Will Accommodate Standard Screw-Mount Baffles.
- Finish is Black Enamel

Specification

Height	10 ¹ / ₁₆ " (271mm)
Width	10 ¹ / ₁₆ " (271mm)
Depth	3 ³ / ₄ " (95.3mm)
Safety Listing	UL1480

198-8-8

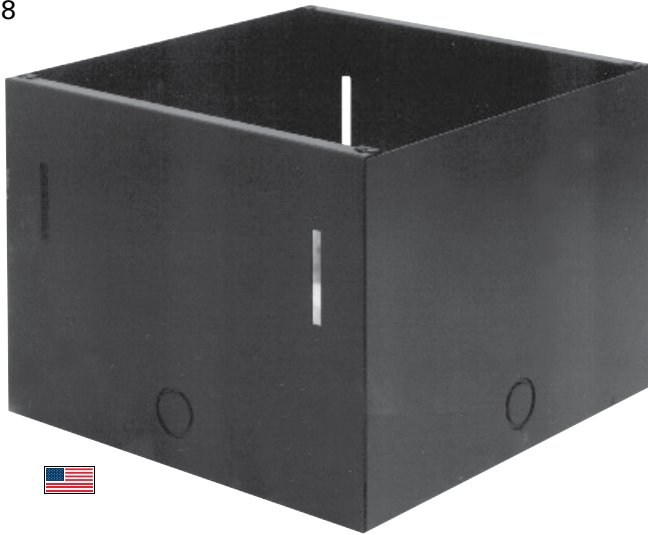

Features

- Extra Deep Rectangular Enclosure for 8" Speakers
- Generous Acoustic Fiberglass Lining Improves Low Frequency Response to Achieve Fuller, Richer Bass
- Loudspeaker Enclosures With Greater Cubic Capacity Provide Improved Loading to Enhance High-Quality Sound Systems
- Square, Mounting Model Meets Professional Sound Installation Requirements

Specification

Height	8" (203mm)
Width	8" (203mm)
Depth	10 ⁵ / ₈ " (270mm)

BMT95-4



Features

- Blind Mount 5" Deep Enclosure for 4" Speakers
- Mounting Ears Adjust Vertically to Accommodate Varying Ceiling Thicknesses
- Quick Mounting of Torsion-Spring and Surface-Mounting Loudspeaker Grilles
- Support System Enables Enclosure Installation in Retrofit Ceiling Applications

Specification

Depth	5" (127mm)
Diameter	6 ¹ / ₂ " (165mm)
Mounts Baffle	T51-84, T720-4BT, T51-4

BMT95-4-7



Features

- Blind Mount 4" Enclosure 7" Deep
- Extra-Depth Model Offers Increased Volume and Extended Bass Response
- Mounting Ears Adjust Vertically to Accommodate Varying Ceiling Thicknesses
- Quick Mounting of Torsion-Spring and Surface-Mounting Loudspeaker Grilles
- Support System Enables Enclosure Installation in Retrofit Ceiling Applications

Specification

Depth	7" (177.8mm)
Diameter	6½" (165.1mm)
Mounts Baffle	T51-84, T720-4BT, T51-4

BMT95-8



Features

- Blind Mount 8" Enclosure 5" Deep
- Mounting Ears Adjust Vertically to Accommodate Varying Ceiling Thicknesses
- Quick Mounting of Torsion-Spring and Surface-Mounting Loudspeaker Grilles
- Support System Enables Enclosure Installation in Retrofit Ceiling Applications

Specification

Depth	4½" (114mm)
Diameter	10⅞" (257mm)
Mounts Baffle	(51-8, 60-8(W), 61-8W, 62-8, 170-8A, M222(W), P900, VP-60R)

BMT95-8-7



Features

- Blind Mount 8" Enclosure 7" Deep
- Extra-Depth Model Offers Increased Volume and Extended Bass Response
- Mounting Ears Adjust Vertically to Accommodate Varying Ceiling Thicknesses
- Quick Mounting of Torsion-Spring and Surface-Mounting Loudspeaker Grilles
- Support System Enables Enclosure Installation in Retrofit Ceiling Applications

Specification

Depth	7" (178mm)
Diameter	10⅞" (257mm)
Mounts Baffle	51-8, 60-8(W), 61-8W, 62-8, 170-8A, M222(W), P900, VP-60R

CS95-8



Features

- 8" Recessed Round Stacking Enclosure
- Cost Effective Enclosure System for General Use
- Perfect for SD72W, SD722W, or DLS4
- Stackable for Easy Storage

Specification

Depth	4¼" (107.95mm)
Diameter	11¾" (298.5mm)
Mounts Baffle	51-8, 60-8(W), 61-8W, 62-8, 170-8A, M222(W), P900, VP-60R
Safety Listing	UL1480

E410



Features

- Torsion Mount 4" Enclosure 6.5" Deep
- Equipped With Receptacles for Easy Installation of Torsion Spring Grilles
- Includes Conduit Knockouts
- Standard-Volume Model

Specification

Depth	6½" (165.1mm)
Diameter	10⅞" (257.2mm)
Mounts Baffle	T51-4, T720-4(BT)
Safety Listing	UL1480

E410NK



Features

- Torsion Mount 4" Enclosure 6.5" Deep No Knockouts
- Equipped With Receptacles for Easy Installation of Torsion Spring Grilles
- Standard-Volume Model
- Without Conduit Knockouts

Specification

Depth	6½" (165mm)
Diameter	10⅞" (257mm)
Mounts Baffle	T51-4, T720-4(BT)
Safety Listing	UL1480

E410NK-11



Features

- Equipped With Receptacles for Easy Installation of Torsion Spring Grilles
- High-Volume Model Provides Extended Bass Response
- No Knockouts
- Perfect for Use With FA134 and FC104 Loudspeakers

Specification

Depth	11" (279mm)
Diameter	10 $\frac{1}{8}$ " (257mm)
Mounts Baffle	T51-4, T720-4(BT)

EZ95-8



Features

- EZ Mount Recessed Enclosure for 8" Speakers
- Accommodates a Wide Selection of Atlas Sound Baffles
- Eliminates the Need for Tile Bridges and Time-Consuming Screw Mounting
- Patented Enclosure/Rail System Installs Easily to Provide Time and Labor Saving

Specification

Depth	4 $\frac{1}{4}$ " (108mm)
Diameter	9 $\frac{7}{8}$ " (251mm)
Mounts Baffle	51-8, 60-8(W), 61-8(W), 62-8, 170-8A, M222(W), P900, VP-60R

EZ96-4



Features

- EZ Mount Flanged Enclosure for 4" Speaker
- Accommodates a Wide Selection of Atlas Sound Baffles
- Eliminates the Need for Tile Bridges and Time-Consuming Screw Mounting
- Patented Enclosure/Rail System Installs Easily to Provide Time and Labor Saving

Specification

Depth	4 $\frac{1}{4}$ " (108mm)
Diameter	5 $\frac{1}{8}$ " (130.2mm)
Mounts Baffle	51-4, 60-4
Safety Listing	UL1480

EZ96-4X



Features

- EZ Mount Flanged, Extra Deep Enclosure for 4" Speaker
- Accommodates a Wide Selection of Atlas Sound Baffles
- Eliminates the Need for Tile Bridges and Time-Consuming Screw Mounting
- Offered for Suspended Ceiling Applications
- Patented Enclosure/Rail System Installs Easily to Provide Time and Labor Savings

Specification

Depth	6" (152.4mm)
Diameter	5½" (130.1mm)
Mounts Baffle	51-4
Safety Listing	UL1480

EZ96-8



Features

- EZ Mount Flanged Enclosure for 8" Speaker
- Accommodates a Wide Selection of Atlas Sound Baffles
- Eliminates the Need for Tile Bridges and Time-Consuming Screw Mounting
- Patented Enclosure/Rail System Installs Easily to Provide Time and Labor Saving

Specification

Depth	4¼" (108mm)
Diameter	10¾" (273.1mm)
Mounts Baffle	51-8, 60-8(W), 61-8W, 62-8, 170-8A, M222(W), P900, VP-60R

EZ195-8



Features

- EZ Mount Flanged Torsion Enclosure for 8" Speaker
- Accommodates a Wide Selection of Atlas Sound Baffles
- Eliminates the Need for Tile Bridges and Time-Consuming Screw Mounting
- Offered for Suspended Ceiling Applications
- Patented Enclosure/Rail System Installs Easily to Provide Time and Labor Savings

Specification

Depth	5½" (139mm)
Diameter	10½" (257mm)
Mounts Baffle	T62-8, T51-8

EZE410



Features

- EZ Torsion Mount Enclosure for 4" Speaker
- Accommodates a Wide Selection of Atlas Sound Baffles
- Eliminates the Need for Tile Bridges and Time-Consuming Screw Mounting
- Patented Enclosure/Rail System Installs Easily to Provide Time and Labor Savings

Specification

Depth	6" (152.4mm)
Diameter	6 $\frac{3}{8}$ " (162mm)
Mounts Baffle	T51-4, T720-4(BT)

Q408



Features

- Q Series 1 Cubic Ft Cylindrical Enclosure with Undercoating for 8" Speaker
- 1 Cubic Foot Capacity - Matches Well With 8CxT60 And FA138 Drivers
- Works Well With 81-8R Tile Bridge and 62-8 Baffle for Acoustic Tile Ceilings
- Galvanized Steel Finish

Specification

Depth	10 $\frac{1}{2}$ " (267mm)
Diameter	14 $\frac{3}{8}$ " (365mm)
Mounts Baffle	51-8, 60-8(W), VP60-R, 61-8W, 62-8, M222(W), P900
Safety Listing	UL1480

Q418



Features

- Q Series 1.5 Cubic Ft Square Enclosure for 8" Speaker
- 1.5 Cubic Foot Capacity - Matches Well With 8CXT60 and FA138 Drivers
- Requires 164-8A (White) or 164-8A-052 (Black) Baffle

Specification

Height	8" (203.2mm)
Width	18" (457.2mm)
Depth	18" (457.2mm)
Mounts Baffle	164-8A, 164-8A-052
Safety Listing	UL1480

Q428-SA



Features

- Q Series Surface Mount Square Enclosure for 8" Speaker
- 1.5 Cubic Foot Capacity - Matches Well With 8CX60 and FA138 Drivers
- Complete Q Box Assembly With Grill
- Entire Unit Finished In White
- Grille Included

Specification

Height	8½" (215.9mm)
Width	18" (457.2mm)
Depth	18" (457.2mm)
Mounts Baffle	Included

Q4412



Features

- Q Series 2 Cubic Ft Square Enclosure for 12" Speakers
- 2 Cubic Foot Capacity - Matches Well With C12BT60 Driver
- Requires 164-12A (White) or 164-12A-052 (Black) Baffle
- Fiberboard Must be Removed From the Bottom of the Enclosure to Provide Sufficient Clearance for the 12CX or 12CX60 Speakers

Specification

Height	8" (203mm)
Width	23" (584.2mm)
Depth	18" (457.2mm)
Mounts Baffle	164-12

Q4612



Features

- Q Series 3 Cubic Ft Square Enclosure for 12" Speaker
- 3 Cubic Foot Capacity - Matches Well With 12CX, 12CX60 or C12BT60 Driver
- Requires 164-12A (White) or 164-12A-052 (Black) Baffle

Specification

Height	12" (305mm)
Width	23" (584mm)
Depth	18" (457mm)
Mounts Baffle	164-12

Shown with QPLATE40 and 12CX60 Installed

Q4712



Features

- Q Series 4 Cubic Ft Square Enclosure for 12" Speakers
- 4 Cubic Foot Capacity - Matches Well With 12CX, 12CXT60 or C12BT60 Driver
- Requires 164-12A (White) or 164-12A-052 (Black) Baffle

Specification

Height	18" (457mm)
Width	23" (584mm)
Depth	16¼" (413mm)
Mounts Baffle	164-12A, 164-12A-052

Q4812



Features

- Q Series 6 Cubic Ft Square Enclosure for 12" Speakers
- 6 Cubic Foot Capacity - Matches Well With 12CX, 12CXT60 or C12BT60 Driver
- Requires 164-12A (White) or 164-12A-052 (Black) Baffle

Specification

Height	15" (381mm)
Width	29½" (749.3mm)
Depth	23" (584.2mm)
Mounts Baffle	164-12A, 164-12A-052

Q4915



Features

- Q Series 6 Cubic Ft Square Enclosure for 15" Speakers
- 6 Cubic Foot Capacity
- Requires 164-15A (White) Baffle

Specification

Height	15" (381mm)
Width	29½" (749.3mm)
Depth	23" (584.2mm)
Mounts Baffle	164-15

QS408



Features

- Q Series 1 Cubic ft Square Enclosure for 8" Speakers
- 1 Cubic Foot Capacity - Matches Well With 8CXT60 and FA138 Drivers
- Requires Baffle 164-8A (White) or Baffle 164-8A-052 (Black)

Specification

Height	15" (381mm)
Width	15" (381mm)
Depth	8" (203.2mm)
Baffle	164-8A, 164-8A-052

SE175-4



Features

- 4" Deep Surface Mount Square Enclosure for 8" Speakers
- Versatile Enclosures Mount a Variety of Torsion-Spring and Screw Mount Atlas Sound Baffles
- White Finish

Specification

Height	11 $\frac{1}{8}$ " (295.3mm)
Width	11 $\frac{1}{8}$ " (295.3mm)
Depth	4" (101.6mm)
Safety Listing	UL1480 & UL2043

SE198-4



Features

- 4.375" Deep Surface Mount Square Enclosure for 4" Speakers
- Enables Surface Installation of 4" (101.6mm) Loudspeakers
- Versatile Enclosures Mount a Variety of Torsion-Spring and Screw Mount Atlas Sound Baffles

Specification

Height	7 $\frac{1}{8}$ " (181mm)
Width	7 $\frac{1}{8}$ " (181mm)
Depth	4 $\frac{3}{8}$ " (11.125mm)

SM191-78



Features

- Deluxe 4" Deep Surface Mount Square Enclosure for 8" Speakers
- Generous Acoustic Fiberglass Lining Improves Low Frequency Response to Achieve Fuller, Richer Bass
- Mounts a Variety of Atlas Sound Square Speaker Baffles
- Surface Mounting Model Meets Professional Sound Installation Requirements

Specification

Height	12¾" (324mm)
Width	12¾" (324mm)
Depth	4" (102mm)

SM191-78-8



Features

- Deluxe 8" Deep Surface Mount Square Enclosure for 8" Speakers
- Choice of Square Surface Mounting Model Meets Professional Sound Installation Requirements
- Generous Acoustic Fiberglass Lining Improves Low Frequency Response to Achieve Fuller, Richer Bass
- Mounts a Variety of Atlas Sound Square Baffle

Specification

Height	12¾" (324mm)
Width	12¾" (324mm)
Depth	8" (20.3 mm)

SM194-89



Features

- Surface Mount Clock / Speaker Enclosure
- All Models Include Provisions for Easy Installation of Standard 8" Speakers
- Recessed and Surface Mounting Styles Meet Installation Requirements.
- Reliable Design Installs Quickly in New or Retrofit Construction

Specification

Height	14½" (359mm)
Width	26⅝" (676mm)
Depth	3" (7.62mm)
Mounts Baffle	830-89A

SM194-812



Features

- Surface Mount Clock / Speaker Enclosure
- All Models Include Provisions for Easy Installation of Standard 8" Speakers
- Recessed and Surface Mounting Styles Meet Installation Requirements.
- Reliable Design Installs Quickly in New or Retrofit Construction

Specification

Height	18" (457mm)
Width	34" (864mm)
Depth	3" (7.62mm)
Mounts Baffle	830-812A

SM195-89



Features

- Surface Mount Clock / Speaker Enclosure
- All Models Include Provisions for Easy Installation of Standard 8" Speakers
- Recessed and Surface Mounting Styles Meet Installation Requirements.
- Reliable Design Installs Quickly in New or Retrofit Construction

Specification

Height	13 ¹³ / ₁₆ " (351mm)
Width	26 ⁷ / ₈ " (683mm)
Depth	3" (7.62mm)
Mounts Baffle	840-89A

SM195-812



Features

- Surface Mount Clock / Speaker Enclosure
- All Models Include Provisions for Easy Installation of Standard 8" Speakers
- Recessed and Surface Mounting Styles Meet Installation Requirements
- Reliable Design Installs Quickly in New or Retrofit Construction

Specification

Height	18 ¹³ / ₁₆ " (478mm)
Width	34 ¹ / ₁₆ " (865mm)
Depth	3" (7.62mm)
Mounts Baffle	840-812A

T95-8-7



Features

- High Quality 7" Deep Torsion Enclosure for 8" Speakers
- Black Finish
- Generous Acoustic Fiberglass Lining Improves Low Frequency Response
- Mounts a Variety of Round Torsion Grill Assemblies

Specification

Depth	7" (177.8mm)
Diameter	11¾" (299mm)
Shipping Weight	3.80 lbs (1.72 kgs)
Mounts Baffle	51-8, 60-8(W), 61-8W, 62-8, 170-8A, M222(W), P900, VP-60R
Safety Listing	UL1480

T95-8-10



Features

- High Quality 10" Deep Torsion Enclosure for 8" Speakers
- Black Finish
- Generous Acoustic Fiberglass Lining Improves Low Frequency Response
- Mounts A Variety of Round Torsion Grill Assemblies

Specification

Depth	10" (254mm)
Diameter	11¾" (299mm)
Mounts Baffle	51-8, 60-8(W), 61-8W, 62-8, 170-8A, M222(W), P900, VP-60R
Safety Listing	UL1480 & UL2043

SEA-I8S



Features

- Angled Enclosure for IP Addressable Speaker Systems
- Specifically Designed for Optimum Performance and Installation Ease
- Works with Atlas Sound Models I8S, I8S-CK, I8SM and I8SM-CK

Specification

Height	11¾" (297mm)
Width	11¾" (298mm)
Top Depth	5" (127mm)
Bottom Depth	3" (76mm)
Safety Listing	UL60950-1

SEA-I8SC



Features

- Angled Enclosure for IP Addressable Speakers
- Specifically Designed for Optimum Performance and Installation Ease
- Works with Atlas Sound Loudspeaker System Models I8SC, I8SC-CK, I8SCM, I8SCM-CK, I8SCH, and I8SCH-CK

Specification

Height	14 $\frac{7}{16}$ " (366mm)
Width	13" (330mm)
Top Depth	5" (127mm)
Bottom Depth	2.5" (64mm)
Safety Listing	UL60950-1

SEST-IH



Features

- Straight Enclosure for IHVP(-CK) IP Addressable Speaker
- Specifically Designed for Optimum Performance and Installation Ease
- Works with Atlas Sound Loudspeaker System Models IHVP and IHVP-CK

Specification

Height	11" (279mm)
Width	11" (279mm)
Depth	6" (152mm)

SEST-I8S



Features

- Straight Enclosure for IP Addressable Speakers
- Specifically Designed for Optimum Performance and Installation Ease
- Works with Atlas Sound Models I8S, I8S-CK, I8SM and I8SM-CK

Specification

Height	11 $\frac{11}{16}$ " (295mm)
Width	11 $\frac{3}{8}$ " (294mm)
Depth	4" (102mm)
Safety Listing	UL60950-1

SEST-I8SC



Features

- Straight Enclosure for IP Addressable Speakers
- Specifically Designed for Optimum Performance and Installation Ease
- Works with Atlas Sound Loudspeaker System Models I8SC, I8SC-CK, I8SCM, I8SCM-CK, I8SCH, and I8SCH-CK

Specification

Height	14 ⁵ / ₈ " (372mm)
Width	13 ¹ / ₈ " (334mm)
Depth	4" (102mm)
Safety Listing	UL60950-1

FEST-IH



Features

- Flush Mount Enclosure for IHVP(-CK) IP Addressable Speaker
- Specifically Designed for Optimum Performance and Installation Ease
- Works with Atlas Sound Loudspeaker System Models IHVP and IHVP-CK

Specification

Height	9 ¹ / ₈ " (245mm)
Width	16 ⁵ / ₈ " (473mm) Including Wings
Depth	6" (152mm)

FEST-I8S



Features

- Flush Mount Enclosure for IP Addressable Speakers
- Specifically Designed for Optimum Performance and Installation Ease
- Works with Atlas Sound Models I8S, I8S-CK, I8SM and I8SM-CK

Specification

Height	10 ⁵ / ₈ " (270mm)
Width	10 ⁵ / ₈ " (270mm)
Depth	3 ³ / ₄ " (95mm)
Safety Listing	UL60950-1

FEST-I8SC



Features

- Flush Mount Enclosure for IP Addressable Speakers
- Specifically Designed for Optimum Performance and Installation Ease
- Works with Atlas Sound Loudspeaker System Models I8SC, I8SC-CK, I8SCM, I8SCM-CK, I8SCH, and I8SCH-CK

Specification

Height	13½" (334mm)
Width	18½" (473mm) Including Wings
Depth	4" (102mm)



Atlas Enclosures for IP Speakers Are an Integral Part of a ControKom® 2.0 Messaging System Deployed in a School



Atlas Sound BlueBridge TSD models are the most powerful and cost effective DSP units on the market today.



Houses of Worship Present Many Challenges to Quality Sound, Atlas BlueBridge DSP Offers a Comprehensive Solution To Overcome These Problems

2x2 and 4x4 DSP

Applications

The TSD-BB22 and TSD-BB44 BlueBridge DSP controllers are cost effective solutions for the most demanding applications including video conferencing, house of worship, presentation rooms, conference rooms, courtrooms, room combining, restaurants, multi-zone paging, background music, and many other sound reinforcement and AV applications.

Features

- 2x2 or 4x4 I/O Mic/Line Configurations
- Open Architecture Software for Flexibility
- Premium THAT Corp Mic Preamps
- Ethernet Network Connectivity
- Remote Control Using Optional Wall Plates
- Output Peak & Signal Indicator LED's
- Wireless Touch Panel Options

General Description

Atlas Sound BlueBridge is a DSP platform is a powerful and flexible tool that offers mission critical solutions to successfully complete any installation. Engineered to strict standards with the highest quality internal components, BlueBridge DSP solutions provide pure, clean audio, Ethernet network connectivity for cost effective TCP/IP control, and open architecture with Drag and Drop programmability. The TSD BlueBridge models have an extraordinary amount of power in a unit that is only 1RU tall and 4.75" wide. The BlueBridge platform includes multiple DSP modules including equalizers, crossovers, filters, delays, mixers, generators, meters, dynamic adjustments including compressor, expander, limiter, and ducker as well.

The Atlas TSD-BB22 and TSD-BB44 can be used in conjunction with Atlas BlueBridge wall controls and touch panels. These external devices can be reconfigured through the BlueBridge software to make adjustments to the audio from the wall control location. These items are especially useful in convention centers, hotels, office complexes, and houses of worship.

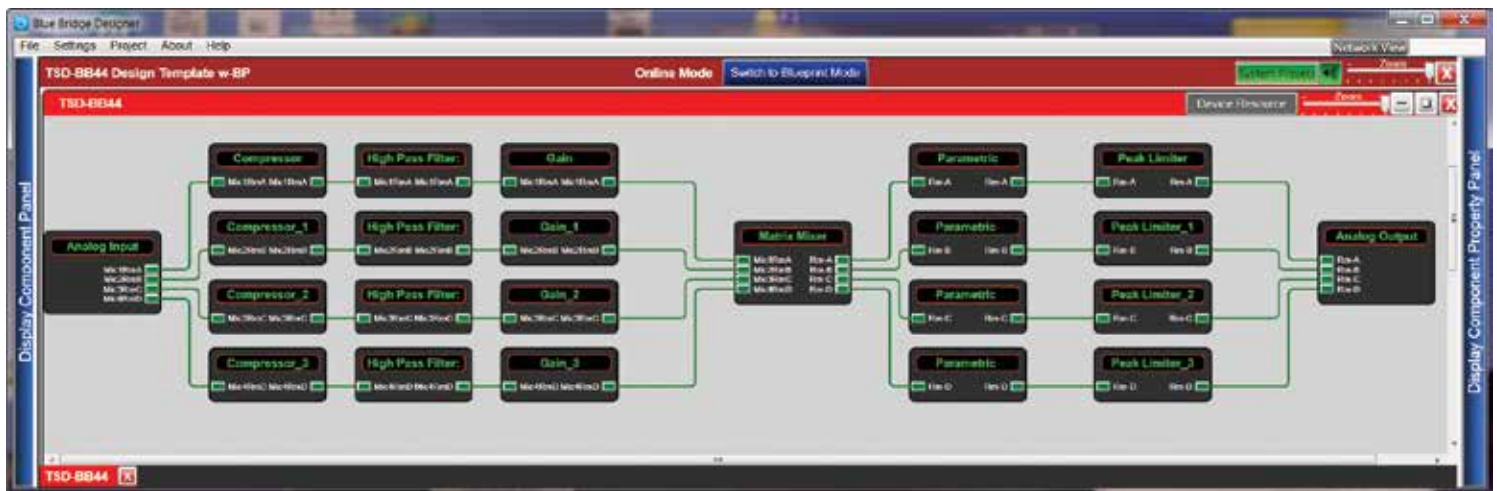

Atlas BlueBridge Software Offers a Multitude of Drag and Drop Solutions that Allow Integrators and System Designers to Deliver an Exceptional Sound Experience



TSD-BB22 / TSD-BB44

Features

- TSD-BB22 2 x 2 I/O Design
- TSD-BB44 4 x 4 I/O Design
- Drag and Drop Open Architecture Software
- Mic or Line Selectable Inputs
- Balanced High Gain Outputs
- Output Peak & Signal Indicator LEDs
- Ultra Low Noise Floor
- High Quality Mic Preamp (THAT)
- BlueBridge Compatible
- Ethernet Network Connectivity
- 24Bit Converters
- 48KHz, 40 Bit Floating DSP Engine
- External Power Supply (Included)
- Remote Control Interface via Optional Wall Plates or Device Apps
- Ethernet Network Control TCP/IP
- DSP modules Drag & Drop
- EQ Parametric, Graphic Anti Feedback
- Crossover Type Butterworth, Linkwitz Riley, Bessel, Slopes: 6 to 48dB per Octave
- Filters High Shelf, Low Shelf, All Pass
- Delay 10mS - 2 Second,
- Processing Compressor, Limiter, Expander
- Mixers Gain Sharing Auto Mixer, Matrix Mixer, Gating Auto Mixer, L & R Mixer, LCR Mixer, RMS Meters, Ducker
- Generators Sine Tone, White & Pink Noise, Sine Sweep

Specifications

Input

TSD-BB22	Two (2) Inputs
TSD-BB44	Four (4) Inputs
Type	Microphone or Line Level, Selectable
Configuration	Electronically Balanced
Gain	-40 to +15dB in 0.25dB Steps
Polarity	+/- Selectable
Connection	PHX Style, 3 Position, 3.5mm Spacing
Input Impedance	>10kΩ
Maximum Input Level	+20dBu
Phantom Power	48V, GUI Enabled

Output

Gain	-40 to +15dB in 0.25 dB Steps
Connection	PHX Style, 3 Position, 3.5mm Spacing
Output Impedance	50Ω
Maximum Output Level	+20dBu

Digital Audio Performance

Processor	40-Bit Floating Point
Sampling Rate	48kHz
Analog Converters	High Performance 24-bit
Propagation Delay	3ms

General

Frequency Response	20Hz – 20kHz (±0.1dB)
Dynamic Range	110dB type (unweighted)
CMMR	> 100dB (50 to 10kHz)
Crosstalk	< -100dB
Distortion	0.002% (1kHz @+4dBu)
Preset Programs	70
Delay Units	ms, ft, m
Power	5-12VDC External Power Supply
Dimensions	1½" (38mm) x 5½" (140mm) x 2¾" (70mm)
Chassis Color	Black
Chassis Material	Aluminum
Weight	16oz, .454kg

Safety and Certifications

With External Power Supply	cUL, CE, UL
TSD	CE, CCC Listed



TSD-BB22



TSD-BB22 Back



TSD-BB44

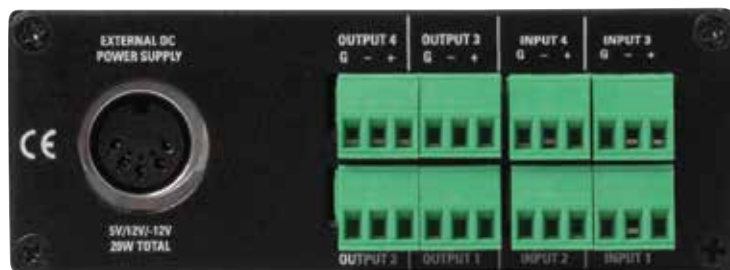

TSD-BB44 Back



Atlas Sound TSD amplifiers were developed to offer integrators a simple solution to add amplification to new or existing systems.



TSD Amplifiers Can be Used in Variety of Installations Including Resorts with Multiple Common Areas



TSD Distribution Amplifiers Can Deliver Signal Across Multiple Zones and With Varying Volume Levels

Time Saving Devices Amplifiers

Applications

TSD amplifier models can be used in a variety of installation scenarios. Their small chassis size makes them easy to add to existing rack elevations for systems that have already been installed or for systems where a client wants to add more amplification during the installation process. TSD amplifiers can also be used as an inexpensive solution to add amplification to boardrooms, conference rooms, small healthcare offices, houses of worship, or other areas where background music or paging are required.

Features

Distribution Amplifiers

- Balanced Line Input
- Isolated Balanced Line Outputs
- Front Panel Input Level Controls
- Front Panel LED Indicators
- Removable Phoenix Style I/O Connections
- Integrated Cable Management System

Power Amplifiers

- Front Panel Input Level Control
- Front Panel LED Indicators
- Removable Phoenix Style I/O Connectors
- Integrated Cable Management System

General Description

TSD distribution amplifiers can be used in a variety of installation scenarios. One scenario in which the TSD-DA13, 1 x 3 distribution amp, can be effectively deployed involves adding three balanced line level "press feeds" that each receive an isolated signal to a sound system for recording and engineering purposes but the existing house system only has one unbalanced output available. That unbalanced line level output can be connected to the input on the TSD-DA13. The positive and negative terminals on the three outputs can then be connected to the wall plate or other termination where the recording devices are connected solving the problem.

The TSD-DA28 is a 2 x 8 distribution amp that can be applied in multiple situations. One commonly encountered situation involves an installation where the owner wants to use a single audio source that has a single unbalanced, stereo output to deliver content to four separate zones, each of which has a dedicated amplifier. An example of this would be a resort / hotel that wanted to provide BGM to the lobby, pool area, tennis courts, and restaurant. Input 1 can be used as the "left" channel and Input 2 can be used as the "right" channel of the stereo source. Outputs 1-4 would be "left" and Outputs 5-8 would be "right" allowing a simultaneous signal to be sent to each zone where volume level could be controlled via that zone's amplifier.

TSD power amplifiers are also useful in multiple installation scenarios as both the specified product or as a solution to an owner requested addition or change to the design. TSD power amplifiers are available in mono 70.7V, TSD-PA10VG and TSD-PA20VG, and 2-channel 4Ω / 8Ω, TSD-PA122G and TSD-PA252G, versions capable of delivering up to 50W of RMS power. These amplifiers can be used to add sound reinforcement in a conference room working in conjunction with a projector or other audio source. One installation scenario where a TSD power amplifier can be effectively incorporated involves a house of worship whose congregation has outgrown the size of its building and attendees now have to stand in the foyer or courtyard where there are no speakers. The TSD-PA10VG is an ideal solution in this scenario. Source audio can be run to this area and connected to the PA10VG through the balanced line level input. Eight speakers tapped at 1W can then be connected to the amplifier to provide the local sound reinforcement. The speaker level can then be adjusted through the front panel control. Atlas Sound TSD amplifiers are the most effective, convenient solution for complex installation problems.



TSD-DA13

Features

- 1 x 3 Distribution Amplifier
- One (1) Balanced Mic/Line Input with Switchable 24V Phantom Power
- High Gain (50dB), Low Noise Mic Preamp
- Summed Dual RCA Input
- Three (3) Isolated Balanced Mic/Line Outputs
- 12dB/Octave Low Cut Filter @ 125Hz
- Signal/Peak Indicator LEDs
- High Gain Output for Driving Long Balanced Lines
- Removable Phoenix Style I/O Connectors
- Separate Ground Connections
- Energy Efficient
- Power Supply Sold Separately



TSD-DA13

Specifications

Input Impedance	1.2K Ω Balanced, 600 Ω Unbalanced
Output Impedance	300 Ω Balanced, 150 Ω Unbalanced
Frequency Response	20Hz - 20kHz (+/-1dB)
THD	.06% @ 1kHz
Signal to Noise Ratio	90dB
24VDC Power Requirements	60mA
Height	1½" (38.1 mm)
Width	4" (101.6 mm)
Depth	2½" (63.5 mm)
Weight	6 oz. (.170 kg)

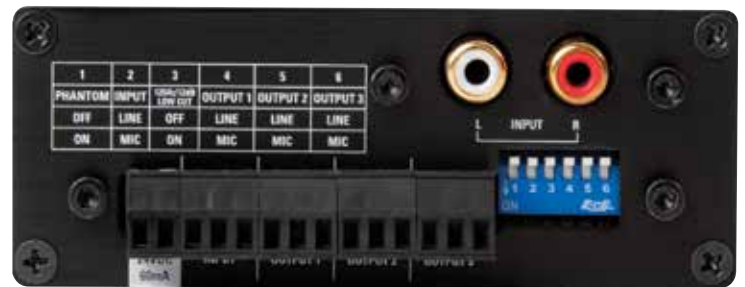

TSD-DA13 Back

TSD-DA28

Features

- 2 x 8 Distribution Amplifier
- Two (2) Balanced Line Inputs
- Eight (8) Isolated Balanced Line Outputs
- Signal & Peak Indicator LED's For Each Channel
- High Gain Output for Driving Long Balanced Lines
- Separate Ground Connections
- Removable Phoenix Style I/O Connectors
- Security Covers Included for All Front Panel Controls
- Energy Efficient
- Power Supply Sold Separately



TSD-DA28

Specifications

Input Impedance	10K Ω Balanced, 5K Ω Unbalanced
Output Impedance	300 Ω Balanced, 150 Ω Unbalanced
Frequency Response	20Hz - 20kHz (+/-1dB)
THD	.06% @ 1kHz
Signal to Noise Ratio	90dB
24VDC Power Requirements	80mA
Height	1½" (38.1mm)
Width	4" (101.6mm)
Depth	2½" (63.5mm)
Weight	6 oz. (.170 kg)

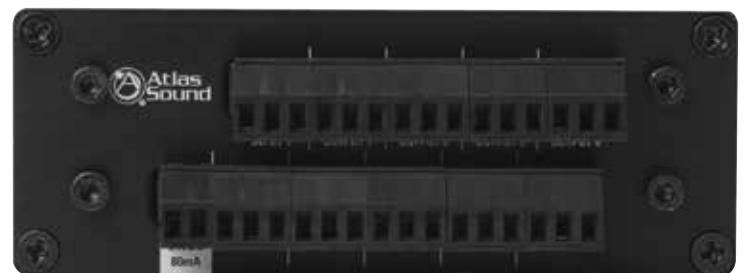

TSD-DA28 Back

TSD-PA10VG

Features

- 4Ω/25V/70.7V/100V Output
- One (1) Balanced Input
- Removable Level Control with Set-It-And-Forget-It Security Cover
- Input Signal and Peak Indicator LEDs
- Cable Management System
- Removable Phoenix Style I/O Connectors
- Energy Efficient
- Compact Chassis Design
- Power Supply Sold Separately
- Optional Rack Mount Kit - TSD-RMK

Specifications

Power Output	10W @ 4Ω 5W @ 8Ω, 10W @ 25V/70V/100V Loads
Line Input Level	500mV (-6dBV) Balanced
Frequency Response	40Hz - 20kHz (+/-3dB)
THD	.5% @ 1kHz
Signal to Noise Ratio	78dBV
24VDC Power Requirements	240mA
Height	1½" (38.1mm)
Width	4" (101.6mm)
Depth	2½" (63.5mm)



TSD-PA10VG

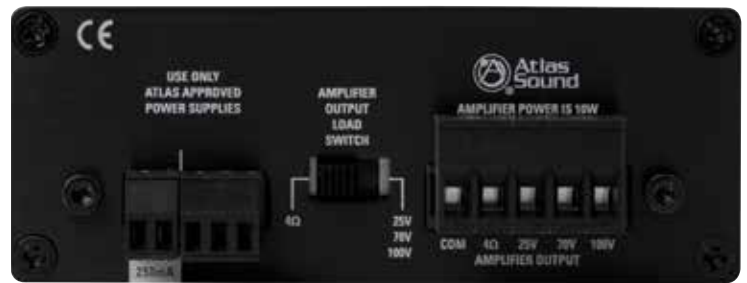

TSD-PA10VG Back

TSD-PA20VG

Features

- 4Ω/25V/70.7V/100V Output
- One (1) Balanced Input
- Removable Level Control with Set-It-And-Forget-It Security Cover
- Input Signal and Peak Indicator LEDs
- Cable Management System
- Removable Phoenix Style I/O Connectors
- Energy Efficient
- Compact Chassis Design
- Power Supply Sold Separately
- Optional Rack Mount Kit - TSD-RMK

Specifications

Power Output	20W @ 4Ω 10W @ 8Ω, 20W @ 25V/70V/100V Loads
Line Input Level	500mV (-6dBV) Balanced
Frequency Response	40Hz - 20kHz (+/-3dB)
THD	15% @ 1kHz
Signal to Noise Ratio	78dBV
24VDC Power Requirements	490mA
Height	1½" (38.1mm)
Width	4" (101.6mm)
Depth	5½" (139.7mm)



TSD-PA20VG



TSD-PA20VG Back

TSD-PA122G

Features

- 12W @ 4Ω x 2 Channels
- Bridgeable to 24W at 8Ω Mono Output
- Balanced Stereo Inputs
- Unbalanced Stereo Inputs Via Dual RCA Connectors
- Input Signal & Peak Indicator LEDs
- Removable Phoenix Style I/O Connectors
- Security Covers Included for All Front Panel Controls
- Energy Efficient
- Power Supply Sold Separately
- Optional Rack Mount Kit - TSD-RMK



TSD-PA122G

Specifications

Power Output	12W @ 4Ω x 2 CH 6W @ 8Ω x 2 CH, 24W @ 8Ω Bridged
Unbalanced Input Impedance	10KΩ
Input Level	316mV (-10dBV)
Balanced Input Impedance	10KΩ Balanced, 5KΩ Unbalanced
Line Input Level	500mV (-6dBV) Balanced
Frequency Response	20Hz - 20kHz (+/-3dB)
THD	1% & 1kHz
Signal to Noise Ratio	80dBV
24VDC Power Requirements	1000mA
Height	1½" (38.1mm)
Width	4" (101.6mm)
Depth	2½" (63.5mm)



TSD-PA122G Back

TSD-PA252G

Features

- 25W @ 4Ω x 2 Channels
- Bridgeable to 50W at 8Ω Mono Output
- Balanced Stereo Inputs
- Unbalanced Stereo Inputs Via Dual RCA Connectors
- Input Signal & Peak Indicator LED's
- Removable Phoenix Style I/O Connectors
- Security Covers Included for All Front Panel Controls
- Energy Efficient
- Power Supply Sold Separately
- Optional Rack Mount Kit - TSD-RMK



TSD-PA252G

Specifications

Power Output	25W x 2 CH @ 4Ω 50W x 1 CH @ 8Ω Bridged
Unbalanced Input Impedance	10kΩ
Input Level	316mV (-10dBV)
Balanced Input Impedance	10KΩ Balanced, 5KΩ Unbalanced
Line Input Level	500mV (-6dBV) Balanced
Frequency Response	20Hz - 20kHz (+/-3dB)
THD	.2% & 1kHz
Signal to Noise Ratio	80dBV
24VDC Power Requirements	2000mA
Height	1½" (38.1mm)
Width	4" (10.16mm)
Depth	5½" (13.2mm)



TSD-PA252G Back



TSD pre-amplifiers and mixers solve many problems often encountered by integrators that save time and money.



Push to Talk Microphone Capability Using the TSD-ML11 in a Courtroom Application



Pre-Amplifiers / Mixers

Applications

TSD pre-amplifier and mixer models were designed to address multiple installation issues often encountered by integrators. Their small chassis size makes them easy to install in a variety of locations. TSD pre-amplifiers and mixers can be used in corporate offices, houses of worship, hospitality, conference rooms, schools, and many other locations.

Features

- Mic/Line Pre-Amps
- Mic/Line Mixers
- Front Panel Input Level Controls
- Front Panel LED Indicators
- Removable Phoenix Style I/O Connections
- Integrated Cable Management System

General Description

Atlas Sound TSD pre-amplifiers and mixers are designed to address a variety of installation and system obstacles that are often encountered by integrators in the field. The TSD-ML11 is a 1x1 mic/line preamp that is perfect for use as a standalone preamp or in conference room systems, board meetings, courtrooms, council chambers, and public forum systems that need mute and push to talk microphone functions. The unit features switchable phantom power for powering condenser microphones and has four EQ cut filters centered at common frequencies to eliminate feedback and control voice shaping. The variable mic preamp helps further eliminate noise for quiet operation as well as reduces unwanted coloration and changes in tonality.

A 12dB/oct @ 125Hz high pass filter is available on each mic input to minimize bass rumble and low frequency feedback in the system and ensure focus and clarity stays on the voice sound spectrum. An output limiter / compressor is also included for system protection to avoid clipping and eliminate distortion. Mic Mute and Mic On control allow microphones in the system to be push-to-talk enabled or muted for speaker priority.

The TSD-ML22VCA is a 2x2 mic/line preamp and VCA provides two high-quality, low noise mic pre-amps, which allow simplification of designs that require remote microphone level adjustment. Switchable phantom power is provided for powering condenser microphones and a 12dB/octave @ 125Hz high pass filter is available on each mic input to minimize bass rumble and low frequency feedback in the system ensuring focus and clarity for the voice spectrum. A common application for the TSD-ML22VCA is often found in restaurants / bars that have both background music and television source audio. In these types of systems one mixer usually controls both sources and can be found in the main equipment rack, which may be difficult to access. The TSD-ML22VCA can be connected to the main mixer but installed in the main bar area with remote controls for both sources. The volume can now be adjusted independently without having to access the equipment rack.

The TSD-RL21 is a two-channel mic/line mixer that can be used as a standalone remote mixer or in conjunction with Atlas Sound power amplifiers in a variety of applications. Channel one may be configured via rear panel dipswitch to accommodate mic or line level while channel two features a stereo summing RCA line level input. Both inputs are adjustable by front panel controls with removable knobs, which may be easily replaced by security covers to prevent tampering. The remote level control feature allows use of the Atlas Sound AAVC-10K (or equivalent) decorative wall plate control for convenient remote adjustment of either the entire mix bus or RCA input 2 only.

The TSD-MIX31RL is a 3x1 mic/line mixer includes two mic / balanced line inputs via removable Phoenix style connectors and a stereo summing dual RCA input. Switchable phantom power is provided for both mic inputs to facilitate condenser microphones. The high quality, low noise internal mic preamps ensure clarity and quiet operation without unwanted coloration. A 12dB / octave high pass filter @ 125Hz also is available on each input to minimize bass rumble and low frequency feedback. Priority paging can be accomplished via contact closure or VOX trigger on Input 1 (mutes input 3 only). Remote level control feature allows use of the AAVC-10K (or equivalent) decorative wall plate control for convenient remote adjustment of either the entire mix bus or input 3 only (typical BGM input). A variable output limiter provides system protection by reducing clipping and distortion.

The TSD-MIX41 is a 4x1 mic/line mixer is ideal for applications where multiple mic or line sources need to be sub mixed or summed. Each input is mic/line switchable with phantom power provided for condenser microphones. The high quality, low noise internal mic preamps ensure clarity and quiet operation without unwanted coloration. A 12dB/octave high pass filter @ 125Hz also is available on each input to minimize bass rumble and low frequency feedback. The TSD-MIX41 can be used to combine 4 mic channels into a single channel in house of worship applications reducing the number of channels required on the mixing board or freeing them up to be used for other inputs.

The TSD-MIX42RT is a 4x2 mic/line mixer with remote control. This unit includes one mic/balanced line input via removable Phoenix style connector and three stereo 3.5mm inputs. Switchable phantom power is provided for the mic input to facilitate condenser microphones. The high quality, low noise internal mic preamps ensure clarity and quiet operation without unwanted coloration. A 12dB/octave high pass filter @ 125Hz also is available on the mic input to minimize bass rumble and low frequency feedback.

Priority paging can be accomplished via contact closure or VOX trigger on Input 1 that will mute Inputs 2, 3, or 4 (assignable). Remote level control feature allows use of the Atlas Sound AAVC-10K or WPD-VC10K decorative wall plate control for convenient remote adjustment of either the entire Master mix bus or Inputs 1, 2, 3. A variable output limiter provides system protection by reducing clipping and distortion.



TSD-ML11

Features

- High Quality Microphone Preamp with Switchable 24V Phantom Power
- Mic/Line I/O via Removable Phoenix Style Connector
- Four (4) Preset Frequency Notch Filters For Tone and Feedback Control
- 125Hz /12dB Low Cut Filter
- Variable Output Limiter / Compressor
- Mic Mute / Mic On Via Contact Closure
- Input Signal & Peak Indicators
- High Gain Output for Long Distance Signal Transmission
- Separate Ground Connections
- Security Covers Included for All Front Panel Controls
- Energy Efficient
- Power Supply Sold Separately



TSD-ML11

Specifications

Input Impedance	1.2K Ω Balanced, 600 Ω Unbalanced
Line Input Level	1V (0dBV) Balanced = 2V (+6dBV) Balanced Output
Mic Input Level	46dB Gain 10mV (-40dBV) Balanced = 2V (+6dBV) Balanced Output
Output Impedance	300 Ω Balanced, 150 Ω Unbalanced
Line Output Level	1V (0dBV) In = 2V (+6dBV)
Mic Output Level	10mV (-40dBV) In = 80mV (-21dBV)
Frequency Response	20Hz - 20kHz (+/-1dB)
THD	.06% & 1kHz
24VDC Power Requirements	100mA
Height	1 1/2" (38.1mm)
Width	4" (101.6mm)
Depth	2 1/2" (63.5mm)
Weight	6 oz. (.170 kg)



TSD-ML11 Back

TSD-ML22VCA

Features

- True VCA For Remote Volume Control of Mic or Line Sources
- Two (2) Mic/Line Inputs
- All I/O Via Phoenix Style Connectors
- High Quality Microphone Preamp with Switchable 24V Phantom Power
- 12dB/Octave Low Cut Filter @ 125Hz
- Input Signal & Peak LEDs
- High Gain Output for Driving Long Balanced Lines
- Separate Ground Connections
- Security Covers Included for All Front Panel Controls
- Energy Efficient
- Power Supply Sold Separately



TSD-ML22VCA

Specifications

Input Impedance	1.2K Ω Balanced, 600 Ω Unbalanced
Line Input Level	1V (0dBV) Balanced = 2V (+6dBV) Balanced Output
Mic Input Level	46dB Gain 10mV (-40dBV) Balanced = 2V (+6dBV) Balanced Output
Output Impedance	300 Ω Balanced, 150 Ω Unbalanced
Line Output Level	1V (0dBV) In = 2V (+6dBV)
Mic Output Level	10mV (-40dBV) In = 80mV (-21dBV)
Frequency Response	20Hz - 20kHz (+/-1dB)
THD	.06% & 1kHz
24VDC Power Requirements	70mA
Height	1 1/2" (38.1mm)
Width	4" (101.6mm)
Depth	2 1/2" (63.5mm)
Weight	6 oz. (.170 kg)



TSD-ML22VCA Back

TSD-RL21

Features

- One (1) Mic/Line Input
- One (1) Summing RCA Line Input
- Remote Level Control Assignable Mix Bus or Input 2 Only
- Balanced Mono Line Out
- Input & Peak Signal Indicator LEDs
- High Gain Output for Driving Long Balanced Lines
- Removable Phoenix Style I/O Connectors
- Security Covers Included for All Front Panel Controls
- Energy Efficient
- Power Supply Sold Separately

Specifications

Input Impedance	1.2K Ω Balanced, 10K Ω Unbalanced
Line Input Level	1V (0dBV) Balanced = 2V (+6dBV) Balanced Output
Mic Input Level	46dB Gain 10mV (-40dBV) Balanced = 2V (+6dBV) Balanced Output
Output Impedance	300 Ω Balanced, 150 Ω Unbalanced
Line Output Level	1V (0dBV) In = 2V (+6dBV)
Frequency Response	20Hz - 20kHz (+/-1dB)
THD	.06% & 1kHz
24VDC Power Requirements	60mA
Height	1½" (38.1mm)
Width	4" (101.6mm)
Depth	2½" (63.5mm)
Weight	6 oz. (.170 kg)



TSD-RL21



TSD-RL21 Back

TSD-MIX41

Features

- Four (4) Balanced Mic/Line Inputs
- Four (4) Professional Grade Microphone Preamps with Switchable 24V Phantom Power
- Up to 50dB Mic Gain Per Input
- 12dB/Octave Low Cut Filter @ 125Hz
- Balanced Line Output
- Input Peak & Signal Indicator LEDs
- Variable Output Limiter
- High Gain Output for Driving Long Balanced Lines
- Separate Ground Connections
- Removable Phoenix Style I/O Connectors
- Security Covers Included for All Front Panel Controls
- Energy Efficient
- Power Supply Sold Separately

Specifications

Input Impedance	1.2K Ω Balanced, 600 Ω Unbalanced
Line Input Level	1V (0dBV) Balanced = 2V (+6dBV) Balanced Output
Mic Input Level	46dB Gain 10mV (-40dBV) Balanced = 2V (+6dBV) Balanced Output
Output Impedance	300 Ω Balanced, 150 Ω Unbalanced
Line Output Level	1V (0dBV) In = 2V (+6dBV)
Frequency Response	20Hz - 20kHz (+/-1dB)
THD	.06% & 1kHz
24VDC Power Requirements	60mA
Height	1½" (38.1mm)
Width	4" (101.6mm)
Depth	2½" (63.5mm)
Weight	6 oz. (.170 kg)



TSD-MIX41

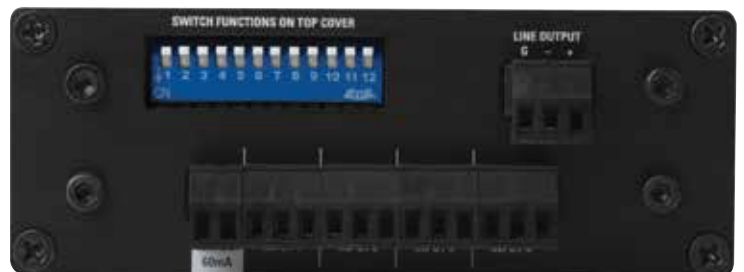

TSD-MIX41 Back

TSD-MIX31RL

Features

- Two (2) Balanced Mic/Line Inputs
- High Gain (50dB) Microphone Preamps
- Switchable 24V Phantom Power
- One (1) Unbalanced Summing Dual RCA Line Input
- Vox Sense and Contact Closure Priority Mute of Ch3
- Variable Output Limiter
- Remote Level Control
- 12dB/Octave Low Cut Filter @ 125Hz
- Input Signal & Peak Indicator LEDs
- High Gain Output for Driving Long Balanced Lines
- Separate Ground Connections

Specifications

Input Impedance	1.2K Ω Balanced, 10K Ω Unbalanced
Line Input Level	1V (0dBV) Balanced = 2V (+6dBV) Balanced Output
Mic Input Level	46dB Gain 10mV (-40dBV) Balanced = 2V (+6dBV) Balanced Output
Output Impedance	300 Ω Balanced, 150 Ω Unbalanced
Line Output Level	1V (0dBV) In = 2V (+6dBV)
Frequency Response	20Hz - 20kHz (+/-1dB)
THD	.06% & 1kHz
24VDC Power Requirements	60mA
Height	1½" (38.1mm)
Width	4" (101.6mm)
Depth	2½" (63.5mm)
Weight	6 oz. (.170 kg)



TSD-MIX31RL



TSD-MIX31RL Back

TSD-MIX32RL

Features

- Three Stereo Unbalanced Line Inputs, One Set of RCA and Two 3.5mm (1/8")
- Balanced Line Outputs Left & Right
- Unbalanced Line Outputs Left & Right
- Output Peak & Signal Indicator LEDs
- Input Signal Indicator LEDs, Qty 3
- Base & Treble Controls \pm 6dB
- Remote Master Level Control
- High Gain Output for Driving Long Balanced Lines

Specifications

Input Impedance	1.2K Ω Balanced, 10K Ω Unbalanced
Line Input Level	1V (0dBV) Balanced = 2V (+6dBV) Balanced Output
Mic Input Level	46dB Gain 10mV (-40dBV) Balanced = 2V (+6dBV) Balanced Output
Output Impedance	300 Ω Balanced, 150 Ω Unbalanced
Line Output Level	300mV (-10dBV) = 1.5V (3dBV)
Frequency Response	20Hz - 20kHz (+/-1dB)
THD	.06% & 1kHz
24VDC Power Requirements	60mA
Height	1½" (38.1mm)
Width	4" (101.6mm)
Depth	2½" (63.5mm)
Weight	6 oz. (.170 kg)



TSD-MIX32RL



TSD-MIX32RL Back

TSD-MIX42RT

Features

- Stereo or Mono Configurations
- One Balanced Mic/Line Input
- Three Unbalanced Stereo Line Inputs 3.5mm
- 12dB/octave High Pass Filter @ 125Hz Available on the Mic Input
- Priority Paging Via Contact Closure or VOX Trigger on Input 1
- Remote Level Control Feature Allows use of the WPD-VC10K Wall Plate Control
- Power Supply Sold Separately

Specifications

Input Impedance	1.2K Ω Balanced, 600 Ω Unbalanced
Line Input Level	1V (0dBV) Balanced = 2V (+6dBV) Balanced Output
Mic Input Level	46dB Gain 10mV (-40dBV) Balanced = 2V (+6dBV) Balanced Output
Output Impedance	300 Ω Balanced, 150 Ω Unbalanced
Line Output Level	1V (0dBV) In = 2V (+6dBV)
Frequency Response	20Hz - 20kHz (\pm 1dB)
THD	.06% @ 1kHz
24VDC Power Requirements	60mA
Height	1½" (38.1mm)
Width	4" (101.6mm)
Depth	5½" (132mm)
Weight	13 oz. (.368 kg)



TSD-MIX42RT



TSD-MIX42RT Back



WPD-MIX42RT

Features

- Stereo or Mono Configurations
- White Decor Style Plate, ABS Material
- Fits a Single Gang Electrical Outlet
- Designed for Remote Activation of Atlas TSD-MIX42RT
- System Status Indicator (Red)
- 8-Conductor Interface Connection
- Level Control Via On Board 10k Ω Potentiometer
- Label Guard (Allows for Clean Custom Function Identification)
- Input Select Slide Switch

Specifications

Connector	Removable 8 Position Phoenix Style Connector, 5.08mm Pin Spacing, Qty. 1
Height	4½" (114mm)
Width	2½" (6.4mm)
Depth	¼" (132mm)
Maximum Tested Distance	200 ft, 22-Gauge Wire



Sequencers and Sound Masking

Applications

Many of today's electronics are very sensitive or have very high current demands. Turning all electronics in a rack at once can lead to component damage that can lead to down time and costly repairs. Using the TSD-SEQ6 electrical sequencer and appropriate sequencing modules allows components to be turned on sequentially reducing the load on the overall system. A properly set-up sound masking system increases worker productivity and maintains speech privacy where required. The TSD-GPN1200 is to install and addresses the sound masking needs of small offices perfectly.

Features

- Front Panel LED Indicators
- Removable Phoenix Style I/O Connections
- Integrated Cable Management System

General Description

The Atlas Sound TSD-SEQ6 Sequencer Controller features 6 outputs that are configurable individually to be either a 24VDC output or Hard Switch Contact Closure (CC). There are two separate output sequence time delay trimmers ranging from 1 second to 10 minutes. Activation can be done via the front panel or remotely via Hard Switch CC, Momentary Switch or DC Voltage. The TSD-SEQ6 also incorporates an Emergency Power Down (EPD) port for local fire codes. This EPD feature is valuable in an installation where a facility owner has a single fire alarm tied to all of their tenant properties, like a shopping center or mall. A contact closure can be connected from the main fire alarm control module to the EPD port on the TSD-SEQ6. When that contact closure is triggered, the unit will turn off any audio or video sources that are plugged into power outlets that are connected to the TSD-SEQ6 enabling the fire alarm to be heard by all. Once the fire alarm emergency is resolved, the power to the components can be restored from the fire alarm using one of the sequence triggers on the unit.

The TSD-GPN1200 sound masking generator is a great solution for basic masking systems. The analog topology design eliminates repeating cycles commonly found in other manufactures low cost digital designs. The TSD-GPN1200 allows selection between pink or white noise sources and incorporates a variable balanced output to match any amplifier input requirements. Additionally, a 4W, output is provided to power up to six masking loudspeakers tapped at .5W each. A variable hi-cut filter with operating range between 1kHz and 8kHz at a slope of 6dB per octave supports equalization requirements for Sound Masking systems. Both outputs may be used simultaneously allowing large zones to be addressed with external equalization and amplification, while a smaller zone can be powered by the internal amplifier, with spectrum control provided by the hi-cut filter.

Hospital or medical center admissions are an ideal place to apply the TSD-GPN1200 when other masking solutions are not installed. Generally patients are processed in a waiting room where other patients are seated. Maintaining patient confidentiality is of paramount importance for the facility to be in line with HIPAA laws. Additionally if there is more than one person behind the desk admitting patients, masking can be applied so that they are not distracted by each other. The TSD-GPN1200 can be used in conjunction with a small 70.7V amplifier that power sound masking speakers in the waiting room ensuring patient privacy during check in while the internal amplifier can power sound masking speakers installed in the staff area.



Sound Masking in Hospitals and Healthcare Facilities Benefit Patient Recovery and Improve Patient Facility Evaluations

TSD-SEQ6

Features

- 6 Sequenced Outputs
- Assignable 24VDC or Hard Switch Contact Closure (CC) per Output
- Sequence 1 is Adjustable: Delay Time 1 Second to 10 Minutes
- Sequences 2 - 6 are Adjustable: Delay Time 1 Second to 1 Minute
- Remote Activation via 5-24VDC, Momentary Contacts, Hard Switch Contacts
- Status Indicator for Each Output
- Emergency Power Down "EPD" Port
- Link Out for Two TSD-SEQ6 Controllers
- Voltage Output for Remote LED Status Display
- Separate Wiring Port for Each I/O
- Cable Management System
- Multiple Mounting Configurations
- Removable Phoenix Style I/O Connectors
- Meets Most Energy Standards
- Compact Chassis Design

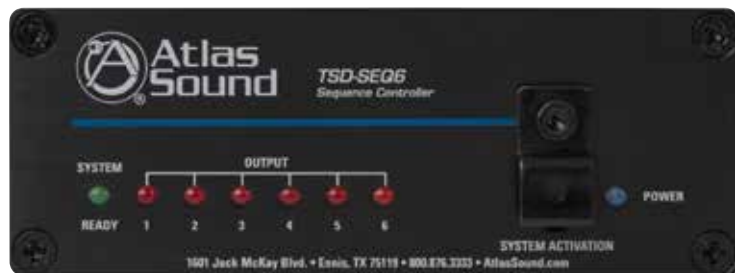

TSD-SEQ6

Specifications

Chassis Construction	Black Aluminum
Sequence Status Indicator	Green, Quantity 1
Output Status Indicator	Red, Quantity 6
Voltage	24VDC, 500mA
Power Consumption Current	100mA
Power Consumption VA Watts	2.4 Watts
Height	1½" (39mm)
Width	4" (101mm)
Depth	2¾" (70mm)
Weight	6oz. (.165kg)

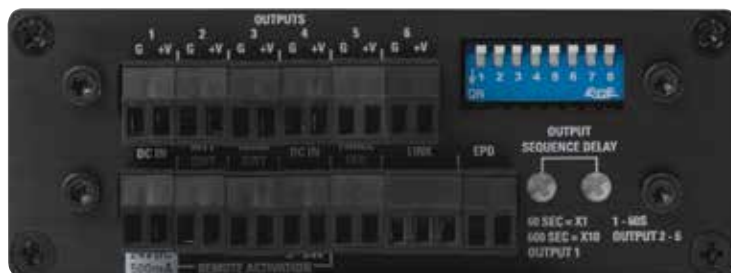

TSD-SEQ6 Back

TSD-GPN1200

Features

- Balanced Line Output Plus 4W, Speaker Output
- Adjustable Gain and Hi-Cut Filter
- EQ & Gain Bypass for Line Output
- Selectable Pink or White Noise Source
- Stand Alone or Rack Mountable
- Security Covers Included for All Rear Panel Controls
- Energy Efficient
- Compact Chassis Design
- Power Supply Sold Separately



TSD-GPN1200

Specifications

Audio Outputs	Line Level and Speaker @ 4W
Frequency Response	20Hz - 20kHz Line Out Pre EQ Only
EQ Filter	High Cut, Variable, 1kHz - 7kHz/6dB
24VDC Power Requirements	250mA
Height	1½" (38.1mm)
Width	4" (101.6mm)
Depth	2½" (63.5mm)
Weight	6 oz. (.170 kg)



TSD-GPN1200 Back



Atlas Sound audio processing TSDs allow integrators the ability to address real world problems with complete solutions rather than having to cobble a solution together or live with the problem.

Audio Processing

Applications

Atlas Sound audio processing TSDs address multiple installation situations that an integrator commonly encounters. Audio level controller, impedance divider / combiner, and high / low level converter solutions can be used in retail, restaurants / bars, event centers, hotels, and other similar environments.

Features

- Removable I/O Connectors

General Description

Audio processing TSD units from Atlas Sound address common problems that installers and integrators often face at job sites. The TSD-ALC2 is an automatic 2-channel audio level controller / limiter that allows designers and installers the ability to set predetermined maximum source levels. The TSD-ALC2 is great for installations with multiple program sources including satellite receivers, mp3 players, etc. that typically have vast output level irregularities. With the TSD-ALC2 inserted in line with these sources, the audience will not be distracted during high volume commercial breaks or when different inputs are selected.

Features include stereo RCA input and output connectors, threshold level, ramp speed selection, and output gain adjustments. The TSD-ALC2 also works well when used in conjunction with Atlas Strategy Series Mixer Amplifiers. For level control and passive combining of stereo sources with Atlas amps, specify (1) AA-YSUM input cable in conjunction with (1) TSD-ALC2 for each source input.

The TSD-ZDC is a universal impedance divider / combiner for passively summing or splitting of mic or line level signals. Features include four unbalanced 10K and four balanced 150Ω inputs / outputs that may be passively split or combined in any arrangement. Typical applications include passive summation of multiple 150Ω mics or stereo 10KΩ sources and passive splitting of 150Ω or 10KΩ input sources to multiple outputs.

Integrators are often faced with a scenario where they need to integrate a stereo, two-channel source with a mono, single channel BGM / paging system. In the past they have had to choose to either use a single channel or short the left and right together, which is very dangerous and can cause the equipment to malfunction. The TSD-ZCD offers a third and more practical solution that allows the integrator to passively “sum” the two channels, without shorting the source outputs together. By feeding the left / right channels into the TSD-ZDC and using the other terminals as the summed output, the source’s outputs “see” a resistive load and are electrically isolated by the TSD-ZCD.

The TSD-TXHL is a high to low level converter designed to interface with 4Ω/25/70/100V distributed speaker lines. An unbalanced line level output is provided to drive remote amplifiers or other devices. The TSD-TXHL allows easy expansion of zones without the need for dedicated wiring to remote locations. The high to low-level converter features an isolated transformer, which will not add measurable load to the speaker line. An output level control allows for trim adjustment to best match the remote amplifier (or other device) input sensitivity.

An ideal application for the TSD-TXHL is a facility that has outgrown its current audio system and facility and needs to add speakers into an expansion. The existing amplifier may be at its speaker capacity and the facility management does not want to incur the expense to pull wire out to the expansion from the existing amplifier room. The existing speaker wire can be connected to the Atlas TSD- TXHL allowing the addition of an amplifier that can feed the speakers in the expansion. The TSD-TXHL is designed to accept 4Ω, 25V, 70V or 100V speaker lines and will convert the signal to line level audio to feed the new amplifier.

The TSD-HF11 is specifically designed use with paging horns in applications where band pass filter and power limiting are required. The TSD-HF11 has a 1 Input and 1 Output configuration and includes Input and Output trim controls, selectable Hi-Pass and Lo-Pass filters, and a variable limiter to prevent excess signal from entering the amplifier. The TSD-HF11 can be used with a variety of paging horns and amplifiers as its full feature set allows individualized customization based on system requirements.



TSD Audio Processing Improve the System Quality in Multi-Source Applications Ensuring All Customers Have a Great Experience

TSD-ALC2

Features

- Stereo Auto Level Control
- Unbalanced RCA Input and Output
- Threshold Level Adjustment
- Ramp Speed Selection
- Output Gain Control
- Security Covers Included for All Front Panel Controls
- Energy Efficient
- Compact Chassis Design
- Power Supply Sold Separately
- Input Level Attenuator (1) Removable Knob w/ Security Cover
- Output Level Limiter (1) Removable Knob w/ Security Cover
- Indicators Input:Green, Input Peak:Red, ALC Active:Yellow, Power:Blue

Specifications

Input Type	(2) Unbalanced, RCA, Left & Right
Input Impedance	10k Ω
Output Type	(2) Unbalanced, RCA, Left & Right
Output Impedance	150 Ω Unbalanced
Output Level	Adjustable from 0V - 1.4V, Hard Limit
24VDC Power Requirements	60mA
Height	1½" (38.1mm)
Width	4" (101.6mm)
Depth	2½" (63.5mm)
Weight	6 oz. (.170 kg)



TSD-ALC2



TSD-ALC2 Back

TSD-ZDC

Features

- Four (4) 150 Ω Stereo Input / Outputs
- Four (4) 10K Stereo Input / Outputs
- Split or Combine Any Signal
- RF Filtering on All Inputs
- Individual Input Grounds
- Removable I/O Connectors
- No External Power Required
- Optional Rack Mount Kit – TDS-RMK

Specifications

150 Ω Network Inputs / Outputs	4, Passive Balanced Networks, Any Channel Can Be Input or Output
10K Ω Network Inputs / Outputs	4, Passive Balanced Networks, Any Channel Can Be Input or Output
Frequency Response	20Hz - 20kHz (+/-1dB)
Height	1½" (38.1mm)
Width	4" (101.6mm)
Depth	2½" (63.5mm)
Weight	6 oz. (.170 kg)

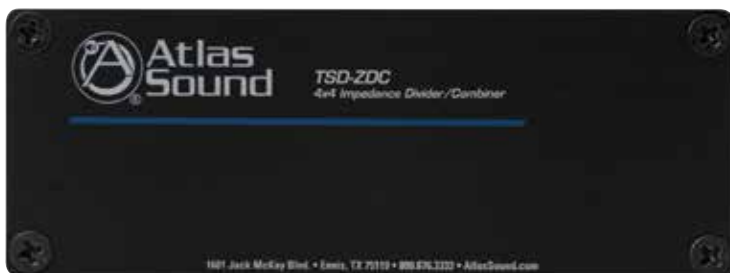

TSD-ZDC

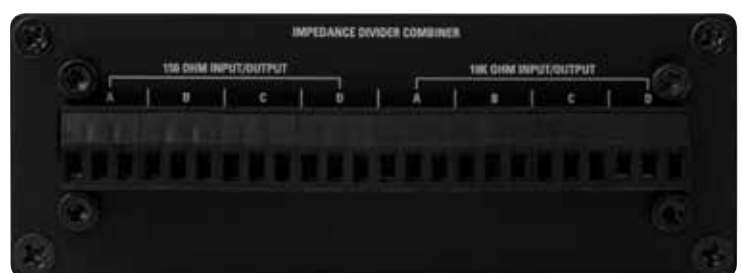

TSD-ZDC Back

TSD-TXHL

Features

- Tap Into 4Ω/25/70/100V Speaker Lines to Interface With Remote Amplifiers
- Input Gain Adjustment Switch
- Trim Level Control
- Isolated Transformer
- Removable I/O Connectors
- No External Power Required
- Optional Rack Mount Kit – TDS-RMK

Specifications

High Level Input	Amplifier Speaker Outputs 4Ω, 8Ω, 25V, 70V and 100V
Output impedance	600Ω Unbalanced
Line Output Level	Max Output 500mV
Frequency Response	40Hz - 25kHz (-3dB)
Height	1½" (38mm)
Width	4" (101.6mm)
Depth	2½" (63.5mm)
Weight	6 oz. (.170 kg)



TSD-TXHL



TSD-TXHL Back

TSD-HF11

Features

- Selectable Hi-Pass and Lo-Pass Filter
- Balance and Unbalance Inputs
- Input and Output Trim Controls
- Variable Limiter
- Security Covers Included for All Front Panel Controls
- Output Signal, Peak & Limit Indicator LEDs
- Removable Phoenix Style I/O Connectors
- Power Supply Sold Separately
- Optional Rack Mount Kit – TDS-RMK

Specifications

Line Input Impedance	10K Ω
Input Level Input	500mv (-6dB) Balanced
Input Level Input	316mv (-10dB) Unbalanced
Frequency Response	20Hz – 15KHz (+/- 1dB)
THD	.2% @ 1KHz
Hi Cut Filter	15KHz 18db / Octave (Fixed)
Low Cut Filter	200Hz, 300Hz, & 400Hz @ 18dB / Octave (Dip Switch Selectable)
24VDC Power Requirements	60mA
Height	1½" (38.1mm)
Width	4" (10.16mm)
Depth	2½" (63.5mm)



TSD-HF11



TSD-HF11 Back



Atlas Sound TSD power distribution and power supplies enable integrators to choose the solution that best fits the needs of their installation. Powering multiple units with a single power supply requires fewer power outlets saving integrators time and money.

General Description

The TSD-DCPD is designed to distribute power to TSD devices or other equipment requiring DC power without the need for separate power supplies. One 9-24V PSU input is distributed to 6 independent, isolated outputs. The compact TSD-DCPD will help remove rack clutter and free up power strip space.

The TSD-DCPDV is designed to distribute power to TSD devices or other equipment requiring DC power and is also ideal for use with wireless microphones that typically require 12-18VDC PSUs. The rear panel includes one 9-24V input for a user selectable power supply up to 2500mA, four fixed 24V outputs and two 5-24V variable outputs. Voltage for variable outputs is adjusted from a secure trim pot. In addition, two front panel USB ports are available for charging other devices or for USB style rack lighting.

The Atlas TSD-PS24V250MA, TSD-PS24V500MA, and TSD-PS24V2500MA are power supplies designed to be used with single Atlas TSD models or with the TSD-DCPD or TSD-DCPDV. Each model has a different output current, 250mA, 500mA, and 2500mA, allowing the integrator to select the power supply that works best for his application based on current requirements and number of TSD units being used.

Power Distribution

Applications

Atlas Sound TSD power distribution units and power supplies are designed to power single or multiple TSD units based on the number of TSDs being used and their combined current requirements.

Features

- Global Input Voltage
- Rack Mountable and Direct Connect Models
- 24VDC Fixed Output Voltage
- Up to 2500mA Output Current

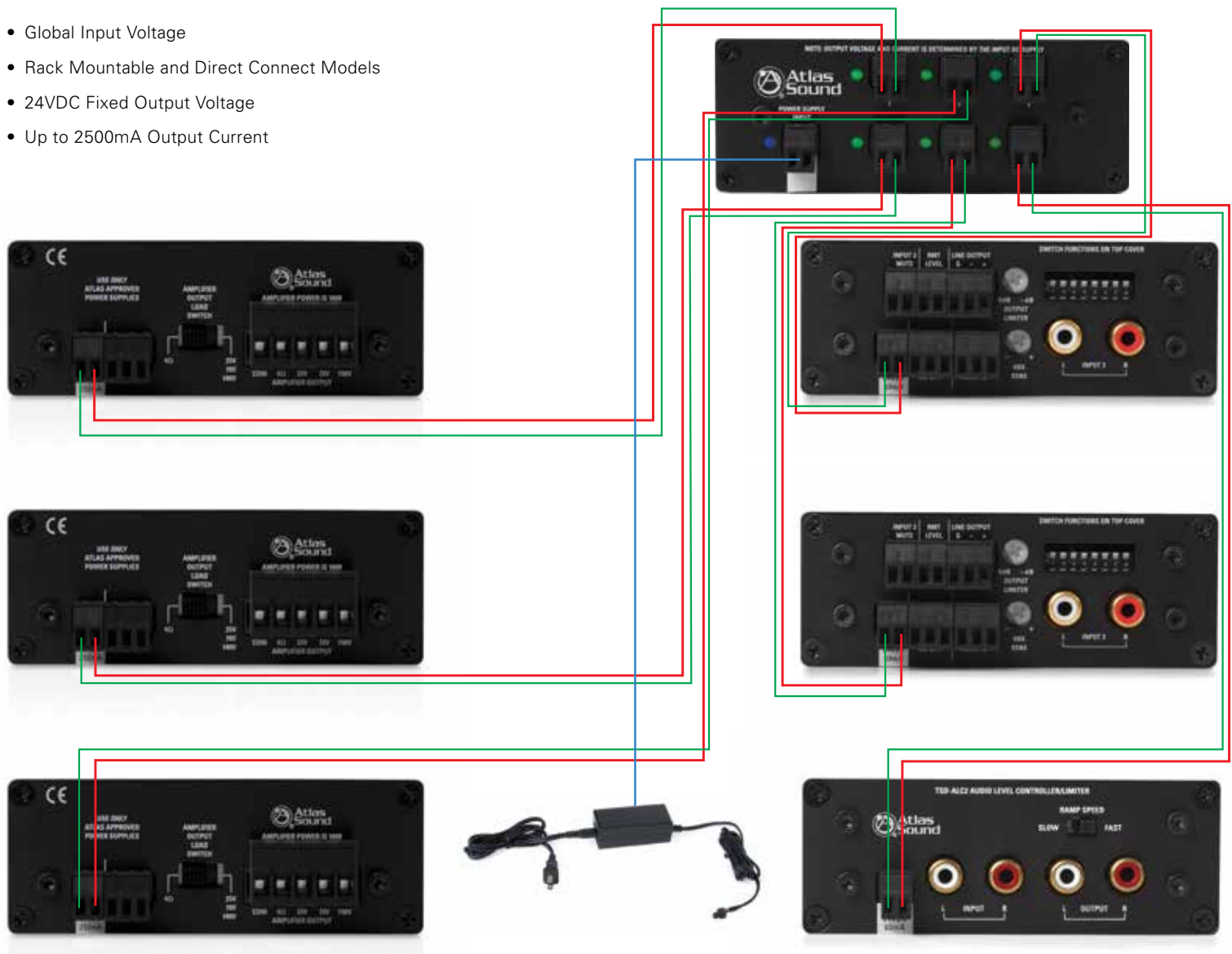

TSD-DCPD

Features

- Power Distribution for Up to 6 TSD's From a Single PSU
- 1 in 6 Out Configuration
- Six (6) Independent 9-24V Outputs
- DC Filtering and Isolation Per Channel
- Energy Efficient
- 9 - 24VDC Input Voltage (Power Supply Current Selection is Dependent on the Number of Devices Connected to the DCPD and Their Accumulative Current Consumption. Use the TSD Power Calculator for Total Current Required)

Specifications

DC Voltage Input	9V - 24V DC, 5A Max
Output Voltage DC	9V - 24V DC, Dependent on the DC Input Voltage
Output Current DC	Power Supply Selection is Dependent on the Number of Devices Connected to the DCPD and Their Accumulative Current Consumption. Use the TSD Power Calculator for Total Current Required.
Height	1½" (38.1mm)
Width	4" (101.6mm)
Depth	2½" (63.5mm)
Weight	6 oz. (.170 kg)

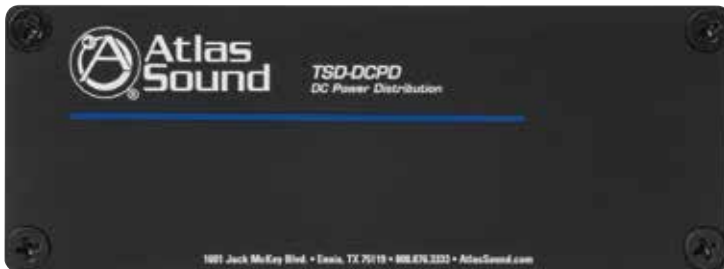

TSD-DCPD



TSD-DCPD Back

TSD-DCPDV

Features

- Power Distribution for Multiple TSD's From a Single Power Supply
- 1 in 6 Out Configuration
- Four (4) Independent 24V Outputs
- Two (2) 5V to 24V Variable Outputs
- Two (2) 5V DC USB charge ports
- DC Filtering and Isolation Per channel
- Separate Ground Connections
- Energy Efficient
- Output Voltage - Variable & Fixed Ports
- Output Current: Power Supply Current Selection is Dependent on the Number of Devices Connected to the DCPDV and Their Accumulative Current Consumption. Use the TSD Power Calculator for Total Current

Specifications

DC Voltage Input	1A-3A, 24V DC, 3A Max
DC Voltage Output Fixed	24V DC, Power Supply Current Selection is Dependent on the Number of Devices Connected to the DCPD and Their Accumulative Current Consumption. Use the TSD Power Calculator for Total Current Required.
DC Voltage Output Fixed USB	5V DC, 500mA Each Power Supply and Load
DC Voltage Variable	Qty 2, Ports 1 Adjustable Voltage, Variable DC Output 5V - 24VDC
Height	1½" (38.1mm)
Width	4" (101.6mm)
Depth	2½" (63.5mm)
Weight	6 oz. (.170 kg)

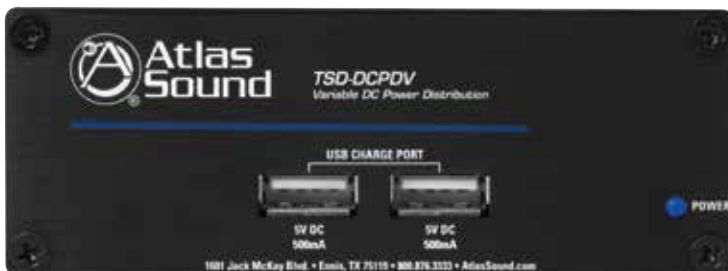

TSD-DCPDV



TSD-DCPDV Back

TSD-PS24V250MA

Features

- Global Input voltage
- Compact design

Specifications

Input Voltage	100VAC - 240VAC
Output Voltage	24VDC
Output Current	
TSD-PS24V250MA	250mA
TSD-PS24V500MA	500mA
TSD-PS24V2500MA	2500MA



TSD-PS24V250MA



TSD-PS24V2500MA



TSD-PS24V500MA

TSD-RMK

Features

- Supports up to 4 TSD Series Modules
- Only Requires 1 Rack Space (1RU)
- Black Brushed Aluminum Finish

Specifications

Height	1¾" (44.45mm)
Width	19" (482.6mm)
Rack Mounts	4 TSD Series Modules



TSD-RMKHR

Features

- Supports up to 2 TSD Series Modules
- Only Requires 1 Rack Space (1RU)
- Black Brushed Aluminum Finish

Specifications

Height	1¾" (44.45mm)
Width	13.79" (350mm)
Rack Mounts	2 TSD Series Modules

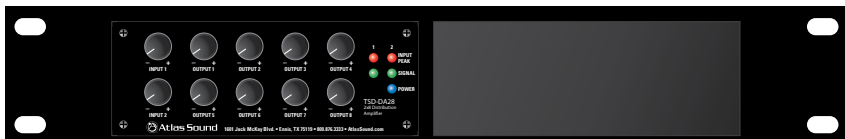



Amplifiers / Generators

Applications

Sound masking / speech privacy solutions can be used in many different situations. Distracting noises in office applications are an excellent example of where sound masking can be deployed. Worker conversations and general office noise can decrease worker productivity and lead to poor customer service, increased errors, and decreased employee satisfaction. Sound masking can also be applied as a means to protect privacy. Executive offices, human resource departments, banking institutions, schools, and healthcare facilities often deal with private information that needs to be kept confidential. A properly installed and configured sound masking system can address all of these situations to maximize efficiency and privacy.

Features

- White and Pink Noise Generators
- Phoenix Style Connectors
- Front Panel LED Indicators
- Rack Mountable
- Network Controlled Models Available

General Description

Atlas Sound offers several sound masking generators. The DSP8807 is a self-contained, compact multi-zone digital controlled sound masking processor. The Atlas Sound DSP8807 unit is capable of automatic mixing, set up and administration of all 8x8 inputs / outputs per zone (channel) via an intuitive 'simple to use' Graphic User Interface (GUI) managed via a local Windows® based laptop or desktop computer. The DSP8807 has 8 channels of independent on-board digital class-D amplifiers that are capable of delivering 50W RMS at 70.7V output. Additionally a simultaneous audio line level output rated at 1V/600Ω (nominal) per zone is available for driving higher power amplifiers. The DSP8807 also has two independent uncorrelated pink noise generators, which are random and non-repeating up to 215 hours with EQ adjustments programmable on a per zone basis.

The DSP2212 and DSP2210 incorporate many of the same features found in the DSP8807 on a smaller scale. Each unit features 2 channels of independent on-board digital class-D amplifiers that are capable of delivering 25W RMS at 70.7V output. Both units also feature a pink noise generator that is random and non-repeating up to (215) hours with EQ adjustments programmable on a per zone basis. The DSP2212 is also network controllable utilizing the same GUI found in the DSP8807 for network zone paging control.

The Atlas ASP-MG24 and ASP-MG24TDB are 2 input with 4 masking generators x 4 output DSP configurable by a very intuitive set-up GUI. Each input is tied to an independent white / pink noise generator with adjustable ramp-up to allow gradual acclimation to masking levels. Two additional inputs are available for mic or line sources to allow paging and / or music sources to be blended with the masking sources to any of the 4 outputs. Dedicated 1/2 octave filter sets are available for each of the 4 generator outputs, 8 band parametric EQ blocks along with dynamic control is available for each of the two mic / line inputs. Any mix of all 6 inputs may be easily matrixed to the 4 output DSP blocks for additional parametric equalization, delay, and limiting (if required). The ASP-MG24TDB also includes a scheduler card that allows for timing and level control of all masking inputs for daytime, holiday, and weekend scheduling.

The TSD-GPN1200 is a 1/4 rack unit generator that allows for selection of pink or white noise sources and incorporates a variable balanced output to match any amplifier input requirements. The unit also features a 4W output to power up to six masking loudspeakers tapped at 0.5W each. The AM1200 is a self-enclosed masking system that utilizes two internal 2"x4" speakers powered by a 12W amplifier. The unit includes white and pink noise analog sources as well as a variable high cut filter that allows environmental adjustability.

Atlas Sound offers the most comprehensive selection of Sound Masking/Speech Privacy solutions in the industry. Sound masking amplifiers/generators are the source for any system and Atlas offers several varieties to meet the needs of any installation.



Open Office Designs Are Ideal Applications for Sound Masking Solutions

DSP8807

Features

- 8 Channels of Random Pink Noise Generator Non-Repeating Up to 215 Hours
- 8 Audio Outputs of 50 Watts RMS Digital Class-D Amplification at 85% Efficiency
- 8 Audio Line Outputs at 1V/600Ω (Nominal) for Unlimited Power Per Zone
- IEEE802.1 AVB (Audio Video Bridging) Technology for Time Aligned Networking of Multiple Units
- AVB Operation Allows IP Based Paging Via Ethernet Connection
- Telco Paging Input (Loop Start) With 2 to 5 Digit DTMF (Touch Tone) Dial Plan Defined In GUI
- 8 Ambient Sensing Microphone Inputs (RJ45) for Automatic Level Sensing (6dB) and Control
- Multiple Audio Source Inputs for Background Music, Paging and Emergency Page Overrides
- Zone Expansion From 1 to 2,048 Via Standard CAT5e – CAT6 Cabling (Up To 253 Systems)
- UL / CUL / FCC and CB (International) Listed
- Emergency Override Inputs for Automatic Page Override

Specifications

Output	50W @70.7V x 8
Frequency Response	80Hz – 20kHz ± 3dB at Rated Output
Connector Type	Phoenix
Rack Spaces	2
Power Requirements	110-120VAC 60Hz 450W
Height	3.5" (88.9mm)
Width	19" (482.6mm)
Depth	14" (358mm)
Weight	32.77 lbs (14.86 kgs)



DSP8807

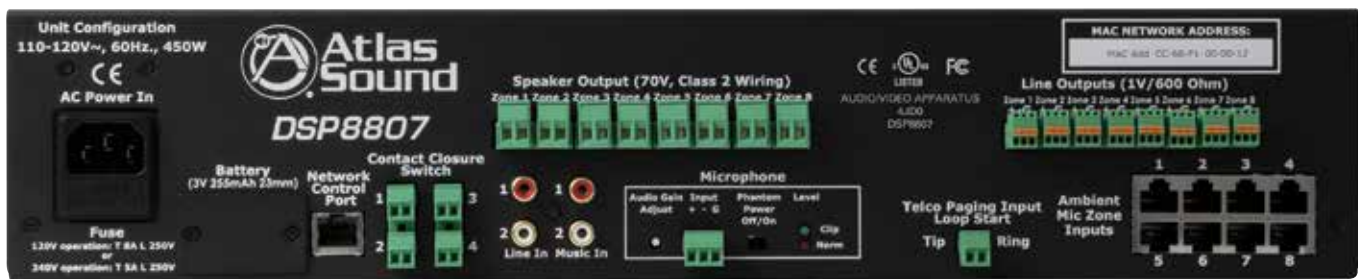

DSP8807 Back

DSP2212

Features

- Two (2) Channels of Random Pink Noise Generator Non-Repeating Up to 215 Hours
- Two (2) Audio Outputs of 25 Watts RMS Digital Class-D Amplification at 85% Efficiency
- IEEE802.1 AVB (Audio Video Bridging) Technology For Time Aligned Networking of Multiple Units
- Multiple Audio Source Inputs for Background Music and Paging
- On-board MAC Address for IP Addressability Compatible with DHCP Server
- Zone Expansion From 2 to 64 Via Standard Ethernet LAN
- All-Call Page, Group Zone Page and Single Zone Page Defined in GUI
- Visual Status Front LCD Display for All Major Input and Output Control Functions
- UL / CUL / FCC and CB (International) Listed

Specifications

Output	25W @70.7V x 2
Frequency Response	80Hz–20kHz (±3dB) at Rated Output
Connector Type	Phoenix - Summary RCA
Rack Spaces	1
Power Requirements	80-240VAC, 50-60HZ
Height	1¾" (44.5mm)
Width	19" (482.6mm)
Depth	10" (254mm)
Weight	11.95 lbs (14.86 kgs)



DSP2212



DSP2212 Back

DSP2210

Features

- Two (2) Channels of Random Pink Noise Generator Non-Repeating Up to 215 Hours
- Two (2) Audio Outputs of 25 Watts RMS Digital Class-D Amplification at 85% Efficiency
- Multiple Audio Source Inputs for Background Music and Paging
- Visual Status Front LCD Display for All Major Input and Output Control Functions
- UL / CUL / FCC and CB (International) Listed

Specifications

Output	25W @70.7V x 2
Frequency Response	80Hz–20kHz (±3dB) at Rated Output
Connector Type	Phoenix - Summary RCA
Rack Spaces	1
Power Requirements	80-240VAC, 50-60HZ
Height	1¾" (44.5mm)
Width	19" (482.6mm)
Depth	10" (254mm)
Weight	11.95 lbs (14.86 kgs)



DSP2210



DSP2210 Back

ASP-MG24

Features

- Easy Downloads From The Atlas Sound MEQ Masking Program Make System Tuning A Breeze.
- The ASP-MG24 DSP Architecture Is Equally Suited For Complex Masking Systems And For Control Of Atlas Sound Full Range Speakers And / Or Subwoofers.
- The Intuitive ASP-MG24 Set-Up GUI Is Designed To Simplify Even Complex Setups That Utilize Multiple Sources Plus Masking In The Same Zone.

Specifications

Output Power	+22dBm Balanced, +18dBm Unbalanced
Frequency Response	20Hz - 20KHz +/- 0.1dB
Connector Type	Phoenix
Rack Spaces	1
Power Requirements	110-120VAC 60Hz 20W
Height	1 3/4" (44.45mm)
Width	19" (482.6mm)
Depth	8" (203.2mm)
Weight	10 lbs (4.54 kgs)



APS-MG24



APS-MG24 Back

ASP-MG24TDB

Features

- Easy Downloads From The Atlas Sound MEQ Masking Program Make System Tuning A Breeze.
- The ASP-MG24 DSP Architecture Is Equally Suited For Complex Masking Systems And For Control Of Atlas Sound Full Range Speakers And / Or Subwoofers.
- The ASP-MG24TDB Provides Accurate Detailed Control Over Masking Levels For All 4 Masking Generators Based On An Easy To Use Scheduler.
- The Intuitive ASP-MG24 Set-Up GUI Is Designed To Simplify Even Complex Setups That Utilize Multiple Sources Plus Masking In The Same Zone.

Specifications

Output	+22dBm Balanced, +18dBm Unbalanced
Frequency Response	20Hz - 20KHz +/- 0.1dB
Connector Type	Phoenix
Rack Spaces	1
Power Requirements	110-120VAC 60Hz 20W
Height	1 3/4" (44.45mm)
Width	19" (482.6mm)
Depth	8" (203.2mm)
Weight	10 lbs (4.54 kgs)



APS-MG24TDB



APS-MG24TDB Back

TSD-GPN1200

Features

- Balanced Line Output Plus 4W, Speaker Output
- Adjustable Gain and Hi-Cut Filter
- EQ & Gain Bypass for Line Output
- Selectable Pink or White Noise Source
- Stand Alone or Rack Mountable
- Security Covers Included for All Rear Panel Controls
- Energy Efficient
- Compact Chassis Design
- Power Supply Sold Separately

Also Available as a Kit - GPN1200K

Includes TSD-1200 , TSD-PS24V250MA, TSD-RMK



TSD-GPN1200



TSD-GPN1200 Back

AM1200

Features

- Self-Contained Audio Masking System
- Includes Two Efficient Wide Range 2" x 4" Speakers
- Internal 12W x 2 Channel Class D Amplifier
- Selectable White and Pink Noise Analog Generators
- External UL Rated 24VDC Power Supply
- UL60065 Listed

Specifications

Output	12W x 2 @ 70.7V (416Ω)
Frequency Response	200Hz – 4kHz
Connector Type	Terminal Block
Power Requirements	24VDC
Height	2.68" (68mm)
Depth	6" (152mm)
Width	7.25" (184mm)
Weight	4 lbs. (1.81 kg)



EQM131

Features

- High Performance ISO Centered Constant Q Filters
- Low Noise Floor, Wide Dynamic Range And All Metal Construction Makes The EQM131 A Perfect Choice For Any Application Requiring Equalization
- XLR, TRS and RCA Inputs & Outputs

Specifications

Output	+22dBu Balanced, +18dBu Unbalanced
Frequency Response	20Hz - 20KHz +/-0.5dB
Connector Type	XLR/TRS and RCA
Rack Spaces	1
Power Requirements	115/230VAC 50/60Hz
Height	1 3/4" (44.45mm)
Width	19" (482.854mm)
Depth	8 1/2" (215.9mm)
Weight	7.25 lbs (3.29 kgs)



EQM131



EQM131 Back



Sound Masking Can Help Protect Individual Privacy in Public Places like Waiting Rooms



Sound masking speakers are available in several styles to meet the needs of any installation. Sound masking is a much more effective solution for achieving speech privacy and sound masking speakers from Atlas Sound are an easy way to reduce distractions and increase privacy in any environment where productivity and confidentiality are important.

General Description

The most common place where sound masking principles are applied is in large, open office spaces especially where cubicles are present. These types of offices often have drop tile or open ceiling designs and the Atlas M1000-USA, M1000, M1000-W, and M1000R-W are ideally suited to function in these applications. Each of these models includes a high efficiency 8" driver in a sealed enclosure that extends low frequency response. Each model features an external power tap adjustment that allows easy adjustment even when the speaker is installed. The M1000-USA / M1000 / M1000-W includes a snap hangar assembly that allows for quick installation above suspended ceiling systems. Each model is safety listed to both UL1480 and UL2043 certifications. M1000-USA is manufactured by Atlas Sound in Ennis, TX and meets Buy America Act requirements.

The M812-S2T7-BX-RS is an 8" dual lone sound-masking speaker that is specifically designed for the acoustical requirements of a suspended tile ceiling application. This unit is shipped fully assembled and wired for quick and easy installation. The power tap adjustment is conveniently located on the outside of the enclosure where it is easy to adjust once installed. The M812-S2T7-BX-RS is safety listed to UL1480 certification.

The M2000-LP is a low profile sound masking speaker designed to be used in locations where a larger speaker will not work including under floorboards, on top of cabinetry, or on other architectural fixtures. This unit includes dual 2" x 4" high efficiency, paper cone loudspeakers. The included 70.7V transformer offers power taps up to 4W and the unit is safety listed to UL1480 and UL2043 certification.

The M2000-SM is a security sound masking solution that includes a two-part transducer and transformer. The transducer can be used on any flat surface including windows, doors, walls, and air ducts. The transducer uses NXT™ Exciter Technology to disrupt eavesdropping devices in offices, conference rooms, or other rooms where security and privacy are a concern. The M2000-SM works with any Atlas sound masking generator and 70.7V amplifier.

Sound Masking Speakers

Applications

Sound masking / speech privacy is often misunderstood. Many users misunderstand that sound masking actually raises the ambient noise level in the area rather than eliminating sound with a magical "cone of silence". Atlas sound masking speakers are designed to address speech privacy in many different installation scenarios including suspended and open ceiling spaces.

Features

- Internal 70.7V Transformer
- All Speaker-Only Models Certified to UL1480 Standard
- Black and White Models Available



Sound Masking Speakers Are Invisible Solutions that Protect Speech Privacy in a Variety of Applications

M1000-USA

Features

- Pre-Assembled Unit Includes 8" Dia. Loudspeaker, Transformer, Enclosure, Baffle And Mounting Hardware
- Labor-Saving Hardware Package - Complete With New Snap Hanger Assembly, Allows Quick And Easy Installation
- Innovative Input Panel Includes Combination Knock-Out And Strain Relief Connector To Accommodate Flexible Or Rigid Conduit
- Suitable For Use Above Suspended Ceiling Systems Or Open Ceiling Spaces Approved For Use In Air Handling (Plenum Ceilings)
- Masterpack Quantity Ordering Requirements Eliminate Jobsite Waste Materials (Quantities of 4 Only)
- UL1480 & UL2043

Specifications

Loudspeaker	8" Dual Cone
Power Taps	.25, .5, 1, 2, & 4 Watts
Frequency Response	100Hz - 10kHz, \pm 1.5dB
Enclosure Volume	734 in ³
Dispersion	Upward, Downward, or Horizontal
Sensitivity	97dB Peak, 94dB Average
Height	5.5" (139.7mm)
Width	11.56" (294mm)
Depth	11.56" (294mm)
Weight	9.37 lbs (4.25 kgs)
Safety Listing	UL 1480 & UL 2043



M1000 / M1000-W

Features

- 734 Cubic Inch Enclosure For Extended Low Frequency Response
- Black Epoxy Finish Blends With Open Ceiling Plans
- Design Enables Upward, Downward And Side Firing Sound Dispersion
- Innovative Input Panel Includes Combination Knock-Out And Strain Relief Connector To Accommodate Flexible Or Rigid Conduit
- Labor-Saving Hardware Package - Complete With New Snap Hanger Assembly, Allows Quick And Easy Installation
- Plenum Rated
- Pre-Assembled Unit Includes 8" Dia. Loudspeaker, Transformer, Enclosure, Baffle And Mounting Hardware
- Suitable For Use Above Suspended Ceiling Systems
- UL1480 and UL2043 Listed
- Also Available in White

Specifications

Loudspeaker	8" Dual Cone
Power Taps	.25, .5, 1, 2, & 4 Watts
Frequency Response	100Hz - 10kHz, \pm 1.5dB
Enclosure Volume	734 in ³
Dispersion	Upward, Downward, or Horizontal
Sensitivity	97dB Peak, 94dB Average
Height	5.5" (139.7mm)
Width	11.56" (294mm)
Depth	11.56" (294mm)
Weight	10 lbs (4.54 kgs)
Safety Listing	UL 1480 & UL 2043



M1000

M1000-W

M1000R-W

Features

- Sleek, Round Appearance Designed For Mounting In Open Plenum Areas Where Speakers May Be Visible
- Balanced Enclosure Design To Ensure Level Orientation When Suspended (78" (2M) Suspension Chain Included)
- Fully Assembled Package Includes 8" Transducer With High Quality Line Matching Transformer
- 0.25 to 4 Watt (@70.7V) Power Selection (Plus OFF) Via External Switch
- 382 in³ (6.26L) Enclosure Volume For Accurate Low Frequency Masking Spectrum Reproduction
- Strain Relief To Facilitate Input Termination
- Tested and approved to UL2043 Standard For Use In Air Handling (Plenum) Spaces
- White Finish To Blend In With Almost Any Ceiling Décor
- UL1480 and UL2043 Listed

Specifications

Loudspeaker	8" Dual Cone
Power Taps	.25, .5, 1, 2, & 4 Watts
Frequency Response	100Hz - 10kHz ±1.5dB
Enclosure Volume	382 in ³
Dispersion	Upward
Sensitivity	97dB Peak, 94dB Average
Height	3.937" (100mm)
Outside Diameter	12.992" (330mm)
Weight	9.75 lbs (4.42 kgs)
Safety Listing	UL 1480 & UL 2043



M812-S2T7-BX-RS

Features

- Completely Assembled and Wired for Easy Installation
- Finished in Black Epoxy
- Specifically Designed for Installation in Suspended Tile Ceiling Systems

Specifications

Loudspeaker	8" Dual Cone
Power Taps	.5, 1, 2, 5 Watts
Frequency Response	100 Hz - 10 kHz, ± 1.5dB
Enclosure Volume	529 in ³
Dispersion	Upward
Sensitivity	97dB Peak, 94dB Average
Height	4" (10.16 cm)
Width	11 5/8" (29.5275 cm)
Depth	11 5/8" (29.5275 cm)
Weight	9 lbs (4.08 kgs)
Safety Listing	UL 1480



M2000-LP

Features

- Pre-assembled Unit Includes Two 2" x 4" Paper Cone Speakers
- Built in 70.7V Transformer with Taps available from .25 - 4 Watts Adjustable Via A Front Mounted Switch Includes an Off Setting
- Romex™ Clamp Input with Two 18-gauge Leads Color Coded in Red & Black)
- UL1480 & UL2043

Specifications

Loudspeaker	Two 2" x 4" Paper Cone Speakers
Power Taps	.25, .5, 1, 2, & 4 Watts plus an Off Setting
Frequency Response	100 Hz - 10 kHz, ± 1.5dB
Enclosure Volume	137.8in ³
Dispersion	Omni
Sensitivity	97dB Peak, 94dB Average
Height	2 5/8" (67mm)
Width	7 1/2" (191mm)
Depth	7" (178mm)
Weight	4 lbs (1.81 kgs)
Safety Listing	UL1480 & UL2043



M2000-SM

Features

- Two Part Assembly
- Works with Many Flat Surfaces
- Transformer Taps ¼ - 4 Watts
- Security Masking Setup for Privacy

Specifications

Transformer	
Height	2" (60.3 mm)
Length / Width	3 1/2" (88.9 mm) Square
Transformer Taps	.25, .5, 1, 2, & 4 Watts

Transducer	
Height	1" (25.4 mm)
Length / Width	2 1/2" (63.5 mm) Square
Cable Length	117" (3 m)
Weight	1.55 lbs (.703 kgs)





IP Based Paging, Intercom, and Emergency Messaging Over Your Existing Network and Phone System.

ControlKom 2.0

Applications

ControlKom 2.0 offers a comprehensive VoIP-based paging system control with SIP (Session Initiation Protocol) compatibility allowing for integration with almost any existing phone system. The integrated features and controllability of ControlKom 2.0 make it ideal for deployment in education institutions, healthcare facilities, or anywhere that an IP paging network is required.

* Disclaimer: ControlKom 2.0 is only offered through authorized dealers.

Features

- Integrates with Any VoIP via SIP or Analog PBX Via Adaptor
- Easy to Use PC Based GUI
- Scalable Control, LAN and WAN Capability
- Send Live or Prerecorded Messages Over Network
- Remote Message Activation
- Integrated Bell Scheduler
- Integrated Alert Groups Including Weather and Amber Alert
- Works with Variety of Atlas Sound IP Speakers and Zone Controllers
- Full Duplex Intercom with Applicable Microphone Enabled Devices
- Unicast over WAN, Multicast over LAN
- Emergency Call Buttons
- Message Priority
- Available Only Through Authorized Dealers

General Description

ControlKom 2.0 allows for live, prerecorded, or ad hoc messages along with control data to be sent over existing or new multicast enabled local area networks to Atlas Sound IP speaker and zone controller end points powered by AF compliant POE switches (or local DC power). ControlKom 2.0 incorporates solutions for the task of managing campus-wide messaging, bell scheduling, security, synchronizing clocks, intercom / paging, and much more.

This software/hardware combination provides a true “one wire” network audio solution reducing the initial cost and eliminating long-term maintenance of separate paging/intercom systems. ControlKom 2.0 employs standard TCP/IP network protocols and DHCP for speaker IP address assignment. ControlKom 2.0 offers a comprehensive IP-based paging system control with SIP (Session Initiation Protocol) compatibility allowing for integration with almost any existing phone system. With this technology, users can simultaneously send an audio stream and/or text message to IP loudspeakers, computer screens, and overhead paging systems, all with speed, confidence, ease-of-use, and reduced operating costs. Configuration of the server based ControlKom software is accomplished via an intuitive web interface. This interface allows the administrator to easily define user privileges, loudspeaker zones, pre recorded messages and other system. ControlKom then provides the user with voice prompt instructions for message type (live or ad hoc) and desired broadcast zone destination.

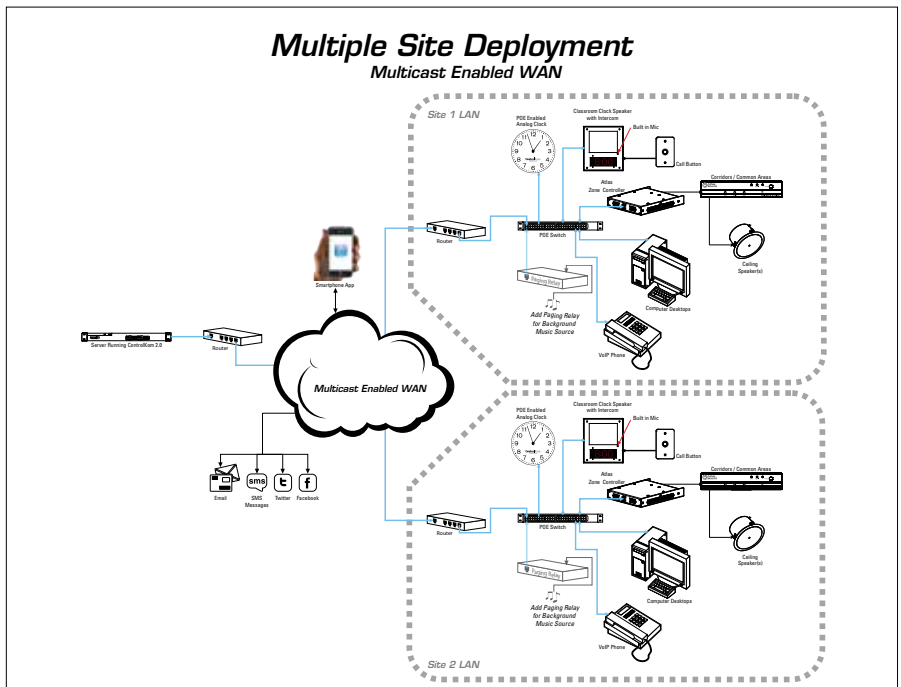

ControlKom is extremely versatile and can be deployed in single site applications or in multisite applications using both Unicast and Multicast enabled WANs

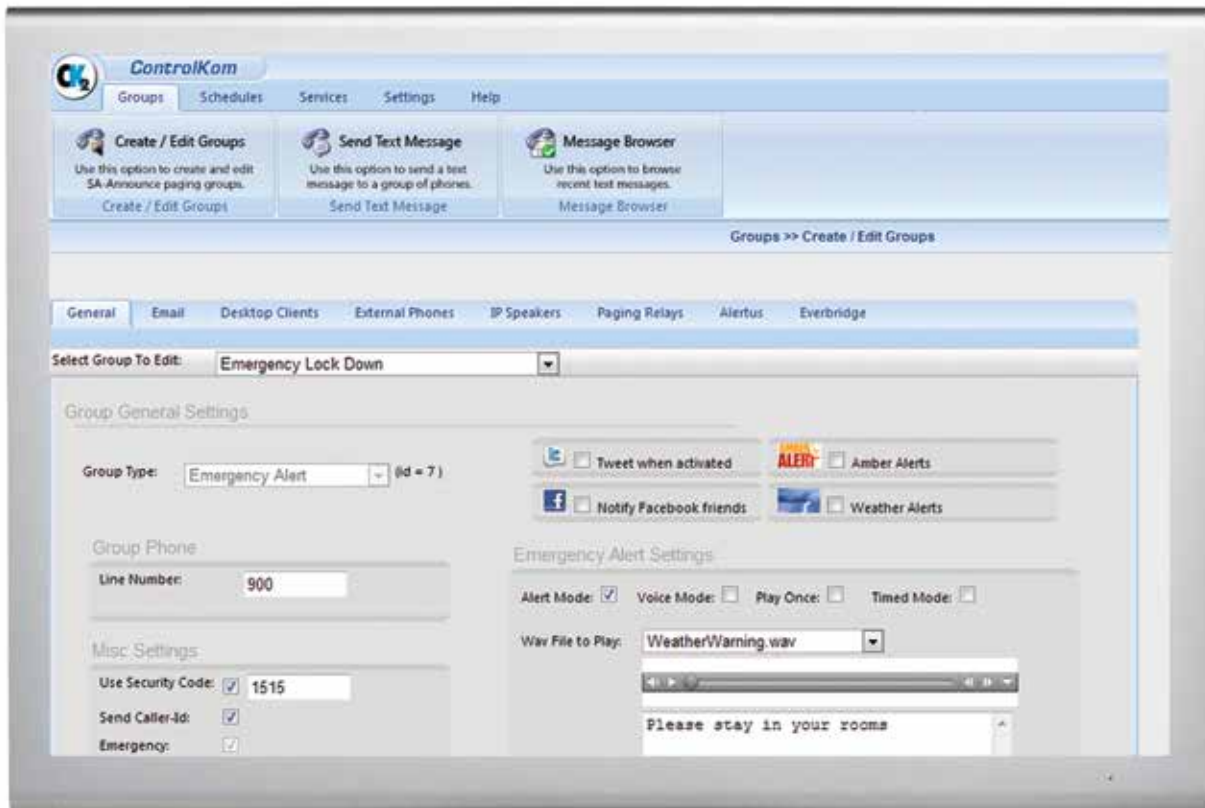

Emergency Group Message Creation Screen - Send Emergency Audio and/or Text Message to Selected Group

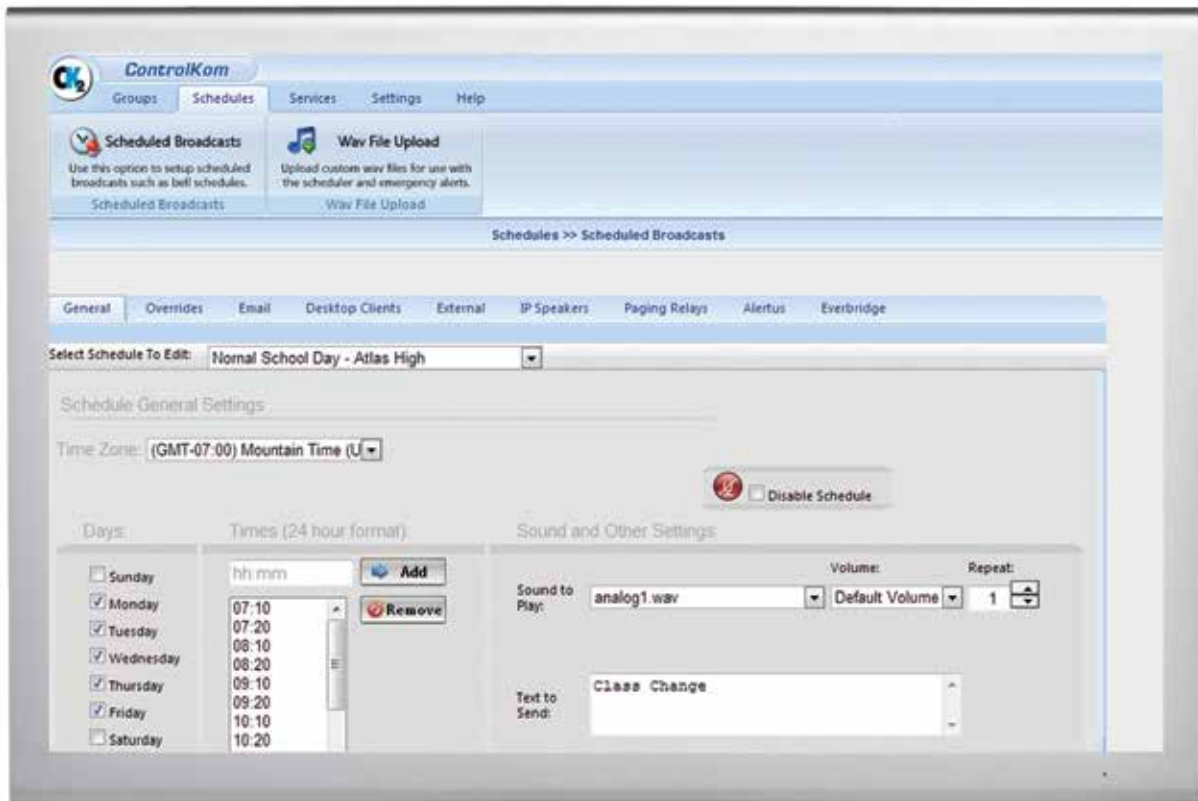

Scheduled Broadcast Screen - Create and Adjust Schedule for All Broadcasts Including Bells and Other Recurring Notifications



For over 10 years Atlas Sound has offered a wide range of IP based speakers that incorporate high fidelity sound, ease of use, and worry free operation making them the ideal choice for any IP based speaker deployment.

IP Speakers - ControlKom/Syn-Apps SA-Announce

Applications

IP Speakers provide a better solution than “phone only” paging by increasing intelligibility in high noise areas and using targeted dispersion to aim sound where it truly needs to be heard. In complex zone paging scenarios IP speakers are often more economical than traditional paging speakers. IP speakers are ideal solutions for installations including education and healthcare facilities.

Features

- Safety Listed to UL60950-1
- In-Wall, In-Ceiling, and Vandal Resistant Models Available
- Models Available with Built-In Microphones for Duplex Paging Applications
- Digital Clock Versions Available with 5 Character LED Display
- Compression Horn Models Available for Higher Volume Areas
- Straight, Angled, and Flush Mount Enclosures Available
- CK Models Support ControlKom 2.0 and Non – CK Support Other Software Packages

General Description

Atlas Sound model I8S-CK includes a factory assembled loudspeaker / baffle with PCB amp/control board securely mounted to the rear of the baffle via concealed weld studs. The amp/control board is capable of producing 9 Watts RMS into the 8Ω loudspeaker with 48VDC minimum power provided by IEEE 802.3AF compliant POE switches. (local 12-18VDC PSUs may also be used instead of POE switches). Interconnection is via a board mounted female RJ-45 connector. This model include the industry standard C10A loudspeaker, which is a dual cone 8" (205mm) loudspeaker with a 10oz (260g) ceramic magnet. It includes a curve-linear paper cone for lower harmonic distortion. The loudspeaker is also equipped with a full 1" (25mm) diameter copper voice coil with aluminum former for better heat dissipation. The 18 gauge construction of the metal baffle provides security and durability in commercial applications. The baffle is finished in neutral white electrostatic powder coat and is packaged with all necessary mounting screws.

The I8SC-CK utilizes the same speaker and control board used in the I8S-CK but incorporates a red, 5-element LED display. This display is capable of creating numbers that are 2.75" high and 1.25" wide. This model is especially useful in school common areas like cafeterias, libraries, and multipurpose rooms. Most software applications used in conjunction with these speakers will maintain accurate time to all speakers with this feature on the network, eliminating the need for separate clocks and time required to adjust analog clocks. The I8SM-CK is identical to the I8S-CK but includes an integrated microphone. This microphone allows for two-way, full duplex intercom communication. This speaker is ideal for use in a classroom where the administration and teacher may have the need to communicate directly with each other outside of a normal paging event. A unit with an integrated microphone is also available with the LED display. This model, I8SCM-CK, is the ultimate solution for classrooms, combining the duplex paging capability with the built in clock.

The I8SCH-CK includes a 7" compression driver horn rather than the 8" dual cone loudspeaker found in other models. This compression driver horn is capable of delivering higher volume levels making it an excellent solution for larger areas including lobbies, cafeterias, libraries, and multi-purpose rooms. This model also includes the 5-element LED display found in the I8SC-CK. The baffle for this model includes 18 gauge construction along with a perforated 22 gauge metal screen that is provided over the loudspeaker to maximize performance by allowing the optimum percentage of open area forward of the loudspeaker. The IHVP-CK includes the same compression driver horn found in the I8SCH-CK with the addition of a vandal resistant enclosure. This enclosure features a cast aluminum alloy baffle with a perforated 22-gauge stainless steel metal screen over the loudspeaker that maximizes protection and performance. The baffle is finished in neutral white electrostatic powder coat and is packaged with all necessary vandal resistant mounting screws.

The IDT12-CK is an in-ceiling IP speaker that includes the same speaker and controller found in the I8S-CK. This speaker features a 1" x 2" enclosure and tile support that allows it to be used in suspended ceiling applications. This style speaker is also available with an integrated microphone, model IDT12M-CK, for applications when intercom is required.



Atlas IP Speakers are Available in Several Formats to Meet the Needs of Any Installation

I8S-CK

Features

- Use With Controlkom® 2.0 or Syn-Apps SA Announce Software to Send Live, Prerecorded or Ad HOC Messages Along With Control Data to Atlas Sound IP Speaker and Zone Controller End Points Over New or Existing Multicast Enabled Local Area Networks
- Loudspeakers Are Also Compatible With SIP (Session Initiation Protocol) VoIP Systems, Contact Atlas Sound for SIP Configuration Info
- Highly Efficient 10oz Dual Cone Loudspeaker System Provides 94dB Average SPL @ 1W/1m and is Capable of 103dB @ 1 Meter Via The Rated Power of the Internal IP Addressable Amplifier
- Wide Frequency Response of 86Hz to 8kHz (-3dB) is Perfect for Speech and General Messaging Playback
- ETL Certified

Specifications

Height	1 1/2" (292mm)
Width	1 1/2" (292mm)
Depth	4 1/4" (108mm)
Connector Type	RJ-45
Safety Listing	UL60950-1



I8SM-CK

Features

- Use With Controlkom® 2.0 or Syn-Apps SA Announce Software to Send Live, Prerecorded or Ad HOC Messages Along With Control Data to Atlas Sound IP Speaker and Zone Controller End Points Over New or Existing Multicast Enabled Local Area Networks
- Built-in Microphone for Full Duplex Intercom
- Highly Efficient 10oz Dual Cone Loudspeaker System Provides 94dB Average SPL @ 1W/1m and is Capable of 103dB @ 1 Meter Via The Rated Power of the Internal IP Addressable Amplifier
- Wide Frequency Response of 86Hz to 8kHz (-3dB) is Perfect for Speech and General Messaging Playback
- ETL Certified

Specifications

Height	1 1/2" (292mm)
Width	1 1/2" (292mm)
Depth	4 1/4" (108mm)
Connector Type	RJ-45
Safety Listing	UL60950-1



I8SC-CK

Features

- Use With Controlkom® 2.0 or Syn-Apps SA Announce Software to Send Live, Prerecorded or Ad HOC Messages Along With Control Data to Atlas Sound IP Speaker and Zone Controller End Points Over New or Existing Multicast Enabled Local Area Networks
- Highly Efficient 10oz Dual Cone Loudspeaker System Provides 94dB Average SPL @ 1W/1m and is Capable of 103dB @ 1 Meter Via The Rated Power of the Internal IP Addressable Amplifier
- Network Controlled, High Visibility Red LED Clock
- Wide Frequency Response of 86Hz to 8kHz (-3dB) is Perfect for Speech and General Messaging Playback

Specifications

Height	14 $\frac{3}{8}$ " (365mm)
Width	12 $\frac{7}{8}$ " (327mm)
Depth	3" (76.2mm)
Connector Type	RJ-45
Safety Listing	UL60950-1



I8SCH-CK

Features

- Use With Controlkom® 2.0 or Syn-Apps SA Announce Software to Send Live, Prerecorded or Ad HOC Messages Along With Control Data to Atlas Sound IP Speaker and Zone Controller End Points Over New or Existing Multicast Enabled Local Area Networks
- Highly Efficient APF Horn Loudspeaker System Provides 104dB Average SPL @ 1W/1m and is Capable of 113dB @ 1 Meter Via the Rated Power of the Internal IP Addressable Amplifier
- Frequency Response of 700Hz to 5.5kHz (+/-5dB) is Perfect for High Intelligibility Speech and General Messaging Playback
- Network Controlled, High Visibility Red LED Clock
- APF Series Compression Driver

Specifications

Height	14" (356mm)
Width	12" (305mm)
Depth	4" (102mm)
Connector Type	RJ-45
Safety Listing	UL60950-1



I8SCM-CK

Features

- Use With Controlkom® 2.0 or Syn-Apps SA Announce Software to Send Live, Prerecorded or Ad HOC Messages Along With Control Data to Atlas Sound IP Speaker and Zone Controller End Points Over New or Existing Multicast Enabled Local Area Networks
- Built-in Microphone for Full Duplex Intercom
- Highly Efficient 10oz Dual Cone Loudspeaker System Provides 94dB Average SPL @ 1W/1m and is Capable of 103dB @ 1 Meter Via The Rated Power of the Internal IP Addressable Amplifier
- Network Controlled, High Visibility Red LED Clock
- Wide Frequency Response of 86Hz to 8kHz (-3dB) is Perfect for Speech and General Messaging Playback

Specifications

Height	14 $\frac{3}{8}$ " (365mm)
Width	12 $\frac{7}{8}$ " (327mm)
Depth	3" (76.2mm)
Connector Type	RJ-45
Safety Listing	UL60950-1



IHVP-CK

Features

- Use With Controlkom® 2.0 or Syn-Apps SA Announce Software to Send Live, Prerecorded or Ad HOC Messages Along With Control Data to Atlas Sound IP Speaker and Zone Controller End Points Over New or Existing Multicast Enabled Local Area Networks
- Frequency Response of 700Hz to 5.5kHz (+/-5dB) is Perfect for High Intelligibility Speech and General Messaging Playback
- Highly Efficient APF Horn Loudspeaker System Provides 104dB Average SPL @ 1W/1m and is Capable of 113dB @ 1 Meter Via the Rated Power of the Internal IP Addressable Amplifier

Specifications

Height	10 $\frac{3}{4}$ " (273mm)
Width	10 $\frac{3}{4}$ " (273mm)
Depth	4 $\frac{7}{8}$ " (123mm)
Connector Type	RJ-45
Safety Listing	UL60950-1



IDT12-CK

Features

- Use With Controlkom® 2.0 or Syn-Apps SA Announce Software to Send Live, Prerecorded or Ad HOC Messages Along With Control Data to Atlas Sound IP Speaker and Zone Controller End Points Over New or Existing Multicast Enabled Local Area Networks
- Highly Efficient 10oz Dual Cone Loudspeaker System Provides 94dB Average SPL @ 1W/1m and is Capable of 103dB @ 1 Meter Via The Rated Power of the Internal IP Addressable Amplifier
- Wide Frequency Response of 86Hz to 8kHz (-3dB) is Perfect for Speech and General Messaging Playback

Specifications

Height	23" (584mm)
Width	11" (279mm)
Depth	4" (102mm)
Sensitivity 1W/1m	94dB
Dispersion	105°
Connector Type	RJ-45
Safety Listing	UL60950-1



IDT12M-CK

Features

- Use With Controlkom® 2.0 or Syn-Apps SA Announce Software to Send Live, Prerecorded or Ad HOC Messages Along With Control Data to Atlas Sound IP Speaker and Zone Controller End Points Over New or Existing Multicast Enabled Local Area Networks
- Built-in Microphone for Full Duplex Communication
- Highly Efficient 10oz Dual Cone Loudspeaker System Provides 94dB Average SPL @ 1W/1m and is Capable of 103dB @ 1 Meter Via The Rated Power of the Internal IP Addressable Amplifier
- Wide Frequency Response of 86Hz to 8kHz (-3dB) is Perfect for Speech and General Messaging Playback

Specifications

Height	23" (584mm)
Width	11" (279mm)
Depth	4" (102mm)
Sensitivity 1W/1m	94dB
Dispersion	105°
Connector Type	RJ-45
Safety Listing	UL60950-1





Zone Controllers from Atlas Sound allow any analog devices in an installation to be connected to a network enabling it to receive paging and other content from system software like ControlKom 2.0.

Zone Controllers - ControlKom® / Syn-Apps

Applications

Atlas Sound zone controllers are ideal solutions for any installation where an IP based paging system is being deployed. A zone controller allows the connection of an analog amplifier to be controlled via the network. This is convenient and money saving in installations where an existing large speaker zone currently exists. The analog amplifier driving the zone can be connected to the network via a zone controller. This allows administrators to be able to send network messages to that speaker zone via the network without having to replace all of the speakers in that zone with higher priced IP speakers.

Features

- IP Addressable Zone Interfaces
- Single or Dual Zone Modules Available
- Balanced Line Level Output
- Rack Mountable, ½ Rack Width
- Amplified PRO Version Available

General Description

The Atlas Sound ZC1-CK is a single zone, IP addressable interface that is designed to be used in an IP paging system. Each unit contains a factory assembled PCB control board housed in a durable single RU metal chassis. This unit offers the same IP addressable end point functionality found in Atlas IP speakers. Each unit features a balanced line level output, 600Ω, that is designed to be used with Atlas Sound amplifiers to drive large analog speaker zones through the network control. The unit receives 48VDC power provided by IEEE 802.3 AF compliant POE switches (local IPS-PSU 12VDC – 18VDC PSUs may also be used instead of POE switches). Network interconnection is via a board mounted female RJ-45 connector on the front panel. Output is balanced line level via a 3 pole terminal block on the rear panel. Atlas Sound also offers a dual zone, IP addressable interface, the ZC2-CK. This unit includes the same features found on the single zone versions.

Atlas Sound also offers a “pro” version of the zone controller. This model, ZC1PRO-CK, incorporates the same balanced line level output found in the ZC1-CK but offers additional functionality. This model includes an internal 9-watt amplifier (8Ω, 25V, or 70.7V output), dual GPI inputs, dual GPI outputs, and a microphone input for use in talk back applications. The GPIs can be configured for a variety of purposes including classroom call buttons or other notifications based on installation need. This model is 2RU and ½ rack wide. This is also available in dual zone unit, the ZC2PRO-CK.



Zone Controllers Connect Analog Amplifiers to the Network Allowing Facilities to Use Non IP Speakers Where Appropriate



ZC1-CK

Features

- Use With Controlkom® 2.0 or Syn-Apps SA Announce Software to Send Live, Prerecorded or Ad HOC Messages Along With Control Data to Atlas Sound IP Speaker and Zone Controller End Points Over New or Existing Multicast Enabled Local Area Networks
- Modular 1RU Design Allows for Easy Rack Mounting and Cable Access
- Balanced Line Output to Drive Atlas Amplifiers

Specifications

Height	1½" (38.1mm)
Width	8" (203mm)
Depth	10" (254mm)
Safety Listing	UL60950-1



ZC2-CK

Features

- Use With Controlkom® 2.0 or Syn-Apps SA Announce Software to Send Live, Prerecorded or Ad HOC Messages Along With Control Data to Atlas Sound IP Speaker and Zone Controller End Points Over New or Existing Multicast Enabled Local Area Networks
- Modular 1RU Design Allows for Easy Rack Mounting and Cable Access
- Balanced Line Output to Drive Atlas Amplifiers

Specifications

Height	1¾" (44.45mm)
Width	19" (483mm)
Depth	8¾" (208mm)
Safety Listing	UL60950-1



ZC1PRO-CK

Features

- Use With Controlkom® 2.0 or Syn-Apps SA Announce Software to Send Live, Prerecorded or Ad HOC Messages Along With Control Data to Atlas Sound IP Speaker and Zone Controller End Points Over New or Existing Multicast Enabled Local Area Networks
- Modular 2RU Design Allows for Easy Rack Mounting and Cable Access
- Line Level (600Ω), 8Ω, 25V, and 70.7V Outputs
- 2GPI Contact Closure Inputs, and 2GPI Relay Outputs
- Microphone for Intercom

Specifications

Height	2.56" (65mm)
Width	8" (203mm)
Depth	10" (254mm)
Rack Space	2RU (If ZCM-V2FP is used)
Power Rating	9 Watts RMS into an 8Ω Load w/12DVC Input
Inputs	RJ-45 Female on PCB
Outputs	600Ω, 8Ω, 25V, or 70.7V
Power Source	IEEE 802.3AF compliant POE Network Switches / Local 12VDC - VDC PSU
Network Control	Multicast Enabled Networks
Relay Output	50V @ 500mA Max
Input Minimum	1mA to Run on 50V Max



ZC2PRO-CK

Features

- Use With Controlkom® 2.0 or Syn-Apps SA Announce Software to Send Live, Prerecorded or Ad HOC Messages Along With Control Data to Atlas Sound IP Speaker and Zone Controller End Points Over New or Existing Multicast Enabled Local Area Networks
- Also Compatible With SIP (Session Initiation Protocol) VoIP Systems. Contact Atlas Sound for SIP Configuration Info
- Modular 2RU Design Allows for Easy Rack Mounting and Cable Access
- Line Level (600Ω), 8Ω, 25V, and 70.7V Outputs
- 2GPI Contact Closure Inputs, and 2GPI Relay Outputs
- Microphone for Intercom

Specifications

Height	2.56" (65mm)
Width	8" (203mm)
Depth	10" (254mm)
Rack Space	2RU (If ZCM-V2FP is used)
Power Rating	9 Watts RMS into an 8Ω Load w/12DVC Input
Inputs	RJ-45 Female on PCB
Outputs	600Ω, 8Ω, 25V, or 70.7V
Power Source	IEEE 802.3AF compliant POE Network Switches / Local 12VDC - VDC PSU
Network Control	Multicast Enabled Networks
Relay Output	50V @ 500mA Max
Input Minimum	1mA to Run on 50V Max





For over 6 years Atlas Sound has offered a wide range of IP based speakers that incorporate high fidelity sound, ease of use, and worry free operation making them the ideal choice for any IP based speaker deployment.

IP Speakers - Singlewire's InformaCast

Applications

IP Speakers provide a better solution than "phone only" paging by increasing intelligibility in high noise areas and using targeted dispersion to aim sound where it truly needs to be heard. In complex zone paging scenarios IP speakers are often more economical than traditional paging speakers. IP speakers are ideal solutions for installations including education and healthcare facilities.

Features

- Safety Listed to UL60950-1
- In-Wall, In-Ceiling, and Vandal Resistant Models Available
- Models Available with Built-In Microphones for Duplex Paging Applications
- Digital Clock Versions Available with 5 Character LED Display
- Compression Horn Models Available for Higher Volume Areas
- Straight, Angled, and Flush Mount Enclosures Available

General Description

Atlas Sound model I8S includes a factory assembled loudspeaker/baffle with PCB amp/control board securely mounted to the rear of the baffle via concealed weld studs. The amp/control board is capable of producing 9 Watts RMS into the 8Ω loudspeaker with 48VDC minimum power provided by IEEE 802.3AF compliant POE switches. (local 12-18VDC PSUs may also be used instead of POE switches). Interconnection is via a board mounted female RJ-45 connector. This model include the industry standard C10A loudspeaker, which is a dual cone 8" (205mm) loudspeaker with a 10oz (260g) ceramic magnet. It includes a curve-linear paper cone for lower harmonic distortion. The loudspeaker is also equipped with a full 1" (25mm) diameter copper voice coil with aluminum former for better heat dissipation. The 18 gauge construction of the metal baffle provides security and durability in commercial applications. The baffle is finished in neutral white electrostatic powder coat and is packaged with all necessary mounting screws.

The I8SC utilizes the same speaker and control board used in the I8S but incorporates a red, 5-element LED display. This display is capable of creating numbers that are 2.75" high and 1.25" wide. This model is especially useful in school common areas like cafeterias, libraries, and multipurpose rooms. Most software applications used in conjunction with these speakers will maintain accurate time to all speakers with this feature on the network, eliminating the need for separate clocks and time required to adjust analog clocks.

The I8SM is identical to the I8S but includes an integrated microphone. This microphone allows for two-way, half duplex intercom communication. This speaker is ideal for use in a classroom where the administration and teacher may have the need to communicate directly with each other outside of a normal paging event. A unit with an integrated microphone is also available with the LED display. This model, I8SCM, is the ultimate solution for classrooms, combining the duplex paging capability with the built in clock.

The I8SCH includes a 7" compression driver horn rather than the 8" dual cone loudspeaker found in other models. This compression driver horn is capable of delivering higher volume levels making it an excellent solution for larger areas including lobbies, cafeterias, libraries, and multi-purpose rooms. This model also includes the 5-element LED display found in the I8SC. The baffle for this model includes 18 gauge construction along with a perforated 22 gauge metal screen that is provided over the loudspeaker to maximize performance by allowing the optimum percentage of open area forward of the loudspeaker. The IHVP includes the same compression driver horn found in the I8SCH with the addition of a vandal resistant enclosure. This enclosure features a cast aluminum alloy baffle with a perforated 22-gauge stainless steel metal screen over the loudspeaker that maximizes protection and performance. The baffle is finished in neutral white electrostatic powder coat and is packaged with all necessary vandal resistant mounting screws.

The I128SYS is an in-ceiling IP speaker that includes the same speaker and controller found in the I8S. This speaker features a 1" x 2" enclosure and tile support that allows it to be used in suspended ceiling applications. This style speaker is also available with an integrated microphone, model I128SYSM, for applications when intercom is required.



IP Speakers Provide an Integrated Paging Solution

I8S

Features

- Use With InformaCast® Software to Send Live, Prerecorded or Ad HOC Messages Along With Control Data to Atlas Sound IP Speaker and Zone Controller End Points Over New or Existing Multicast Enabled Local Area Networks
- Loudspeakers Are Also Compatible With SIP (Session Initiation Protocol) VoIP Systems, Contact Atlas Sound for SIP Configuration Info
- Highly Efficient 10oz Dual Cone Loudspeaker System Provides 94dB Average SPL @ 1W/1m and is Capable of 103dB @ 1 Meter Via The Rated Power of the Internal IP Addressable Amplifier
- Wide Frequency Response of 86Hz to 8kHz (-3dB) is Perfect for Speech and General Messaging Playback

Specifications

Height	11 ½" (292mm)
Width	11 ½" (292mm)
Depth	4 ¼" (108mm)
Connector Type	RJ-45
Safety Listing	UL60950-1



I8SM

Features

- Use With InformaCast® Software to Send Live, Prerecorded or Ad HOC Messages Along With Control Data to Atlas Sound IP Speaker and Zone Controller End Points Over New or Existing Multicast Enabled Local Area Networks
- Loudspeakers Are Also Compatible With SIP (Session Initiation Protocol) VoIP Systems, Contact Atlas Sound for SIP Configuration Info
- Built-in Microphone for ½ Duplex Communication
- Highly Efficient 10oz Dual Cone Loudspeaker System Provides 94dB Average SPL @ 1W/1m and is Capable of 103dB @ 1 Meter Via The Rated Power of the Internal IP Addressable Amplifier
- Wide Frequency Response of 86Hz to 8kHz (-3dB) is Perfect for Speech and General Messaging Playback

Specifications

Height	11 ½" (292mm)
Width	11 ½" (292mm)
Depth	4 ¼" (109mm)
Connector Type	RJ-45
Safety Listing	UL60950-1



I8SC

Features

- Use With InformaCast® Software to Send Live, Prerecorded or Ad HOC Messages Along With Control Data to Atlas Sound IP Speaker and Zone Controller End Points Over New or Existing Multicast Enabled Local Area Networks
- Loudspeakers Are Also Compatible With SIP (Session Initiation Protocol) VoIP Systems, Contact Atlas Sound for SIP Configuration Info
- Highly Efficient 10oz Dual Cone Loudspeaker System Provides 94dB Average SPL @ 1W/1m and is Capable of 103dB @ 1 Meter Via The Rated Power of the Internal IP Addressable Amplifier
- Network Controlled, High Visibility Red LED Clock
- Wide Frequency Response of 86Hz to 8kHz (-3dB) is Perfect for Speech and General Messaging Playback

Specifications

Height	14 $\frac{3}{8}$ " (365mm)
Width	12 $\frac{7}{8}$ " (327mm)
Depth	3" (76.2mm)
Connector Type	RJ-45
Safety Listing	UL60950-1



I8SCH

Features

- Use With InformaCast® Software to Send Live, Prerecorded or Ad HOC Messages Along With Control Data to Atlas Sound IP Speaker and Zone Controller End Points Over New or Existing Multicast Enabled Local Area Networks
- Loudspeakers Are Also Compatible With SIP (Session Initiation Protocol) VoIP Systems, Contact Atlas Sound for SIP Configuration Info
- Highly Efficient APF Horn Loudspeaker System Provides 104dB Average SPL @ 1W/1m and is Capable of 113dB @ 1 Meter Via the Rated Power of the Internal IP Addressable Amplifier
- Frequency Response of 700Hz to 5.5kHz (+/-5dB) is Perfect for High Intelligibility Speech and General Messaging Playback
- Network Controlled, High Visibility Red LED Clock
- APF Series Compression Driver

Specifications

Height	14" (356mm)
Width	12" (305mm)
Depth	4" (102mm)
Connector Type	RJ-45
Safety Listing	UL60950-1



I8SCM

Features

- Use With InformaCast® Software to Send Live, Prerecorded or Ad HOC Messages Along With Control Data to Atlas Sound IP Speaker and Zone Controller End Points Over New or Existing Multicast Enabled Local Area Networks
- Loudspeakers Are Also Compatible With SIP (Session Initiation Protocol) VoIP Systems, Contact Atlas Sound for SIP Configuration Info
- Built-in Microphone for ½ Duplex Communication
- Highly Efficient 10oz Dual Cone Loudspeaker System Provides 94dB Average SPL @ 1W/1m and is Capable of 103dB @ 1 Meter Via The Rated Power of the Internal IP Addressable Amplifier
- Network Controlled, High Visibility Red LED Clock
- Wide Frequency Response of 86Hz to 8kHz (-3dB) is Perfect for Speech and General Messaging Playback

Specifications

Height	14 $\frac{3}{8}$ " (365mm)
Width	12 $\frac{7}{8}$ " (327mm)
Depth	3" (76.2mm)
Connector Type	RJ-45
Safety Listing	UL60950-1



IHVP

Features

- Use With InformaCast® Software to Send Live, Prerecorded or Ad HOC Messages Along With Control Data to Atlas Sound IP Speaker and Zone Controller End Points Over New or Existing Multicast Enabled Local Area Networks
- Loudspeakers Are Also Compatible With SIP (Session Initiation Protocol) VoIP Systems, Contact Atlas Sound for SIP Configuration Info
- Frequency Response of 700Hz to 5.5kHz (+/-5dB) is Perfect for High Intelligibility Speech and General Messaging Playback
- Highly Efficient APF Horn Loudspeaker System Provides 104dB Average SPL @ 1W/1m and is Capable of 113dB @ 1 Meter Via the Rated Power of the Internal IP Addressable Amplifier

Specifications

Height	10 $\frac{3}{4}$ " (273mm)
Width	10 $\frac{3}{4}$ " (273mm)
Depth	4 $\frac{7}{8}$ " (123mm)
Connector Type	RJ-45
Safety Listing	UL60950-1



I128SYS

Features

- Use With InformaCast® Software to Send Live, Prerecorded or Ad HOC Messages Along With Control Data to Atlas Sound IP Speaker and Zone Controller End Points Over New or Existing Multicast Enabled Local Area Networks
- Highly Efficient 10oz Dual Cone Loudspeaker System Provides 94dB Average SPL @ 1W/1m and is Capable of 103dB @ 1 Meter Via The Rated Power of the Internal IP Addressable Amplifier
- Wide Frequency Response of 86Hz to 8kHz (-3dB) is Perfect for Speech and General Messaging Playback

Specifications

Height	23" (584mm)
Width	11" (279mm)
Depth	5" (127mm)
Sensitivity 1W/1m	94dB
Dispersion	105°
Connector Type	RJ-45
Safety Listing	UL60950-1



I128SYSM

Features

- Use With InformaCast® Software to Send Live, Prerecorded or Ad HOC Messages Along With Control Data to Atlas Sound IP Speaker and Zone Controller End Points Over New or Existing Multicast Enabled Local Area Networks
- Built-in Microphone for ½ Duplex Communication
- Highly Efficient 10oz Dual Cone Loudspeaker System Provides 94dB Average SPL @ 1W/1m and is Capable of 103dB @ 1 Meter Via The Rated Power of the Internal IP Addressable Amplifier
- Wide Frequency Response of 86Hz to 8kHz (-3dB) is Perfect for Speech and General Messaging Playback

Specifications

Height	23" (584mm)
Width	11" (279mm)
Depth	5" (127mm)
Sensitivity 1W/1m	94dB
Dispersion	105°
Connector Type	RJ-45
Safety Listing	UL60950-1





Zone Controllers from Atlas Sound allow any analog devices in an installation to be connected to a network enabling it to receive paging and other content from system software like InformaCast.

Zone Controllers - Singlewire's InformaCast

Applications

Atlas Sound zone controllers are ideal solutions for any installation where an IP based paging system is being deployed. A zone controller allows the connection of an analog amplifier to be controlled via the network. This is convenient and money saving in installations where an existing large speaker zone currently exists. The analog amplifier driving the zone can be connected to the network via a zone controller. This allows administrators to be able to send network messages to that speaker zone via the network without having to replace all of the speakers in that zone with higher priced IP speakers.

Features

- IP Addressable Zone Interfaces
- Single or Dual Zone Modules Available
- Balanced Line Level Output
- Rack Mountable, ½ Rack Width
- Amplified PRO Version Available

General Description

The Atlas Sound ZC1 is a single zone, IP addressable interface that is designed to be used in an IP paging system. Each unit contains a factory assembled PCB control board housed in a durable single RU metal chassis. This unit offers the same IP addressable end point functionality found in Atlas IP speakers. Each unit features a balanced line level output, 600Ω, that is designed to be used with Atlas Sound amplifiers to drive large analog speaker zones through the network control. The unit receives 48VDC power provided by IEEE 802.3 AF compliant POE switches (local IPS-PSU 12VDC – 18VDC PSUs may also be used instead of POE switches). Network interconnection is via a board mounted female RJ-45 connector on the front panel. Output is balanced line level via a 3 pole terminal block on the rear panel. Atlas Sound also offers a dual zone, IP addressable interface, the ZC2. This unit includes the same features found on the single zone versions.

Atlas Sound also offers a "pro" version of the zone controller. This model, ZC1PRO, incorporates the same balanced line level output found in the ZC1 but offers additional functionality. This model includes an internal 9-watt amplifier (8Ω, 25V, or 70.7V output), dual GPI inputs, dual GPI outputs, and a microphone input for use in talk back applications. The GPIs can be configured for a variety of purposes including classroom call buttons or other notifications based on installation need. This model is 2RU and ½ rack wide. This is also available in dual zone unit, the ZC2PRO.



Zone Controllers Allow Network Control of Higher Powered Amplifiers and Speakers in Locations Where Required



ZC1

Features

- Use With InformaCast® Software to Send Live, Prerecorded or Ad HOC Messages Along With Control Data to Atlas Sound IP Speaker and Zone Controller End Points Over New or Existing Multicast Enabled Local Area Networks
- Modular 1RU Design Allows for Easy Rack Mounting and Cable Access
- Balanced Line Output to Drive Atlas Amplifiers

Specifications

Height	1½" (38.1mm)
Width	8" (203mm)
Depth	10" (254mm)
Safety Listing	UL60950-1



ZC2

Features

- Use With InformaCast® Software to Send Live, Prerecorded or Ad HOC Messages Along With Control Data to Atlas Sound IP Speaker and Zone Controller End Points Over New or Existing Multicast Enabled Local Area Networks
- Modular 1RU Design Allows for Easy Rack Mounting and Cable Access
- Balanced Line Output to Drive Atlas Amplifiers

Specifications

Height	1¾" (44.45mm)
Width	19" (483mm)
Depth	8¾" (208mm)
Safety Listing	UL60950-1



ZC1PRO

Features

- Use With InformaCast® Software to Send Live, Prerecorded or Ad HOC Messages Along With Control Data to Atlas Sound IP Speaker and Zone Controller End Points Over New or Existing Multicast Enabled Local Area Networks
- Also Compatible With SIP (Session Initiation Protocol) VoIP Systems. Contact Atlas Sound for SIP Configuration Info
- Modular 2RU Design Allows for Easy Rack Mounting and Cable Access
- Line Level (600Ω), 8Ω, 25V, and 70.7V Outputs
- 2GPI Contact Closure Inputs, and 2GPI Relay Outputs
- Microphone for Intercom



Specifications

Height	2.56" (65mm)
Width	8" (203mm)
Depth	10" (254mm)
Rack Space	2RU (If ZCM-V2FP is used)
Power Rating	9 Watts RMS into an 8Ω Load w/12DVC Input
Inputs	RJ-45 Female on PCB
Outputs	600Ω, 8Ω, 25V, or 70.7V
Power Source	IEEE 802.3AF compliant POE Network Switches / Local 12VDC - VDC PSU
Network Control	Multicast Enabled Networks
Relay Output	50V @ 500mA Max
Input Minimum	1mA to Run on 50V Max



ZC2PRO

Features

- Use With InformaCast® Software to Send Live, Prerecorded or Ad HOC Messages Along With Control Data to Atlas Sound IP Speaker and Zone Controller End Points Over New or Existing Multicast Enabled Local Area Networks
- Also Compatible With SIP (Session Initiation Protocol) VoIP Systems. Contact Atlas Sound for SIP Configuration Info
- Modular 2RU Design Allows for Easy Rack Mounting and Cable Access
- Line Level (600Ω), 8Ω, 25V, and 70.7V Outputs
- 2GPI Contact Closure Inputs, and 2GPI Relay Outputs
- Microphone for Intercom

Specifications

Height	2.56" (65mm)
Width	8" (203mm)
Depth	10" (254mm)
Rack Space	2RU (If ZCM-V2FP is used)
Power Rating	9 Watts RMS into an 8Ω Load w/12DVC Input
Inputs	RJ-45 Female on PCB
Outputs	600Ω, 8Ω, 25V, or 70.7V
Power Source	IEEE 802.3AF compliant POE Network Switches / Local 12VDC - VDC PSU
Network Control	Multicast Enabled Networks
Relay Output	50V @ 500mA Max
Input Minimum	1mA to Run on 50V Max





Classrooms equipped with sound reinforcement solutions benefit teachers, students, and the education system as a whole.

Atlas Learn

Applications

The Atlas Learn system is an in-classroom sound reinforcement solution designed for use in K-12 and higher education facilities or where a room constrained public address system is required. Atlas Learn solutions include amplifiers/receivers, wireless microphones, docking stations, and related accessories.

Features

- Compact Design
- Infrared Transmission
- Rechargeable Wireless Handsets
- Integrated "Panic" Feature
- System Options Available

General Description

The Atlas Sound AL2430 coordinates all of the functions of the Atlas Learn system and brings all of the features together for a single unit control center. This infrared receiver/amplifier is capable of delivering up to 30 watts of power (8Ω, 25V, or 70.7V) and features Atlas Sound's patent pending through chassis design. This feature allows the unit to be mounted to a pole in conjunction with a projector or other equipment if security is a concern. The front of the unit features a main power switch and volume controls for two microphones (A and B), as well as four other external audio sources like Computer, TV, CD, or Auxiliary audio.

The rear panel of the AL2430 has all of the connections and adjustments needed to set up the Atlas Learn system to maximize its efficacy in any size classroom. The AL2430 can support up to three infrared (IR) domes that receive the signal from the wireless microphones and transmit that signal back to the amplifier for playing through the speakers in the classroom. Additionally the AL2430 has equalization adjustments for the microphones to optimize their sound quality, a priority page input that allows the local audio to be overridden when a page is initiated by the administration, and a line output for connection to an external amplifier, recording device, or hearing assistance system based on the classroom requirements.

The Atlas Sound AL-EAGLE is a two-channel infrared dome receiver that is designed to work with Atlas Learn infrared microphones, AL-MAGPIE and AL-MYNA. The AL-EAGLE connects via RCA output to almost any local audio amplifier. The AL-EAGLE also features a contact closure output that can be connected to a secondary system allowing the teacher to signal an emergency situation in the classroom using the "Panic" feature on the AL-MAGPIE or AL-MYNA wireless transmitters (in "teacher" mode only). For larger rooms, the AL-EAGLE has an F-pin style input connector that can be used with a secondary infrared wireless dome, AL-IRDS, if needed. Volume controls for the two wireless transmitters are located on the side of the AL-EAGLE to properly set or adjust transmitter volume internally mixing the two channels for output to the amplifier. Three LEDs are located on the front of the unit and act as visual indicators for system power and connection.

There are two wireless infrared microphones that work in the Atlas Learn system, the AL-MAGPIE and AL-MYNA. Each unit delivers high quality, wireless audio to either the AL2430 or AL-EAGLE receivers. Each Atlas Learn Amplified Learning system can support up to two wireless microphones and they can be mixed and matched within the same system. The infrared technology does not interfere with computer wireless networks and it does not pass through walls so it cannot interfere with other classroom system deployments. The microphones can be set to either "A" or "B", additionally one can be locked out to function as a student microphone with limited functionality if needed. Each wireless microphone has a volume control for adjusting the volume of that microphone relative to the user's voice allowing it to be adjusted up or down so that the speaker can be clearly heard and understood. One of the most unique features of the Atlas Learn wireless microphones is their incorporation of a "PANIC" feature. This panic feature allows a teacher to signal the administration or security office in the event that an emergency situation arises in the classroom. Both the AL-MAGPIE and AL-MYNA also include breakaway lanyards and work with a docking station that recharges the units' batteries.

Classrooms equipped with sound reinforcement solutions benefit teachers, students, and the education system as a whole. With even sound distribution, lessons are easily heard no matter where students are seated. Attention and concentration are raised, especially in the back of the room. Teachers no longer strain their voices and the system can easily integrate with existing in-classroom multimedia teaching tools such as computers and DVD players for a single source audio control.



Atlas Learn Wireless Infrared Transmitters are Easy to Use and Help Improve the Intelligibility of the Spoken Word

AL2430

Features

- 6 Input Mixer with Priority Page Override
- Front Panel Source Volume Control
- Supports Up To Three Infrared Wireless Transmitters
- Works with Both Atlas Learn AL-MAGPIE and AL-MYNA Wireless Infrared Microphones

Specifications

Power Output	30 Watts RMS (8Ω, 25V, 70V Output)
Multimedia Input Sensitivity	-10dB
Priority Page Input Sensitivity	14dB
Computer Input Impedance	56K
Multimedia Input Impedance	22K
Multimedia Input Connector Type	(4) Dual RCA
AUX Front Input Connector Type	3.5mm
Line Output Impedance	1K
Line Output Voltage	1.3V
Line Output Connector Type	Dual RCA
Mic EQ	(100Hz, 3kHz, & 10kHz) Adjustment±10dB
IR Input Impedance / Connector Type	75Ω F Connector
Panic Output Contact	Rating 5A @ 36V
Height	1¾" (45mm)
Width	8½" (216mm)
Depth	13½" (343mm)
Receiver Weight	5.75 lbs (2.6kg)
UL Listed Power Supply	100-240V (50/60Hz) 1.7A In/ 24VDC 2.5A out



AL-MAGPIE

Features

- Ultra Compact Wireless IR Classroom Microphone Weighs Only 2.24 Oz
- Integrated Soft Touch Controls Include Power, Volume, and Panic
- Rechargeable Battery Included
- Up To 8 Hours of Use Between Charges
- Includes Breakaway Lanyard

Specifications

IR LEDs	6
Headset/AUX Input	1, 3.5mm Phono Jack, Mic Level
External Controls	Mic Volume Up/Down, Power, "Panic"
Internal Controls	Lockout, Mic A/B Channel
Height	3 ⁹ / ₁₆ " (97mm)
Width	1 ¹ / ₈ " (29mm)
Depth	1" (25mm)
Weight (with Battery)	2.24 oz. (65g)
Weight (without Battery)	1.28 oz (36g)
Battery (included)	(1) LIR17500 Lithium-ion (3.7V)



AL-MYNA

Features

- Wireless IR Classroom Microphone
- Integrated Soft Touch Controls Include Power, Volume, and Panic
- Integrated Belt Clip
- Includes Breakaway Lanyard With ID Clip and Rechargeable AA Batteries

Specifications

IR LEDs	6
Headset/AUX Input	1, 3.5mm Phono Jack, Mic Level
External Controls	Mic Volume Up/Down, Power, "Panic"
Internal Controls	Lockout, Mic A/B Channel
Height	5 ³ / ₁₆ " (132mm)
Width	1 ⁹ / ₁₀ " (45.7mm)
Diameter	1 ⁵ / ₁₆ " (33mm)
Depth	1" (25mm)
Weight (with Battery)	2.24 oz. (65g)
Weight (without Battery)	1.28 oz (36g)
Battery (included)	(Z) Type AA NiMH Rechargeable



AL-MAGPIE Charging Station

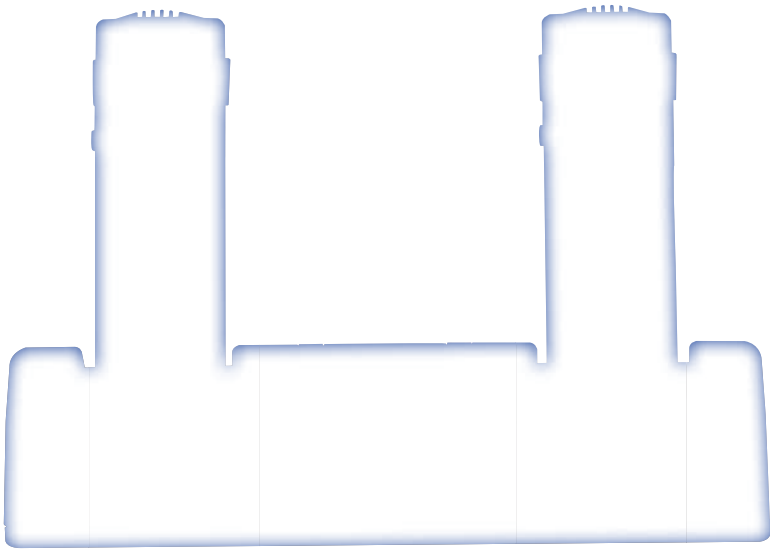

Features

- The Remote Charging/Docking Station for AL-MAGPIE Wireless Infrared Microphones.
- Dual Dock to Fit Two AL-MAGPIE Remotes
- Ability to Charge Both AL-MAGPIE Remotes Simultaneously

Specifications

Height	1.75" (44mm)
Width	6.5" (165mm)
Depth	2.75" (70mm)
Weight	.125 lbs (.06kg)
AL-MAGPIE Ports	Two Charging Ports
Charge Indicator LEDs	Two Charge Indicator LEDs
UL Listed Power Supply	100-240V (50/60Hz) .2A In/ .5VDC 1A out

AL-MYNA Charging Station



Features

- The Remote Charging/Docking Station For AL-MYNA Wireless Infrared Microphones.
- Dual Dock to Fit Two AL-MYNA Remotes
- Ability to Charge Both AL-MYNA Remotes Simultaneously

Specifications

Height	4.17" (106mm)
Width	7.44" (189mm)
Depth	2.75" (70mm)
Weight	.5 lbs (.23kg)
AL-MYNA Ports	2
Charge Indicator LEDs	4 (Red – Charging, Green –Charged)
UL Listed Power Supply	100-240V (50/60Hz) .5A In/ .9VDC 1.5A out

AL-MAGPIE Lanyard

Features

- Magnetic Safety Breakaway Connection for Easy and Quick Removal



AL-MYNA Lanyard

Features

- Breakaway Safety Release
- Includes an ID Badge Clip



AL-IRDS

Features

- 10m of UL Listed, F-Style Termination, RG6 Type Cable Included



AL-CM

Features

- Adjustable Microphone
- 3.5mm Mini Connection



AL-HSM

Features

- Fixed Position Microphone
- 3.5mm Mini Connection

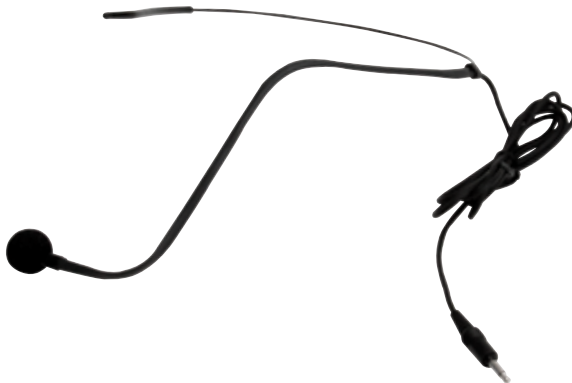

AL-LM

Features

- 3.5mm Mini Connection





A GLOBALCOM system from Innovative Electronic Designs is an all-encompassing system that manages the public address, visual messaging, and mass notification and emergency messaging functions for facilities of all sizes. This fully scalable system can be deployed to manage systems with as few as a dozen zones to systems that have over 65,000 zones.

GLOBALCOM

Applications

GLOBALCOM is an Announcement Control System that is network-centric eliminating the need for large head-end equipment room installations. It moves processing and intelligence to the edge of the network, yet maintains overall system control and management at the core. This innovative distribution system simplifies installation and significantly reduces costs by integrating with industry-standard structured cabling and network infrastructure. GLOBALCOM systems can be deployed in education campuses, healthcare facilities, industrial complexes, and transportation centers of any size.

Features

- Each Announcement Controller Can Manage Up to 250 Microphone Stations and 65,536 Zone Outputs
- Flexible Announcement Delivery Utilizing Live, Delayed, and Pre-Recorded Messages
- Optional Text-to-Speech Engine Capable of Generating Announcements In Multiple Languages
- Automatic Level Adjustments Based on the Ambient Noise Level
- New Event Messaging Allows Multiple Actions to Be Tied to a Single Event That Can be Triggered From a Microphone Station or External Device
- Seamless Integration with Existing IED 510/520ACS Installations
- Enhanced Device-Specific Page Control
- 65,535 Levels Of Announcement Priority
- Up to 180 Simultaneous Announcements and Messages Can Be Made on a Single LAN or VLAN
- Incident-Specific Instructions Can be Programmed to Appear on Displays
- Flexible Emergency Announcement Capability Such as System Muting, Multiple Evacuation Messages, and Visual Emergency Message Display
- Easy System Backup and Restoration of Configuration Files
- Easy-to-Use vACS Control Console for System Configuration
- Built-In Wizards to Assist in Application-Specific System Configuration
- Integrated Support for Visual Paging for Enhanced Message Delivery and ADA Compliance



500ACS



8000 SERIES



508HFM

500HFM



MODEL 540



General Description

Through over 30 years of announcement system experience, IED has learned that flexibility in design is critical. Not only does each individual system have its own requirements, but every system must be able to adapt and change as functionality and priorities evolve. No matter the size, space, or complexity of the announcement system required, GLOBALCOM is suited to fit the application with superior reliability, easy installation, and a simplified user interface.

At the heart of GLOBALCOM is a set of core building block components used to construct a system of the appropriate size and functionality needed for the application. Systems can range from small to very large. A small and simple system may consist of a single announcement controller with integrated messaging and a small number of input and output devices. Larger systems are built using multiple announcement controllers linked together to function as a single system with thousands of outputs.

GLOBALCOM utilizes standard network infrastructure for all audio and control transmissions. Audio is passed between devices on a local area network (LAN) utilizing Layer 2 CobraNet®. GLOBALCOM contains the enhanced capability of transmitting and receiving audio between LANs or VLANs by transmitting full bandwidth audio in real time utilizing routable Layer 3 protocols. This enables a complete system to be created on a Wide Area Network (WAN) that spans much larger geographic locations. GLOBALCOM offers a significant improvement in both audio quality and overall system performance over traditional VoIP systems.

IED is leading the way for integrated auditory and visual paging systems for all-encompassing paging and message delivery. VIS works with the 1000vACS and 510/520ACS to automatically deliver fully synchronized visual text messages to visual display devices such as LCD flat panel displays or LED signs. When not actively used for a visual announcement, displays can be programmed to showcase a variety of content such as public service announcements or advertising. Adding VIS to a system assists facilities in compliance with the Americans with Disabilities Act (ADA) by providing a system with the highest degree of message comprehension.

The text-to-speech courtesy announcement system (T-CAS) is a client/server web application that manages the creation and delivery of courtesy and other ad-hoc messages. Messages are created through the web interface and either recorded from a microphone station or generated using the text-to-speech engine. The message can play multiple times and appear on bulletin board displays located throughout the facility. Each message is stored in a database for easy retrieval by multiple operators.



**1100ACS
Announcement Controller**



A GLOBALCOM Solution Can Handle All the Messaging Needs of Transportation Facilities



Multi-Building Convention Centers Are Ideal Applications for GLOBALCOM Systems

Parts in the GLOBALCOM Family Include:

Hardware

- 1100ACS-32 - Announcement Control System with Integrated Messaging and 32-Zone License
- 1200ACS-32 - Announcement Control System with Messaging, Telephone Interface, 8 Logic Inputs, 8 Relay Outputs, and 32-Zone License
- 1100MSG - 8-Channel Message Server For Capacity Expansion Or Use With Server-Based 1000vACS
- 1200MSG - Enhanced 8-channel Message Server With Telephone Interface, 8 Logic Inputs, And 8 Relay Outputs
- 1300CBN - CobraNet Bridge For Linking GLOBALCOM and IED 510ACS and 520ACS Systems Across Different Networks (LAN/VLAN)
- 1112PS - 37A, 12V DC rack Mount Power Supply Unit With Redundancy Option
- 1914TEL-V - Telephone Interface Server With Capacity For 8 VoIP Lines
- 1920REC - System Audio Recorder For 16 Audio Channels Accessories
- 112PSM - Redundant Power Supply Module for 1112PS
- 1112PSD - 4 Amp 12V DC Modular Power Supply For Single GLOBALCOM Devices
- 1530ALR - Audio And Control Interface Module With 2 Audio Inputs, 2 Audio Outputs, 4 Logic Inputs, And 4 Relay Outputs
- 1502AI - SmartLink InX2 Audio Input Module, 2 Channels
- 1502AO - SmartLink OutX2 Audio Output Module, 2 Channels



Get the most out of your system with cabling and connections with Atlas Signal. These cables incorporate several technologies that eliminate noise and interference all while making it easy to connect key equipment in any installation.



Atlas Signal Cables Provide Integrators a Solution for Connecting All The Devices in Many Installation Scenarios

Cables

Applications

Atlas Signal cables are designed to connect audio and video devices in common installation scenarios in order to maximize performance while minimizing cost. Atlas Signal offers several types of cables including HDMI, Component Video, HDMMA, XLR, and RCA as well as three types of Phoenix style adapters. These cables are ideal for use in conference rooms, luxury suites, classrooms, and equipment racks used in any installation.

Features

- Accu-Grain OFC Copper Conductor
- PolyFlex Outer Jacket
- Intelli-Connect Labeling
- SureGrip Custom Molded Mini Connector

General Description

Atlas Signal products solve some of the most commonly encountered installation problems faced by integrators and installers on a daily basis. Atlas Signal video cables include HDMI, Component Video, and HDMMA available in multiple lengths. Each cable uses proven technologies to eliminate interference and deliver crystal clear video reproduction. Atlas Signal video cables are easily added to any Atlas Sound order.

Atlas Signal audio cables include XLR and RCA Interconnects commonly encountered during installations. Additionally, Atlas Signal includes an unbalanced RCA to Phoenix style connector, an unbalanced passive summing cable with Phoenix style connector, and a balanced XLR to Phoenix style connector. Each of these units can be used in several difference scenarios and are designed to save integrators and installers time and money.



AS2HDMMA



AS2HDMI-1M



AS2HDMI High Definition Multimedia Interface

Features

- PolyFlex Outer Jacket Protects the Internal Wiring
- Accu-Grain OFC Copper Conductor Ensures A High Level of Signal Transfer
- Class III Shielding Protects Against Electromagnetic and RF Interference

Specifications

Length	3.28' (1M) - AS2HDMI-1M 6.56' (2M) - AS2HDMI-2M 9.94' (3M) - AS2HDMI-3M 29.53' (9M) - AS2HDMI-9M 49.21' (15M) - AS2HDMI-15M
Connector Type	HDMI Type A
Cable Type	PolyFlex
HDMI Specification	1.4 High Speed - No Ethernet
Conductor Size	28 AWG



AS2C Component Video

Features

- PolyFlex Outer Jacket Protects the Internal Wiring
- Accu-Grain OFC Copper Conductor Ensures a High Level of Signal Transfer
- Class III Shielding Protects Against Electromagnetic and RF Interference

Specifications

Length	3.28' (1M) AS2C-1M 6.56' (2M) AS2C-2M 9.94' (3M) AS2C-3M
Connector Type	Male RCA
Cable Type	PolyFlex



AS2HDMMA 15 Pin VGA Connector

Features

- PolyFlex Outer Jacket Protects the Internal Wiring
- Accu-Grain OFC Copper Conductor Ensures a High Level of Signal Transfer
- Class III Shielding Protects Against Electromagnetic and RF Interference

Specifications

Length	6.56' (2M) AS2HDMMA-2M 26.25' (9M) AS2HDMMA-9M 49.21' (15M) AS2HDMMA-15M
Connector Type	Male HD15, 3.5mm TRS
Cable Type	PolyFlex



XLR Cable

Features

- Custom Molded Sure Grip Mini Connector
- PolyFlex Outer Jacket Protects the Internal Wiring
- Accu-Grain OFC Copper Conductor Ensures A High Level of Signal Transfer

Specifications

Length	9.84' (3M) AS2XLR-3M 32.75' (10M) AS2XLR-10M 49.21' (15M) AS2XLR-15M
Connector Type	Male to Female XLR
Cable Type	PolyFlex



Male RCA to Phoenix Style Cable

Features

- Custom Molded Sure Grip Mini Connector
- PolyFlex Outer Jacket Protects the Internal Wiring
- Accu-Grain OFC Copper Conductor Ensures A High Level of Signal Transfer

Specifications

Length	3.28' (1M) AS2RCA-1M-PHX 6.56' (2M) AS2RCA-2M-PHX 9.94' (3M) AS2RCA-3M-PHX
Connector Type	Male RCA to 3 Pole Phoenix Type
Cable Type	PolyFlex



Unbalanced RCA Interconnect Cable

Features

- Custom Molded Sure Grip Mini Connector
- PolyFlex Outer Jacket Protects the Internal Wiring
- Accu-Grain OFC Copper Conductor Ensures A High Level of Signal Transfer

Specifications

Length	3.28' (1M) AS2A-1M 6.56' (2M) AS2A-2M
Connector Type	Male RCA
Cable Type	PolyFlex



AS2PHX-1M-XLR XLR to Phoenix Style Cable

Features

- Custom Molded Sure Grip Mini Connector
- PolyFlex Outer Jacket Protects the Internal Wiring
- Accu-Grain OFC Copper Conductor Ensures A High Level of Signal Transfer

Specifications

Length	3.28' (1M)
Connector Type	XLR to Phoenix Style
Cable Type	PolyFlex
Pin Configuration	1 is Shield, 2 is "Hot", 3 is Common



AA-YSUM

Features

- Uses 3 Resistor Network to Sum Stereo Audio Signals to Mono
- Includes 2 Male RCA Connectors and 1 Three Pole Male Phoenix Style Connector

Specifications

Length	3.28' (1M)
Connector Type	2 Male RCA to 3 Pole Phoenix Type
Cable Type	PolyFlex





Atlas Sound XLR, NL4MP, TRS, and GH wall plates offer a variety of installation solutions.

Wall Plates and Floor Boxes

Applications

Professional appearance and ease of use are achieved using the variety of wall plates that available through Atlas Sound for applications including auditoriums, conference rooms, ballrooms, and other applications where microphones, cables, or speaker connections are required.

Features

- Wall Plates and Floor Boxes
- Single Gang Box Installation

General Description

Atlas Sound offers both single and dual XLR wall plates in both male and female connector configurations. These plates are designed to provide wall access for microphones, speakers, or other devices that require an XLR connection to a remote mixer or amplifier. Additionally, Atlas offers an HXLP cable connector in both male and female configurations for connecting XLR and A3 style connectors.

Additionally Atlas offers single and dual NL4MP wall plates for remote connection of speakers or other devices that need to be remotely connected to required components. The SG-QTRSL-F2 features two female locking TRS connectors. The SG-38GH is designed to allow through wall routing of 3/8" cabling from remote components for easy connection.

The FB4-XLRF floor box assembly provides a simple solution for recessed mic inputs. The unit is designed for easy installation into wood stages and platforms. (4) Female XLR connectors are recessed and slant loaded into the enclosure. A hinged steel cover plate provides protection for cable connectors. Connectors are standard "D sub" type and may be easily removed to allow substitution of other "D sub" devices. May be used in concrete pour applications with the optional FB4CPB pour box.

FB4XLRF

Features

- Attractive Black Finish
- Hinged Steel Cover To Protect Cable Connectors
- Preloaded With 4 XLRF "D Sub" Style Connectors

Specifications

Height	7.94" (201.6mm)
Width	7.94" (201.6mm)
Depth	2 5/8" (66.6mm)
Shipping Weight	4.00 lbs (1.81 kgs)



Atlas Wall and Floor Plates Provide Flexibility for Room Configuration and Use



FB4CPB

Features

- 16GU Construction
- Durable Galvanized Steel Construction
- Four Compound Combination Knockouts (1/2" - 3/4", 13 - 19mm)
- Unpainted Finish

Specifications

Height	6 1/8" (156mm)
Width	6 1/8" (156mm)
Depth	4" (101.6mm)
Shipping Weight	4.00 lbs (1.81 kgs)



HXLP-3-12

Features

- A3M or Equal
- Cable Connector
- Male 3 Conductor

Specifications

Connector Type	A3M
Shipping Weight	0.22 lbs (0.10 kgs)



HXLP-3-11

Features

- A3F or Equal
- Cable Connector
- Female 3 Conductor

Specifications

Connector Type	A3F
Shipping Weight	0.50 lbs (0.23 kgs)



SG-XLR-F1

Features

- Female 3 Conductor
- Perfect for Remote Microphone Applications
- Wall / Panel Receptacle

Specifications

Height	4 3/4" (121mm)
Width	2 15/16" (532mm)
Shipping Weight	0.50 lbs (0.23 kgs)



SG-XLR-F2

Features

- 2 Female 3 Conductors
- Perfect for Remote Microphone Applications
- Wall / Panel Receptacle

Specifications

Height	4¾" (121mm)
Width	2⅝" (532mm)
Shipping Weight	0.50 lbs (0.23 kgs)



SG-XLR-M1

Features

- Male 3 Conductors
- Perfect for Remote Microphone Applications
- Wall / Panel Receptacle

Specifications

Height	4¾" (121mm)
Width	2⅝" (532mm)
Shipping Weight	0.50 lbs (0.23 kgs)



SG-XLR-M2

Features

- 2 Male 3 Conductors
- Perfect for Remote Microphone Applications
- Wall / Panel Receptacle

Specifications

Height	4¾" (121mm)
Width	2⅝" (532mm)
Shipping Weight	0.50 lbs (0.23 kgs)



SG-38GH

Features

- ⅜" Hole and Grommet
- Perfect for Applications When Cabling Needs to Penetrate Walls
- Wall / Panel Receptacle

Specifications

Height	4¾" (121mm)
Width	2⅝" (532mm)
Shipping Weight	0.50 lbs (0.23 kgs)



SG-NL4MP-1

Features

- NL4MP 4 Pole Connector
- Perfect for Remote Speaker Level Input/Output Applications
- Wall / Panel Receptacle

Specifications

Height	4¾" (121mm)
Width	2 ¹⁵ / ₁₆ " (532mm)
Shipping Weight	0.50 lbs (0.23 kgs)



SG-NL4MP-2

Features

- 2 NL4MP 4 Pole Connectors
- Perfect for Remote Speaker Level Input/Output Applications
- Wall / Panel Receptacle

Specifications

Height	4¾" (121mm)
Width	20 ¹⁵ / ₁₆ " (532mm)
Shipping Weight	0.50 lbs (0.23 kgs)



SG-QTRSL-F1

Features

- 1 Female Locking TRS Connector
- Perfect for Remote Microphone Applications
- Wall / Panel Receptacle

Specifications

Height	4¾" (120.65mm)
Width	2 ¹⁵ / ₁₆ " (531.813mm)
Shipping Weight	0.50 lbs (0.23 kgs)



SG-QTRSL-F2

Features

- 2 Female Locking TRS Connectors
- Perfect for Remote Microphone Applications
- Wall / Panel Receptacle

Specifications

Height	4¾" (121mm)
Width	2 ¹⁵ / ₁₆ " (532mm)
Shipping Weight	0.50 lbs (0.23 kgs)





For over 75 years Atlas Sound mic stands have been the choice for professional musicians worldwide. Atlas Sound MS mic stands have been on some of the hottest stages with the greatest artists in the history of music.



MS-10C Flying On Stage During a Live Performance

MS Series Mic Stands

Applications

Atlas Sound MS mic stands are the ideal choice for both studio and live performers. These mic stands offer several height options, all which include the famous Atlas Sound wear-resistant clutch, and low profile, highly stable base that ensures they are going to stay upright and where the artist wants them.

Features

- Ideal for Studio, Recording, and Performance Applications
- Wear-Resistant, 3-Piece Clutch
- Low Profile Cast Iron Base
- Field Serviceable Parts

General Description

The Atlas Sound MS43E is a 3 section, adjustable microphone stand assembly with two wear-resistant clutches for optimum vertical height adjustment and high stability. This unit is adjustable from 25" to 65" and features a 12" diameter, low-profile cast iron base finished in ebony.

The MS-10C/MS-10CE are 2 section, all purpose microphone stands featuring a wear proof clutch for easy height adjustment. The 10" die cast base features edge concentrated weight distribution and is equipped with rubber pads to absorb shock and protect floor surfaces. The 5/8" and 7/8" diameter tubing is fully adjustable with a vertical extension ranging from 35" to 63". Tubing is manufactured of cold rolled steel and terminates in the industry standard 5/8" - 27 thread, suitable for microphone clips and accessories. Top and bottom lock-nut rings are included for versatile and secure positioning. Units are available in chrome or non-reflective ebony.

The MS-12C/MS-12CE are 2 section, all purpose microphone stands featuring a wear proof clutch for easy height adjustment. These units include a low profile 10" die cast base. The 5/8" and 7/8" diameter tubing is fully adjustable with a vertical extension ranging from 35" to 63". Tubing is manufactured of cold rolled steel and terminates in the industry standard 5/8" - 27 thread, suitable for microphone clips and accessories. Top and bottom lock-nut rings are included for versatile and secure positioning. Units are available in chrome or non-reflective ebony.

The MS20/MS20E are 2 section, heavy duty microphone stands designed to provide extra stability in both indoor and outdoor applications. These units include a 12" die cast base. The 7/8" and 1-1/8" diameter tubing is fully adjustable with a vertical extension ranging from 37" to 66". Tubing is manufactured of cold rolled steel and terminates in the industry standard 5/8" - 27 thread, suitable for microphone clips and accessories. Units are available in chrome or non-reflective ebony.

The MS25/MS25E are 2 section, heavy duty, professional grade microphone stands. The key feature of these stands is the integrated air suspension system that is designed to protect sensitive microphones, especially in recording applications. The 15" triangular cast iron base is designed to provide maximum stability. The 7/8" and 1-1/8" diameter tubing is fully adjustable with a vertical extension ranging from 38" to 62". Tubing is manufactured of cold rolled steel and terminates in the industry standard 5/8" - 27 thread. Units are available in chrome or non-reflective ebony.



MS43E

Features

- Wear-Resistant, 3-Piece Clutch Offers Secure, Fast, & Noise-Free Height Adjustment
- Non-Reflective Ebony Epoxy
- Air Suspension System

Specifications

Height Span	25" - 65" (640-1650mm)
Base Size	12" dia. (305mm)
Tube Finish	Ebony
Base Finish	Ebony





MS-10C

Features

- Economical, Industry Standard Floor Stands Suitable for a Variety of Applications
- Edge-Concentrated, One-Piece Circular Base Ensures Maximum Stability
- Wear-Resistant, Three-Piece Clutch Offers Secure, Fast, and Noise-Free Height Adjustment

Specifications

Height Span	35" - 63" (890-1600mm)
Base Size	10" dia. (250mm)
Tube Finish	Chrome
Base Finish	Ebony



MS-10CE

Features

- Economical, Industry Standard Floor Stands Suitable for a Variety of Applications
- Edge-Concentrated, One-Piece Circular Base Ensures Maximum Stability
- Wear-Resistant, Three-Piece Clutch Offers Secure, Fast, and Noise-Free Height Adjustment

Specifications

Height Span	35" - 63" (890-1600mm)
Base Size	10" dia. (250mm)
Tube Finish	Ebony
Base Finish	Ebony



MS-12C

Features

- Circular Cast Iron Base Ensures Maximum Stability
- Economical, General Purpose Floor Stands Suitable for a Variety of Applications
- Wear-Resistant, Three-Piece Clutch Offers Secure, Fast, and Noise-Free Height Adjustment

Specifications

Height Span	34" - 62" (860-1580mm)
Base Size	10" dia. (250mm)
Tube Finish	Chrome
Base Finish	Ebony



MS-12CE

Features

- Circular Cast Iron Base Ensures Maximum Stability
- Economical, General Purpose Floor Stands Suitable for a Variety of Applications
- Wear-Resistant, Three-Piece Clutch Offers Secure, Fast, and Noise-Free Height Adjustment

Specifications

Height Span	34" - 62" (860-1580mm)
Base Size	10" dia. (250mm)
Tube Finish	Ebony
Base Finish	Ebony



MS20

Features

- Circular Cast Iron Base Ensures Maximum Stability
- Wear-Resistant, Three-Piece Clutch Offers Secure, Fast, and Noise-Free Height Adjustment
- Air Suspension System

Specifications

Height Span	37" - 66" (940-1680mm)
Base Size	12" dia. (300mm)
Tube Finish	Chrome
Base Finish	Ebony



MS20E

Features

- Circular Cast Iron Base Ensures Maximum Stability
- Wear-Resistant, Three-Piece Clutch Offers Secure, Fast, and Noise-Free Height Adjustment
- Air Suspension System

Specifications

Height Span	37" - 66" (940-1680mm)
Base Size	12" dia. (300mm)
Tube Finish	Ebony
Base Finish	Ebony



MS25

Features

- Receive Maximum Stability of Triangular and Oversized Bases with Edge- Concentrated Weight Distribution
- Wear-Resistant, Three-Piece Clutch Offers Secure, Fast, and Noise-Free Height Adjustment
- Air Suspension System

Specifications

Height Span	38" - 67" (970-1700mm)
Base Size	15" tri. (380mm)
Tube Finish	Chrome
Base Finish	Ebony w/ Chrome Cover

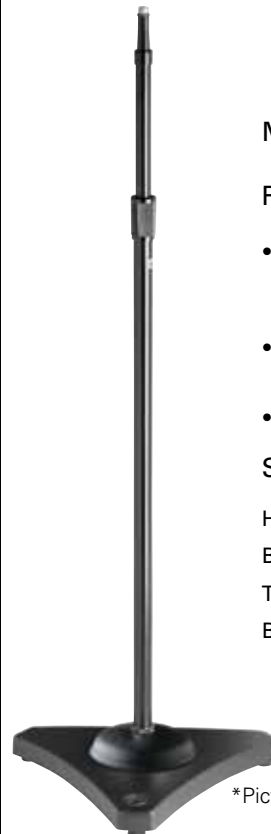

MS25E

Features

- Receive Maximum Stability of Triangular and Oversized Bases with Edge- Concentrated Weight Distribution
- Wear-Resistant, Three-Piece Clutch Offers Secure, Fast, and Noise-Free Height Adjustment
- Air Suspension System

Specifications

Height Span	38" - 67" (970-1700mm)
Base Size	15" tri. (380mm)
Tube Finish	Ebony
Base Finish	Ebony w/ Chrome Cover*

*Pictured with Cover Removed



Innovative design allows for convenient storing while still delivering renowned Atlas construction and durability.

Stackable Mic Stands

Applications

The SMS5B is designed to be convenient to store and quick to set up. The unique base design allows up to six stands to be stacked on top of each other in a single 10" footprint. These high quality stands are ideal for use in schools, houses of worship, or any multi-use facility where microphone stands are needed.

Features

- 2 Section Design
- Wear-Resistant Clutch
- Stackable Design
- Must Purchase in Masterpack Quantities of 6

General Description

The SMS5B saves stage and storage space with its ability to stack as many as six units in a single 10" footprint. Now a single layer of microphone stands doesn't need to take up a separate storage room, and space on stage is freed up because of the compact base design. Unit features a wide mouth opening and floating pole design that, through slight rotation, can be easily stacked. The 5/8" and 7/8" diameter tubing is fully adjustable with a vertical extension ranging from 33" to 60-1/2" heights. The SMS5B is available in non-reflective ebony.

Specifications

Height Span	33" - 60-1/2" (840-1540mm)
Base Size	10" dia. (250mm)
Tube Finish	Ebony
Base Finish	Ebony





The Platinum Design Series features solid construction using molded or cast parts rather than plastic parts like those found on other tripod stands. The PDS offers the versatility of a tripod stand with the reliability and durability found in other Atlas stands. Quality is never compromised.

Platinum Design Series

Applications

The Atlas Sound Platinum Design Series tripods and booms are ideal for any application including live stage/touring, house of worship, recording studios, and broadcast scenarios.

Features

- Low Profile Leg Cup For Increased Stability
- Heavy Duty Clutch Assembly
- Boom Swivel Including Friction Notches That Prevent Sagging
- Cast ½ lb Counterweight
- Non-Reflective Ebony Finish
- Available as Separate Parts or Complete Kits

General Description

Platinum design tripod/boom systems are engineered to provide the highest level of performance and quality for high demanding applications with the positioning convenience and compact storage advantage only a tripod stand can provide. Night after night on stage or session after session in the studio, performances will never be compromised by a mic stand failure when you use the Platinum Design Series tripod mic stands & booms.

T3664 - Versatile stand that is adjustable from 36" to 64" to meet the needs of seated and standing instrumentalists and performers. Model includes two section metal tubing with 3 piece clutch for easy vertical height adjustment. Unit also features three, low profile metal legs with cup terminations for optimum stability and balance. The end is threaded 5/8" - 27 and includes a lock-nut ring for versatile positioning of accessories or extension boom. The T3664 has a base spread of 25" (653mm) inches and weighs 5 lbs without boom and 7 lbs with boom.

T1930 - Versatile stand that is adjustable from 19" to 30" to meet the needs of seated instrumentalists and performers. Model includes two section metal tubing with 3 piece clutch for easy vertical height adjustment. Unit also features three, low profile metal legs with cup terminations for optimum stability and balance. The end is threaded 5/8" - 27 and includes a lock-nut ring for versatile positioning of accessories or extension boom. The T1930 has a base spread of 25" (653mm) inches and weighs 4 lbs without boom and 6 lbs with boom.

B2237 - Adjustable boom designed to be used with the T3664 or T1930 vertical mic stands. Friction notches on the boom swivel are designed to prevent sagging even when used with heavy microphones. Cast 0.5 lb counterweight allows for proper boom positioning while maintaining boom arm balance. B2237 is adjustable from 22" to 37".

TB3664 - Kit includes (1)T3664 & (1)B2237 Combination - Ebony

TB1930 - Kit includes (1)T1930 & (1)B2237 Combination - Ebony

MSB3 - Carrying bag* for up to (3) Platinum Design Series Stands

MSB6 - Carrying bag* for up to (6) Platinum Design Series Stands

* Carrying bag not pictured.





T3664

Features

- All Purpose Tripod Mic Stand
- Heavy Duty Clutch Assembly
- Low Profile Leg Cup For Increased Stability

Specifications

Description	Tall Tri-Pod Base
Height Span	36" - 64" (910-1630mm)
Base Size	25" (64 cm)
Tube Finish	Non-Reflective Ebony



T1930

Features

- All Purpose Tripod Mic Stand
- Heavy Duty Clutch Assembly
- Low Profile Leg Cup For Increased Stability

Specifications

Description	Short Tri-Pod Base
Height Span	19" - 30" (480-760mm)
Base Size	25" (640mm)
Tube Finish	Non-Reflective Ebony



B2237

Features

- Boom Swivel Including Friction Notches That Prevent Sagging
- Cast 0.5lb Counterweight

Specifications

Description	Telescoping Boom
Height Span	22" - 37" (560-940mm)
Tube Finish	Non-Reflective Ebony



Atlas Sound studio boom stands deliver the performance and consistency that professional musicians and producers demand from their equipment.



Atlas Studio Boom Mics can be Used for Vocal and Instrument Recording

Studio Boom Stands

Applications

This Atlas Sound professional quality boom stand incorporates the functional features and service reliability desired by performers and musicians, as well as broadcast/recording studios, theaters, and performance centers. All models are designed to meet the varying operational requirements of daily recording applications by combining maximum height and boom articulation ranges with increased mobility and dependable performance.

Features

- Professional Boom Stand for Stage and Studio Use
- Caster-Equipped Model Offers Silent and Effortless Mobility
- Adjustable 6 or 2 lb Counterweight Provides Precision and Stability
- Wear-Resistant, Three-Piece Clutch Offers Secure, Fast, and Noise Free Adjustment
- Variable, Piston-Type Air Suspension System Ensures Microphone Protection
- Rugged Construction and Heavy-Duty Components Assure Long Service Life

General Description

SB36W/SB36WE

These top-of-the-line boom stands feature a variable, piston-type air suspension system to ensure microphone protection. Model SB-36W is equipped with silent-motion, ball-bearing swivel casters of hard rubber for friction-free and vibration-absorbing mobility.

Two-piece horizontal boom assembly is $\frac{7}{8}$ " diameter cold rolled steel with a heavy-duty, die-cast, gyromatic swivel and an adjustable 6-lb. counterweight for precise and secure orientation. Tubing terminates with an adjustable mic holder swivel with standard $\frac{5}{8}$ "-27 thread to accept all microphones, holders, and adapters.

Vertical tube assembly is manufactured of 1- $\frac{1}{8}$ " and $\frac{7}{8}$ " chrome-plated cold rolled steel and includes the wear-resistant Atlas Sound grip-action clutch for easy adjustment and positive locking. Model includes wheels for a height span of 49" to 73". Triangular cast metal base with edge-concentrated weight distribution offers extra stability and is finished in ebony epoxy with a chrome shell.

SB-11WE

Economical studio boom is especially suited for small studio/broadcast applications and for stage miking of drums and percussion instruments. Unit features a 60" long, two-piece horizontal boom assembly constructed of steel tubing. Boom includes a Performer Series swivel clamp and an adjustable 2 lb counterweight for effortless boom arm orientation. Tubing also incorporates a 90° angled end for optimum microphone positioning and terminates in the standard $\frac{5}{8}$ "-27 thread to accept all microphones, holders, and adapters.

Vertical tube assembly is 1- $\frac{1}{8}$ " and $\frac{7}{8}$ " diameter cold rolled steel with an adjustable height span of 43" to 68". Tubing features the wear-resistant Atlas Sound grip action clutch for positive locking control. Triangular die-cast base with edge concentrated weight distribution offers extra stability and is equipped with three, hard rubber swivel casters for effortless and silent mobility. Entire assembly is finished in non-reflective ebony epoxy.





SB36WE

Specifications

Tube Style	Two Section
Height Span	49" - 73" (1250-1850mm)
Boom Length	62" (1580mm)
Counterweight	Adjustable. 6 lbs (2.75 kg)
Base Size	21" (530mm)*
Stability Factor	1890 I.S.I.**
Weight	40 lbs (18 kg)
Base Finish	Ebony
Tube Finish	Ebony



SB36W

Specifications

Tube Style	Two Section
Height Span	49" - 73" (1250-1850mm)
Boom Length	62" (1580mm)
Counterweight	Adjustable 6 lbs (2.75 kg)
Base Size	21" (530mm)*
Stability Factor	1890 I.S.I.**
Weight	40 lbs (18 kg)
Base Finish	Ebony with Chrome Shell
Tube Finish	Chrome



SB11WE

Specifications

Tube Style	Two Section
Height Span	43" - 68" (1090-1730mm)
Boom Length	60" (1520mm)
Counterweight	Adjustable 2 lbs (0.9 kg)
Base Size	21" (530mm)*
Stability Factor	1610 I.S.I.**
Weight	26 lbs (11.8 kg)
Base Finish	Ebony
Tube Finish	Ebony

* Dimension includes wheels. Triangular cast base is 15"

** Stability Index Factor (I.S.I.) evaluates the ability of a stand/boom assembly to remain at rest when acted upon by an outside force.



Atlas Sound drum miking stands are known for their reliability and durability whether they are used in studio or on stage.



Drum Miking Stands

Applications

Atlas DM Series mic stands are designed to offer excellent performance and durability similar to that found on the MS Series. These stands can be deployed on stage or in studio and can be relied on to stand up to the abuses of being on the road. DM stands feature the acclaimed Atlas wear-resistant clutch and look great on any stage with any drum kit.

Features

- Field Serviceable Parts Guarantee Long Product Life
- High-Quality Materials Withstand Frequent Transport, Set-Up, and Tear-Down
- Low-Height Adjustment is Ideal for Close-in Miking of Amplifiers, Percussion, String, and Rhythm Instruments
- Oversized Cast Base Provides Maximum Stability and Protection for High-Quality Kick-Drum Microphones
- Wear-Resistant, 3-Piece Clutch Offers Secure, Fast, and Noise-Free Height Adjustment
- Finished in Chrome or Ebony

General Description

Because of their extraordinary stability, these low-height, adjustable microphone stands are ideal for professional miking of drum kits, percussion and string instruments, and guitar/bass guitar amplifiers. Combine this low-to-medium height stand with companion boom Model PB11X(E) for use by seated performers on stage or in the studio. The combination of a floor-stand base with desk-stand height is ideal for kick-drum miking. Includes a threaded tip assembly for compatibility with a variety of booms, clamps, goosenecks, and accessories.



Atlas Offers a Drum Mic Stand for Every Type of Drummer and Kit



DMS7

Features

- High-Quality Materials Withstand Frequent Transport, Set-Up, and Tear-Down
- Low-Height Adjustment is Ideal for Close-in Miking of Amplifiers, Percussion, String, and Rhythm Instruments
- Oversized Cast Base Provides Maximum Stability and Protection for High-Quality Kick-Drum Microphones

Specifications

Height Span	8" - 13" (200 - 330mm)
Base Size	10" (25cm)
Base Finish	Ebony
Tube Finish	Chrome



DMS7E

Features

- High-Quality Materials Withstand Frequent Transport, Set-Up, and Tear-Down
- Low-Height Adjustment is Ideal for Close-in Miking of Amplifiers, Percussion, String, and Rhythm Instruments
- Oversized Cast Base Provides Maximum Stability and Protection for High-Quality Kick-Drum Microphones

Specifications

Height Span	8" - 13" (200 - 330mm)
Base Size	10" (25cm)
Base Finish	Ebony
Tube Finish	Ebony



DMS10

Features

- High-Quality Materials Withstand Frequent Transport, Set-Up, and Tear-Down
- Low-Height Adjustment is Ideal for Close-in Miking of Amplifiers, Percussion, String, and Rhythm Instruments
- Oversized Cast Base Provides Maximum Stability and Protection for High-Quality Kick-Drum Microphones

Specifications

Height Span	14¼" - 26¼" (360 - 670mm)
Base Size	10" (250mm)
Base Finish	Ebony
Tube Finish	Chrome

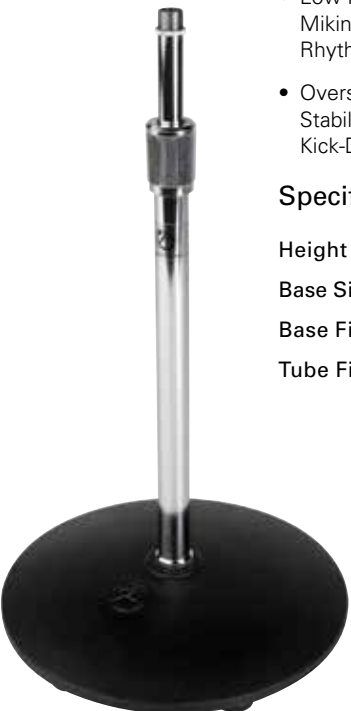

DMS10E

Features

- High-Quality Materials Withstand Frequent Transport, Set-Up, and Tear-Down
- Low-Height Adjustment is Ideal for Close-in Miking of Amplifiers, Percussion, String, and Rhythm Instruments
- Oversized Cast Base Provides Maximum Stability and Protection for High-Quality Kick-Drum Microphones

Specifications

Height Span	14¼" - 26¼" (360 - 670mm)
Base Size	10" (250mm)
Base Finish	Ebony
Tube Finish	Ebony





News anchors, sportscasters, and radio personalities trust Atlas Sound desktop mic stands to provide the support their equipment needs, night in and night out, year after year.

SMS2B

Specifications

Base Size	6" Diameter
Stand Height	5"
Weight	1.8 lbs (0.82 kg)
Base Material	Cast Iron
Base Finish	Ebony
Tube Finish	Ebony



Desktop Mic Stands

Applications

Atlas Sound microphone stands meet functional and aesthetic requirements for microphone support and placement within contemporary and traditional decors. The extensive selection includes models for use on banquet and meeting room consoles, court room and dispatcher desks, sports/recreation booths, church pulpits, and telephone switchboards. High-stability units are also suited for application in various sound reinforcement systems, as well as broadcast and recording studios.

Features

- Versatile Stands Fulfill Functional and Aesthetic Miking Requirements for Microphone Placement
- Quality Construction Assures Extended Service and Quality Appearance
- Weighted Bases Provide Maximum Stability

General Description

Atlas Sound microphone desk stands assure optimum stability and "like new" appearance for many years of service. Ebony finished bases are attractively styled and present a quality appearance for traditional and contemporary decors. Microphone placement and positioning is enhanced by the "locking nut" feature which securely fastens adapters and holders to the desk stands. The seamless tubing is 5/8" cold rolled steel and terminates in the industry standard 5/8" - 27 thread pattern for use with microphone accessories. Fixed-height stand selection includes Models DS2, DS5(E), and DS14. Adjustable-height stand Model DS7(E) features the wear-resistant 3-piece clutch for positive locking control.

DS2 - Low silhouette stand features an integral tension variable mount to reduce conductivity of external mechanical vibrations. High-stability, die-cast metal base with protective pads includes notched area for convenient placement of cards or pens. Fixed-height tubing is chrome plated. Base is supplied in non-reflective ebony.

DS14 - Professionally styled stand includes die-cast "wishbone" shaped base. Finished in ebony and features 3" high chrome tubing.

DS5/DS5E - Fixed-height stands include traditional, circular cast iron base and chrome-plated tubing for application with any standard microphone. DS5 features chrome plated tubing, DS5E is finished in ebony epoxy.

DS7/DS7E - Versatile stands may be adjusted from 8" - 13" and include a grip-action clutch and ebony-finished cast iron base. DS-7 features chrome-plated tubing; DS7E is supplied with non-reflective ebony tubing.

SMS2B - Saves desk and storage space with its ability to stack as many as six units in a single 6" footprint. Unit features a wide mouth opening and floating pole design that, through slight rotation, can be easily stacked. The SMS2B is available in non-reflective ebony.



Desktop Mic Stands Are Ideal for Use In Conference Panel Applications



DS2

Specifications

Base Size	6" L x 4" W
Stand Height	4"
Weight	2 lbs (1 kg)
Base Material	Cast Zinc
Base Finish	Ebony
Tube Finish	Chrome



DS14

Specifications

Base Size	Wishbone
Stand Height	8"
Weight	1 lb (0.45 kg)
Base Material	Cast Iron
Base Finish	Ebony
Tube Finish	Chrome



DS5

Specifications

Base Size	6" Diameter
Stand Height	5"
Weight	3 lbs (1.4 kg)
Base Material	Cast Iron
Base Finish	Ebony
Tube Finish	Chrome



DS5E

Specifications

Base Size	6" Diameter
Stand Height	5"
Weight	3 lbs (1.4 kg)
Base Material	Cast Iron
Base Finish	Ebony
Tube Finish	Ebony



DS7

Specifications

Base Size	6" Diameter
Stand Height	8" - 13"
Weight	3 lbs (1.4 kg)
Base Material	Cast Iron
Base Finish	Ebony
Tube Finish	Chrome



DS7E

Specifications

Base Size	6" Diameter
Stand Height	8" - 13"
Weight	3 lbs (1.4 kg)
Base Material	Cast Iron
Base Finish	Ebony
Tube Finish	Ebony





Atlas Sound booms are regarded as the best in the industry and with a wide selection available, there is an Atlas Solution for any boom need.

Boom Attachments

Applications

Atlas Sound boom attachments are designed to work in conjunction with Atlas Sound mic stands for studio, recording, and performance applications.

Features

- Chrome or Ebony Finish
- Perfect for Drum/Piano/Guitar Amp and Short Distance Miking
- Threaded End Cap and a Fixed 2 lb. Counterweight for Stability
- Adjustable 1½ lb. Counterweight For Stability
- Fixed Length Boom for General Recording and Live Sound Applications
- Booms Extend With a Single Motion and Are Suitable for a Wide Variety of Miking Applications

General Description

The PB11XCH / PB11XEB are compact booms that extend from 16¼" to 24½" with a single motion, perfect for drum/piano/guitar amp and short distance miking. Units include a threaded end cap and an adjustable 1½ lb counterweight for stability. Finish is chrome or ebony epoxy.

The PB15CH / PB15EB are fixed length, all-purpose, high-quality booms that measure 34" long and include an adjustable 1½ lb counterweights for stability. Finish is chrome or ebony epoxy.

The PB21XCH / PB21XEB booms extend from 25¼" to 38½" with a single motion and are suitable for a wide variety of miking applications. Units include a threaded end cap and an adjustable 1½ lb counterweight for stability. Finish is chrome or ebony epoxy.



Atlas Boom Attachments Are Ideal for Stage or Studio





PB11XCH

Specifications

Height Span	16¼" - 24½" (410 - 622mm)
Counter Weight	Adjustable 1½ lb
Tube Finish	Chrome Plated



PB11XEB

Specifications

Height Span	16¼" - 24½" (410 - 622mm)
Counter Weight	Adjustable 1½ lb
Tube Finish	Ebony Epoxy



PB15CH

Specifications

Height	34" (860mm)
Counter Weight	Adjustable 1½ lb
Tube Finish	Chrome Plated



PB15EB

Specifications

Height	34" (860mm)
Counter Weight	Adjustable 1½ lb
Tube Finish	Ebony Epoxy



PB21XCH

Specifications

Height Span	25¼" - 38½" (640 - 980mm)
Counter Weight	Adjustable 1½ lb
Tube Finish	Chrome Plated



PB21XEB

Specifications

Height Span	25¼" - 38½" (640 - 980mm)
Counter Weight	Adjustable 1½ lb
Tube Finish	Ebony Epoxy



Portable, durable, and lightweight are the hallmarks of a quality speaker stand that is never in the same spot twice. High quality materials and design make these the only option for professionals and enthusiasts alike.



SS500E
*Shown with
SM12CXT Mounted Via
SSA7 Speaker Adapter
(SSA7 & SM12CXT
Sold Separately)*

SS500E Speaker Stand

Specifications

Base Type	46" (1150mm) Tripod
Height Span	55" - 83" (1400 - 2110mm)
Weight	6.3 lbs (2.86 kg)
Finish	Ebony

Boom Attachments

Applications

The Atlas SS500E is ideal for elevating sound, monitor, and control equipment for touring musicians as well as for use in churches, schools, theaters, and anywhere needing easy transport, set-up, and tear down. The lightweight stand provides easy vertical positioning at a variety of heights and folds for quick mobility and storage. The optional SSA7 platform adapter extends application versatility to speakers without stand pole mounting capability.

Features

- Supports up to 150lbs
- Stand Folds to a Minimal 55" for Convenient Portability
- Height Adjusts from 55" to 83" for Vertical Flexibility
- Positive Clamping System for Slip-Free Equipment Support

General Description

The SS500E was designed for easy transportability, set-up, and tear-down; the heavy-duty aluminum speaker stand SS500E weighs a mere 6.3lbs and supports up to 150lbs. Additionally, the stand folds to a minimum length of 55" making it a great portable stand for touring musicians and in churches, schools, and theaters. The height adjusts from 55" to 83" for versatile positioning and support of sound, monitor, and control equipment.

Stand is equipped with a positive clamping system with safety pin to assure slip-free support of elevated equipment. Reversible vertical tube assembly contains 1½" and 1¾" tubing ends. Clutch mechanism includes a protective insert for scratch-free height adjustment. The stand is finished in non-reflective ebony and the clutch mechanism includes a protective insert for scratch-free height adjustments.

The optional universal platform adapter SSA7 for the Atlas SS500E features two ¾" x 2" slots plus 12 equipment mounting holes to meet a variety of support applications. Mounting holes also match OmniMount™ 30 and 60 Series patterns. Material is steel and the finish is ebony.

SSA7 Speaker Adapter

Specifications

Base Type	Universal Platform
Mounting Pattern	Two ¾" - 2" Slots and Twelve Holes
Weight	1 lb (0.45 kg)
Finish	Ebony





Atlas Sound offers a wide assortment of microphone stand accessories that address the needs of all types of applications and performers to ensure that the job can get done properly on time, every time.

Microphone Clip

Features

- Made from Rugged Molded Plastic
- Accommodates Microphones with a Tapered Diameter of 1" - 1½"

General Description

This industry standard microphone clip is available in black.



MICCLIP

Specifications

Thread Connection	5/8"-27
Finish	Ebony

Quick Release Tube Adapter

Features

- Perfect For Touring Companies Who Require Quick Dis-Assembly For Storage and Transportation
- Works With 5/8"-27 Threaded Stands - MS-10C, MS-10CE, MS-12C, MS-12CE

General Description

The two piece design uses a unique ball bearing interconnect designed to save set-up and tear down time in touring applications. For installation the QR-2 assembly is threaded between the 7/8" tube and base of the mic stand (MS10C, MS10CE, MS12C, MS12CE). After the show, the technician simply steps on the low profile outer release ring of the QR-2 allowing the entire upper tube assembly to be separated from the base saving the time consuming operation of unscrewing the base/tube for storage.

The QR-2 is constructed of durable machined steel and finished in black chromate to blend in perfectly with the mic stand base top surface for an unobtrusive on-stage look.



QR-2

Specifications

Diameter	7/8" (22.2mm)
Weight	1.5 lbs (0.68 kg)

Gooseneck Flexible Extensions

Features

- Attach to Any Mic Stand or Adapter with $\frac{5}{8}$ "-27 Threads
- Available in Chrome or Ebony
- Flexible Enough to Adjust, Strong Enough to Stay In Place

General Description

Flexible goosenecks in 6", 13", and 19" lengths, respectively, attach to any microphone stand or adapter with $\frac{5}{8}$ "-27 male and female threads. Inside diameter is .338". Available in chrome or ebony (E) finish.



GN-6

Specifications

Length	6" (152.4 cm)
Diameter	$\frac{3}{8}$ " (09.5mm)
Weight	0.25 lbs (0.11 kg)
Finish	Chrome

GN-6E

Specifications

Length	6" (152.4 cm)
Diameter	$\frac{3}{8}$ " (09.5mm)
Weight	0.25 lbs (0.11 kg)
Finish	Ebony

GN-13

Specifications

Length	13" (330.2mm)
Diameter	$\frac{3}{8}$ " (09.5mm)
Weight	0.5 lbs (0.23 kg)
Finish	Chrome

GN-13E

Specifications

Length	13" (330.2mm)
Diameter	$\frac{3}{8}$ " (09.5mm)
Weight	0.5 lbs (0.23 kg)
Finish	Ebony

GN-19

Specifications

Length	19" (482.6mm)
Diameter	$\frac{3}{8}$ " (0.95 cm)
Weight	0.75 lbs (0.34 kg)
Finish	Chrome

GN-19E

Specifications

Length	19" (482.6mm)
Diameter	$\frac{3}{8}$ " (0.95 cm)
Weight	0.75 lbs (0.34 kg)
Finish	Ebony

Clip Mounting Accessories

Features

- Largest Selection of Microphone Adapters, Extensions, Fittings, and Flanges for use with Floor, Desk, Loudspeaker, and Studio Boom Stands
- U. S. Standard 5/8"-27 Termination Accommodates All Types of Microphone Holders and Stands
- Quality Craftsmanship Assures Compatibility and Long-Lasting Performance
- Durable Design for use in Touring P.A. Applications

General Description

LO-2B/LO-2BE - Lock-on accessory provides for fast, convenient set-up and take-down of microphone holders and boom attachments with standard 5/8"-27 threads. Accessory is particularly useful for outdoor touring applications where inclement weather can necessitate the quick removal of expensive microphones. Unit features a secure, snap-on fastener and durable, push-button release. 2 5/8" long. Available in chrome or ebony (E).

LO-2F - 100 piece bulk pack of LO-2B disconnect top section only. Chrome finish.

LO-2FE - 100 piece bulk pack of LO-2BE disconnect top section only. Ebony finish.

TM-1/TM-1E - Twin microphone mounts provide for the horizontal attachment of two or three 5/8"-27 threaded microphones onto most stands, goosenecks and stand adapters. Units are 8 3/4" wide and finished in chrome or ebony (E).

LO-2B

Specifications

Weight	0.19 lbs (0.09 kg)
Finish	Chrome

LO-2BE

Specifications

Weight	0.19 lbs (0.09 kg)
Finish	Ebony

TM-1

Specifications

Weight	0.31 lbs (0.14 kg)
Finish	Chrome

TM-1E

Specifications

Weight	0.31 lbs (0.14 kg)
Finish	Ebony



Multi-Purpose Clamps

Features

- Largest Selection of Microphone Adapters, Extensions, Fittings, and Flanges for use with Floor, Desk, Loudspeaker, and Studio Boom Stands
- U. S. Standard $\frac{5}{8}$ "-27 Termination Accommodates All Types of Microphone Holders and Stands
- Quality Craftsmanship Assures Compatibility and Long-Lasting Performance
- Durable Design for use in Touring P.A. Applications

General Description

CO-1B - Connect-on swivel adapter/clamp facilitates installation of a second microphone with standard $\frac{5}{8}$ "-27 threads to any floor or desk stand with $\frac{5}{8}$ " or $\frac{7}{8}$ " dia. tubing. Adapter piece can be removed and fastened to mic mount for fast, easy set-up and take-down. $3\frac{1}{2}$ " long. Ebony finish.

MAC-1 - Patented, multi-use adapter/clamp secures microphones, horizontal booms, or accessories with standard $\frac{5}{8}$ "-27 threads. Versatile unit also clamp mounts to $\frac{5}{8}$ " and $\frac{7}{8}$ " diameter tubing or to free-standing instruments, keyboards, synthesizers, drum, and percussion instruments with tubing/mounting surface up to $1\frac{1}{2}$ " in diameter. Unit is equipped with uniquely-engineered three-position, removable hex adapter which allows for convenient vertical or horizontal mounting. Clamp features nylon end cap to prevent marring of tube/surface finish. Fabricated from high-strength extruded aluminum and finished in ebony epoxy. $3\frac{1}{2}$ " high.



MAC-1

Specifications

Length	$3\frac{1}{2}$ " (88.9mm)
Weight	0.38 lbs (0.17 kg)
Finish	Ebony Epoxy



CO-1B

Specifications

Length	$3\frac{1}{2}$ " (88.9mm)
Weight	0.19 lbs (0.09 kg)
Finish	Ebony

Cable Hangers and Feed-Thru Adapter

Features

- Largest Selection of Microphone Adapters, Extensions, Fittings, and Flanges for use with Floor, Desk, Loudspeaker, and Studio Boom Stands
- U. S. Standard $\frac{5}{8}$ "-27 Termination Accommodates All Types of Microphone Holders and Stands
- Quality Craftsmanship Assures Compatibility and Long-Lasting Performance
- Durable Design for use in Touring P.A. Applications

General Description

AD-15B - Chrome $4\frac{1}{2}$ " cable feed-thru adapter with standard $\frac{5}{8}$ " male and female threads.

CH-1B/CH-1BE - Versatile and unique accessory can be used to conveniently hang a tambourine or to neatly guide cabling down the tube. Single screw-mounting clamp adjusts to fit all tube assembly sizes. Available in chrome or ebony (E).



CH-1B

Specifications

Weight	0.31 lbs (0.14 kg)
Finish	Chrome



CH-1BE

Specifications

Weight	0.31 lbs (0.14 kg)
Finish	Ebony



AD-15B

Specifications

Weight	0.14 lbs (0.06 kg)
Finish	Chrome

Tube Extensions

Features

- Durable Design for use in Touring P.A. Applications
- Quality Craftsmanship Assures Compatibility and Long-Lasting Performance
- U.S. Standard $\frac{5}{8}$ "-27 Termination Accommodates All Types of Microphone Holders

General Description

AD-4B - Tube extension coupling, $\frac{3}{4}$ " long with $\frac{5}{8}$ "-27 male running thread. Brass finish, no plating.

AD-5B - Tube extension coupling, $\frac{5}{8}$ "-27 female to $\frac{5}{8}$ "-27 female. Chrome plated.

AD-6B - Tube extension coupling, $\frac{7}{8}$ " female to $\frac{7}{8}$ "-27 female. Chrome plated.

AD-7B - Tube extension, 3" long with $\frac{5}{8}$ "-27 male threads at each end. Chrome plated.

AD-8B - Tube extension, 6" long with $\frac{5}{8}$ "-27 male threads at each end. Chrome plated.



AD-4B



AD-5B



AD-6B



AD-7B



AD-8B

AD-4B

Specifications

Length	$\frac{3}{4}$ " (19.1mm)
Diameter	$\frac{5}{8}$ " (15.9mm)
Weight	0.0375 lbs (0.02 kg)
Finish	Brass

AD-5B

Specifications

Length	$\frac{3}{4}$ " (19.1mm)
Diameter	$\frac{5}{8}$ " (15.9mm)
Weight	0.0375 lbs (0.02 kg)
Finish	Chrome

AD-6B

Specifications

Length	$1\frac{1}{2}$ " (38.1mm)
Diameter	$\frac{7}{8}$ " (22.2mm)
Weight	0.125 lbs (0.06 kg)
Finish	Chrome

AD-7B

Specifications

Length	3" (76.2mm)
Diameter	$\frac{5}{8}$ " (15.9mm)
Weight	0.08 lbs (0.04 kg)
Finish	Chrome

AD-8B

Specifications

Length	6" (152.4mm)
Diameter	$\frac{5}{8}$ " (15.9mm)
Weight	0.1375 lbs (0.06 kg)
Finish	Chrome

Surface Mount Mic Flange

Features

- Durable Design for use in Touring P.A. Applications
- Quality Craftsmanship Assures Compatibility and Long-Lasting Performance
- U.S. Standard 5/8"-27 Termination Accommodates All Types of Microphone Holders

General Description

AD-11B - Surface mount female mic flange, 5/8"-27 female thread with 1 1/4" base diameter. Chrome finish.

AD-11 - 100 piece bulk pack of AD-11B. Chrome finish.

AD-11BE - Surface mount female mic flange, 5/8"-27 female thread with 1 1/4" base diameter. Ebony finish.

AD-11E - 100 piece bulk pack of AD-11BE. Ebony finish.

AD-12B - Surface mount male mic flange, 5/8"-27 male thread with 1 1/4" base diameter. Chrome finish.

AD-12 - 100 piece bulk pack of AD-12B. Chrome finish.

AD-12BE - Surface mount male mic flange, 5/8"-27 male thread with 1 1/4" base diameter. Ebony finish.

AD-12E - 100 piece bulk pack of AD-12BE. Ebony finish.



AD-11B



AD-11BE

AD-11B

Specifications

Diameter	1 1/4" (44.5mm)
Weight	0.0625 lbs (0.03 kg)
Finish	Chrome

AD-11BE

Specifications

Diameter	1 1/4" (44.5mm)
Weight	0.0625 lbs (0.03 kg)
Finish	Ebony

AD-12B

Specifications

Diameter	1 1/4" (31.75mm)
Weight	0.08 lbs (0.04 kg)
Finish	Chrome

AD-12BE

Specifications

Diameter	1 1/4" (31.75mm)
Weight	0.08 lbs (0.04 kg)
Finish	Ebony



AD-12B



AD-12BE

Replacement Parts - Floor Stands

Features

- Available in Choice of Chrome or Non-Reflective Ebony Epoxy Finish
- Economical, Industry Standard Floor Stands Suitable for a Variety of Applications
- Edge-Concentrated, One-Piece Circular Base Ensures Maximum Stability
- Field Serviceable Parts Guarantee Long Product Life
- Wear-Resistant, Three-Piece Clutch Offers Secure, Fast, and Noise-Free Height Adjustment

General Description

MSC-K - Service clutch kit for MS-10C / MS-12C / DMS7 / DS7. Includes Chrome finish barrel, split ring, and solid retainer ring.

MSCE-K - Service clutch kit for MS-10CE / MS-12CE / DMS7E / DS7E. Includes ebony finish barrel, split ring, and solid retainer ring.

MSC - Tube assembly for MS-10C / MS-12C. Includes one (1) 5/8" tube, one (1) 7/8" tube, and one (1) set of MSC-K components. Chrome finish.

MSCE - Tube assembly for MS-10CE / MS-12CE. Includes one (1) 5/8" tube, one (1) 7/8" tube, and one (1) set of MSCE-K components. Ebony finish.

MSC-K

Specifications

Diameter	7/8" (22.2mm)
Weight	0.30 lbs (0.14 kg)
Finish	Chrome

MSCE-K

Specifications

Diameter	7/8" (22.2mm)
Weight	0.30 lbs (0.14 kg)
Finish	Ebony

MSC

Specifications

Length	13" (330.2mm)
Weight	2.30 lbs (1.04 kg)
Finish	Chrome

MSCE

Specifications

Length	13" (330.2mm)
Weight	2.30 lbs (1.04 kg)
Finish	Ebony



Replacement Parts - Floor Stands

Features

- Available in Choice of Chrome or Ebony Finish
- Includes Air Dampening System
- Suitable for Indoor/Outdoor Use

General Description

MS2025T - Replacement tube assembly for MS20 / MS25. Chrome finish.

MS2025TE - Replacement tube assembly for MS20 / MS25. Ebony finish.

MS-20B - Base assembly for MS-20 / MS-20E. Ebony finish.

MS20-K - MS-20 / MS-25 / SB36W Clutch assembly. Chrome finish. Includes Chrome clutch barrel, compression split ring, and metal insert.

MS20E-K - MS-20E / MS-25E / SB11WE / SB36WE Clutch assembly. Ebony finish. Includes Ebony clutch barrel, compression split ring, and metal insert.

MS2XTA - MS-20 / MS-25 Top adapter. Chrome finish. Converts $\frac{7}{8}$ " - 27 tube (male) to $\frac{5}{8}$ " - 27 tube (male).

MS2XTAE - MS-20 / MS-25 Top adapter. Ebony finish. Converts $\frac{7}{8}$ " - 27 tube (male) to $\frac{5}{8}$ " - 27 tube (male).



MS20-K



MS2XTA



MS2XTAE

MS2025T

Specifications

Diameter	1 $\frac{1}{8}$ " (28.6mm)
Height	62 $\frac{1}{2}$ " (158.75mm)
Finish	Chrome

MS2025TE

Specifications

Diameter	1 $\frac{1}{8}$ " (28.6mm)
Height	62 $\frac{1}{2}$ " (158.75mm)
Finish	Ebony

MS-20 B

Specifications

Diameter	12" (304.8mm)
Weight	20 lbs (9.1 kg)
Finish	Ebony

MS20-K

Specifications

Diameter	1 $\frac{1}{8}$ " (28.6mm)
Weight	.50 lbs (.23 kg)
Finish	Chrome

MS20E-K

Specifications

Diameter	1 $\frac{1}{8}$ " (28.6mm)
Weight	.50 lbs (.23 kg)
Finish	Ebony

MS2XTA

Specifications

Diameter	$\frac{7}{8}$ " (22.2mm)
Weight	.25 lbs (.11 kg)
Finish	Chrome

MS2XTAE

Specifications

Diameter	$\frac{7}{8}$ " (22.2mm)
Weight	.25 lbs (.11 kg)
Finish	Ebony

Replacement Parts - Studio Booms

General Description

PBB-K - Replacement swivel assembly for model SB-36W stands manufactured prior to 2003.

SB36CSTR - Caster Kit For SB-11-WE and SB-36W Mic Stands.

SB36WGHT - Replacement 6 lb. counterweight for the SB-36 and SB-36W Studio Boom. Ebony Finish.

XX4707700 - Replacement swivel guide for SB-36 and SB-36W mic stands. Swivel fits 7/8" - 27 tube size. Chrome finish.



PBB-K

Specifications

Weight	2.15 lbs (0.98 kg)
Finish	Ebony

SB36CSTR

Specifications

Weight	3.3 lbs (1.5 kg)
Finish	Chrome and Black

SB36WGHT

Specifications

Weight	6 lbs (2.72 kg)
Finish	Ebony

XX4707700

Specifications

Weight	1.8 lbs (0.82 kg)
Finish	Chrome

General Service Parts

General Description

LR58E-25 - 7/8" - 27 lock ring for Atlas mic stands. Ebony finish, 25 pieces.

LR58E-25 - 7/8" - 27 lock ring for Atlas mic stands. Chrome finish, 25 pieces.

LR78E-10 - 7/8" - 27 lock ring for Atlas mic stands. Ebony finish, 10 pieces.

LR78C-10 - 7/8" - 27 lock ring for Atlas mic stands. Chrome finish, 10 pieces.

MS1012RF-24 - Replacement feet for MS10 and MS12 stands manufactured prior to 2003. 24 pieces.

MS12BASE - Base assembly for MS-12C / MS-12CE. Ebony finish.



LR58E-25

LR58C-25

Specifications

Weight	0.18 lbs (0.08 kg)
Finish	Chrome



MS1012RF-24

LR78C-10

Specifications

Weight	0.22 lbs (0.1 kg)
Finish	Chrome

MS12BASE

Specifications

Weight	7 lbs (3.2 kg)
Finish	Ebony

MS1012RF-24

Specifications

Weight	0.52 lbs (0.24 kg)
Finish	Ebony

LR58E-25

Specifications

Weight	0.18 lbs (0.08 kg)
Finish	Ebony

LR78E-10

Specifications

Weight	0.22 lbs (0.1 kg)
Finish	Ebony

121-18.....	61	51-8.....	214	AD-4B.....	329	APF-15.....	182
124-18.....	61	510-4.....	225	AD-5B.....	329	APF-15T.....	182
12CX.....	139	535-25.....	53	AD-6B.....	329	APF-15TU.....	182
12CXT60.....	139	540-25.....	53	AD-7B.....	329	APF-15TUC.....	182
135-18.....	61	544-25.....	53	AD-8B.....	329	APR-30AT.....	181
140-18.....	62	544-30.....	53	ADZ502W.....	197	APT-34AT.....	182
144-18.....	62	60-8.....	214	ADZ612C.....	197	APX40TN.....	181
161-4.....	217	60-8W.....	215	AF140.....	161	AS-120-592.....	87
161-8.....	217	607-15.....	75	AH42-212-BSG.....	170	AS100N.....	207
164-12A.....	218	61-12W.....	215	AH54-15-BSG.....	169	AS140-592.....	87
164-12A-052.....	218	61-8W.....	215	AH66-12ST-BSG.....	168	AS2A-1M.....	304
164-15A.....	219	62-8.....	216	AH66-15-BSG.....	169	AS2A-2M.....	304
164-8A.....	217	735-25.....	50	AH66-212-BSG.....	170	AS2C-1M.....	303
164-8A-052.....	218	740-25.....	50	AH66-8ST-BSG.....	167	AS2C-2M.....	303
169-8.....	219	744-25.....	50	AH94-12ST-BSG.....	168	AS2C-3M.....	303
170-8A.....	219	744-30.....	51	AH94-15-BSG.....	169	AS2HDMI-15M.....	303
191-78.....	230	744-36.....	51	AH94-212-BSG.....	170	AS2HDMI-1M.....	303
191-78-8.....	230	830-812A.....	220	AH94-8ST-BSG.....	167	AS2HDMI-2M.....	303
193-8.....	189, 230	830-89A.....	220	AH99-12ST-BSG.....	168	AS2HDMI-3M.....	303
193-8-6.....	189, 231	840-812A.....	221	AH99-8ST-BSG.....	167	AS2HDMI-9M.....	303
194-812.....	231	840-89A.....	220	AHSUB15-BSG.....	171	AS2HDMMA-15M.....	303
194-89.....	231	8CXT60.....	139	AHSUBSTAND.....	171	AS2HDMMA-2M.....	303
195-815.....	232	912-18.....	76	AL-CM.....	299	AS2HDMMA-9M.....	303
195-89.....	232	916-18.....	76	AL-HSM.....	299	AS2PHX-1M-XLR.....	305
198-4.....	232	95-12.....	228	AL-IRDS.....	299	AS2RCA-1M-PHX.....	304
198-8.....	233	95-8.....	227	AL-LM.....	299	AS2RCA-2M-PHX.....	304
198-8-8.....	233	95-8-10.....	227	AL-MAGPIE.....	297	AS2RCA-3M-PHX.....	304
221-18.....	55	95-8-7.....	227	AL-MAGPIE-LANYARD.....	299	AS2XLR-10M.....	304
221-25.....	55	96-4.....	228	AL-MAGPIE-NEST.....	298	AS2XLR-15M.....	304
221-30.....	55	96-4X.....	228	AL-MYNA.....	297	AS2XLR-3M.....	304
224-18.....	56	96-8.....	229	AL-MYNA-LANYARD.....	299	ASP-MG24.....	270
224-25.....	56	96-8-10.....	229	AL-MYNA-NEST.....	298	ASP-MG24TDB.....	270
224-30.....	56	96-8-7.....	229	AL123A.....	191	ASUMRM9.....	86
235-18.....	57	AA-ML.....	21	AL2430.....	296	AT10.....	209
235-24.....	57	AA-PPRC.....	44	All Weather.....	197	AT10-PA.....	210
235-30.....	57	AA-SMG.....	21	AM1200.....	271	AT10-PARM.....	210
240-18.....	58	AA-TG.....	21	AP-15.....	180	AT10-RM.....	211
240-24.....	58	AA-YSUM.....	305	AP-15T.....	180	AT100.....	209
240-30.....	58	AA120.....	19	AP-15TC.....	180	AT100-PA.....	210
244-18.....	59	AA120M.....	20	AP-15TU.....	180	AT100-PARM.....	210
244-24.....	59	AA240.....	19	AP-15TUC.....	180	AT100-RM.....	211
244-30.....	59	AA35.....	18	AP-15TUCR.....	180	AT100D.....	209
307-12.....	67	AA60.....	18	AP-2410-15S.....	107	AT10D.....	209
310-12.....	67	AAIT-600.....	44	AP-2410-20S.....	107	AT35.....	209
310-15.....	67	AARMK2-0.....	45	AP-30.....	181	AT35-PA.....	210
312-12.....	67	AARMK2-5.....	45	AP-30T.....	181	AT35-PARM.....	210
312-15.....	68	AAVC-10K.....	45	AP-30TC.....	181	AT35-RM.....	211
316-12.....	67	AAVCC-5.....	45	AP-7230-20S.....	109	AT35D.....	209
316-15.....	68	ACS-1.....	110	AP-C15D.....	93	ATPLATE-052.....	211
324-12.....	67	ACS-2A.....	110	AP-GNL18.....	99	AWR2-HR.....	79
324-15.....	68	AD-11.....	330	AP-S15.....	94	AWR2W.....	77
335-15.....	68	AD-11B.....	330	AP-S15L.....	94	AWR3-HR.....	79
407-15.....	73	AD-11BE.....	330	AP-S20.....	95	AWR3W.....	77
410-15.....	73	AD-11E.....	330	AP-S20RT.....	95	AWV2.....	87
410-4.....	225	AD-12.....	330	AP4840-15S.....	108	AWV3.....	87
412-15.....	73	AD-12B.....	330	AP4840-20S.....	108	AWV4.....	87
414-15.....	74	AD-12BE.....	330	AP7230-15S.....	109	B161-4.....	149
418-15.....	74	AD-12E.....	330	APBK.....	188	B2237.....	315
51-4.....	214	AD-15B.....	328	APC-30T.....	181	B51-4.....	148

BB-1616.....	7	CD94.....	174	ECM-20SH.....	103	FA6260T-8MB.....	131
BB-1616DT.....	8	CFT-125.....	91	ECM-30.....	102	FA62T-8MB.....	130
BB-168.....	7	CH-1B.....	328	ECM-3BP.....	102	FA720-4.....	125
BB-168AECDT.....	9	CH-1BE.....	328	ECM-ACIN.....	102	FA720-6.....	127
BB-168DT.....	7	CJ-46.....	175	ECM-RACEWY1.....	102	FA720-8.....	128
BB-816.....	7	CO-1B.....	328	ECM-RACEWY3.....	102	FA730-4.....	125
BB-816DT.....	7	CONTROLKOM.....	277	ECM-RACEWY6.....	102	FA730-6.....	127
BB-88.....	7	CP400.....	25	ECS-3.....	99	FA730-8.....	128
BB-88DT.....	7	CP700.....	25	ECS-6RM.....	97	FA95-4.....	125
BB-EB1616DT.....	11	CP700RMK.....	44	ECS-KSW3M.....	104	FA95-4NK.....	125
BB-SM1.....	10	CS95-8.....	235	ECS-KSW6.....	104	FA95-6.....	127
BBG13.....	83	CT1020-962.....	82	EFP3-1.....	81	FA95-6NK.....	127
BBG21.....	83	CT2525LCR.....	197	EFP3-1-HR.....	79	FA95-8.....	128
BBG24.....	83	CT520C.....	197	EFP3-2.....	81	FA95-8NK.....	128
BBG35.....	83	CT620C.....	197	EFT-25.....	81	FA97-4.....	125
BBG40.....	83	CT620W.....	197	EFT-30.....	81	FA97-4NK.....	125
BBG44.....	83	CT625C.....	197	EFT-36.....	81	FA97-6.....	127
BBWP-K1B.....	14	CT625W.....	197	EFT6-4.....	81	FA97-6NK.....	127
BBWP-K4B.....	16	CT800SW.....	197	EJ2003.....	193	FA97-8.....	128
BBWP-S4B.....	16	CT825C.....	197	EJW115A.....	193	FA97-8NK.....	128
BBWP-S4K1B.....	15	CT825W.....	197	EJW115X.....	193	FAM44-25SA.....	47
BBWP-S8B.....	15	CTD1-16.....	85	EL1503.....	192	FAMT-6.....	188
BBWP-TOUCH7B.....	14	D161-8.....	148	ELI2K.....	192	FAP40T.....	116
BIA-100.....	175	DLS4.....	145	ELIJAH2K.....	193	FAP40T-B.....	116
BMT95-4-7.....	234	DMS10.....	319	ELW110A.....	192	FAP42T.....	117
BMT95-6.....	234	DMS10E.....	319	ELW110X.....	192	FAP42T-B.....	117
BMT95-8-7.....	234	DMS7.....	319	EM410A.....	194	FAP42T-UL2043.....	118
BMT96-4.....	233	DMS7E.....	319	EM806A.....	194	FAP42TC.....	118
BT720-4.....	149	DNA7814DH.....	40	EMMA2K.....	194	FAP42TC-UL2043.....	119
BT720-4-T47.....	149	DNA7874DL.....	39	EQM131.....	272	FAP6260T.....	120
BX-1A.....	188	DNA7874H.....	38	EZ195-8.....	237	FAP62T.....	119
BX-2A.....	188	DNA7874L.....	37	EZ410.....	238	FAP62T-UL2043.....	120
BX-3A.....	188	DPA102PM.....	30	EZ95-8.....	236	FAP82T.....	121
C10A.....	136	DR-32.....	173	EZ96-4.....	236	FAP8CXT.....	121
C10AT25.....	136	DR-42.....	173	EZ96-4X.....	237	FAPR-4.....	125
C10AT70.....	137	DR-54.....	173	EZ96-8.....	237	FAPR-6.....	127
C10AT72.....	137	DR-72.....	173	EZB161-4.....	149	FAPR-8.....	128
C10AT72FRK.....	201	DS14.....	321	EZHD72W.....	145	FAPSUB-1.....	121
C12BT60.....	139	DS2.....	321	F-1.....	200	FB4CPB.....	307
C5AT25.....	136	DS5.....	321	F6-AMIX.....	35	FB4XLR.....	306
C5AT70.....	137	DS5E.....	321	F6-MF.....	33	FC104.....	133
C5AT72.....	137	DS7.....	321	FA-TR4.....	125	FC104T.....	133
C803A.....	134	DS7E.....	321	FA-TR6.....	127	FC104T72.....	133
C803AT167.....	135	DSP2210.....	269	FA-TR8.....	128	FC104T72FRK.....	201
C803AT47.....	134	DSP2212.....	269	FA134T87.....	125	FC136T87FRK.....	201
C803AT70.....	134	DSP8807.....	268	FA136.....	126	FC138T87FRK.....	201
C803AT72.....	135	DT12.....	122	FA136T47.....	126	FD25M222W.....	147
C803AT87.....	134	DT12-2X2ADP.....	123	FA136T87.....	127	FD25W.....	146
C803AT87FRK.....	201	DT6.....	123	FA138.....	128	FD70W.....	146
CB1.....	80	DUO.....	197	FA138T167.....	128	FD72M222W.....	147
CB1-HR.....	78	DUO-CP.....	197	FA138T327.....	128	FD72W.....	147
CB2.....	80	E408-100.....	211	FA138T87.....	128	FEST-I8S.....	246
CB2-HR.....	78	E410.....	235	FA170-4.....	125	FEST-I8SC.....	247
CB3.....	80	E410NK.....	235	FA170-6.....	127	FEST-IH.....	246
CB3-HR.....	78	E410NK-11.....	236	FA170-8.....	128	FM250-4.....	34
CB4.....	80	ECM-15SH.....	103	FA42T-6MB.....	130	FM250-70.....	34
CD4.....	84	ECM-20.....	101	FA51-4.....	125	FMA-44RR44.....	83
CD42.....	174	ECM-2063.....	98	FA51-6.....	127	FMA-RR35.....	83
CD64.....	174	ECM-20M.....	101	FA51-8.....	128	FMA35-25G.....	48

FMA35-25SA	47	IED1544BAS	43	MLE-3T	187	PD-30	178
FMA44-25G	48	IED1581NA-C	42	MMK-DB10	90	PD-30T	178
FMA44-36G	48	IED1581NA-D	41	MMK-IPM	90	PD-5VH	178
FMARTK25	82	IHVP	290	MMK-KVM8	90	PD-5VT	178
FMARTK36	82	IHVP-CK	282	MMK15-RM	89	PD-60A	177
G161-8	148	IP1	199	MMK17-RM	89	PD-60AT	177
GA-15T	184	IX1	199	MO-2	184	PD75T	177
GA-30T	184	IX2	199	MPP410-B	197	PM4FA-B	156
GD87	140	L20-100	189	MPP410-S	197	PM4FA-WH	156
GD87A	141	L20-101	189	MPP410-W	197	PM8CX-B	157
GD87W	141	L20-201	189	MPP4100-B	197	PM8CX-WH	157
GLOBALCOM	300	L20-213	189	MPP4100-S	197	PM8FA-B	156
GN-13	326	L20-220	189	MPP4100-W	197	PM8FA-WH	156
GN-13E	326	L20-222	189	MPP420-S	197	PM8GD-B	157
GN-19	326	LAR150	90	MPP420-W	197	PM8GD-WH	157
GN-19E	326	LBH-100	207	MPP4200-S	197	PM8SUB-B	157
GN-6	326	LL2	91	MPP4200-W	197	PM8SUB-WH	157
GN-6E	326	LO-2B	327	MPP520-S	197	PPR1	80
GSS-G	159	LO-2BE	327	MPP520-W	197	PPR1-HR	78
GST-G	159	LR4	91	MS-10C	311	PPR2	80
H620AW	197	LR58C-25	333	MS-10CE	311	PPR2-HR	78
H622AW	197	LR58E-25	333	MS-12C	311	PPR3	80
H625CE	197	LR78C-10	333	MS-12CE	311	PPR3-HR	78
H625WE	197	LR78E-10	333	MS-20B	332	PPR4	80
HD25W	146	LRS	91	MS1012RF	333	PPR5	80
HD70W	146	LT70	161	MS12BASE	333	PPR6	80
HD72W	147	LT72	161	MS20	312	PPR7	80
HK-40	87	M-1A	200	MS20-K	332	PSR-206	113
HK-40CN	87	M-1AJW	200	MS2025T	332	PSR-212	113
HLE-1	186	M-1CB4B	200	MS2025TE	332	Q408	238
HLE-1T	186	M100	274	MS20E	312	Q418	238
HLE-3	187	M1000-USA	274	MS20E-K	332	Q428-SA	239
HLE-3T	187	M1000-W	274	MS25	312	Q4412	239
HLE/MLE-30	185	M100R-W	275	MS25E	312	Q4612	239
HLE/MLE-32	185	M2000-LP	276	MS2XTA	332	Q4712	240
HPG-100N	207	M2000-SM	276	MS2XTAE	332	Q4812	240
HT-327	163	M222W	216	MSC	331	Q4915	240
HT167	163	M2525LCR	197	MSC-K	331	QR-2	325
HT42	162	M512C	197	MSCE	331	QS408	241
HT47	162	M512W	197	MSCE-K	331	RAC-5	110
HT87	162	M612C	197	MUSICAVC-50Z	197	RAC-5B	110
HXLP-3-11	307	M612W	197	MUSICAVC-70ZS	197	RCK-18	82
HXLP-3-12	307	M622C	197	MVX-193	88	RCK-25	82
I128SYS	291	M625C	197	MVXA-2016	88	RCK-30	82
I128SYSM	291	M625W	197	One MAESTRO	197	RCK-700	82
I8S	288	M800SW	197	P900	216	RCMR-15	184
I8S-CK	280	M812C	197	PA1001G	27	RLM-24	112
I8SC	289	M812S2T7-BX-RS	275	PA40G	26	RLM-24-5	112
I8SC-CK	281	MA40G	22	PA601	27	ROCKFA62T-BR	159
I8SCH	289	MA60G	22	PA60G	26	RPM-2	112
I8SCH-CK	281	MAC	327	PA702-RMK	45	RPM-4	112
I8SCM	290	MAC-1	328	PB11XCH	323	RR14	83
I8SCM-CK	282	MAESTRO	197	PB11XEB	323	RR21	83
I8SM	288	MAESTROSWR	197	PB15CH	323	RR24	83
I8SM-CK	280	MAESTROSWR-CP	197	PB15EB	323	RR310	83
IDT12-CK	283	MICCLIP	325	PB21XCH	323	RR312	83
IDT12M-CK	283	MLE-1	186	PB21XEB	323	RR316	83
IED1542NA-C	42	MLE-1T	186	PBB-K	333	RR324	83
IED1542NA-D	41	MLE-3	187	PCD3-16-052	84	RR335	83

RR35	83	SHRSB3	85	T95-8-10	244	VPCS-3GPB-245	203
RR40	83	SHRSB4	85	T96-8-7	244	VPK-HR	79
RR44	83	SM12CXT-B	152	TM-1	327	VPVT-4PB	203
RSCW100	87	SM12CXT-W	152	TM-1E	327	VT-152UCN	206
RSCW500	87	SM12SUB70-B	153	TP1100	197	VT-152UCR	206
RWL2	91	SM12SUB70-W	153	TP1200	197	VT-157UCN	206
RX14-25	70	SM181-78-8	242	TP2400	197	VT-157URC	206
RX14-25SFD	70	SM191-78	242	TPP-25	80	VTF-152UCN	206
RX14-30	70	SM194-78	242	TPP-30	80	VTF-152UCR	206
RX14-30SFD	70	SM194-812	243	TPP-36	80	VTF-157-UCN	206
RX21-25	71	SM195-812	243	TPS-25	80	VTF-157UCR	206
RX21-25SFD	71	SM195-89	243	TPS-30	80	WD417-25	155
RX21-30	71	SM42T-B	150	TPS-36	80	WD417-72	155
RX21-30SFD	71	SM42T-WH	150	TSD-ALC2	262	WD417-72V	155
S162T-USA	131	SM52T-B	151	TSD-BB22	12, 249	WMA10-23	64
SB11WE	317	SM52T-WH	151	TSD-BB44	12, 249	WMA12-19-HR	78
SB36CSTR	333	SM82T-B	151	TSD-DA13	23, 251	WMA12-23	64
SB36W	317	SM82T-WH	151	TSD-DA28	23, 251	WMA16-19-HR	78
SB36WE	317	SM8CXT-B	152	TSD-DCPD	265	WMA16-23	64
SBK-700	51	SM8CXT-W	152	TSD-DCPDV	265	WMA24-23	65
SC-15	184	SM8SUB70-B	153	TSD-GPN1200	260, 271	WMA35-23	65
SC-15-45	184	SM8SUB70-W	153	TSD-HF11	263	WME150	87
SD2-14	84	SMA-12	165	TSD-MIX31RL	257	WPD-KSWCC	105
SD3-14	84	SMA-15	165	TSD-MIX32RL	257	WPD-KSWM	105
SD4-14	84	SMBS	154	TSD-MIX41	256	WPD-MIX42RT	258
SD6-14	84	SMP-12	165	TSD-MIX42RT	258	WPD-SWCC	105
SD72	142	SMP-15	165	TSD-ML11	255	WPD-SWM	105
SD722W	143	SMS2B	320	TSD-ML22VCA	255	WPD-VC10K	45
SD72W	142	SMS5B	313	TSD-PA10VG	28, 252	WR-5AT	182
SD72WV	143	SPF2	80	TSD-PA122G	29, 253	XX4707700	333
SE175-4	241	SPR1	80	TSD-PA20VG	28, 252	ZC1	293
SE198-4	241	SPR1-HR	78	TSD-PA252G	29, 253	ZC1-CK	285
SEA-I8S	244	SPR2	80	TSD-PS24V2500MA	266	ZC1PRO	294
SEA-I8SC	245	SPR2-HR	78	TSD-PS24V250MA	266	ZC1PRO-CK	286
SEC1	80	SPR3	80	TSD-PS24V500MA	266	ZC2	293
SEC2	80	SPR3-HR	78	TSD-RL11	256	ZC2-CK	285
SEC3	80	SPR4	80	TSD-RMK	266	ZC2PRO	294
SEST-I8S	245	SPR5	80	TSD-RMKHR	266	ZC2PRO-CK	286
SEST-I8SC	246	SPR6	80	TSD-SEQ6	98, 260		
SEST-IH	245	SPR7	80	TSD-TXHL	263		
SG-38GH	308	SPR8	80	TSD-ZDC	262		
SG-NL4MP-1	309	SS500E	324	UHT25C-U161-8	205		
SG-NL4MP-2	309	SSA7	324	UHT25C-U51-8	205		
SG-QTRSL-F1	309	SSAA5	164	UHT70C-U161-8	205		
SG-QTRSL-F2	309	SW118A	195	UHT70C-U51-8	205		
SG-XLR-F1	307	SW118X	195	UKT25-2C-U161-8	205		
SG-XLR-F2	308	T10	163	UKT25-2C-U51-8	205		
SG-XLR-M1	308	T18	164	UKT70-2C-U161-8	205		
SG-XLR-M2	308	T1930	315	UKT70-2C-U51-8	205		
SH-CK	85	T20	164	VLS44	91		
SH1-10	85	T3664	315	VP14ENC	154		
SH1-10-HR	79	T51-4	221	VP14MB	154		
SH2-15	85	T51-8	222	VP161A-R4	224		
SH2-22	85	T51-84	221	VP161A-R8	224		
SH3-15	85	T61-8W	222	VP410-2	225		
SH3-22	85	T62-8	222	VP60R	224		
SH4-15	85	T720-4	223	VPB-1A	202		
SH4-22	85	T720-4BT	223	VPCS-2G-2	203		
SHRSB2	85	T720-8A	223	VPCS-2GPB-2	203		

Atlas Rules

- Engineer It Right
- Build It Right
- Sell It Right
- Support It Right



Celebrating our 80TH year as an American owned manufacturing company dedicated to innovation and technology providing everything you need to be in the audio/video industry.



Scan for Digital Version



1601 Jack McKay Blvd., Ennis, TX 75119 U.S.A. 800.876.3333

© 2013 Atlas Sound LP. All Rights Reserved. Atlas Sound and Strategy Series® are registered trademarks of Atlas Sound LP. All other trademarks are the property of their respective owners.

ATLASSOUND.COM

ATS004579 RevA 5/13 484141