

DESCRIPTION

The VHB is designed for a wide variety of applications and mounting heights with a balance of fixture performance and affordability. Precision designed optics, multiple distributions, lumen outputs and color temperatures make the VHB ideal for industrial, commercial, manufacturing, gymnasium and other applications that utilize traditional linear fluorescent and HID high bays. The proprietary discrete, low-brightness LED module assembly offers exceptional optical performance with the enhanced benefits of LED lighting, including energy savings, extended system life, a reduced carbon footprint.

Catalog #		Type
Project		
Comments		Date
Prepared by		

SPECIFICATION FEATURES

Construction

Durable CRS and extruded aluminum housing provides added protection for LED components and optimal performance. Compact 15in x 18in low-profile design for a less obtrusive installation.

Electrical

Long-life LED system coupled with electrical driver to deliver optimal performance. LED's available in 3500K, 4000K and 5000K with a CRI ≥ 80. cULus listed. Electronic drivers are available for 120-277V, 347V and 480V applications. Standard 0-10V dimming. Or, specify the Digital Addressable Lighting Interface (DALI) drivers for use with Fifth Light controls.

Finish

White enamel finish preceded by a multistage cleaning cycle, iron phosphate coating with rust inhibitor to protect against contaminants and oxidation.

Optics

Precision designed, high-impact polycarbonate optics deliver even illumination. Narrow and wide distribution ensures superior performance to key areas within an application.

Options

Integral Occupancy Sensor available and provides 1200 sq. ft. of coverage in a maximum mounting height of 30'.

Mounting

The VHB LED series is ideally suited for suspension mounting with standard V Hangers(included) and optional chain set, or cable mounting. Single-point mounting is also available with SPM adapter kit.

Compliance

Luminaires are cULus listed for damp locations -20°C - 40°C ambient environments with 0-10V drivers (see chart). RoHS compliant, and LED modules comply with IESNA LM-79 and LM-80 standards. DesignLights Consortium™ Qualified and classified for DLC Standard, refer to www.designlights.org for details.



**VHB
LED**

LED High Bay Luminaire

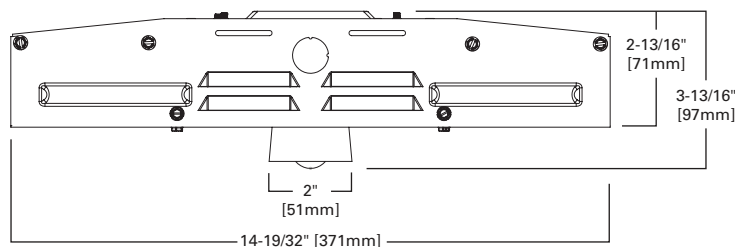

DIMENSION TOP VIEW

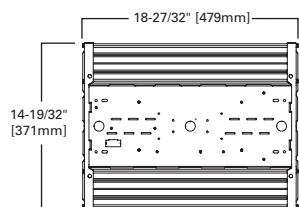

ENERGY DATA

Input Watts:
 VHB-LD1-9 (9,000 lumens)=70W
 VHB-LD1-12 (12,000 lumens)=100W
 VHB-LD1-18 (18,000 lumens)=159W

LINEAR DISCONNECT

Safe and convenient means of disconnecting power



PHOTOMETRICS

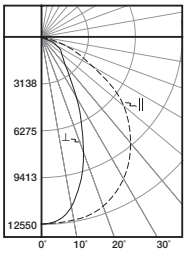

VHBLED-LD1-18-N-UNV-L840-CD-U
 Electronic Driver
 Linear LED 4000K
 Spacing criterion: (II) 1.29 x mounting height, (⊥) 0.77 x mounting height
 Lumens: 18322
 Input Watts: 159.8W
 Efficacy: 114.7 lm/W
 Test Report: VHBLED-LD1-18-N-UNV-L840-CD-U.IES

Candlepower			
Angle	Along II	45°	Across ⊥
0	12502	12502	12502
5	12497	12338	12296
10	12410	11902	11507
15	12257	11015	10013
20	12029	9711	8155
25	11543	8144	6158
30	10890	6380	4537
35	10137	4676	3321
40	9303	3358	2529
45	8293	2534	2053
50	7114	1963	1719
55	5671	1546	1489
60	4125	1250	1139
65	2760	997	728
70	1742	642	391
75	1049	353	151
80	544	123	85
85	202	69	41
90	0	0	0

Coefficients of Utilization

rc rw RCR	Effective floor cavity reflectance 20%																	
	80%			70%			50%			30%			10%			0%		
	70	50	30	70	50	30	70	50	30	70	50	30	70	50	30	0		
0	119	119	119	119	116	116	116	116	111	111	111	106	106	106	102	102	102	100
1	111	107	104	101	109	105	102	99	101	99	96	97	95	93	94	92	91	89
2	103	97	91	86	101	95	90	85	91	87	83	88	85	82	85	82	80	78
3	96	87	80	75	94	86	79	74	83	77	73	80	76	72	78	74	71	69
4	89	79	72	66	87	78	71	66	75	69	65	73	68	64	71	67	63	61
5	83	72	64	59	81	71	64	59	69	63	58	67	62	57	66	61	57	55
6	78	66	58	53	76	65	58	53	64	57	52	62	56	52	61	55	51	50
7	73	61	53	48	71	60	53	48	59	52	48	57	52	47	56	51	47	45
8	68	56	49	44	67	56	49	44	55	48	43	53	48	43	52	47	43	41
9	64	52	45	40	63	52	45	40	51	44	40	50	44	40	49	44	40	38
10	61	49	42	37	60	49	42	37	48	41	37	47	41	37	46	41	37	35

Zonal Lumen Summary

Zone	Lumens	% Fixture
0-30	8151	44.5
0-40	11720	64.0
0-60	16521	90.2
0-90	18322	100.0
0-180	18322	100.0

Luminance Data

Angle in Deg	Average 0-Deg cd/sm	Average 45-Deg cd/sm	Average 90-Deg cd/sm
45	144274	44084	35716
55	121627	33157	31935
65	80338	29021	21191
75	49859	16778	7177
85	28511	9739	5787

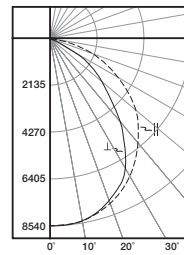

VHBLED-LD1-18-W-UNV-L850-CD-U
 Electronic Driver
 Linear LED 5000K
 Spacing criterion: (II) 1.26 x mounting height, (⊥) 1.19 x mounting height
 Lumens: 19263
 Input Watts: 159.5W
 Efficacy: 121 lm/W
 Test Report: VHBLED-LD1-18-W-UNV-L850-CD-U.IES

Candlepower			
Angle	Along II	45°	Across ⊥
0	8518	8518	8518
5	8491	8484	8527
10	8385	8390	8421
15	8229	8225	8228
20	7986	7961	7886
25	7640	7570	7445
30	7236	7116	6806
35	6791	6487	5942
40	6279	5690	4896
45	5661	4750	3880
50	5054	3730	3012
55	4342	2791	2420
60	3616	2113	1376
65	2861	1477	614
70	2134	687	318
75	1398	321	157
80	715	116	91
85	226	61	45
90	0	0	0

Coefficients of Utilization

rc rw RCR	Effective floor cavity reflectance 20%																	
	80%			70%			50%			30%			10%			%		
	70	50	30	70	50	30	70	50	30	70	50	30	70	50	30	0		
0	119	119	119	119	116	116	116	116	111	111	111	106	106	106	102	102	102	100
1	111	107	103	100	108	104	101	98	100	97	95	96	94	92	93	91	89	87
2	102	95	89	84	99	93	87	83	89	85	81	86	82	79	83	80	77	75
3	94	84	77	71	91	83	76	71	80	74	70	77	72	68	75	71	67	65
4	86	76	68	62	84	74	67	61	72	65	60	70	64	60	68	63	59	57
5	80	68	60	54	78	67	59	54	65	58	53	63	57	52	61	56	52	50
6	74	62	54	48	72	61	53	47	59	52	47	58	51	47	56	50	46	44
7	69	56	48	42	67	56	48	42	54	47	42	53	46	42	51	46	41	40
8	64	52	44	38	63	51	43	38	50	43	38	48	42	38	47	42	37	36
9	60	48	40	35	59	47	40	34	46	39	34	45	39	34	44	38	34	32
10	57	44	36	31	55	43	36	31	43	36	31	42	35	31	41	35	31	29

Zonal Lumen Summary

Zone	Lumens	% Fixture
0-30	6610	34.3
0-40	10615	55.1
0-60	17082	88.7
0-90	19263	100.0
0-180	19263	100.0

Luminance Data

Angle in Deg	Average 0-Deg cd/sm	Average 45-Deg cd/sm	Average 90-Deg cd/sm
45	98485	82636	67501
55	93124	59859	51902
65	83278	42993	17872
75	66447	15257	7462
85	31899	8610	6352

LUMEN MAINTENANCE

Ambient Temperature	TM-21 Lumen Maintenance (60,000 hours)	Theoretical L70 (Hours)
40°C	> 83%	> 114,000

ENERGY AND PERFORMANCE DATA BY CATALOG NUMBER

Catalog Number	Delivered Lumens	Watts	Efficacy (lm/W)
Narrow			
VHBLED-LD1-9-N-UNV-L835-CD1-U	8508	70	122
VHBLED-LD1-9-N-UNV-L840-CD1-U	8885	70	127
VHBLED-LD1-9-N-UNV-L850-CD1-U	8999	70	129
VHBLED-LD1-12-N-UNV-L835-CD1-U	11849	100	118
VHBLED-LD1-12-N-UNV-L840-CD1-U	12374	100	124
VHBLED-LD1-12-N-UNV-L850-CD1-U	12533	100	125
VHBLED-LD1-18-N-UNV-L835-CD1-U	17546	160	110
VHBLED-LD1-18-N-UNV-L840-CD1-U	18323	160	115
VHBLED-LD1-18-N-UNV-L850-CD1-U	18559	160	116
Wide			
VHBLED-LD1-9-W-UNV-L835-CD1-U	8677	70	124
VHBLED-LD1-9-W-UNV-L840-CD1-U	9004	70	129
VHBLED-LD1-9-W-UNV-L850-CD1-U	9341	70	133
VHBLED-LD1-12-W-UNV-L835-CD1-U	12084	100	121
VHBLED-LD1-12-W-UNV-L840-CD1-U	12540	100	125
VHBLED-LD1-12-W-UNV-L850-CD1-U	13009	100	130
VHBLED-LD1-18-W-UNV-L835-CD1-U	17894	160	112
VHBLED-LD1-18-W-UNV-L840-CD1-U	18568	160	116
VHBLED-LD1-18-W-UNV-L850-CD1-U	19263	160	120

AMBIENT RATINGS

Lumen Package	Ambient Rating	EM Battery (Remote)
VHBLED-LD1-9	40°C	40°C
VHBLED-LD1-12	40°C	40°C
VHBLED-LD1-18	40°C	40°C

ORDERING INFORMATION

SAMPLE NUMBER: VHBLED-LD1-12-W-UNV-L840-CD1-U Includes V Hangers for rapid installation

<p>Series ⁽¹⁰⁾ VHBLED=LED High Bay</p>		<p>Voltage ⁽¹¹⁾ UNV=Universal Voltage 120-277 UNC=Universal Voltage 347/480</p>	<p>Driver Type CD=0-10V Dimming Driver 5LTD=Fifth Light DALI (9,000 and 12,000 lumen versions only)</p>	<p>Options MP=Modular Power Receptacle (used for all Cord or Cord and Plug options) ⁽⁷⁾ PAF=Painted After Fabrication</p>	<p>Packaging U=Unit Pack PALC=Job Pack In Carton</p>
<p>Lamp Type LD1=LED 1.0</p>		<p>CCT L835=3500K L840=4000K L850=5000K</p>	<p>Number of Drivers 1=1 Driver (9,000, 12,000, 18,000 lumen versions)</p>	<p>Motion Sensors MS=360° or 180° Motion Sensor Installed, (specify voltage) ⁽⁶⁾ SVPD3=Integrated occupancy and daylight dimming sensor, 1200 sq. ft. coverage ⁽⁶⁾ LWR=LumaWatt Wireless Sensor system ⁽⁶⁾</p>	
<p>LED Lumen Output 9=9,000 Lumens 12=12,000 Lumens 18=18,000 Lumens</p>		<p>Options Emergency EL20W-REM=20-watt, 120V-277V emergency battery pack remote mounted ⁽⁴⁾</p>		<p>Accessories (order separately) VHB-SPM=Single Point Mount Adapter Kit ^{(2), (3), (8)} LOOP-10=Ten Foot Loop Hanger, #2 Cable ⁽⁹⁾ LOOP-30=Thirty Foot Loop Hanger, #2 Cable ⁽⁹⁾ FL-1=Fixture Loop ⁽¹¹⁾ SHK=Fixture Hook ⁽¹¹⁾ Y-TOGGLE=Y Mounting Toggle, #2 Cable (Specify 10' or 30') HBAYC-CHAIN/SET/U=(2) V-Hook Hangers, 36" Chain Sets w/S-Hooks VHB-WG=Field Installable, Wireguard for VHB ⁽⁵⁾ MPC3=3' Modular Power Cord & Plug (Specify Voltage) MC6=6' Modular Power Cord MPC6=6' Modular Power Cord & Plug (Specify Voltage) ISHH-01=Programming Remote for Integrated Sensor ISHH-02=Personal Control Remote for Integrated Sensor</p>	
<p>Distribution N=Narrow (Aisle) W=Wide (General)</p>					
<p>Shielding [Blank]=High Impact Polycarbonate Lens</p>					

NOTES: ⁽¹⁾ Voltage must be specified when ordering accessory cord and plug. ⁽²⁾ Fixture cannot be surfaced mounted and must be a minimum of 18 inches below ceiling surface. ⁽³⁾ Single point mounting requires counterbalance weight which is included in the VHB-SPM kit. ⁽⁴⁾ EL20EM-REM requires remote mount only. ⁽⁵⁾ Wireguard option is field installable only. ⁽⁶⁾ When ordering MS, SVPD3, or LWR option, specify as UNV (for 120 or 277V), or 347V, or 480V. ⁽⁷⁾ Requires use of MC pr MPC cord accessories. ⁽⁸⁾ Rigid mount not for use in gymnasiums. ⁽⁹⁾ The accessory Loop Hanger shall be utilized only as a secondary safety and not the primary means of mounting. ⁽¹⁰⁾ DesignLights Consortium™ Qualified and classified for DLC Standard, refer to www.designlights.org for details. ⁽¹¹⁾ Must be used in conjunction with VHB-SPM accessory for proper attachment to fixture.

Specifications & dimensions subject to change without notice. Consult your Eaton Representative for availability and ordering information.

Modular F-Bay Power Supply Option

Cooper Lighting's F-Bay Modular Power Supply option is available for use with all F-Bay products. The modular power supply allows external fixture access for safe and easy servicing. There is no need to remove lamps or reflectors to disconnect fixture power with F-Bay Modular Power Supply. Access to the individual fixture's power supply allows servicing without turning off all the fixtures, disrupting occupants. F-Bay Modular Power Supply is a time saver in installation – **simply plug & power.**



1. Modular Power Supply Receptacle supplied mounted into fixture Access Plate
 2. Modular Power Cord & Plugs in 120, 277, 347, & 480V configurations for easy plug & power into existing supply
- No internal fixture access required for installation or disconnecting power

Code Compliance

- UL/cUL Certified for Make/Break under load (UL2549)
- Meets NEC requirements for ballast disconnect (NEC 410.73G)
- Allows for addition of Occupancy Sensor without hard connections
- Receptacles complete with insulating/dust cap

SHIPPING DATA

Catalog No.	Wt.
VHBLED-LD1-9	15 lbs.
VHBLED-LD1-12	15 lbs.
VHBLED-LD1-18	15 lbs.

INTEGRATED SENSOR

The VHB with Integrated Sensor technology provides automatic energy savings without sacrificing performance. Traditionally, these types of energy savings required coordination between the luminaire and a lighting control system. The VHB delivers superior lighting with integrated occupancy and daylighting controls.

Capture the benefits of traditional lighting controls, without complicated coverage planning or special wiring. Ideal for new construction or retrofit, the VHB delivers automatic ON to an energy saving light level, while ensuring lighting is turned OFF when the space is unoccupied.

The integral daylight sensor reduces the need for special daylight zone planning. Each luminaire will automatically adjust the light level based on reflected light beneath the sensor in a closed loop method.

Occupied daylight light levels and unoccupied light levels can be adjusted using the integrated sensor programming remote (Catalog Number: ISHH-01). The integrated sensor personal remote (Catalog Number: ISHH-02) provides code compliant manual raise, lower, ON, OFF control.

The VHB with Integrated Sensor is easy to install with no special wiring and ensures energy savings out-of-the-box with default control settings.

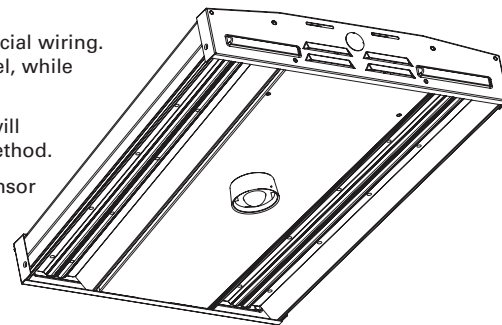

How it works:

- As the user enters the space controlled by the integral sensor, the lighting turns ON to the default daylight level.
- Lighting will remain at that the daylight level until the space is unoccupied. This will start the occupancy timeout period (default 20 minutes).
- If the space remains unoccupied for half of the timeout period, the lighting will automatically reduce to the Energy Saver light level. This adjustable light level is typically half of the occupied daylight level.
- At the end of the timeout period the lighting will go to the unoccupied light level. This adjustable light level uses the OFF default setting.

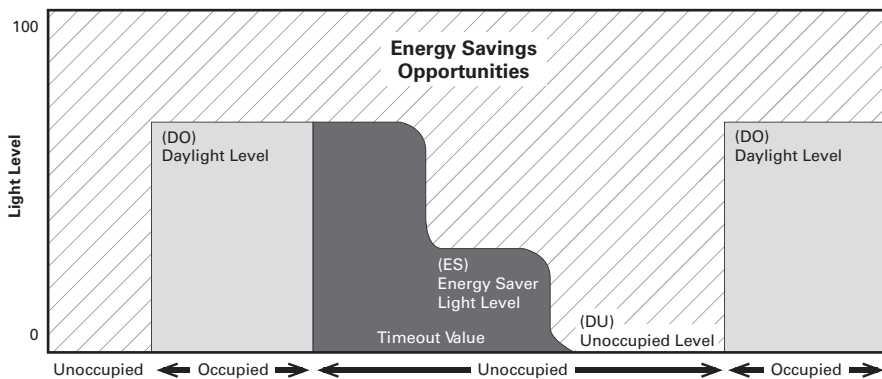

Default daylight harvesting set using 36,000 lumen unit at 30 ft. mounting height, 20 ft. spacing for 50 footcandles.

SVPD3 Coverage Pattern

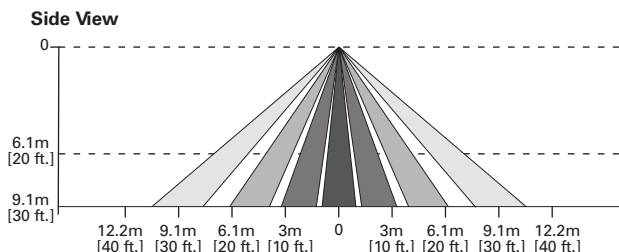

Optional Remote Controls



ISHH-01 Remote



ISHH-02 Remote