

*Right side removed to show interior of cabinet

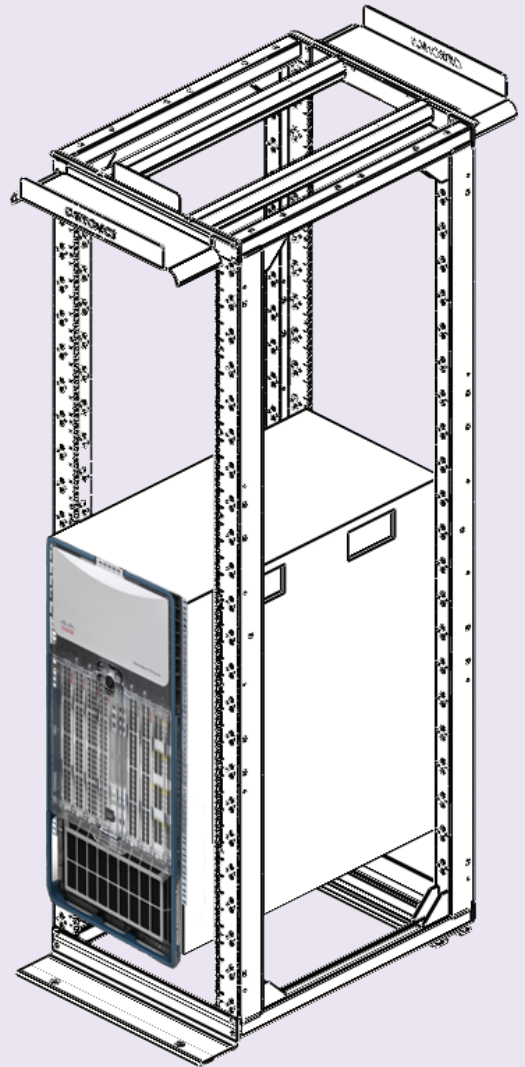

Mighty Mo[®] Cabinet and Four-Post Rack Solutions

FOR THE CISCO NEXUS 7010 SWITCH

Legrand | Ortronics
is a Cisco Verified
Cabinet Vendor for
the Nexus 7010
Data Center Switch



Ortronics

THE CISCO NEXUS 7000 SERIES SWITCHES ARE DESIGNED TO OPTIMIZE AVAILABILITY, RELIABILITY, EASE OF MANAGEMENT, AND DEPLOYMENT OF A HIGHLY SCALABLE 10 GIGABIT ETHERNET NETWORK TO MEET THE REQUIREMENTS OF EVOLVING MISSION-CRITICAL DATA CENTERS.



Ortronics® Mighty Mo Cabinets and Mighty Mo 10 Four-Post Racks boast industry leading cable management features that address the high density requirements in the data center and SAN environments of today and the future. The Mighty Mo advanced cable management system includes a complete array of accessories to create customized solutions for a wide variety of network and data center configurations.

The Mighty Mo Cabinets and Mighty Mo 10 Four-Post Racks are designed around industry leading cable management systems that provide above the standard performance and capabilities for handling the requirements of the Cisco Nexus 7010 Data Center switch:

- Protection & Performance
- Density
- Airflow
- Power

Protection & Performance

Mighty Mo Cabinet and Mighty Mo 10 Four-Post Rack:

- Ample space for two Nexus 7010 Switch 10-slot chassis using:
 - Mighty Mo Cabinet with 40” and deeper frames (47 rack units)
 - 7’ Mighty Mo 10 Four-Post Rack (45 rack units)
- Static capacity to support the weight of two fully configured Nexus 7010 Switches:
 - Mighty Mo Cabinet: 2000 lbs. 
 - Mighty Mo 10 Four-Post Rack: 1500lbs. 
- To ensure maximum network performance, Mighty Mo cable management systems protect patch cords, cables and equipment ports from damage by:
 - Maintaining proper bend radius requirements
 - Reducing tension on plugs and jacks
 - Protecting network equipment ports
 - Supporting large cable bundles within the rack

Layer Zero™ NETWORK DESIGN

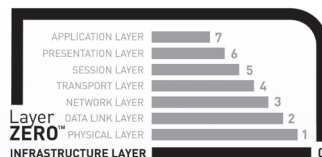

Legrand | Ortronics is revolutionizing networking by adding a new layer to the traditional network architecture. The OSI network model is the accepted framework for network design and suggests seven layers to use for network planning. The bottom layer of this model is Layer One – the physical layer, which is the structured cabling itself, but what Layer One does not include is the physical SUPPORT, or the infrastructure, for the cabling.

Legrand | Ortronics introduces Layer Zero as a new foundation for the OSI model to address the critical role that infrastructure plays in network performance and provide a new level of stability to the network. To ensure maximum network efficiency, we offer a complete range of Layer Zero solutions designed to:

- Reduce power consumption and cooling costs
- Reduce the risk of equipment failure
- Enhance overall system performance



BENEFITS of the Mighty Mo Cabinet and Mighty Mo 10 Four-Post Rack

Density

Mighty Mo Cabinet:

- Support for up to 900 Cat 6 ports (The Nexus 7010 is capable of handling as many as 384 Gigabit Ethernet ports.)
- Vertical managers provide ample capacity for a minimum of 48 Category 6A patch cords per rack unit on a single side of the equipment

Mighty Mo 10 Four-Post Rack:

- Support for up to 1340 Cat 6 ports (The Nexus 7010 is capable of handling as many as 384 Gigabit Ethernet ports.)
- Vertical managers provide ample capacity for a minimum of 48 Category 6A patch cords per rack unit on a single side of the equipment
- Mounting rails adjust from 12.5" to 30", independent of the structural members allowing the rails to be adjusted after the rack is installed. Mighty Mo vertical managers can be mounted front or rear.

Airflow

Mighty Mo Cabinet:

- The Mighty Mo Cabinet is ideal for maintaining cold-aisle/hot aisle airflow, whether your network equipment is front-to-back, bottom or side venting.
- As the Cisco Nexus 7010 Switch utilizes front-to-back cooling, the Mighty Mo airflow dams (barriers) can facilitate proper front-to-back cooling by eliminating recirculation.

Mighty Mo 10 Four-Post Rack:

- As the Cisco Nexus 7010 Switch utilizes front-to-back cooling, the need for airflow baffles is eliminated as the basic design of the Mighty Mo 10 can facilitate proper front-to-back cooling as is.

* Mighty Mo Four-Post Racks meet the Rack Requirements set forth in the Cisco Nexus 7000 Series Site Preparation Guide. Contact your Ortronics sales representative to select your Mighty Mo 4-post rack solution.

Power

Mighty Mo Cabinet and Mighty Mo 10 Four-Post Rack:

- Full size Power Distribution Units (PDUs) are mountable on Mighty Mo PDU mounting brackets and the Mighty Mo 10 Four-Post Rack wide back rails, with the switch already mounted, to bring additional power to your cabinet.

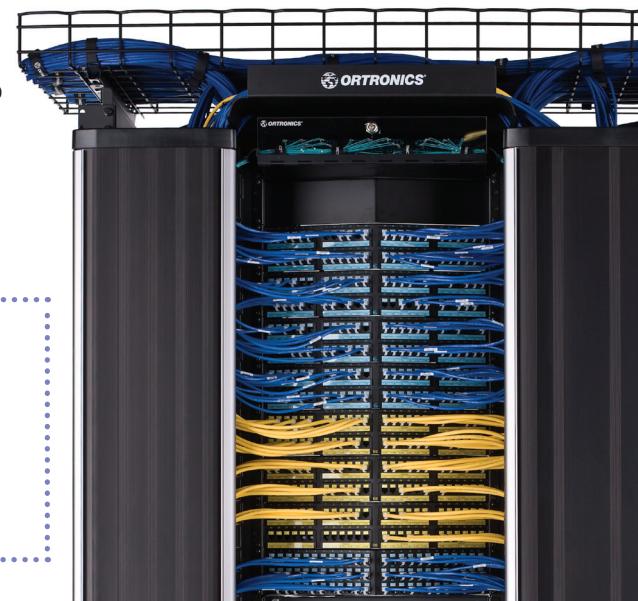

Cisco Verified Mighty Mo Cabinet for the Nexus 7010 Data Center Switch

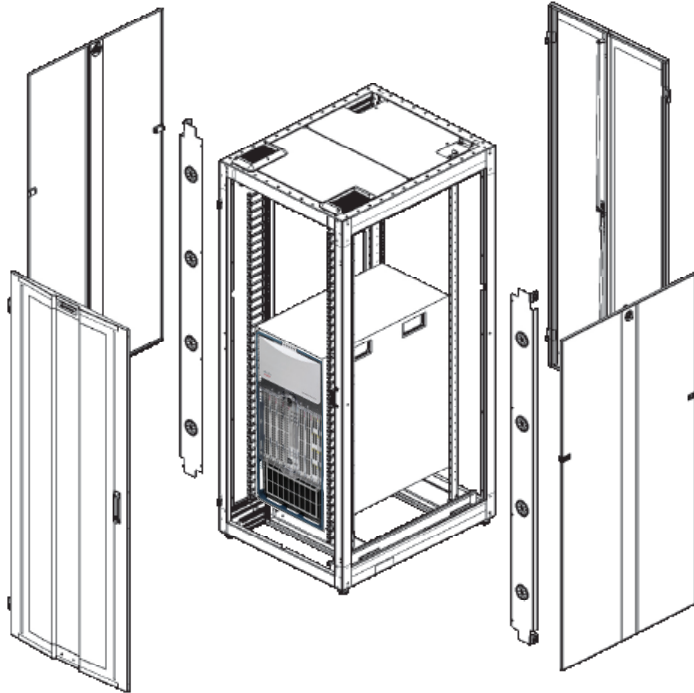

Pre-Configured Cabinets for the Nexus 7010

All pre-configured cabinet versions include:

- Frame configured with cable opening at bottom front
- Frame levelers
- Two pairs of RU labeled mounting rails with #12-24 tapped holes
- Full profile perforated front door and split flat mesh rear door
- Two "L" shaped finger managers on front rails with 12 bend limiters
- Mighty Mo Cabinet Air Dam Kits for the Nexus 7010
- Right and left locking side panels
- Cable entry top panel on front and rear with brush guards on front
- Package of 50 panel mounting screws #12-24

Pre-Configured Mighty Mo Cabinets

with Air Dam Kit as shown above

PART NO.	DESCRIPTION
OR-MMC423240-0001J	42RU x 32" wide x 42" deep, black
OR-MMC423246-00016	42RU x 32" wide x 48" deep, black
OR-MMC473240-0000L	47RU x 32" wide x 42" deep, black
OR-MMC473246-0000H	47RU x 32" wide x 48" deep, black

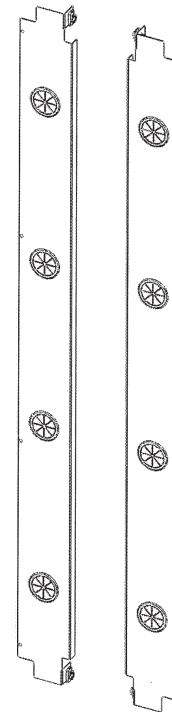

Mighty Mo Cabinet Air Dam Kits for the Nexus 7010

PART NO.	DESCRIPTION
OR-MMC4232ADK	For 42RU x 32" wide cabinets, black
OR-MMC4732ADK	For 47RU x 32" wide cabinets, black

NOTE: Can be ordered separately to install in existing Mighty Mo cabinet frames that are 32" wide x 40" or 46" depth. Contact your Ortronics sales representative to custom configure your Mighty Mo Nexus 7010 cabinet with casters, additional cable management, open sides for ganging and other options. Mounting hardware and instructions included in Air Dam Kit.

designed to be better.™



North America Headquarters
60 Woodlawn Street
West Hartford, CT 06110
Phone: 1.877.BY.LEGRAND (295.3472)
www.legrand.us

570 Applewood Crescent
Vaughan, Ontario L4K 4B4
Phone: 905.738.9195
www.legrand.ca

Ortronics
125 Eugene O'Neill Drive
New London, CT 06320
Tel: (860) 445-3800