

A woman with curly hair is holding a glowing, spherical object in her hand, looking up at it with a focused expression. The background is blurred, suggesting an indoor setting with warm lighting.

**PHILIPS
ADVANCE**

Product Catalog

The right components for **your application**

2016-2017 Atlas Full Line Guide to LED Drivers, LED Modules,
Ballasts and Lighting Controls

Table of contents

1-1 LED Drivers

2-1 LED Modules

3-1 Electronic Fluorescent Ballasts

4-1 Fluorescent Controllable Ballasts

5-1 Electromagnetic Fluorescent Ballasts

6-1 Electronic HID Ballasts

7-1 Magnetic HID Ballasts

8-1 Controls

9-1 Reference

For the latest product updates, please visit:

LED Drivers and Modules
Ballasts
Controls

www.philips.com/oemna
www.philips.com/oemna
www.philips.com/lightingcontrolsna

Atlas Full Line Catalog

The right solutions to make a difference

With the broadest selection of industry leading components across all lighting technologies, including HID, fluorescent, LED and more, trust Philips to help sustain your success. We have the expertise and high-quality solutions to meet the lighting goals of your customers and one-stop shopping convenience to simplify your procurement.

Each component is sustainably manufactured to the highest standards. As part of this goal, we strive to achieve full RoHS compliance for all products to minimize harmful impact to the environment. Additionally, we participate in the Conflict Free Tin Initiative¹, pledging to source minerals and materials only from conflict-free supply chains.

We also test all components to the highest standards – such as Energy Star, US, ANSI and more – to ensure robust and long-lasting performance.

By operating in this manner, we can help users to reduce energy consumption and related costs, stay ahead of changing government regulations and reflect an environmentally friendly image.

Throughout this catalog, you have fast access to the latest LED and traditional lighting technology components that best meet your needs and those of your customers.



Online tools at your fingertips

Online OEM Lighting Components provides you with...

- Online access to the entire OEM Lighting Components portfolio.
- An easy format to search by product type or name.
- Up-to-date product information so you can always find current specs and literature.
- Drop down menus to help you further refine your options and find the exact product you are looking for.

philips.com/oemna



Easy Design-in Tool provides you with...

- Fast and easy web-based methods to create your ideal system configuration.
- Flexible component choices to inspire your creativity.
- User-friendly graphic interface to save time.

www.na.easydesignintool.philips.com



Online news at your fingertips

The Philips Lighting Blog provides you with...

- A platform to learn more about our latest products and installations.
- A direct connection to thought leaders and product experts within Philips.
- The opportunity to learn more about LED technology, design, sustainability and other important industry topics.
- A chance to contribute to discussions by offering your own insights and experiences.

philips.com/lightingblog



The Philips Twitter Account provides you with...



- Important industry news.
- New product announcements and blog posts.
- Information on our latest lighting installations.

<https://twitter.com/PhilipsLight>

Philips Innovations in Light provides you with...



- An opportunity to collaborate and share knowledge and ideas.
- A chance to get your questions answered by peers or other industry experts.
- A platform to discuss the challenges and opportunities facing our industry.

www.linkedin.com/company/philips-lighting



LED Drivers

Philips Advance Xitanium LED Drivers	1-1
Philips Advance Xitanium SR LED Drivers	1-2
Philips Advance Xitanium Indoor Linear LED Drivers	1-3
Philips Advance Xitanium Indoor Downlight and Track LED Drivers.....	1-4
Philips Advance Xitanium Outdoor LED Drivers.....	1-5

Corporate Offices
(800) 322-2086

Customer Support/Technical Service
(800) 372-3331 • (+) 1 847 390-5000 (International)

Visit our web site at www.philips.com/leddrivers.

Versatility delivered

Philips Advance Xitanium LED Drivers

For optimal performance, long-lasting and low-maintenance LED Light Sources require reliable and long-lasting LED drivers matching the long lifetime of the LEDs. Our wide range of Philips Advance Xitanium LED Drivers is specifically designed to operate LEDs in a variety of indoor and outdoor lighting applications and also to meet a wide variety of customer needs, but they can all provide certain common benefits.

Including:

- Reliable and consistent operation
- High efficiency >90% in some cases
- Greater than 0.9 PF and less than 20% THD
- Greater than 50k hrs¹ lifetime
- 5-year limited warranty²
- ROHS compliance³

Philips Advance Xitanium LED Drivers are offered in the following categories:

Fixed

Fixed LED drivers meet basic LED lighting needs with either dedicated input voltage or IntelliVolt option, to suit a wide variety of output current and power requirements.

Dimmable

Dimmable drivers address the growing demand for controllability and flexibility. The adjustable output current (AOC) feature enables operation of various LED configurations from different LED manufacturers and offers “future-proof” solutions for new LED generations. Specialized dimmable drivers enable use of lighting controls to increase energy saving through a wide variety of protocols.

Speed up your business with new wireless programmable LED technology

Philips' new SimpleSet wireless programming technology for LED drivers is designed to help OEMs quickly and easily program LED drivers at any time during the manufacturing, distribution or installation process. Go to www.philips.com/simpleset for more information.

Additional dimmable LED Driver benefits:

- Wide variety of dimming interfaces (0-10V, Phase Cut, Step-Dim)
- Helps address code requirements for energy efficient buildings
- Fixture design flexibility through the AOC feature
- Options such as fan output and module temperature protection

For more driver information, visit www.philips.com/leddrivers or contact your local Philips sales representative.

1. Philips Advance Xitanium LED Drivers are designed and manufactured to engineering standards correlating to an average life expectancy of 50,000 hours of operation at maximum rated case temperature. Minimum 90% survivals based on MTBF modeling.

2. View limited warranty at <http://www.usa.lighting.philips.com/support/support/warranty> for details and restrictions.

3. Restrictions on Hazardous Substances (RoHS) is a European directive (2002/95/EC) designed to limit the content of 6 substances [lead, mercury, cadmium, hexavalent chromium, polybrominated biphenyls (PBB), and polybrominated diphenyl ethers (PBDE)] in electrical and electronic products. For products used in North America compliance to RoHS is voluntary and self-certified.

Wireless, connected, streamlined

Philips Advance Xitanium SR LED Drivers

Uncomplicated and amenable to any sensor or network

In today's digital age, people can gather real-time data and use it to make highly informed decisions in areas from personal finance to time management and much more. However, this method of detailed insight is not relegated to personal use. In fact, it's now possible to wirelessly harvest specific, real-time lighting information in commercial spaces.

Philips Advance Xitanium SR LED Drivers streamline wireless connected lighting. They reduce overall costs by standardizing the digital connection between the driver and sensor, bundling important functionality into the driver and eliminating the need for auxiliary components. Xitanium SR Drivers enable power reporting and dim/on/off functionality at each fixture.

This streamlined approach and easy design-in means that OEMs can spend less time and money to bring products to market. And for your customers, Xitanium SR LED Drivers enhance energy efficiency by monitoring real-time system data and making this information available at any time to the network. It also manages sensors and commands related to occupancy, daylight harvesting and dim-to-off at each luminaire. Together with Philips, it's never been easier to create robust, cutting-edge wireless lighting solutions.

Simplicity for everyone

Using our Xitanium SR LED Drivers, digital system data is collected at each luminaire and then routed wirelessly through your customers' preferred networks. This means that very specific and actionable data can be used to make informed business decisions and optimize resource distribution within workspaces. Go to www.philips.com/xitaniumsr for more information.

Simplified Luminaire Design



Separate components add unnecessary complexity to luminaires (top), while Xitanium SR LED Drivers integrate many of the components (bottom) for a streamlined luminaire design.

For more driver information, visit www.philips.com/leddrivers or contact your local Philips sales representative.

A perfect partner for indoor lighting

Philips Advance Xitanium Indoor Linear LED Drivers

Philips Advance Xitanium LED Drivers for linear applications are available in three types:

Dimmable

Dimmable drivers include 0-10V, step-dim or leading-edge dimming to integrate into common dimming systems used in commercial applications. Dimming enables maximum energy savings and can help to facilitate worker comfort.

Programmable

These drivers provide a feature set managed through a programmable interface. This allows the OEM to create a fixture portfolio to meet specific needs for a wide range of applications, using a minimum number SKUs to reduce complexity and simplify logistics.

SR

Xitanium SR drivers share the same footprint as the dimmable drivers for simple, hassle-free integration into luminaires. These versatile drivers provide power metering and DC power to the sensor over the DALI 2.0 open standard digital interface.

Philips Advance Xitanium LED Drivers for linear applications are available in wattages up to 95W for hard-wired integration into linear fluorescent style fixtures (troffers). The form factor is perfectly suited to these applications and enables quick time to market by utilizing mechanical aspects familiar in traditional fluorescent fixtures. Go to www.philips.com/leddrivers for more information.

Simplicity for everyone

- Adjustable output current
- Wide operating windows
- UL Class Class 2
- Input voltage range of 120-277V
- High efficiency for maximum payback
- High reliability for low maintenance costs

Applications include:

- Office
- Retail
- Hospitality
- Meeting rooms



Reliable, flexible options

Philips Advance Xitanium Indoor Downlight and Track LED Drivers

Philips Advance Xitanium LED Drivers for indoor downlight and track applications are available in three types:

Fixed output

Fixed output LED drivers set the standard for reliability and performance needed for indoor downlight and track lighting.

Dimmable

Dimmable drivers include 0-10V or leading/trailing-edge dimming to integrate into common dimming systems used in commercial applications. Dimming enables maximum energy savings and can help to facilitate worker comfort.

Programmable

These drivers offer a feature set managed through a programmable interface. This allows the OEM to create a fixture portfolio to meet specific needs for a wide range of applications, using a minimum number of SKUs to reduce complexity and simplify logistics.

Philips Advance Xitanium LED Drivers for indoor downlight and track applications are available in wattages up to 95W for hard-wired integration into recessed downlights and track light fixtures. These LED drivers are available in the familiar SmartMate housing for junction-box mounting in downlights and slim housings for incorporation into track housings. Go to www.philips.com/leddrivers for more information.

Simplicity for everyone

- Adjustable output current
- Wide operating windows
- UL Class Class 2
- Input voltage range of 120-277V
- High efficiency for maximum payback
- High reliability for low maintenance costs

Applications include:

- Office
- Retail
- Hospitality
- Meeting rooms



For more driver information, visit www.philips.com/leddrivers or contact your local Philips sales representative.

The right solution for outdoor applications

Philips Advance Xitanium Outdoor LED Drivers

Xitanium LED Drivers for outdoor applications are available in three types:

Fixed output

Fixed output LED drivers set the standard for reliability and performance needed for outdoor lighting.

Dimmable

These 0-10V dimming drivers help address the growing demand for controllability and flexibility allowing the lighting system to be used with various controls to maximize energy savings.

Programmable

Programmable LED drivers provide a feature set managed through a programmable interface. This allows the OEM to create a fixture portfolio to meet specific needs for a wide range of applications, using a minimum number SKUs to reduce complexity and simplify logistics.

Philips Advance Xitanium LED Drivers for outdoor applications are available in wattages up to 300W for hard-wired integration into outdoor luminaires for the most rugged applications. They operate to specification under wide temperature and electrical ranges to ensure reliability. Go to www.philips.com/leddrivers for more information.

Specific features of this series

- Standard drive currents 350, 530, 700, 1050 and 1500mA
- UL Class 1 or Class 2
- Input voltage ranges of 120-277V or 347-480V
- Surge protection
- High efficiency for maximum payback
- High reliability for low maintenance costs

Applications include:

- Area
- Roadway
- Parking garage
- Gas station canopy
- Wallpacks
- Floodlights



LED Modules



LED Modules	2-1
Fortimo LED Linear Family	2-2
Fortimo LED Point Family	2-3
Philips InteGrade LED Engine and Fixture Systems ..	2-4

Corporate Offices
(800) 322-2086

Customer Support/Technical Service
(800) 372-3331 • (+) 1 847 390-5000 (International)

Visit our web site at www.philips.com/ledmodulesna.

Design flexibility

The Philips LED Module Family – Fortimo and InteGrade

The Philips LED Module Family – Fortimo and InteGrade – offers exceptional quality of light and energy efficiency. The broad module portfolio covers linear, point and display lighting applications and features modules designed to work with Philips Advance Xitanium LED Drivers.

Module Types

Linear modules

Flexible, versatile Fortimo LED modules provide easy design-in for manufacturers seeking to integrate reliable, high-quality components into their luminaires. The Fortimo LED Linear Module Family has been designed to replace fluorescent lighting in new luminaires. By standardizing form factors, Philips has made it easy for designers to fit LED solutions into a variety of linear applications.



Point modules

LED technologies continue to shift the lighting paradigm across all applications, and downlighting is no exception. In fact, downlighting was one of the first lighting applications to commercially embrace LED technology. Fortimo LED Downlight Modules (DLM) and LED Spotlight Module (SLM) provide the latest high quality LED options to satisfy both functions and performance requirements.



Display modules

The Philips InteGrade LED system is an energy efficient way to create an enjoyable shopping experience for customers. The system can be used for display case and linear accent lighting. InteGrade engine and fixture systems are available.



Ideal solution for high-performance linear LED luminaires

Fortimo LED Linear Family

The Fortimo LED Linear Module Family has been designed to replace fluorescent lighting in new luminaires. By standardizing form factors, Philips has made it easy for designers to fit LED solutions into a variety of linear applications, including standard office to high-bay industrial and now into very slim fixtures where fluorescent light might not be suitable.

Fortimo LED Line

Designed to replace general fluorescent lighting in new luminaires, the Fortimo LED Line system goes into the third generation with improved efficiency and the same Zhaga footprint.



Fortimo LED Line High Flux

The Fortimo LED Line High Flux system is ideal for installations at greater application heights where more light output is needed, such as high-bay. It was designed to withstand high ambient temperatures that are common to applications like industry or vapor tight fixtures.



Fortimo LED Strip

The Fortimo LED Strip system enables design of high-energy efficacy slim linear LED fixtures, which may not be possible with fluorescent lighting or the Fortimo LED Line system.



Fortimo LML Slim Efficiency

The Fortimo LML Slim Efficiency system enables an economic fixture design that meets DLC requirements for linear lighting applications replacing T8 lamp equivalents.



Fortimo LED Line SQ system

The Fortimo LED Line SQ system with square outer dimensions is ideal for 2"x2" or 2"x4" recessed office applications that require a very homogeneous (no pixilation) exit surface window and high quality of light.



For more driver information, visit www.philips.com/ledmodulesna or contact your local Philips sales representative.

High-quality options for downlighting applications

Fortimo LED Point Family

Fortimo LED Downlight Module (DLM)

LED technologies continue to shift the lighting paradigm across all applications, and downlighting is no exception. In fact, downlighting was one of the first lighting applications to commercially embrace LED technology. As the technologies continue to evolve, long lifetimes, environmental sustainability and low initial costs attract general commercial audiences requiring functional lighting, while the exponential rise in LED efficiency, light quality and light output are creating new opportunities for high-end, sophisticated applications. The challenge remains for luminaire manufacturers to leverage these valuable advancements with costly and time-consuming retooling while also satisfying functional and performance end user lighting needs.

New Philips Fortimo LED Downlight Module (DLM) and Fortimo LED Downlight Module (DLM) Flex systems now provide you with the latest high quality LED options to satisfy both functional and performance requirements, along with excellent energy efficiencies and color consistency. Best of all, we retained the same familiar DLM footprint so that you don't have to endure the hassles of retooling or redesigning fixtures.



Fortimo LED Spotlight Module (SLM)

The Fortimo LED SLM is a next generation solution for spotlight and downlight applications. Fortimo LED SLM is a product in line with the Fortimo brand promise of light quality. Philips provides a system proposition ranging from 1,100 lm to 4,500 lm in preset outputs, with the flexibility to tune as needed. The product leverages the latest chip-on-board LED technology with a Zhaga Book 3 compliant holder. Being a low voltage UL Class II electrical design and a UL recognized component, Fortimo LED SLM enables easy design-in with Philips Advance Xitanium LED Drivers.



Perfect design partner for display lighting

Philips InteGrade LED Engine and Fixture Systems

Philips InteGrade LED Engine System

The InteGrade LED engine system is an energy-efficient way to create an enjoyable shopping experience for customers. The system can be used for display case and linear accent lighting. With the dedicated InteGrade connectors it is easy to create longer lightlines. Thanks to the system's compact dimensions, it can be aesthetically integrated into the store interior.

The unique asymmetrical optics direct the light to where you want it, thus making optimum use of the light and energy. The products or background you want lit will be presented uniformly, while reducing glare and dark spots. Our LEDs have minimal output degradation and color shift, so the light remains consistent throughout their long service life. InteGrade LED is, quite simply, an ideal solution for high-quality lighting without flicker or color differences. Mounting accessories, cables and LED power driver are available separately.

Benefits for the end users

- Energy savings of up to 65%¹
- Superb asymmetrical optics
- InteGrade cabling allows connection to own connector system
- InteGrade LED system in combination with Philips cables and Philips Advance Xitanium power driver and dimming protocols

Applications include:

- Display case lighting:
 - Retail (refrigerated and ambient temperature)
 - Hospitality



Philips InteGrade LED Fixture System

The InteGrade LED fixture system is a pre-assembled fixture in 34" and 46". The fixture consists of a profile and InteGrade engines (combination of 6" & 23" module) and inline locks.

Benefits for the end users

- Energy savings of up to 65%¹
- Superb asymmetrical optics
- InteGrade cabling allows connection to own connector system
- InteGrade LED system in combination with Philips cables and Philips Advance LED power driver

Applications include:

- Display case lighting:
 - Retail (refrigerated and ambient temperature)
 - Hospitality

For more driver information, visit www.philips.com/ledmodulesna or contact your local Philips sales representative.

1. When comparing energy consumption of two InteGrade engine value 575mm (23") 830 with a Philips 28W T5 lamp (28W).

Atlas catalog
.....
LED modules
.....

Notes



Electronic Fluorescent Ballasts

General information	3-1
Compact fluorescent lamps	3-22
CFL	3-22
2D	3-25
Long Twin Tubes	3-27
Linear fluorescent lamps	3-30
T5	3-30
T5 and T5HO Circline	3-32
T5HO	3-33
T8	3-39
T8 Slimline	3-59
T8HO	3-60
T12	3-61
T12 Slimline	3-62
T12HO	3-63
Sign ballasts	3-64
Specialty fluorescent lamps	3-67
UV disinfection	3-67
Refrigeration	3-68

Corporate Offices
(800) 322-2086

Customer Support/Technical Service
(800) 372-3331 • (+) 1 847 390-5000 (International)

Visit our web site at www.philips.com/oemna.

Note: Refer to page 9-7 to 9-16 for Ballast Specifications.

Fluorescent Ballasts - Electronic - Centium

Electronics Ballasts for T5, T8, T12 and Long Twin Tube Fluorescent Lamps

Reliable and robust, this broad line of Centium high frequency electronic ballasts for T5, T5HO, T8 and T12 fluorescent lamps offers all of the necessary commercial grade specifications plus the added benefits of lamp striation reduction technology making these ballasts compatible with energy saving T8 lamps. This provides your customers with a better energy saving solution than when using standard T8 ballast.

Our Centium ballasts are an optimal choice for a broad range of new construction and retrofit applications within the commercial sector, including general office lighting, conference, meeting and board room applications, indirect and decorative lighting and new fixture designs requiring smaller ballasts.



Fluorescent Ballasts - Electronic - Optanium

High-efficiency electronic ballasts for a broad range of T5 and T8 lamps

Optanium ballasts for T5 and T8 lamps are part of our effort to promote environmental responsibility through energy efficient products, lighting systems, services and expertise through Philips Advance branded products. These ballasts are part of an overall high-efficiency lighting system that can help you achieve LEED certification, meet ASHRAE standards and become compliant with California Title 24 Energy Efficiency Standards or any other local energy code applicable to you or your customers.

Optanium ballasts will help you and your customers meet a variety of application challenges, including luminaire design, installation, maintenance and evolving lamp technology. Optanium ballasts are available in standard light output, low-watt and high light output designs. Also these ballasts come in options with cold-starting capability down to -20°F (with standard fluorescent lamps). These two features combined make them ideal for just about any T5 or T8 fixture design and application. These ballasts are available in either instant start or programmed start ignition for extended lamp life in frequent switching applications such as those where occupancy sensors or motion detectors are being used. Optanium ballasts are also available in program start with parallel wiring.

Striation-reduction technology

Reduces the likelihood of striation often associated with energy-saving lamps for consistent light output

Cold temperature lamp ignition down to -20°F for instant or program start ballasts

Brings energy-efficient T5 and T8 performance to a variety of new applications such as parking garages, warehouses and cold storage areas

Arc-reduction technology — UL Type CC

UL Type CC* (on certain ballasts)

Program Start Parallel (PSP)

Program start ballasts with parallel wiring deliver independent lamp operation preventing premature lamp shut down ultimately reducing maintenance

High efficiency design

Helps maximize energy savings with improved ballast efficiency

* When operating standard non-energy saving lamps



Fluorescent Ballasts - Electronic - SmartMate

Electronic Ballasts for 4-Pin Compact Fluorescent Lamps

Offering maximum versatility, the Philips Advance family of SmartMate electronic ballasts for 4-pin compact fluorescent lamps drive a broad range of quad and triple-tube, circline, 2D and long twin-tube lamps. Representing an innovative breakthrough in CFL ballast technology, SmartMate ballasts' energy-efficient design, compact and lightweight housing and user-friendly features make SmartMate ballasts an ideal choice for fixture manufacturers, retrofitters and MRO replacement.

SmartMate ballasts are ideal in such applications as restaurants, reception areas, conference and meeting rooms, hotel and convention center ballrooms and houses of worship, as well as in place of incandescent downlighting systems.

We also offer our distribution partners a way to eliminate the need to stock loose components with SmartMate Ballast Replacement Kits.

Conveniently packaged, these kits come complete with a Philips Advance SmartMate ballast, a mounting plate adaptor, lead wire and a wire extraction tool for the ultimate in ease and versatility. See page 3-21 for details on kits.

Dual-entry connector

Reduces SKU requirements and inventory costs, as unit can be used with side or bottom exit leads

Color-coded, poke-in terminals

Enhances wiring accuracy and ease of assembly/installation

Operation between 42kHz and 52kHz

Eliminates interference with infrared systems, anti-theft devices or other electronic equipment

Lamp End-of-Life Protection Circuit

Removes power to lamps upon lamp failure



Fluorescent Ballasts - Electronic - AmbiStar

Residential Ballasts for 4-pin CFL, T8 or T12 Lamps

Today's fixed and dimmable fluorescent fixtures offer greater flexibility and energy savings for residential and hospitality settings than ever before, thanks to Philips Advance AmbiStar electronic ballasts. No matter what type of fluorescent lighting you're considering, these ballasts help create warm, inviting interiors while providing Class B FCC EMI Rating – a requirement for the ENERGY STAR Luminaires Specification.

AmbiStar ballasts feature sleek, compact designs to fit in today's stylish fixtures. AmbiStar ballasts deliver quiet, flicker-free performance, which makes them perfect for any residential or hospitality setting.

Class B FCC EMI Rating

Requirement for ENERGY STAR Luminaires Specification for fixtures

Title 24 Energy Efficiency Requirements

Enables California's Title 24 Residential Lighting Energy Efficiency standards with applicable luminaire design

Electronic circuitry

Enable ballast to run cooler and operate quieter than many magnetic ballast alternatives

Fast start times

Flicker-free ignition starts in less than 1.0 seconds, meeting EPA ENERGY STAR Requirements for Residential Lighting Fixtures



Fluorescent Ballasts - Electronic - signPRO

Electronic Sign Ballasts for T8/HO and T12/HO High Output (800mA) Lamps

Philips Advance signPRO line, a brand synonymous with full-line, high-quality sign ballasts offered exclusively to the sign industry to support the market's broad range of sign applications, now add signPRO Electronic Fluorescent Sign Ballasts.

These ballasts support over 200 different fluorescent lamp combination from the convenience of just four energy-efficient and easy-to-use models.

Microprocessor-controlled design

Enables one ballast to operate multiple lamps

IntelliVolt multiple-voltage technology enables operation from 120 to 277V, 50/60Hz

Enhances accuracy of ordering and reduces SKU requirements

Lamp End-of-Life Protection Circuit

Removes power to lamps upon lamp failure

Auto-Restart

Eliminates the need to reset power mains after lamp replacement

Instant-Start, parallel lamp operation

Designed so that if one lamp fails, other lamps remain lit



Fluorescent Ballasts - Electronic - PureVOLT

Electronic Ballasts for High Output (HO) Germicidal Ultraviolet (UV) Lamps

In support of the growing popularity of High Output (HO) germicidal UV-C lamps – which have been effective at improving indoor air quality in low temperature environments such as HVAC systems – Philips Advance PureVOLT electronic UV ballast is specially designed to operate a variety of 800mA HO UV lamps. PureVOLT is ideal in such applications as hospitals, food processing facilities, schools, office buildings, recreational facilities and residences.

Microprocessor-controlled design

Enables one UV ballast to operate multiple lamps

IntelliVolt multiple-voltage technology enables operation from 120 to 277V, 50/60 Hz

Enhances accuracy of ordering and reduces SKU requirements

Lamp End-of-Life Protection Circuit

Removes power to the lamp upon lamp failure

Auto-restart

Eliminates the need to reset power mains after lamp replacement

Programmed-start technology

Provides extended lamp life in frequent switching applications



Electronic Ballast Fundamentals

The Job of a Ballast

In all fluorescent lighting systems, the ballast's basic tasks include:

- Providing the proper voltage to establish an arc between the two electrodes.
- Regulating the electric current flowing through the lamp to stabilize light output.

In some fluorescent lighting systems, the ballast also provides a controlled amount of electrical energy to preheat or maintain the temperature of the lamp electrodes at levels specified by the manufacturer. This is required to prevent electrode filaments deteriorating prematurely and shortening the lamp life.

Starting Methods

For many years there were only three types of lighting systems: preheat, rapid start and slimline instant start. With the introduction of electronic ballasts, two additional types of lighting system circuits have been added: instant start and programmed start for T8 lamps. Each requires a special ballast design to operate the lamps in the circuit properly.

Instant start electronic ballasts start lamps without delay (<0.1 second) or flicker by providing a starting voltage that is sufficiently high to start a discharge through the lamps without the need for heating lamp electrodes. For F32T8 systems, the starting voltage is about 600V. The elimination of electrode heating helps maximize energy savings — typically saving 2W per lamp compared to rapid start ballasts¹. Instant start ballasts are best suited for applications with limited switches each day. Lamps operated by instant start ballasts typically operate 10,000 to 15,000 switch cycles before failure.

Rapid start electronic ballasts start lamps quickly (0.5 – 1.0 second) without flicker by heating the lamp electrodes and simultaneously applying a starting voltage. The starting voltage of about 500V for F32T8 systems is sufficient to start a discharge through the lamps when the electrodes have reached an adequate temperature. Electrode heating continues during operation and typically consumes 2W per lamp. Lamps operated by rapid start ballasts typically operate 15,000 to 20,000 switch cycles before failure.

Programmed start electronic ballasts also start lamps quickly (1.0 -1.5 seconds) without flicker. Programmed start ballasts are designed to maximize lamp life in frequent lamp starting applications such as in areas where occupancy sensor controls are used. Programmed start electronic ballasts precisely heat the lamp electrodes, tightly controlling the preheat duration before applying the starting voltage. This enhancement over rapid start ballasts helps minimize electrode stress and depletion of emitter material, thereby maximizing lamp life. Lamps operated by programmed start ballasts typically operate up to 100,000 switch cycles before failure.

Circuits

Series vs. Parallel. Lighting systems are typically wired in a series or parallel circuit. When a ballast is operating multiple lamps in a series circuit, if one lamp fails, the circuit is opened and all the lamps will extinguish. When a ballast operates multiple lamps in a parallel circuit, the lamps operate independently of each other so, if one lamp fails, the others can keep operating as the circuit between them and the ballast remains unbroken.

The Language of Ballasts

Input Voltage (dedicated vs. multi). Most ballasts are designed to operate at specific voltages. Newer electronic ballasts, including Philips Advance models that use IntelliVolt technology, offer much greater flexibility and other advantages such as inventory reduction. Today's increasing demands on electrical utilities can cause wide voltage variations during load demand changes, which in turn cause light output from lamps operated on dedicated electronic and electromagnetic ballasts to vary with the input voltage changes. With IntelliVolt technology, many Philips Advance ballasts maintain constant light output through nominal input voltage ranges of 120 to 277 volts, thereby compensating for any change in input voltage. Some ballasts operate from 277 to 480 volts or 347 to 480 volts.

Input Watts/ANSI Watts. Input watts published by ballast manufacturers are the total watts consumed by both the ballast and the lamps it operates. ANSI watts are the rating given for a ballast measured under the strict testing procedures specified by ANSI standards and are a dependable measure of this lamp/ballast performance. Energy savings can be determined by comparing the input watts of different lighting systems.

Input watts may be affected by tolerance build-up from the ballast, lamp, input voltage and ambient temperature. The input watts published in this catalog are for nominal conditions only.

Ballast Factor (BF) is the ratio of light output from a lamp operated on a commercial ballast to the light output of that same lamp operated on a "reference ballast" as specified by ANSI standards. Light output ratings published by lamp manufacturers are based on this "reference ballast."

$$BF = \frac{\text{light output of lamp operated on commercial ballast}}{\text{light output of lamp operated on reference ballast}}$$

Ballast Efficacy Factor (BEF) is the ratio of ballast factor to input watts. This measurement is generally used to compare the efficiency of various lighting systems — higher numbers being more efficient.

$$\text{Ballast Efficacy Factor} = \frac{\text{Ballast Factor} \times 100}{\text{Input Watts}}$$

This comparison is only valid, however, for ballasts operating the same number and type of lamps. In order to compare different types of lighting systems, the lumen output of the lamps must also be used.

Ballast Luminous Efficiency (BLE) is the ratio of total lamp arc power to input watts. This metric, new in 2014, is based solely on electrical measurements.

$$BLE = \frac{\text{Total Lamp Arc Power}}{\text{Input Watts}}$$

See footnote on page 3-69.

Power Factor (PF) is the measurement of how effectively a ballast converts the voltage and current supplied by the power source into watts of usable power delivered to the ballast and lamps. Perfect power utilization would result in a power factor of one.

$$PF = \frac{\text{Input Watts}}{\text{Input Current} \times \text{Input Voltage}}$$

A ballast's power factor may be classified under any one of the following categories:

High Power Factor (HPF)	0.90 or greater
Power Factor Corrected (PFC)	0.80 to 0.89
Normal (Low) Power Factor (NPF)	0.79 or less

Power factor measurements pertain only to the effective use of power supplied to the ballast. They are not an indication of the ballast's ability to supply light through the lamps. Because low power factor ballasts require about twice the current needed by high power factor ballasts, they allow fewer fixtures per circuit and create added wiring costs. High power factor ballasts are generally specified for all commercial lighting applications.

EMI/RFI. Because they operate at high frequency, electronic ballasts may produce electromagnetic interference (EMI) or radio frequency interference (RFI). RFI frequencies are a subset of EMI frequencies. EMI issues cover all possible operating frequencies while RFI is only concerned with radio and television frequencies. This interference could affect the operation of sensitive electrical equipment, such as radios, televisions or medical equipment. All Philips Advance electronic ballasts incorporate features necessary to afford maximum protection for the operating environment and operate well within regulatory limits.

Ballast Noise. The slight "humming" sound associated with fluorescent lighting systems results from vibration caused by the inherent electromagnetic action in the core-and-coil assembly of the ballasts. All electromagnetic and some electronic ballasts make this sound. Ballasts are assigned a sound rating, "A" through "F", based on the amount of sound produced, with "A" being the quietest. Generally, the larger the lamp and ballast, the higher the sound level and the sound rating will be. Because electronic ballasts have smaller components, they have the lowest sound rating. Some electronic ballasts make almost no sound. There is no ANSI standard for this rating, and it is left up to the manufacturer to rate their ballasts.

Inrush Current. All electrical devices including ballasts have an initial current surge that is greater than their steady-state operating current. A standard published by the National Electrical Manufacturers Association (NEMA) — NEMA 410 — Performance Testing for Lighting Controls and Switching Devices with Electronic Fluorescent Ballasts — covers worst-case ballast inrush currents. All circuit breakers and light switches are designed for inrush currents. The electrical system should be designed with this issue in mind.

Total Harmonic Distortion (THD). Harmonic distortion occurs when the wave-shape of current or voltage varies from a pure sine wave. Except for a simple resistor, all electronic devices, including electromagnetic and electronic ballasts, contribute to power-line distortion. For ballasts, THD is generally considered the percent of harmonic current the ballast adds to the power distribution system. The ANSI standard for electronic ballasts specifies a maximum THD of 32% for commercial applications. However, most electric utilities now require that the THD of electronic ballasts be 20% or less. Almost all Philips Advance electronic ballasts are rated for either less than 20% THD or less than 10% THD.

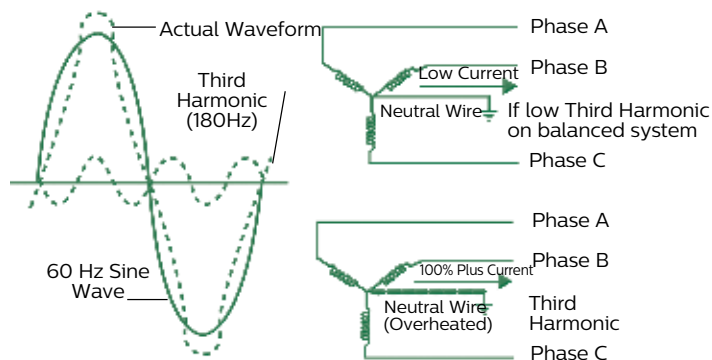

 Indicates ballast is listed with Underwriters Laboratories, Inc. and complies with UL935 Standard for Fluorescent Lamp Ballasts (File No. E14927).

Visit www.ul.com to find a current listing of Philips Advance ballasts under File No. E14927.

 Indicates ballast is certified by Canadian Standards Association and complies with CSA C22.2 No. 74 Standard for Fluorescent Lamp Ballasts (File No. 007310).

Visit www.csa-international.org to find current listing of Philips Advance ballasts under File No. 007310.

Normal Input Voltage	Catalog Number Prefix Code	Label Color Coding
120V	R	Yellow
277V	V	Red
347V	G	Grey
120V to 277V	I	Blue
347V to 480V	H	Purple

 Indicates ballast complies with directive 2002/95/EC Restriction of Hazardous Substances.

Total Harmonic Current

Non-Dimming Applications

When selecting a ballast for a lighting application, the Total Harmonic Current (THC) rating of the ballast is more significant than Total Harmonic Distortion (THD). This is because the absolute value of harmonic current, not the percentage, affects the electrical power distribution system. As can be seen in the table below, the THC rating of our Standard 2-lamp electronic T8 lamp ballast (REL-2P32-SC) is well below that of both the conventional (RQM-2S40-TP) and energy-saving magnetic T12 lamp ballasts (R-2S40-TP) it replaces. Moreover, the THC rating of our Centium electronic ballast is even lower.

Dimming Applications

Mark 70-10V and ROVR

Traditional low voltage controlled ballasts and ROVR typically produce less than 10% THD at full light output and less than 20% THD throughout the entire dimming range but require extra wires for the control circuit. THC is lower than that of the conventional or energy-saving magnetic system.

Mark 10 Powerline

Mark 10 *Powerline* electronic dimming ballasts are controlled by 2-wire modified powerline phase-cut style line voltage dimmers. Whenever the ballast is dimmed, the input voltage is cut or “chopped,” causing the THD to increase and the Power Factor to decrease.

Mark 10 *Powerline* electronic dimming systems (ballast and controller) have similar THD and Power Factor levels as the

conventional lighting systems they replace. Since a much smaller load is required by the Mark 10 *Powerline* electronic dimming system to achieve the same illumination level as a magnetic ballast system (20-30% less), the total input current will be considerably less. As a result, the magnitude of the total harmonic current will be less.

For example, a typical Mark 10 *Powerline* electronic ballast and dimmer control might draw a line current of 0.58A at 15% THD at full light output. If the light level is reduced to 5% of the maximum, the input power is decreased to 0.19A at 95% THD. While the THD level may seem high at the 5% maximum light output setting, the total harmonic current is still lower (0.13A) than the conventional T12 magnetic system (0.20A). Moreover, the overall heating effect on the wires and the distribution transformer is not higher than the existing conventional or energy saving T12 magnetic systems.¹

Conclusions

A simple ballast retrofit to electronic ballasts should not cause harmonic problems if none existed before the retrofit. Also, in new fixture applications, total harmonic distortion should not be a concern when specifying electronic ballasts. Finally, it is important to remember that electronic ballasts are not the greatest source of THD in an electrical distribution system. Other electronic devices such as computers, laser printers and other electronic equipment can draw current with more than 100% THD in some cases.

Table 1: Comparison of THD and THC Levels

Philips Advance Part No.	Ballast Type	Light Output Setting	Lamp Type	Input Current	% THD	THC ²
RQM-2S40-TP	Conventional Magnetic	100% (Ballast Factor is 0.98)	(2) F40T12	0.84A	<25%	0.20A
R2S40-TP	Energy Saving Magnetic	100% (Ballast Factor is 0.95)	(2) F34T12	0.63A	<20%	0.12A
REL-2P32-SC	Standard Electronic	100% (Ballast Factor is 0.88)	(2) F32T8	0.49A	<20%	0.10A
ICN-2P32-N	Centium Electronic	100% (Ballast Factor is 0.88)	(2) F32T8	0.49A	<10%	0.05A
IZT-2S32-SC + Dimming Control	Mark 70-10V Electronic	100% (Ballast Factor is 1.0)	(2) F32T8	0.57A	<10%	0.05A
IZT-2S32-SC + Dimming Control	Mark 70-10V Electronic	5% (Ballast Factor is 0.05)	(2) F32T8	0.12A	<20%	0.02A
REZ-2S32-SC (Ballast Only)	Mark 10 Powerline Electronic	100% (Ballast Factor is 1.0)	(2) F32T8	0.58A	<10%	0.06A
REZ-2S32-SC + Dimming Control	Mark 10 Powerline Ballast + Dimmer	100% (Ballast Factor is 1.0)	(2) F32T8	0.58A	<15%	0.09A
REZ-2S32-SC + Dimming Control	Mark 10 Powerline Ballast + Dimmer	5% (Ballast Factor is 0.05)	(2) F32T8	0.19A	<95%	0.13A

¹ For a more technical study comparing the a Mark 10 *Powerline* electronic dimming system to an energy saving magnetic system that it replaces, see the article Total Harmonic Distortion in Philips Advance Mark 10 *Powerline* Electronic Dimming Systems by O.C. Morse.

² The Total Harmonic Current (THC) of a ballast is calculated by the following equation: An approximation of THC may be obtained by simply multiplying the ballast input current by %THD.

$$\frac{\text{Ballast Input Current}}{\text{Square Root of } (1 + 1/\text{THD}^2)}$$

Ballast Life

Philips Advance fluorescent electronic and magnetic ballasts are designed and manufactured to engineering standards correlating to an average life expectancy of 50,000 hours of operation at maximum rated case temperature². Since Philips Advance ballasts operate below their maximum case temperature in the majority of applications, increased ballast life can be expected. As a rule of thumb, ballast life may be doubled for every 10°C reduction in ballast case operating temperature. However, there are many variables, such as input voltage, ambient temperature, etc., that affect ballast operating temperatures and therefore ballast life.

Lamp Operating Frequency

Electromagnetic ballasts and the lamps connected to them operate at an input voltage frequency of 60 Hertz (Hz), 60 cycles per second — which is the standard alternating voltage/current frequency provided in North America. Electronic ballasts, on the other hand, convert this 60 Hz input to operate lamps at much higher frequencies above 20 Kilohertz (kHz), 20,000 cycles per second. Philips Advance ballasts operate above 20 kHz but avoid certain ranges such as 30–40 kHz (infrared) and 54–62 kHz (theft deterrent systems) due to interference issues.

Because electronic ballasts function at high frequency, the fluorescent lighting systems that they operate can convert power to light more efficiently than systems operated by electromagnetic ballasts (see chart below). For example, lamps operated on electronic ballasts can produce over 10 percent more light than if operated on electromagnetic ballasts at the same power levels. In effect, today's electronic ballasts provide additional energy savings by matching the light output from electromagnetic ballasts while operating the lamps at lower power. This is the main reason why electronic ballast systems are more efficient than magnetic ballast system.

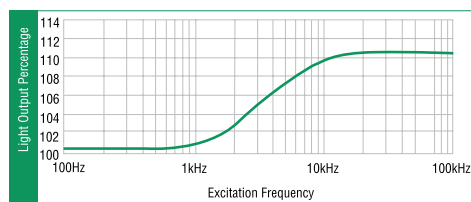

Crest Factor

Lamp manufacturers use crest factor to determine ballast performance as it relates to lamp life. Lamp Current Crest Factor is a measurement of current supplied by a ballast to start and operate the lamp. It is basically the ratio of peak current to RMS (average) current. High crest factor currents may cause the lamp electrodes to wear out faster, reducing lamp life. Crest factor requirements are regulated by ANSI (American National Standards Institute) standards and specified by lamp manufacturers. For rapid start and instant start T8 lamps the ratio is 1.7 maximum, and for instant start slimline lamps, it is 1.85 maximum.

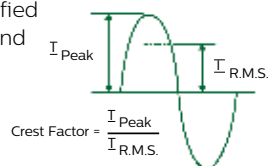

Weight and Size Advantages

Since electronic components in electronic ballasts are smaller and lighter than the core-and-coil assembly in electromagnetic ballasts, electronic ballasts can weigh less than half as much as comparable electromagnetic models. Almost all Philips Advance electronic ballasts have a smaller cross-section than

electromagnetic ballasts but maintain the same mounting dimensions. This means that they can fit into all new fixture designs and can be easily retrofitted into existing fluorescent lighting systems.

Controllability

The ability of a building's occupants to control how they light their space is becoming an increasingly important factor for organizations in determining what real estate they will lease, buy or invest in. The ability to dim the lights or easily shut them off completely is a trend fueled not just by a desire to help the environment, but also by significant economic benefits. These benefits include greater energy efficiency — in terms of reduced HVAC costs as well as energy savings for lighting — more comfortable and productive working environments and compliance with ever tighter energy efficiency regulations. Philips Advance offers four families of electronic controllable ballasts — ROVR, Mark 7 0-10V, Mark 10 *Powerline* and *PowerSpec* HDF.

Compatibility With Powerline Carrier Systems

A powerline carrier system (PLC) uses electronic wiring devices to send information via a high frequency signal over the 120V or 277V electrical power distribution system of a building. For example, PLC systems are used in automatic clock systems (master time systems) to synchronize all of the clocks in a building or reset the time after a power outage. They eliminate the need for maintenance personnel to reset hundreds of clocks throughout a facility.

In a PLC system, a generator is used to impose a 1 to 4V high frequency signal on top of the existing voltage sine wave (60 Hz). This signal is generally in the 2500 to 9500Hz range, with some older systems operating at 19,500Hz or higher. Some electronic ballasts that are capacitive can absorb the signal from a PLC system. As a result, the signal becomes too weak to be “heard” by the receiver (like a timeclock) connected to the powerline.

Instant Start vs. Rapid Start Sockets for Dimming

When using dimming ballasts in fixtures, sockets must be of the Rapid Start type. Many fixtures with T-8 Instant Start electronic ballasts use jumpered or “shunted” Instant Start sockets. Controllable ballasts require two distinctly separate wires for each lamp socket. If you encounter shunted or jumpered sockets in a retrofit application, they must be removed and replaced with Rapid Start sockets.

Improper socket application will damage the ballast and void the ballast warranty. Refer to ballast wiring diagram for proper installation.

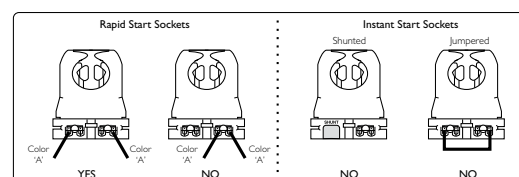

Fluorescent Lamp Burn-In

Today, most lamp manufacturers do not require the burn-in of linear fluorescent lamps prior to dimming in order to attain rated lamp life and stable electrical measurements. However, some manufacturers of compact fluorescent lamp sources do require a 100-hour burn-in prior to dimming. Consult your lamp manufacturer for their latest requirements.

See footnote on page 3-69.

Ordering Information

How to Order

Philips Lighting has developed the industry's broadest distribution system for electronic ballasts – more than 3000 stocking distributors nationwide. For information on the distributor best able to serve your needs, please call 800-372-3331.

Electronic Ballast Part Number Breakdown

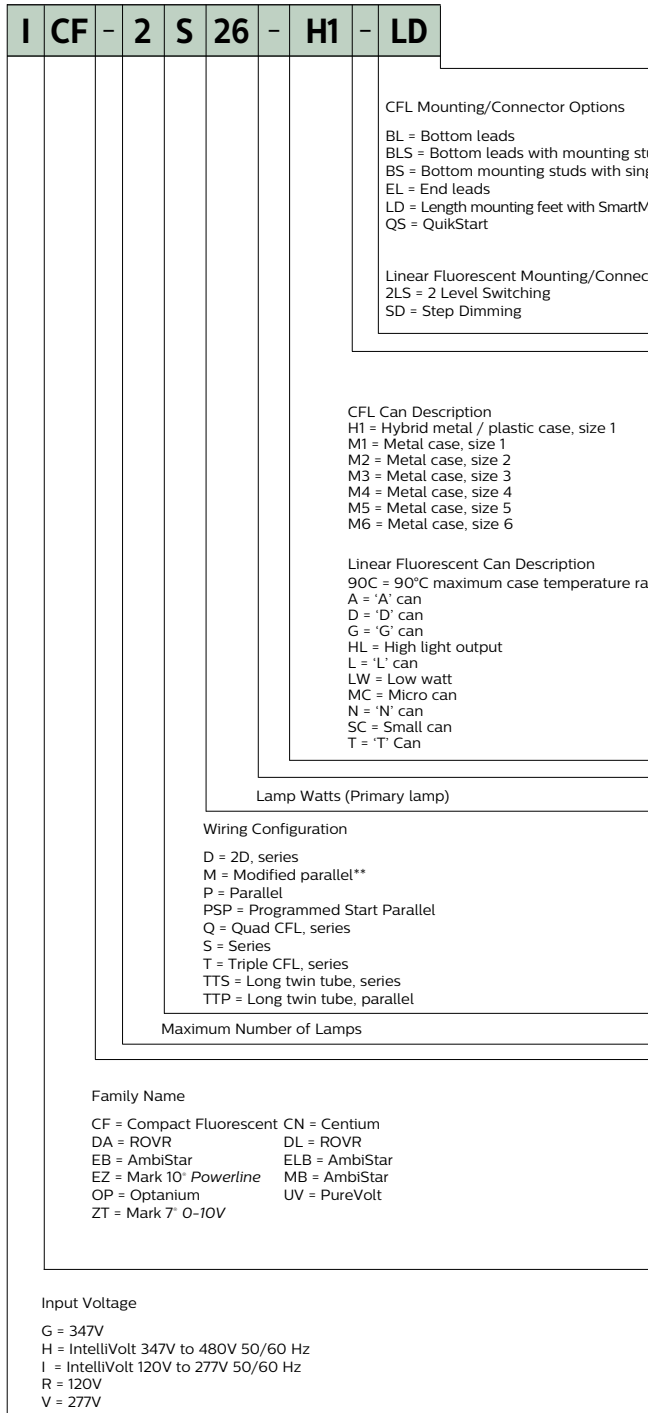

Corporate Offices
 (800) 322-2086

Customer Support/Technical Service
 (800) 372-3331
 (+) 1 847 390-5000 (International)

Visit our web site at
www.philips.com/oemna.

- Plan your lighting installation carefully; consider using the services of a qualified lighting designer.
- Consult your local electric utility regarding demand side management rebate programs.
- Select the Philips Advance electronic ballast that best matches the requirements of your application. The technical specifications in this catalog (located on pages 9-7 to 9-16) will be useful in obtaining bids from electrical contractors.
- Contact your local Philips Lighting distributor. You will find them to be a helpful supplier of both products and information.

* Many current and all future electronic ballast part numbers will not use the "RH-TP" suffixes even though these ballasts will be thermally protected.
 ** Parallel Wiring Configuration. However, if one lamp fails, all other lamps in the circuit will extinguish.

Remote, Tandem or Through Wiring Distances

Remote Mounting of Electronic Ballasts

Unlike magnetic ballasts, electronic ballasts are limited in remote mounting distance from the lamps they operate. The factors limiting the distance from the electronic ballasts to the lamps are: open circuit voltage as opposed to operating voltage, operating frequency and the lamp operating current.

As the distance from the high frequency electronic ballasts to the lamp increases, so does the capacitance across the lead wire to the lamp. This increase in capacitance is important for two reasons. First, if the capacitance is too high, there will not be sufficient open circuit voltage across the lamp for proper lamp ignition.

Second, if the lamp is capable of ignition, the increased capacitance will cause a loss in the current to the lamp. The added capacitance creates what is known as a “shunt” around the lamp. In other words the current will leak from the red wire (or blue) to the yellow, completely bypassing the lamp. The current through the lamp will be reduced, resulting in lower lumens, with the possibility that the lamp will not be capable of sustained operation.

The Mark 7 0-10V, Mark 10 *Powerline* and ROVR dimming ballasts are particularly sensitive to high capacitance associated with long lead wires. The dimming ballast is capable of very low dim levels because constant filament heat is provided to the lamp. If there is any loss of current, the filament current will be reduced and the lamp will begin to flicker, or it will be completely extinguished. It is also important that the red and blue leads not be twisted together. Twisting the red and blue leads will add capacitance, causing the lamp to flicker at the lower dimming levels.

Open circuit voltage is a function of input voltage in some ballast designs, particularly for dedicated voltage ballasts. Cold temperature starting is a function of open circuit voltage. The lead length recommendations in the following table are for normal rated input voltages (120V, 277V, 347V) at 25°C ambient temperature.

In summary, there is a wide range and varying types of electronic ballast architectures that are capable of being remote mounted for an equally wide range of distances. If you are uncertain of the remote mounting restrictions for a particular electronic ballast please consult Philips Lighting Customer Care (Warranty/ Technical Service).

Remote Wiring

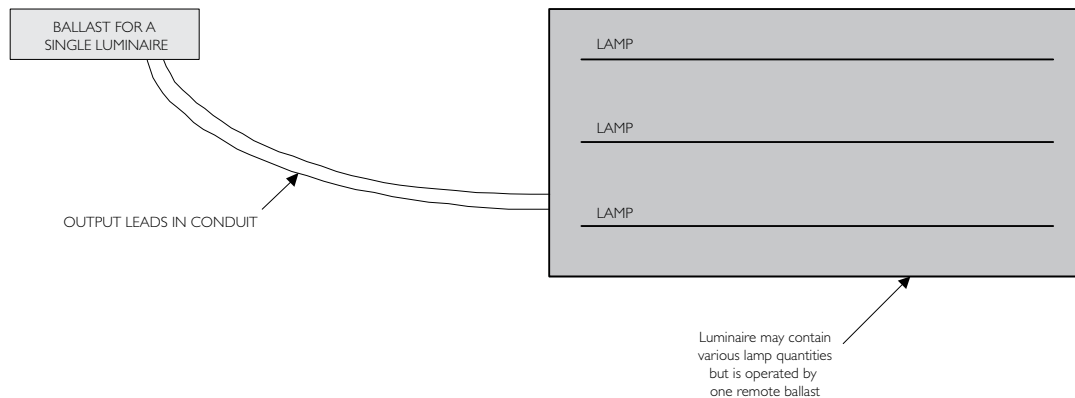

Note: Recommended output lead lengths and remote mounting distances should not be exceeded.

Tandem Wiring

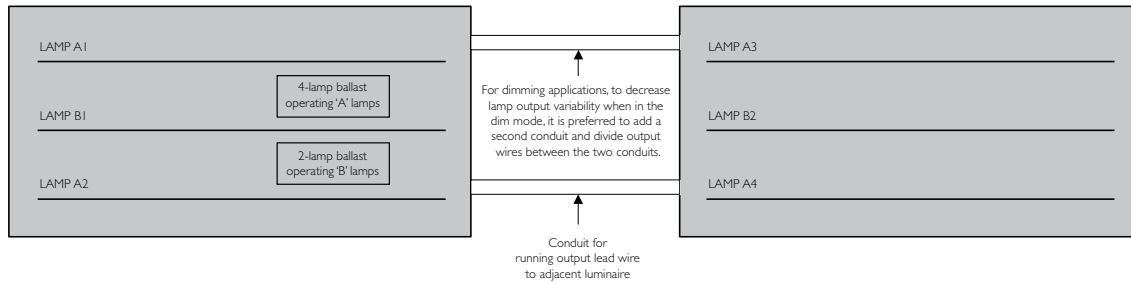

2 BALLAST EXAMPLE

BALLAST 'A' OPERATES OUTBOARD LAMPS
 BALLAST 'B' OPERATES INBOARD LAMPS

(2) 3-lamp luminaires shown as an example, but this would also be applicable for any luminaire containing 2 lamps or more.

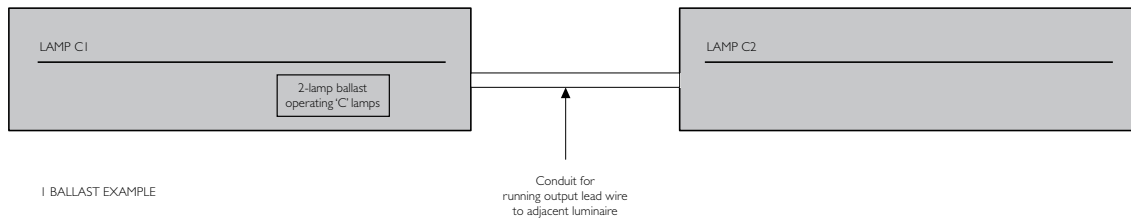

1 BALLAST EXAMPLE

Through Wiring

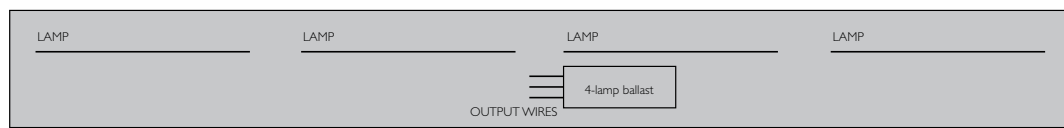

4 - LAMP BALLAST

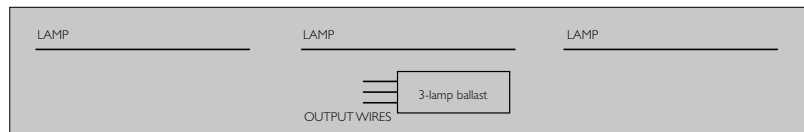

3 - LAMP BALLAST

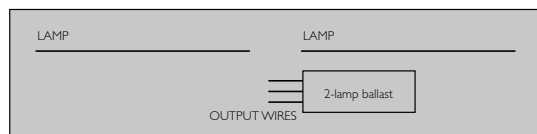

2 - LAMP BALLAST

Note: Ballast should be mounted at center of fixture to minimize lead lengths. Recommended output lead lengths and remote mounting distances (pages 3-15 to 3-19) should not be exceeded.

Diagrams are also applicable for multiple lamp cross-section luminaires. For example, an 8-foot luminaire with two lamps in cross section and a single 4-lamp ballast.

Philips Fluorescent Dimming Ballast Application Usage

- While installing a Philips fluorescent dimming ballast in a fixture, care should be taken that the output lead lengths do not exceed the specified maximum permissible limits. These limits are specified in the Remote, Tandem or Through Wiring Distance table on the next page.
- If excessive output lead lengths (outside the specification) are maintained for a Philips fluorescent dimming ballast the ballast may behave undesirably or abnormally at low dim levels.
- If output lead wire lengths are not specified for linear Philips fluorescent dimming ballasts, then it implies that the output lead length should not be extended any more than what was provided with the dimming ballast.
- For Philips CFL dimming ballasts, the output lead length between the ballast and the lamp socket should be maintained as short as possible. It is recommended that this lead length should not exceed 24".
- Before using a Philips fluorescent dimming ballast in remote mounting applications or for applications with emergency power supplies, please refer to the Remote, Tandem or Through Wiring Distance table on the next page and verify whether the ballast supports remote mounting application.
- If the Philips fluorescent dimming ballast supports remote mounting, then
 - For non-emergency application, the remote mounting distance should not exceed the specified limit.
 - For applications with emergency power supplies, the total output lead wire length measured from the fluorescent dimming ballast to the lamps sockets (including the emergency ballast wiring) should not exceed the specified limit of the Remote, Tandem or Through Wiring Distance table on the next page.
- If the Philips fluorescent dimming ballast does not support remote mounting, then
 - For non-emergency application, the output lead length should not be extended any further than what was provided with the dimming ballast.
 - For applications with emergency power supplies, the total output lead wire length measured from the dimming ballast to the lamp sockets (including the emergency ballast wiring) should not exceed the lead length that was provided with the fluorescent dimming ballast. If maintaining the lead lengths within the specification is not possible, then it is recommended to use a Philips fluorescent dimming ballast that supports remote mounting. The example in the next column can be used as a reference for an appropriate application usage of a Philips fluorescent dimming ballast.

Example:

A luminaire contains (1) IZT3PSP32SC Philips Mark 7 0-10V fluorescent dimming ballast and (1) emergency ballast in a three lamp, single lamp cross-section, 12' fixture. This application will have issues because of the excessive wire lengths that result in capacitive losses which may cause short lamp life, uneven lamp performance or even inability to ignite the lamp(s). In such an application it is preferred to use one of the following approaches:

- * One IZT2PSP32SC ballast to control two lamps (can be remote mounted up to 6') and one IZT132SC ballast in conjunction with the emergency ballast to control one lamp. The total output lead length measured from the dimming ballast to the lamps sockets (including the emergency ballast wiring) should be less than 6'.
 - * One IZT132SC ballast to control one lamp (can be remote mounted up to 6') and one IZT2PSP32SC ballast in conjunction with emergency ballast to control two lamps. The total output lead length measured from the dimming ballast to the lamps sockets (including the emergency ballast wiring) should be less than 6' (This approach will provide 2 lamps to be turned ON during emergency).
- For additional application support, contact technical support at Philips Lighting.

	Allowed Wiring Configuration			Maximum Lead Length (Feet) for Tandem or Through Wiring (Total length of all wires between ballast and lamp sockets)						Application Note
	Remote (max length)	Tandem	Through	Blue	Red	Yellow	Blue/ White	Brown	Orange	
GCN-2S28-L	20'	Yes	Yes	10'	10'	10'				2 (f)
GOP-2PSP32-LW-SC	20'	Yes	Yes	20'	20'	18'				1 (e)
GOP-2PSP32-SC	20'	Yes	Yes	20'	20'	18'				1 (e)
GOP-3PSP32-SC	20'	Yes	Yes	20'	20'	18'	18'			1 (e)
GOP-4PSP32-LW-SC	20'	Yes	Yes	20'	20'	18'	18'	18'		1 (e)
GOP-4PSP32-SC	20'	Yes	Yes	20'	20'	18'	18'	18'		1 (e)
GOPA-1P32-LW-SC	8'	Yes	Yes	8'	8'					1 (c)
GOPA-1P32-SC	8'	Yes	Yes	8'	8'					1 (c)
GOPA-2P32-LW-SC	8'	Yes	Yes	8'	8'					1 (c)
GOPA-2P32-SC	8'	Yes	Yes	8'	8'					1 (c)
GOPA-3P32-LW-SC	8'	Yes	Yes	8'	8'					1 (c)
GOPA-3P32-SC	8'	Yes	Yes	8'	8'					1 (c)
GOPA-4P32-LW-SC	8'	Yes	Yes	8'	8'	8'				1 (c)
GOPA-4P32-SC	8'	Yes	Yes	8'	8'	8'				1 (c)
GZT-2S32-SC	6'	Yes	Yes	6'	6'	6'				1
GZT-3S32-SC	No	No	No							5
HCN-2S54-90C-WL	20'	Yes	Yes	20'	4'	20'				3
HCN-4S54-90C-2LS-G	20'	Yes	Yes	20'	4'	4'	20'	20'	20'	7
HOP-2PSP32-HL-L	20'	Yes	Yes	20'	20'	18'				1 (e)
HOP-2PSP54-L	20'	Yes	Yes	20'	20'	15'				1
HOP-4PSP32-HL-G	20'	Yes	Yes	20'	20'	18'	18'	18'		1 (e)
HOP-4PSP54-2LS-G	20'	Yes	Yes	20'	20'	15'	15'	15'		1
ICF-1D38-H1-LD	15'	NA	NA							4
ICF-2S13-H1-LD 1-Lamp	15'	NA	NA							4
ICF-2S13-M1-BS 2-Lamp	6'	Yes	Yes	2'	6'	6'				2
ICF-2S18-H1-LD 1-Lamp	15'	NA	NA							4
ICF-2S18-M1-BS 2-Lamp	6'	Yes	Yes	2'	6'	6'				2
ICF-2S26-H1-LD 1-Lamp	15'	NA	NA							4
ICF-2S26-M1-BS 2-Lamp	6'	Yes	Yes	2'	6'	6'				2
ICF-2S42-M2-BS 1-Lamp	15'	NA	NA							4
ICF-2S42-M2-LD 2-Lamp	6'	Yes	Yes	2'	6'	6'				2
ICF-2S42-90C-M2-BS 1-Lamp	15'	NA	NA							4
ICF-2S42-90C-M2-LD 2-Lamp	6'	Yes	Yes	2'	6'	6'				2
ICN-132-MC	20'	NA	NA							4
ICN-1P32-N	20'	NA	NA							4
ICN-1S80-T	20'	NA	NA							4
ICN-1TTP40-SC	20'	NA	NA							4
ICN-2M32-MC	20'	Yes	Yes	20'	20'					1
ICN-2P32-N	20'	Yes	Yes	20'	20'					1 (e)
ICN-2P60-N	20'	Yes	Yes	20'	20'					1
ICN-2S110-SC	20'	Yes	Yes	4'	20'	20'				2
ICN-2S24-N	20'	Yes	Yes	20'	4'	20'				3
ICN-2S24-T	20'	Yes	Yes	20'	4'	20'				3
ICN-2S28-85-N	10'	Yes	Yes	10'	10'	10'				3
ICN-2S28-N	10'	Yes	Yes	10'	10'	10'				3

	Allowed Wiring Configuration			Maximum Lead Length (Feet) for Tandem or Through Wiring (Total length of all wires between ballast and lamp sockets)						Application Note
	Remote (max length)	Tandem	Through	Blue	Red	Yellow	Blue/ White	Brown	Orange	
ICN-2S28-T	10'	Yes	Yes	10'	10'	10'				3
ICN-2S39-N	20'	Yes	Yes	20'	4'	20'				3
ICN-2S39-T	20'	Yes	Yes	20'	4'	20'				3
ICN-2S40-N	20'	Yes	Yes	4'	10'	10'				2
ICN-2S54-90C-N	20'	Yes	Yes	20'	4'	20'				3
ICN-2S54-90C-T	20'	Yes	Yes	20'	4'	20'				3
ICN-2S54-N	20'	Yes	Yes	20'	4'	20'				3
ICN-2S54-T	20'	Yes	Yes	20'	4'	20'				3
ICN-2S86-SC	12'	Yes	Yes	12'	4'	12'				3 (b)
ICN-2TTP40-SC	20'	Yes	Yes	20'	20'					1
ICN-3P32-N	20'	Yes	Yes	20'	20'					1 (e)
ICN-3S14-T	No	No	No							5
ICN-3TTP40-SC	20'	Yes	Yes	20'	20'					1
ICN-4P32-N	20'	Yes	Yes	20'	20'	20'				1 (e)
ICN-4S54-90C-2LS-G	20'	Yes	Yes	20'	4'	4'	20'	20'	20'	7
IDA-128-D	6'	NA	NA							4
IDA-132-SC	No	NA	NA							5
IDA-154	No	NA	NA							5
IDA-2S28-D	6'	Yes	Yes	6'	6'	6'				1
IDA-2S32-SC	No	No	Yes	5'	4'	4'				3
IDA-2S54	No	No	Yes	5'	4'	4'				3
IDA-3S32-G	No	No	No							5
IDA-4S32	No	No	Yes-8'	1'	1.25'	5.2'	1.25'	4.2'		3
IDL-2S26-M5-BS IDL-2S26-M5-LD	No	No	No							5
IDL-2T42-M5-BS IDL-2T42-M5-LD	No	No	No							5
IEZ-128-D	6'	NA	NA							5
IEZ-2S24-D	No	No	Yes	3'	2'	2'				3
IEZ-2S28-D	6'	Yes	Yes	6'	6'	6'				3
IOP-1P32-HL-N	20'	NA	Yes							1 (e)
IOP-1P32-LW-N	20'	NA	NA							1 (e)
IOP-1P32-N	20'	Yes	NA							1 (e)
IOP-1PSP32-LW-N	20'	NA	NA							4
IOP-1PSP32-N	20'	NA	NA							4
IOP-2P32-HL-N	20'	Yes	Yes	20'	20'					1 (e)
IOP-2P32-LW-N	20'	Yes	Yes	20'	20'					1 (e)
IOP-2P32-N	20'	Yes	Yes	20'	20'					1 (e)
IOP-2P59-N	20'	Yes	Yes	20'	20'					1 (e)
IOP-2PSP32-HL-N	20'	Yes	Yes	20'	20'	18'				1 (e)
IOP-2PSP32-LW-N	20'	Yes	Yes	20'	20'	18'				1 (e)
IOP-2PSP32-N	20'	Yes	Yes	20'	20'	18'				1 (e)
IOP-2PSP54-SC	20'	Yes	Yes	20'	20'	15'				1
IOP-2S28-115-SC	20'	Yes	Yes	20'	20'	20'				1
IOP-2S28-115-SC-SD	7'	Yes	Yes	7'	7'	7'				1
IOP-2S28-95-SC	20'	Yes	Yes	20'	20'	20'				1
IOP-2S28-95-SC-SD	7'	Yes	Yes	7'	7'	7'				1
IOP-2S32-SC-SD	7'	Yes	Yes	7'	7'	7'				1

	Allowed Wiring Configuration			Maximum Lead Length (Feet) for Tandem or Through Wiring (Total length of all wires between ballast and lamp sockets)						Application Note
	Remote (max length)	Tandem	Through	Blue	Red	Yellow	Blue/ White	Brown	Orange	
IOP-2S54-L-SD	7'	No	Yes	28"	28"	48"				1
IOP-3P32-HL-90C-N	20'	Yes	Yes	20'	20'					1(e)
IOP-3P32-HL-N	20'	Yes	Yes	20'	20'					1(e)
IOP-3P32-LW-N	20'	Yes	Yes	20'	20'					1(e)
IOP-3P32-N	20'	Yes	Yes	20'	20'					1(e)
IOP-3PSP32-HL-SC	20'	Yes	Yes	20'	20'	18'	18'			1(e)
IOP-3PSP32-LW-SC	20'	Yes	Yes	20'	20'	18'	18'			1(e)
IOP-3PSP32-SC	20'	Yes	Yes	20'	20'	18'	18'			1(e)
IOP-4P32-HL-90C-SC	20'	Yes	Yes	20'	20'	8'				1(e)
IOP-4P32-HL-SC	20'	Yes	Yes	20'	20'	8'				1(e)
IOP-4P32-LW-N	20'	Yes	Yes	20'	20'	8'				1(e)
IOP-4P32-N	20'	Yes	Yes	20'	20'	8'				1(e)
IOP-4PSP32-HL-G	20'	Yes	Yes	20'	20'	18'	18'	18'		1(e)
IOP-4PSP32-LW-SC	20'	Yes	Yes	20'	20'	18'	18'	18'		1(e)
IOP-4PSP32-SC	20'	Yes	Yes	20'	20'	18'	18'	18'		1(e)
IOP-4PSP54-2LS-G	20'	Yes	Yes	20'	20'	15'	15'	15'		1(e)
IOPA-1P32-HL-N	20'	Yes	Yes	20'	20'					1(e)
IOPA-1P32-LW-N	20'	Yes	Yes	20'	20'					1(e)
IOPA-1P32-N	20'	Yes	Yes	20'	20'					1(e)
IOPA-2P32-HL-N	20'	Yes	Yes	20'	20''					1(e)
IOPA-2P32-LW-N	20'	Yes	Yes	20'	20'					1(e)
IOPA-2P32-N	20'	Yes	Yes	20'	20''					1(e)
IOPA-3P32-HL-N	20'	Yes	Yes	20'	20''					1(e)
IOPA-3P32-LW-N	20'	Yes	Yes	20'	20'					1(e)
IOPA-3P32-N	20'	Yes	Yes	20'	20''					1(e)
IOPA-4P32-LW-N	20'	Yes	Yes	20'	20'	8'				1(e)
IOPA-4P32-N	20'	Yes	Yes	20'	20'	8'				1(e)
ISB-0216-12-E	No	Yes	Yes	20'	20'	20'				2(d)
ISB-0432-14-E	No	Yes	Yes	20'	20'	20'				2(d)
ISB-0848-46-E	No	Yes	Yes	20'	20'	20'				2(d)
ISB-1040-14-E	No	Yes	Yes	22'	22'	22'				2(d)
IUV-2S18-H1-LD 1-Lamp	15'	NA	NA							4
IUV-2S36-M2-LD 1-Lamp	15'	NA	NA							4
IUV-2S60-M4-LD	6'	Yes	Yes	2'	6'	6'				2
IZT-124-D	6'	NA	NA							5
IZT-128-D	6'	NA	NA							4
IZT-132-SC	6'	NA	NA							4
IZT-154-D	No	NA	NA							5
IZT-180-D	No	NA	NA							5
IZT-2PSP-32-SC	6'	Yes	Yes	6'	6'	6'				1
IZT-2S24-D	No	No	Yes	3'	2'	2'				3
IZT-2S26-M5-BS IZT-2S26-M5-LD	No	No	No							5
IZT-2S28-D	6'	Yes	Yes	6'	6'	6'				1
IZT-2S54-D	No	No	Yes	5'	4'	4'				3

	Allowed Wiring Configuration			Maximum Lead Length (Feet) for Tandem or Through Wiring (Total length of all wires between ballast and lamp sockets)						Application Note
	Remote (max length)	Tandem	Through	Blue	Red	Yellow	Blue/ White	Brown	Orange	
IZT-2T42-M5-BS IZT-2T42-M5-LD	No	No	No							5
IZT-2TTS40-SC	6'	No	No							4
IZT-3PSP-32-SC	No	No	No							5
IZT-4PSP32-G	No	No	Yes	5'	5'	1'	5'	R/W=5'		3
IZT-4S32	No	No	Yes	1'	1.25'	5.2'	1.25'	4.2'		3
RCF-2S13-M1-BS-QS 1-Lamp 2-Lamp	15'	No	No							4
	6'	Yes	Yes	2'	6'	6'				2
RCF-2S18-M1-BS-QS 1-Lamp 2-Lamp	15'	No	No							4
	6'	Yes	Yes	2'	6'	6'				2
RCF-2S26-H1-LD-QS RCF-2S26-M1-BS-QS 1-Lamp 2-Lamp	15'	No	No							4
	6'	Yes	Yes	2'	6'	6'				2
REB-2P32-N	20"	Yes	Yes	20'	20'					1
REB-4P32-SC	20"	Yes	Yes	20'	20'	20'				1
RELB-2S40-N	20"	Yes	Yes	4'	10'	10'				2
REZ-132-SC	6'	NA	NA							4
REZ-154	No	NA	NA							5
REZ-1Q18-M2-BS	No	NA	NA							5
REZ-1T42-M2-BS REZ-1T42-M2-LD	No	NA	NA							5
REZ-1TTS40-SC	6'	NA	NA							4
REZ-2Q18-M2-BS REZ-2Q18-M2-LD	No	No	No							5
REZ-2Q26-M2-BS REZ-2Q26-M2-LD	No	No	No							5
REZ-2S32-SC	6'	Yes	Yes	6'	6'	6'				1
REZ-2S54	No	No	Yes	5'	4'	4'				3
REZ-2T42-M3-BS REZ-2T42-M3-LD	No	No	No							5
REZ-2TTS40-SC	6'	No	No							5
REZ-3S32-SC	No	No	No							5
RK-2S32-TP	20'	Yes	Yes	4'	20'	20'				2 (a)
VEZ-132-SC	6'	NA	NA							4
VEZ-154	No	NA	NA							5
VEZ-1Q18-M2-BS	No	NA	NA							5
VEZ-1T42-M2-BS VEZ-1T42-M2-LD	No	NA	NA							5
VEZ-1TTS40-SC	6'	NA	NA							4
VEZ-2Q18-M2-BS VEZ-2Q18-M2-LD	No	No	No							5
VEZ-2Q26-M2-BS VEZ-2Q26-M2-LD	No	No	No							5
VEZ-2S32-SC	6'	Yes	Yes	6'	6'	6'				1
VEZ-2S54	No	No	Yes	5'	4'	4'				5
VEZ-2T42-M3-BS VEZ-2T42-M3-LD	No	No	No							5
VEZ-2TTS40-SC	6'	No	No							4
VEZ-3S32-SC	No	No	No							5
VK-2S32-TP	20'	Yes	Yes	4'	20'	20'				2 (a)
VZT-4S32-HL	No	No	Yes	1'	1.25'	5.2'	1.25'	4.2'		3

Notes

For nominal input voltage and 25°C ambient temperature.

Notes:

1. For Tandem or Through wiring, any lamp can be remote mounted.
2. For Tandem or Through wiring, BLUE lamp must be in same fixture as ballast.
3. For Tandem or Through wiring, RED lamp must be in same fixture as ballast.
4. No Tandem or Through wiring allowed.
5. No Remote, Tandem or Through wiring allowed.
6. For Tandem or Through wiring, RED lamp and BLUE lamp must be in same fixture as ballast.
7. For Tandem or Through wiring, RED lamp and YELLOW lamp must be in same fixture as ballast.
 - (a) Ballast can be Remote, Tandem or Through wired farther than 20'. Consult factory.
 - (b) Ballast can be Remote, Tandem or Through wired to a maximum 12 feet between ballast and lampholder for (2)F96T8/HO lamps or 20 feet for all other T8/HO lamps.
 - (c) Ballast can be Remote, Tandem or Through wired to a maximum 6 feet between ballast and lampholder for energy-saving lamps or 8 feet for standard lamps.
 - (d) For tandem wiring, lamp leads from multiple ballast cannot be run in same conduit. Separate conduit must be used for each ballast.
 - (e) Ballast can be Remote, Tandem or Through wired to a maximum of 20' for standard lamps and 6' for energy-saving lamps.
 - (f) Energy-saving lamps not allowed for Tandem wiring.

Use 18 AWG wire or larger.

DOE Legislation

The U.S. Department of Energy (DOE) issued an amended standard for fluorescent lamp ballasts which became effective on November 14, 2011. All covered fluorescent ballasts manufactured in or imported into the United States must comply. For more information on this amended standard, please visit https://www1.eere.energy.gov/buildings/appliance_standards/product.aspx/productid/62.

The amended standard covers fluorescent ballasts operating T12, T8, T5, T5HO and sign ballasts. This standard requires fluorescent ballasts to meet a minimum Ballast Luminous Efficiency (BLE) that is determined by the type of lamp operated and the arc power of the lamps. It is essentially a minimum efficiency standard based on lamp power compared to input watts.

The Circle-E logo is used to designate ballasts that comply with this new standard.

Reading Date Codes for Warranty Date on Electronic Ballasts

Most date codes are stamped on the back of the ballast (opposite the label side). The date code is part of a larger group of numbers and letters that call out the various codes for the factory where the ballast was manufactured. Depending upon which Philips Lighting factory manufactured the ballast, the date stamp can vary slightly in terms of its position on the ballast and the number sequence.

Some electronic ballasts manufactured from 1988 to 1991 may have the date code in ink stamped on the ballast label. Some ballasts have the manufacturing code printed in ink on the end of the ballast.

A typical date code for an electronic ballast will have the week and the year the ballast was manufactured. Some ballasts will have the day of the week included too.

Some examples of these different date codes that you may find are:

937N1B
B41893

The date code is the 18th week of 1993, stamped one line over the other.

937N1J
P23292

The date code is the 32nd week of 1992, stamped one line over the other.

16
93
973N20P3

The date code is the 16th week of 1993, stamped at the end of the ear on the back.

892P
259P
24
94

The date code is the 24th week of 1994, stamped on four separate lines.

91405BB0291N

The date code is the 2nd week of 1991, stamped on one line.

9716T032HD
120432IS24

The date code is the 16th week of 1997, stamped in ink on the end of the ballast.

693P0MMA
53301707

The date code is the 5th day, of the 33rd week of 2001, stamped on the back of the ballast.

The above examples are for ballasts that are already out of warranty. The next example is for ballasts that may still be covered under warranty. In 2006 the date code configuration was revised to this example.

06127M50
F2104571

The date code is the 127th day of 2006 stamped on the back of the ballast.

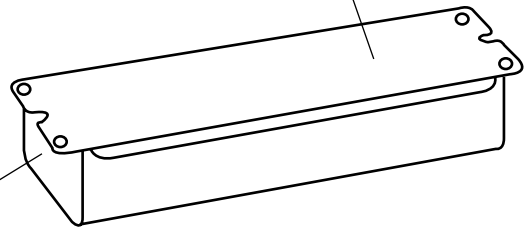

For assistance in determining a date code, call Customer Care (Technical Services /Warranty) at 1-800-372-3331.

SmartMate and Mark 10 Powerline Ballast Kits



Kit Contents and Key Features	Key Benefits
<p>SmartMate or Mark 10 Powerline ballast</p> <ul style="list-style-type: none"> • Intellivolt technology • Dual-entry color-coded connectors • Multi-lamp capability <p>Mounting Plate Adapter</p> <ul style="list-style-type: none"> • Multiple lead wire cutouts, including center hole • Integral mounting studs <p>Lead Wire</p> <ul style="list-style-type: none"> • Color-coded • Pre-stripped 3/8" on one end — 5/8" on the other <p>Wire Extraction Tool</p> <p>Individually Shrink-Wrapped Kits</p>	<p>Makes ballast selection and installation a breeze</p> <ul style="list-style-type: none"> • Provides full range input voltage from 120V to 277V • Adds to application versatility; simplifies wiring • Encompasses a wide variety of applications, including quads, triple tubes, circline, 2D and long twin-tube lamps <p>Takes the guess-work out of mounting</p> <ul style="list-style-type: none"> • Allows wiring and mounting to existing fixture's mounting plate • Eliminates need to stock units with and without studs <p>Allows installer to pre-wire</p> <ul style="list-style-type: none"> • Enables wiring accuracy • Meets UL poke-in connector requirements and facilitates final connection <p>Makes for quick disconnections if necessary</p>

- ICF-2S13-H1-LD-K REZ-2Q26-M2-LD-K
- ICF-2S18-H1-LD-K VEZ-2Q26-M2-LD-K
- ICF-2S26-H1-LD-K REZ-1T42-M2-LD-K
- ICF-2S42-M2-LD-K VEZ-1T42-M2-LD-K

Kits contain the standard ballasts.
For lamp and operational data consult
pages 3-22 through 3-28 and 4-5.

- Ideally suited for replacement of expired electronic ballasts, regardless of brand or mounting configuration.
- Dramatically simplifies the upgrading of incandescent fixtures to energy-saving CFL.
- Compatible with most J-Box covers

For 13-26W T4 Quad Lamps

HIGH POWER FACTOR SOUND RATED A



No. of Lamps	Input Volts	Lamp Starting Method	Ballast Family	Catalog Number	Input Power ANSI (Watts)	Ballast Factor	Max. THD %	Line Current (Amps)	Min. Starting Temp. (°F/°C)	Dim.	Wiring Dia.
CFQ13W/G24q - 13W CFL Quad Tube Lamp (PL-C13W/4P, F13DBX/4P, CF13DD/E)											
1	120	RS	AmbiStar	RCF-2S13-M1-BS-QS	16	1.00	10	0.13	0/-18	Size 1	160
	120-277			PS	SmartMate	ICF-2S13-M1-BS-QS	16	1.00			
		ICF-2S13-H1-LD									
		ICF-2S13-H1-LD-K ⑩									
2	120	RS	AmbiStar	RCF-2S13-M1-BS-QS	29	1.00	10	0.25	0/-18	Size 1	159
	120-277			PS	SmartMate	ICF-2S13-M1-BS-QS	29	1.00			
		ICF-2S13-H1-LD									
		ICF-2S13-H1-LD-K ⑩									
2	120-277	PS	SmartMate	ICF-2S13-M1-BS	29	1.00	10	0.25-0.11			
				ICF-2S13-H1-LD							
				ICF-2S13-H1-LD-K ⑩							
				ICF-2S13-M1-BS							
CFQ18W/G24q - 18W CFL Quad Tube Lamp (PL-C18W/4 P, F18DBX/4P, CF18DD/E)											
1	120	RS	AmbiStar	RCF-2S18-M1-BS-QS	19	1.00	10	0.16	0/-18	Size 1	160
	120-277			PS	SmartMate	ICF-2S18-M1-BS-QS	19	1.00			
		ICF-2S18-H1-LD									
		ICF-2S18-H1-LD-K ⑩									
2	120	RS	AmbiStar	RCF-2S18-M1-BS-QS	35	0.95	10	0.30	0/-18	Size 1	159
	120-277			PS	SmartMate	ICF-2S18-M1-BS-QS	35	0.95			
		ICF-2S18-H1-LD									
		ICF-2S18-H1-LD-K ⑩									
2	120-277	PS	SmartMate	ICF-2S18-M1-BS	35	0.95	10	0.30-0.13			
				ICF-2S18-H1-LD							
				ICF-2S18-H1-LD-K ⑩							
				ICF-2S18-M1-BS							
CFQR26W/G24q - 26W CFL Quad Tube Lamp (PL-C26W/4P, F26DBX/4P, CF26DD/E)											
1	120	RS	AmbiStar	RCF-2S26-H1-LD-QS	27	1.00	10	0.23	0/-18	Size 1	160
	120-277			PS							
		ICF-2S26-H1-LD									
		ICF-2S26-H1-LD-K ⑩									
2	120	RS	AmbiStar	RCF-2S26-M1-BS-QS	51	1.00	10	0.43	0/-18	Size 1	159
				PS							
		ICF-2S26-H1-LD									
		ICF-2S26-H1-LD-K ⑩									
	120-277	PS	SmartMate	ICF-2S26-M1-BS	52	1.00	10	0.43-0.19			
				ICF-2S42-M2-BS							
				ICF-2S42-M2-LD							
				ICF-2S42-M2-LD-K ⑩							
2	120-277	PS	SmartMate	ICF-2S42-90C-M2-BS	52	1.00	10	0.43-0.19			
				ICF-2S42-90C-M2-LD							
				ICF-2S42-90C-M2-BS							
				ICF-2S42-90C-M2-LD							

⑩ Replacement/Retrofit ballast kits indicated with suffix K are available to distributors. Refer to page 3-21 for details.

Refer to page 3-26 for dimensions and wiring diagrams.
Refer to pages 9-24 to 9-28 for lead lengths and shipping data.

For 13-26W Triple T4 Lamps

HIGH POWER FACTOR SOUND RATED A



No. of Lamps	Input Volts	Lamp Starting Method	Ballast Family	Catalog Number	Input Power ANSI (Watts)	Ballast Factor	Max. THD %	Line Current (Amps)	Min. Starting Temp. (°F/°C)	Dim.	Wiring Dia.
CFTR13W/GX24q - 13W CFL Triple Tube Lamp (F13TBX/4P, CF13DT/E)											
1	120	RS	AmbiStar	RCF-2S13-M1-BS-QS	16	1.00	10	0.13	0/-18	Size 1	160
	120-277		PS	SmartMate	ICF-2S13-M1-BS-QS	16	1.00	10			
		ICF-2S13-H1-LD									
		ICF-2S13-H1-LD-K ⑩									
ICF-2S13-M1-BS											
2	120	RS	AmbiStar	RCF-2S13-M1-BS-QS	29	1.00	10	0.25	0/-18	Size 1	159
	120-277		PS	SmartMate	ICF-2S13-M1-BS-QS	29	1.00	10			
		ICF-2S13-H1-LD									
		ICF-2S13-H1-LD-K ⑩									
ICF-2S13-M1-BS											
CFTR18W/GX24q - 18W CFL Triple Tube Lamp (PL-T18W, F18TBX/4P, CF18DT/E)											
1	120	RS	AmbiStar	RCF-2S18-M1-BS-QS	20	1.05	10	0.17	0/-18	Size 1	160
	120-277		PS	SmartMate	ICF-2S18-M1-BS-QS	20	1.05	10			
		ICF-2S18-H1-LD									
		ICF-2S18-H1-LD-K ⑩									
ICF-2S18-M1-BS											
2	120	RS	AmbiStar	RCF-2S18-M1-BS-QS	39	1.05	10	0.33	0/-18	Size 1	159
	120-277		PS	SmartMate	ICF-2S18-M1-BS-QS	39	1.05	10			
		ICF-2S18-H1-LD									
		ICF-2S18-H1-LD-K ⑩									
ICF-2S18-M1-BS											
CFTR26W/GX24q - 26W CFL Triple Tube Lamp (PL-T26W, F26TBX/4P, CF26DT/E)											
1	120	RS	AmbiStar	RCF-2S26-H1-LD-QS	29	1.10	10	0.24	0/-18	Size 1	160
	120-277		PS	SmartMate							
		ICF-2S26-M1-BS-QS									
		ICF-2S26-H1-LD									
ICF-2S26-H1-LD-K ⑩											
ICF-2S26-M1-BS											
2	120	RS	AmbiStar	RCF-2S26-H1-LD-QS	54	1.00	10	0.45	0/-18	Size 1	159
	120-277		PS	SmartMate							
		ICF-2S26-M1-BS-QS									
		ICF-2S26-H1-LD									
		ICF-2S26-H1-LD-K ⑩									
		ICF-2S26-M1-BS									
		ICF-2S42-M2-BS									
	ICF-2S42-M2-LD										
ICF-2S42-M2-LD-K ⑩											
ICF-2S42-90C-M2-BS											
ICF-2S42-90C-M2-LD											
55	1.00	10	0.46-0.21	Size 2							

⑩ Replacement/Retrofit ballast kits indicated with suffix K are available to distributors. Refer to page 3-21 for details.

Refer to page 3-26 for dimensions and wiring diagrams.
 Refer to pages 9-24 to 9-28 for lead lengths and shipping data.

For 32-70W Triple T4 Lamps

HIGH POWER FACTOR SOUND RATED A



No. of Lamps	Input Volts	Lamp Starting Method	Ballast Family	Catalog Number	Input Power ANSI (Watts)	Ballast Factor	Max. THD %	Line Current (Amps)	Min. Starting Temp. (°F/°C)	Dim.	Wiring Dia.
CFTR32W/GX24q - 32W CFL Triple Tube Lamp (PL-T32W, F32TBX/4P, CF32DT/E)											
1	120	RS	AmbiStar	RCF-2S26-H1-LD-QS	36	0.98	10	0.31	0/-18	Size 1	160
				RCF-2S26-M1-BS-QS							
	120-277	PS	SmartMate	ICF-2S26-M1-BS-QS	36	0.98	10	0.31-0.13			
				ICF-2S26-H1-LD							
				ICF-2S26-H1-LD-K ⑩							
2	120-277	PS	SmartMate	ICF-2S42-M2-BS	68	0.98	10	0.57-0.25	0/-18	Size 2	159
				ICF-2S42-M2-LD							
				ICF-2S42-M2-LD-K ⑩							
				ICF-2S42-90C-M2-BS							
CFTR42W/GX24q - 42W CFL Triple Tube Lamp (PL-T42W, F42TBX/4P, CF42DT/E)											
1	120	RS	AmbiStar	RCF-2S26-H1-LD-QS	46	0.98	10	0.38	0/-18	Size 1	160
				RCF-2S26-M1-BS-QS							
	120-277	PS	SmartMate	ICF-2S26-M1-BS-QS	46	0.98	10	0.38-0.17			
				ICF-2S26-H1-LD							
				ICF-2S26-H1-LD-K ⑩							
2	120-277	PS	SmartMate	ICF-2S42-M2-BS	93	0.97	10	0.78-0.33	0/-18	Size 2	159
				ICF-2S42-M2-LD							
				ICF-2S42-M2-LD-K ⑩							
				ICF-2S42-90C-M2-BS							
CFTR57W/GX24q - 57W CFL Lamp (PL-T57W, F57QBX/4P, CF57DT/E)											
1	120-277	PS	SmartMate	ICF-2S42-M2-BS	59	0.94	10	0.50-0.21	0/-18	Size 2	160
				ICF-2S42-M2-LD							
				ICF-2S42-M2-LD-K ⑩							
				ICF-2S42-90C-M2-BS							
				ICF-2S42-90C-M2-LD							
CFTR70W/GX24q - 70W CFL Lamp (F70QBX/4P, CF70DT/E)											
1	120-277	PS	SmartMate	ICF-2S42-M2-BS	75	0.96	10	0.63-0.27	0/-18	Size 2	160
				ICF-2S42-M2-LD							
				ICF-2S42-M2-LD-K ⑩							
				ICF-2S42-90C-M2-BS							
				ICF-2S42-90C-M2-LD							

⑩ Replacement/Retrofit ballast kits indicated with suffix K are available to distributors. Refer to page 3-21 for details.

Refer to page 3-26 for dimensions and wiring diagrams.
 Refer to pages 9-24 to 9-28 for lead lengths and shipping data.

For 10-38W 2D Lamps

HIGH POWER FACTOR SOUND RATED A



No. of Lamps	Input Volts	Lamp Starting Method	Ballast Family	Catalog Number	Input Power ANSI (Watts)	Ballast Factor	Max. THD %	Line Current (Amps)	Min. Starting Temp. (°F/°C)	Dim.	Wiring Dia.
CFS10W/GR10q - 10W 2D Lamp (F10 2D/4P)											
1	120-277	PS	SmartMate	ICF-2S13-H1-LD	13	1.05	15	0.11-0.05	0/-18	Size 1	160
				ICF-2S13-H1-LD-K ⑩							
				ICF-2S13-M1-BS							
2	120-277	PS	SmartMate	ICF-2S13-H1-LD	23	0.95	15	0.19-0.09	0/-18	Size 1	159
				ICF-2S13-H1-LD-K ⑩							
				ICF-2S13-M1-BS							
CFS16W/GR10q - 16W 2D Lamp (F16 2D/4P)											
1	120-277	PS	SmartMate	ICF-2S13-H1-LD	17	1.00	15	0.14-0.06	0/-18	Size 1	160
				ICF-2S13-H1-LD-K ⑩							
				ICF-2S13-M1-BS							
2	120-277	PS	SmartMate	ICF-2S18-H1-LD	37	1.00	10	0.31-0.13	0/-18	Size 1	159
				ICF-2S18-H1-LD-K ⑩							
				ICF-2S18-M1-BS							
CFS21W/GR10q - 21W 2D Lamp (F21 2D/4P)											
1	120-277	PS	SmartMate	ICF-2S18-H1-LD	20	0.90	15	0.16-0.07	0/-18	Size 1	160
				ICF-2S18-H1-LD-K ⑩							
				ICF-2S18-M1-BS							
2	120-277	PS	SmartMate	ICF-2S18-H1-LD	40	0.91	10	0.33-0.14	0/-18	Size 1	159
				ICF-2S18-H1-LD-K ⑩							
				ICF-2S18-M1-BS							
				ICF-2S26-H1-LD	51	1.12	10	0.42-0.18			
				ICF-2S26-H1-LD-K ⑩							
ICF-2S26-M1-BS											
CFS28W/GR10q - 28W 2D Lamp (PL-Q 28W/4P, F28 2D/4P)											
1	120-277	PS	SmartMate	ICF-1D38-H1-LD	27	1.00	10	0.23-0.10	0/-18	Size 1	160
2	120-277	PS	SmartMate	ICF-2S42-M2-BS	57	1.00	10	0.48-0.21	0/-18	Size 2	159
				ICF-2S42-M2-LD							
				ICF-2S42-M2-LD-K ⑩							
				ICF-2S42-90C-M2-BS							
ICF-2S42-90C-M2-LD											
CFS38W/GR10q - 38W 2D Lamp (PL-Q 38W/4P, F38 2D/4P)											
1	120-277	PS	SmartMate	ICF-1D38-H1-LD	31	0.85	10	0.26-0.11	0/-18	Size 1	160
2	120-277	PS	SmartMate	ICF-2S42-M2-BS	62	0.80	10	0.55-0.23	0/-18	Size 2	159
				ICF-2S42-M2-LD							
				ICF-2S42-M2-LD-K ⑩							
				ICF-2S42-90C-M2-BS							
				ICF-2S42-90C-M2-LD							

⑩ Replacement/Retrofit ballast kits indicated with suffix K are available to distributors. Refer to page 3-21 for details.

Refer to page 3-26 for dimensions and wiring diagrams.
Refer to pages 9-24 to 9-28 for lead lengths and shipping data.

CFL Wiring Diagrams and Dimensions

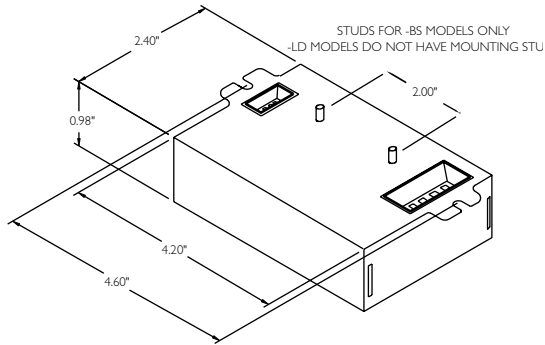

Size 1 Enclosure

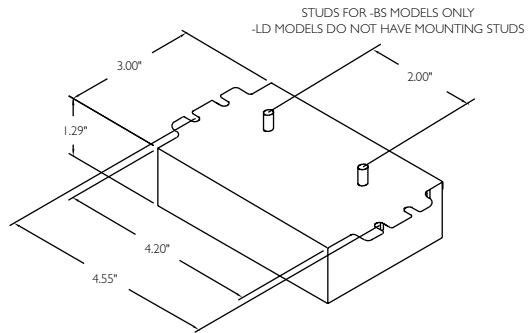

Size 2 Enclosure

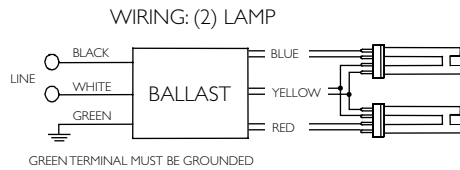

Diag. 159

Note: For AmbiStar 1-lamp operation on 2-lamp ballast, use red and blue connectors

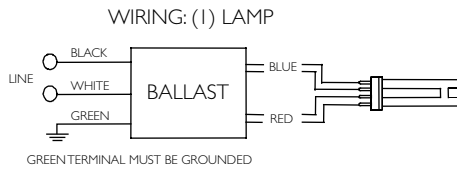

Diag. 160

Refer to pages 9-24 to 9-28 for lead lengths and shipping data.

For 24-36W FT5 Lamps

HIGH POWER FACTOR SOUND RATED A



No. of Lamps	Input Volts	Lamp Starting Method	Ballast Family	Catalog Number	Input Power ANSI (Watts)	Ballast Factor	Max. THD %	Line Current (Amps)	Min. Starting Temp. (°F/°C)	Dim.	Wiring Dia.		
FT24W/2G11 - 24/27W (PL-L24W, F27BX/RS, FT24DL)													
1	120-277	PS	Centium	ICN-2S24-N	26	0.99	20	0.21-0.10	0/-18	N	73		
				ICN-2S24-T								1.02	10
				ICN-2S39-N	29	1.11	15	0.24-0.13				T	
				ICN-2S39-T									1.12
2	120-277	PS	SmartMate	ICF-2S26-H1-LD	48	0.93	10	0.41-0.18	0/-18	Size 1	160		
				ICF-2S26-H1-LD-K ⑩									
				ICF-2S26-M1-BS									
				ICF-2S42-M2-BS	48	0.93	15	0.40-0.18				Size 2	159
				ICF-2S42-M2-LD									
				ICF-2S42-M2-LD-K ⑩									
			ICF-2S42-90C-M2-BS	51-50	1.01	10	0.43-0.18	N					
			ICF-2S42-90C-M2-LD										
			ICN-2S24-N	51	1.00	10	0.42-0.18			T			
			ICN-2S24-T	56-55	1.11						0.47-0.21		
ICN-2S39-N	54	1.10	0.46-0.20	N									
ICN-2S39-T								T					
FT36W/2G11 - 36/39W (PL-L36W, F39BX/RS, FT36DL)													
1	120-277	PS	Centium	ICN-2S24-N	31	0.84	15	0.26-0.12	0/-18	N	73		
				ICN-2S24-T	33	0.90	10	0.28-0.12					
				ICN-2S39-N	34-33	0.90	15	0.28-0.15					
				ICN-2S39-T	36	0.96	10	0.30-0.13					
				ICN-2S54-N	45	1.24	20	0.37-0.17					
				ICN-2S54-T	44	1.20	10	0.37-0.16					
				ICN-2S54-90C-N	45	1.24	20	0.37-0.17					
	ICN-2S54-90C-T		44	1.20	10	0.37-0.16	-20/-29	T					
	Optanium		IOP-2PSP54-SC	46	1.20	10			0.39-0.18	B	77		
	Centium		HCN-2S54-90C-WL	46	1.22	15			0.13-0.10	L	73		
347-480	Optanium	HOP-2PSP54-L	46	1.00	10	0.13-0.10	L	77					
2	120-277	PS	Centium	ICN-2S39-N	66-65	0.90	10	0.55-0.24	0/-18	N	74A		
				ICN-2S39-T	69	0.94		0.59-0.25					
				ICN-2S54-N	88-87	1.24		0.74-0.32					
				ICN-2S54-T	82-81	1.16		0.68-0.29					
				ICN-2S54-90C-N	88-87	1.24		0.74-0.32					
				ICN-2S54-90C-T	82-81	1.16		0.68-0.29					
	Optanium		IOP-2PSP54-SC	88-85	1.20	10	0.73-0.31	-20/-29	T				
	Centium		HCN-2S54-90C-WL	89	1.20	10	0.26-0.19			B	78		
	Optanium		HOP-2PSP54-L	87	1.00	10	0.25-0.18			L	74A		
347-480	Optanium	HOP-2PSP54-L	87	1.00	10	0.25-0.18	L	78					
3	120-277	PS	Centium	ICN-4S54-90C-2LS-G	133-132	1.20	10	1.11-0.49	-20/-29	G	75A		
			Optanium	IOP-4P2P54-2LS-G	128-127	1.20	10	1.07-0.31					
	Centium		HCN-4S54-90C-2LS-G	137-135	1.20	10	0.40-0.29						
	Optanium		HOP-4PSP54-2LS-G	129	1.00	10	0.38-0.28						
347-480	Optanium	HOP-4PSP54-2LS-G	129	1.00	10	0.38-0.28			80				
4	120-277	PS	Centium	ICN-4S54-90C-2LS-G	176-173	1.20	10	1.47-0.64	-20/-29	G	75		
			Optanium	IOP-4P2P54-2LS-G	170-167	1.20	10	1.42-0.61					
	Centium		HCN-4S54-90C-2LS-G	182-180	1.20	10	0.53-0.38						
	Optanium		HOP-4PSP54-2LS-G	172	1.00	10	0.50-0.37						
347-480	Optanium	HOP-4PSP54-2LS-G	172	1.00	10	0.50-0.37			79				

Refer to page 3-38 for dimensions.
 Refer to pages 3-26, 3-36 & 3-37 for wiring diagrams.
 Refer to pages 9-24 to 9-28 for lead lengths and shipping data.

⑩ Replacement/Retrofit ballast kits indicated with suffix K are available to distributors. Refer to page 3-21 for details.

For 40W & 50W FT5 Lamps

HIGH POWER FACTOR SOUND RATED A



No. of Lamps	Input Volts	Lamp Starting Method	Ballast Family	Catalog Number	Input Power ANSI (Watts)	Ballast Factor	Max. THD %	Line Current (Amps)	Min. Starting Temp. (°F/°C)	Dim.	Wiring Dia.
FT40W/2G11/RS - 40W (PL-L40W, F40BX, FT40DL/RS)											
1	120-277	IS	Centium	ICN-1TTP40-SC	39	0.90	10	0.33-0.14	0/-18	B	70
				ICN-2TTP40-SC	41	1.00	10	0.35-0.15			
				ICN-2S24-N	42	0.94	15	0.36-0.16			
				ICN-2S24-T	46	1.00	10	0.39-0.17			
				ICN-2S39-N	45	0.99	10	0.37-0.17			
		PS	SmartMate	ICN-2S39-T	50	1.10	10	0.42-0.19		N	73
				ICF-2S42-M2-BS	44	0.95	10	0.37-0.16			
				ICF-2S42-M2-LD-K ⑩							
				ICF-2S42-M2-LD							
				ICF-2S42-90C-M2-BS							
ICF-2S42-90C-M2-LD											
2	120-277	IS	Centium	ICN-2TTP40-SC	67	0.88	10	0.57-0.25	0/-18	B	71
				ICN-3TTP40-SC	72	0.96	10	0.61-0.27			
		PS	SmartMate	ICF-2S42-M2-BS	78	0.95	10	0.66-0.28		Size 2	159
				ICF-2S42-M2-LD							
				ICF-2S42-M2-LD-K ⑩							
				ICF-2S42-90C-M2-BS							
				ICF-2S42-90C-M2-LD							
				ICF-2S42-90C-M2-LD							
3	120-277	IS	Centium	ICN-3TTP40-SC	99	0.88	10	0.83-0.35	0/-18	B	72
FT50W/2G11/RS - 50W (PL-L50W, F50BX/RS)											
1	120-277	PS	Centium	ICN-2S54-N	61	1.12	15	0.51-0.23	-20/-29	N	73
				ICN-2S54-T	60	1.11	10	0.50-0.22			
				ICN-2S54-90C-N	61	1.12	15	0.51-0.23			
				ICN-2S54-90C-T	60	1.11	10	0.50-0.22			
	347-480		Optanium	IOP-2PSP54-SC	61	1.10	10	0.51-0.23		B	77
			Centium	HCN-2S54-90C-WL	61	1.12	10	0.18-0.13			
			Optanium	HOP-2PSP54-L	60	1.00	10	0.17-0.13			
2	120-277	PS	Centium	ICN-2S54-N	118-115	1.07	10	0.99-0.43	-20/-29	N	74A
				ICN-2S54-T	111-109	1.03	10	0.92-0.39			
				ICN-2S54-90C-N	118-115	1.07	10	0.99-0.43			
				ICN-2S54-90C-T	111-109	1.03	10	0.92-0.39			
	347-480		Optanium	IOP-2PSP54-SC	117-114	1.10	10	0.97-0.42		B	78
			Centium	HCN-2S54-90C-WL	118	1.10	10	0.34-0.25			
			Optanium	HOP-2PSP54-L	116	1.00	10	0.33-0.24			
			Optanium	HOP-2PSP54-L	116	1.00	10	0.33-0.24			
3	120-277	PS	Centium	ICN-4S54-90C-2LS-G	178-175	1.10	10	1.49-0.65	-20/-29	G	75A
			Optanium	IOP-4PSP54-2LS-G	172-169	1.10	10	1.44-0.62			
	347-480		Centium	HCN-4S54-90C-2LS-G	185-183	1.10	10	0.54-0.39			
			Optanium	HOP-4PSP54-2LS-G	177	1.00	10	0.51-0.38			
4	120-277	PS	Centium	ICN-4S54-90C-2LS-G	235-230	1.10	10	1.96-0.84	-20/-29	G	75
			Optanium	IOP-4PSP54-2LS-G	228-223	1.10	10	1.90-0.81			
	347-480		Centium	HCN-4S54-90C-2LS-G	236-234	1.10	10	0.68-0.49			
			Optanium	HOP-4PSP54-2LS-G	238	1.00	10	0.69-0.50			

⑩ Replacement/Retrofit ballast kits indicated with suffix K are available to distributors. Refer to page 3-21 for details.

Refer to page 3-38 for dimensions.
 Refer to pages 3-26, 3-36 & 3-37 for wiring diagrams.
 Refer to pages 9-24 to 9-28 for lead lengths and shipping data.

For 55-80W FT5 Lamps

HIGH POWER FACTOR SOUND RATED A



No. of Lamps	Input Volts	Lamp Starting Method	Ballast Family	Catalog Number	Input Power ANSI (Watts)	Ballast Factor	Max. THD %	Line Current (Amps)	Min. Starting Temp. (°F/°C)	Dim.	Wiring Dia.
FT55W/2G11 - 55W (PL-L55W, F55BX, FT55DL)											
1	120-277	PS	Centium	ICN-2S54-N	58	0.98	15	0.49-0.22	-20/-29	N	73
				ICN-2S54-T	58	0.92	10	0.49-0.21		T	
				ICN-2S54-90C-N	58	0.98	15	0.49-0.22		N	
				ICN-2S54-90C-T	58	0.92	10	0.49-0.21		T	
	347-480		Optanium	IOP-2PSP54-SC	58	0.90	10	0.49-0.22		B	77
			Centium	HCN-2S54-90C-WL	58	0.92	10	0.17-0.13		L	73
2	120-277	PS	Centium	ICN-2S54-N	112-109	0.93	10	0.94-0.41	-20/-29	N	74A
				ICN-2S54-T	108-105	0.90	10	0.90-0.38		T	
				ICN-2S54-90C-N	112-109	0.93	10	0.94-0.41		N	
				ICN-2S54-90C-T	108-105	0.90	10	0.90-0.38		T	
	347-480		Optanium	IOP-2PSP54-SC	110-108	0.90	10	0.92-0.40		B	78
			Centium	HCN-2S54-90C-WL	112	0.90	10	0.33-0.24		L	74A
3	120-277	PS	Centium	ICN-4S54-90C-2LS-G	169-166	0.90	10	1.41-0.61	-20/-29	G	75A
			Optanium	IOP-4PSP54-2LS-G	164-161	0.90	10	1.37-0.59			80
	347-480		Centium	HCN-4S54-90C-2LS-G	178-176	0.90	10	0.52-0.37			75A
			Optanium	HOP-4PSP54-2LS-G	165	1.00	10	0.48-0.35			80
4	120-277	PS	Centium	ICN-4S54-90C-2LS-G	222-217	0.90	10	1.86-0.80	-20/-29	G	75
			Optanium	IOP-4PSP54-2LS-G	217-212	0.90	10	1.81-0.77			79
	347-480		Centium	HCN-4S54-90C-2LS-G	228-226	0.90	10	0.66-0.47			75
			Optanium	HOP-4PSP54-2LS-G	222	1.00	10	0.64-0.47			79
FT80W/2G11 - 80W (PL-L80W, FT80DL)											
1	120-277	PS	Centium	ICN-1S80-T	90-88	1.00	10	0.74-0.32	0/-18	T	73

Refer to pages 3-36 to 3-38 for dimensions and wiring diagrams
Refer to pages 9-24 to 9-28 for lead lengths and shipping data

For 14-25W T5 Lamps

HIGH POWER FACTOR SOUND RATED A



No. of Lamps	Input Volts	Lamp Starting Method	Ballast Family	Catalog Number	Input Power ANSI (Watts)	Ballast Factor	Max. THD %	Line Current (Amps)	Min. Starting Temp. (°F/°C)	Dim.	Wiring Dia.
F14T5 (14W)											
1	120-277	PS	Centium	ICN-2S28-85-N	14	0.88	20	0.12-0.06	0/-18	N	73
				ICN-2S28-N	17	1.07	10	0.14-0.07		T	
	ICN-2S28-T		17	1.07	15	0.14-0.07	B				
	Optanium		IOP-2S28-115-SC	19	1.15	15	0.15-0.08	L			
347		Centium	GCN-2S28-L	18	1.09	15	0.06				
2	120-277	PS	Centium	ICN-2S28-85-N	27	0.86	10	0.23-0.10	0/-18	N	74
				ICN-2S28-N	33	1.04	10	0.28-0.13		T	172
			ICN-2S28-T	32	1.06	10	0.27-0.12	T			
			ICN-3S14-T	35	1.10	10	0.29-0.13	T			
	347		Optanium	IOP-2S28-95-SC	30	0.95	15	0.25-0.11		B	74
				IOP-2S28-115-SC	37	1.15	10	0.30-0.14		B	
	Centium	GCN-2S28-L	33	1.10	15	0.10	L				
3	120-277	PS	Centium	ICN-3S14-T	48	1.00	10	0.40-0.17	0/-18	T	171
F21T5 (21W)											
1	120-277	PS	Centium	ICN-2S28-85-N	21	0.88	15	0.18-0.08	0/-18	N	73
				ICN-2S28-N	25	1.06	10	0.22-0.10		T	
	ICN-2S28-T		23	1.03	15	0.19-0.09	T				
	Optanium		IOP-2S28-95-SC	23	0.95	15	0.19-0.08	B			
347		Optanium	IOP-2S28-115-SC	27	1.15	15	0.22-0.10				
	Centium	GCN-2S28-L	25	1.05	15	0.08	L				
2	120-277	PS	Centium	ICN-2S28-85-N	41-40	0.86	10	0.34-0.15	0/-18	N	74
				ICN-2S28-N	49	1.02	10	0.43-0.19		T	
			ICN-2S28-T	46-45	1.02	10	0.38-0.17	T			
			Optanium	IOP-2S28-95-SC	44	0.95	10	0.37-0.16		B	
	347		Optanium	IOP-2S28-115-SC	52	1.15	10	0.44-0.19		B	
				Centium	GCN-2S28-L	47	1.05	15		0.14	L
F28T5 (25W)											
1	120-277	PS	Centium	ICN-2S28-85-N	25	0.87	15	0.21-0.09	0/-18	N	73
				ICN-2S28-N	30	1.05	10	0.25-0.11		T	
	ICN-2S28-T		28	1.00	10	0.24-0.11	T				
	Optanium		IOP-2S28-95-SC	27	0.95	10	0.22-0.10	B			
347		Optanium	IOP-2S28-115-SC	33	1.15	10	0.27-0.12				
	Centium	GCN-2S28-L	30	1.03	10	0.09	L				
2	120-277	PS	Centium	ICN-2S28-85-N	50-49	0.85	10	0.42-0.18	0/-18	N	74
				ICN-2S28-N	58-57	1.00	10	0.49-0.21		T	
			ICN-2S28-T	56-55	1.00	10	0.47-0.20	T			
			Optanium	IOP-2S28-95-SC	54	0.95	10	0.45-0.20		B	
	347		Optanium	IOP-2S28-115-SC	64-63	1.15	10	0.54-0.23		B	
				Centium	GCN-2S28-L	56	1.03	10		0.16	L

Refer to page 3-36 to 3-38 for dimensions and wiring diagrams.
Refer to pages 9-24 to 9-28 for lead lengths and shipping data.

For 28-35W T5 Lamps

HIGH POWER FACTOR SOUND RATED A



No. of Lamps	Input Volts	Lamp Starting Method	Ballast Family	Catalog Number	Input Power ANSI (Watts)	Ballast Factor	Max. THD %	Line Current (Amps)	Min. Starting Temp. (°F/°C)	Dim.	Wiring Dia.
F28T5 (28W)											
1	120-277	PS	Centium	ICN-2S28-85-N	28	0.87	10	0.24-0.10	0/-18	N	73
				ICN-2S28-N	31	1.05	10	0.29-0.12		T	
				ICN-2S28-T	31	1.00	10	0.27-0.12		B	
			Optanium	IOP-2S28-95-SC	30	0.95	15	0.25-0.11		L	
	IOP-2S28-115-SC		36	1.15	10	0.30-0.13					
347	Centium	GCN-2S28-L	34	1.08	10	0.10					
2	120-277	PS	Centium	ICN-2S28-85-N	54-53	0.85	10	0.45-0.19	0/-18	N	74
				ICN-2S28-N	61-60	1.00	10	0.59-0.23		T	
				ICN-2S28-T	62-61	1.00	10	0.51-0.23		B	
			Optanium	IOP-2S28-95-SC	59-58	0.95	15	0.55-0.22		L	
	IOP-2S28-115-SC		71-69	1.15	10	0.60-0.26					
347	Centium	GCN-2S28-L	60	1.01	10	0.17					
F35T5 (35W)											
1	120-277	PS	Centium	ICN-2S28-85-N	34	0.88	10	0.28-0.13	0/-18	N	73
				ICN-2S28-N	40	1.01	10	0.34-0.15		T	
				ICN-2S28-T	39	1.00	10	0.34-0.15		B	
			Optanium	IOP-2S28-95-SC	37	0.95	10	0.31-0.14		L	
	IOP-2S28-115-SC		44	1.15	10	0.37-0.17					
347	Centium	GCN-2S28-L	41	1.06	15	0.12					
2	120-277	PS	Centium	ICN-2S28-T	77-75	1.00	10	0.64-0.28	0/-18	T	74

Refer to page 3-36 to 3-38 for dimensions and wiring diagrams.
Refer to pages 9-24 to 9-28 for lead lengths and shipping data.

For 22-55W T5 & T5HO Lamps

HIGH POWER FACTOR SOUND RATED A



No. of Lamps	Input Volts	Lamp Starting Method	Ballast Family	Catalog Number	Input Power ANSI (Watts)	Ballast Factor	Max. THD %	Line Current (Amps)	Min. Starting Temp. (°F/°C)	Dim.	Wiring Dia.
FC9T5 (22W Circline)											
1	120-277	PS	SmartMate	ICF-1D38-H1-LD	25	1.00	15	0.21-0.09	0/-18	Size 1	73
			Centium	ICN-2S24-N	28	0.98	20	0.22-0.11		N	73
				ICN-2S24-T	26	1.02	10	0.22-0.10		T	
				ICN-2S39-N	29	1.09	20	0.24-0.11		N	
2	120-277	PS	Centium	ICN-2S24-N	49	0.98	10	0.41-0.18	0/-18	N	74
				ICN-2S24-T	51	1.00	10	0.42-0.18		T	
				ICN-2S39-N	54	1.07	15	0.45-0.20		N	
				ICN-2S39-T	54	1.10	10	0.46-0.20		T	
FC12T5 (40W Circline)											
1	120-277	PS	SmartMate	ICF-1D38-H1-LD	38	0.95	10	0.32-0.14	0/-18	Size 1	73
			Centium	ICN-2S24-N	39-38	0.84	15	0.32-0.14		N	73
				ICN-2S24-T	40	0.84	10	0.33-0.15		T	
				ICN-2S39-N	45	1.03	15	0.38-0.17		N	
2	120-277	PS	Centium	ICN-2S39-N	81	0.91	10	0.68-0.30	0/-18	N	74
				ICN-2S39-T	79	0.90	10	0.66-0.29		T	
(1) FC9T5 & (1) FC12T5 {(1) 22W & (1) 40W Circline}											
1&1	120-277	PS	SmartMate	ICF-2S42-M2-BS	61	0.85	10	0.51-0.22	0/-18	Size 2	159
				ICF-2S42-M2-LD							
				ICF-2S42-M2-LD-K ⑩							
				ICF-2S42-90C-M2-BS							
			Centium	ICN-2S39-N	66	0.94	10	0.56-0.24		N	74
				ICN-2S39-T	68	1.00	10	0.57-0.25		T	
FC12T5/HO (55W Circline)											
1	120-277	PS	Centium	ICN-2S54-N	58	0.95	15	0.49-0.22	-20/-29	N	73
				ICN-2S54-T	58	0.92	10	0.49-0.21		T	
	347-480			ICN-2S54-90C-N	58	0.95	15	0.49-0.22		N	
				ICN-2S54-90C-T	58	0.92	10	0.49-0.21		T	
2	120-277	PS	Centium	ICN-2S54-N	109-107	0.90	10	0.91-0.39	-20/-29	N	74
				ICN-2S54-T	110-108	0.88	10	0.92-0.39		T	
	347-480			ICN-2S54-90C-N	109-107	0.90	10	0.91-0.39		N	
				ICN-2S54-90C-T	110-108	0.88	10	0.92-0.39		T	
				HCN-2S54-90C-WL	106	0.85	10	0.31-0.22		L	

⑩ Replacement/Retrofit ballast kits indicated with suffix K are available to distributors. Refer to page 3-21 for details.

Refer to page 3-38 for dimensions
 Refer to pages 3-26, 3-36 & 3-37 for wiring diagrams
 Refer to pages 9-24 to 9-28 for lead lengths and shipping data

For 24-44W T5HO Lamps

HIGH POWER FACTOR SOUND RATED A



No. of Lamps	Input Volts	Lamp Starting Method	Ballast Family	Catalog Number	Input Power ANSI (Watts)	Ballast Factor	Max. THD %	Line Current (Amps)	Min. Starting Temp. (°F/°C)	Dim.	Wiring Dia.	
F24T5/HO (24W)												
1	120-277	PS	Centium	ICN-2S24-N	27	1.03	10	0.23-0.10	0/-18	N	73	
				ICN-2S24-T	26	1.02	10	0.22-0.10		T		
				ICN-2S39-N	30	1.14	15	0.25-0.12		N		
				ICN-2S39-T	29	1.13	15	0.25-0.11		T		
2	120-277	PS	Centium	ICN-2S24-N	54-53	1.04	10	0.45-0.19	0/-18	N	74	
				ICN-2S24-T	52	1.00	10	0.44-0.19		T		
				ICN-2S39-N	59-58	1.14	10	0.49-0.22		N		
				ICN-2S39-T	57	1.12	10	0.48-0.21		T		
F39T5/HO (39W)												
1	120-277	PS	Centium	ICN-2S24-N	41	0.96	15	0.34-0.15	0/-18	N	73	
				ICN-2S24-T	40	0.90	10	0.33-0.15		T		
				ICN-2S39-N	43	1.00	15	0.36-0.16		N		
				ICN-2S39-T	44	1.02	10	0.37-0.16		T		
2	120-277	PS	Centium	ICN-2S39-N	85-83	1.00	10	0.71-0.30	0/-18	N	74	
				ICN-2S39-T	86-85	1.00	10	0.72-0.31		T		
F54T5/HO (44W)												
1	120-277	PS	Centium	ICN-2S54-N	52	1.07	15	0.44-0.20	5/-15	N	73	
				ICN-2S54-T	50	1.04	10	0.42-0.18		T		
				ICN-2S54-90C-N	52	1.07	15	0.44-0.20		N		
				ICN-2S54-90C-T	50	1.04	10	0.42-0.18		T		
	347-480		Optanium	IOP-2PSP54-SC	46	1.00	10	0.39-0.18		B	77	
				IOP-2PSP49-HL-SC	55	1.17	10	0.49-0.21				
347-480	Centium	HCN-2S54-90C-WL	54	1.00	10	0.16-0.12	L	73				
		Optanium	HOP-2PSP54-L	53	1.00	10	0.15-0.11					
347-480	Optanium	HOP-2PSP49-HL-L	59	1.17	10	0.17-0.13		77				
2	120-277	PS	Centium	ICN-2S54-N	101	1.05	10	0.84-0.37	5/-15	N	74	
				ICN-2S54-T	98	1.00	10	0.83-0.36		T		
				ICN-2S54-90C-N	101	1.05	10	0.84-0.37		N		
				ICN-2S54-90C-T	98	1.00	10	0.83-0.36		T		
	347-480		Optanium	IOP-2PSP54-SC	91	1.00	10	0.77-0.34		B	78	
				IOP-2PSP49-HL-SC	111-109	1.17	10	0.97-0.41				
			347-480	Centium	HCN-2S54-90C-WL	102	1.00	10		0.30-0.22	L	74
					Optanium	HOP-2PSP54-L	98	1.00		10	0.28-0.21	
347-480	Optanium	HOP-2PSP49-HL-L	116-115	1.17	10	0.33-0.24		78				
3	120-277	PS	Centium	ICN-4S54-90C-2LS-G	149	1.00	10	1.25-0.54	5/-15	G	75A	
				Optanium	IOP-4PSP54-2LS-G	142-140	1.00	10			1.18-0.52	80
					IOP-4PSP49-HL-G	172-169	1.17	10			1.47-0.63	81
	347-480		Centium	HCN-4S54-90C-2LS-G	152	1.00	10	0.44-0.32			75A	
				Optanium	HOP-4PSP54-2LS-G	145	1.00	10			0.42-0.31	80
					HOP-4PSP49-HL-G	173-171	1.17	10			0.50-0.37	81
4	120-277	PS	Centium	ICN-4S54-90C-2LS-G	200-197	1.00	10	1.66-0.71	5/-15	G	75	
				Optanium	IOP-4PSP54-2LS-G	185-182	1.00	10			1.55-0.67	79
					IOP-4PSP49-HL-G	231-225	1.17	10			1.95-0.84	82
	347-480		Centium	HCN-4S54-90C-2LS-G	200	1.00	10	0.58-0.42			75	
				Optanium	HOP-4PSP54-2LS-G	192-191	1.00	10			0.56-0.41	79
					HOP-4PSP49-HL-G	234-228	1.17	10			0.67-0.49	82

Refer to page 3-36 to 3-38 for dimensions and wiring diagrams
Refer to pages 9-24 to 9-28 for lead lengths and shipping data

For 49W T5HO Lamps

HIGH POWER FACTOR SOUND RATED A



No. of Lamps	Input Volts	Lamp Starting Method	Ballast Family	Catalog Number	Input Power ANSI (Watts)	Ballast Factor	Max. THD %	Line Current (Amps)	Min. Starting Temp. (°F/°C)	Dim.	Wiring Dia.	
F54T5/HO (49W)												
1	120-277	PS	Centium	ICN-2S54-N	60	1.10	15	0.50-0.22	-20/-29	N	73	
				ICN-2S54-T	57	1.04	10	0.48-0.21		T		
				ICN-2S54-90C-N	60	1.10	15	0.50-0.22		N		
				ICN-2S54-90C-T	57	1.04	10	0.48-0.21		T		
	347-480		Optanium	IOP-2PSP54-SC	57	1.00	10	0.47-0.21		B	77	
				IOP-2PSP49-HL-SC	62	1.17	10	0.53-0.23				
			Centium	HCN-2S54-90C-WL	58	1.02	10	0.18-0.13		L	73	
				HOP-2PSP54-L	54-51	1.00	10	0.16-0.10			77	
			Optanium	HOP-2PSP49-HL-L	64	1.17	10	0.19-0.14				
2	120-277	PS	Centium	ICN-2S54-N	110	1.04	10	0.93-0.40	-20/-29	N	74	
				ICN-2S54-T	107-104	1.00	10	0.90-0.38		T		
				ICN-2S54-90C-N	110	1.04	10	0.93-0.40		N		
				ICN-2S54-90C-T	107-104	1.00	10	0.90-0.38		T		
	347-480		Optanium	IOP-2PSP54-SC	109-105	1.00	10	0.91-0.38		B	78	
				IOP-2PSP49-HL-SC	123-118	1.17	10	1.09-0.43				
			Centium	HCN-2S54-90C-WL	112-109	1.00	10	0.35-0.25		L	74	
				HOP-2PSP54-L	106-100	1.00	10	0.32-0.20			78	
			Optanium	HOP-2PSP49-HL-L	127-126	1.17	10	0.38-0.27				
3	120-277	PS	Centium	ICN-4S54-90C-2LS-G	168-165	1.00	10	1.52-0.66	-20/-29	G	75A	
				Optanium	IOP-4PSP54-2LS-G	162-159	1.00	10			1.35-0.58	80
					IOP-4PSP49-HL-G	190-186	1.17	10			1.58-0.69	81
	347-480		Centium	HCN-4S54-90C-2LS-G	175-172	1.00	10	0.54-0.39			75A	
				Optanium	HOP-4PSP54-2LS-G	160-154	1.00	10			0.47-0.32	80
					HOP-4PSP49-HL-G	192-188	1.17	10			0.55-0.40	81
4	120-277	PS	Centium	ICN-4S54-90C-2LS-G	222-216	1.00	10	2.00-0.86	-20/-29	G	75	
				Optanium	IOP-4PSP54-2LS-G	224-208	1.00	10			1.79-0.76	79
					IOP-4PSP49-HL-G	252-246	1.17	10			2.11-0.91	82
	347-480		Centium	HCN-4S54-90C-2LS-G	223-221	1.00	10	0.69-0.50			75	
				Optanium	HOP-4PSP54-2LS-G	214-206	1.00	10			0.62-0.43	79
					HOP-4PSP49-HL-G	255-250	1.17	10			0.72-0.52	82

Refer to page 3-36 to 3-38 for dimensions and wiring diagrams.
Refer to pages 9-24 to 9-28 for lead lengths and shipping data.

For 54-80W T5HO Lamps

HIGH POWER FACTOR SOUND RATED A



No. of Lamps	Input Volts	Lamp Starting Method	Ballast Family	Catalog Number	Input Power ANSI (Watts)	Ballast Factor	Max. THD %	Line Current (Amps)	Min. Starting Temp. (°F/°C)	Dim.	Wiring Dia.
F54T5/HO (54W)											
1	120-277	PS	Centium	ICN-2S54-N	62	1.02	10	0.52-0.23	-20/-29	N	73
				ICN-2S54-T	62	1.04	10	0.53-0.23		T	
				ICN-2S54-90C-N	62	1.02	10	0.52-0.23		N	
	ICN-2S54-90C-T			62	1.04	10	0.53-0.23	T			
	347-480		Optanium	IOP-2PSP54-SC	60	1.00	10	0.50 - 0.22		B	77
			Centium	HCN-2S54-90C-WL	62	1.02	10	0.18-0.13		L	73
2	120-277	PS	Centium	ICN-2S54-N	120-116	1.00	10	1.00-0.43	-20/-29	N	74
				ICN-2S54-T	118-115	1.00	10	0.98-0.42		T	
				ICN-2S54-90C-N	120-116	1.00	10	1.00-0.43		N	
	ICN-2S54-90C-T			118-115	1.00	10	0.98-0.42	T			
	347-480		Optanium	IOP-2PSP54-SC	117-114	1.00	10	0.98 - 0.41		B	78
			Centium	HCN-2S54-90C-WL	120-119	1.00	10	0.35-0.25		L	74
3	120-277	PS	Centium	ICN-4S54-90C-2LS-G	182-179	1.00	10	1.52-0.66	-20/-29	G	75A
			Optanium	IOP-4PSP54-2LS-G	176-174	1.00	10	1.47-0.83			80
	347-480		Centium	HCN-4S54-90C-2LS-G	188-186	1.04	10	0.54-0.39			75A
			Optanium	HOP-4PSP54-2LS-G	180-174	1.00	10	0.53-0.36			80
4	120-277	PS	Centium	ICN-4S54-90C-2LS-G	240-234	1.00	10	2.00-0.86	-20/-29	G	75
			Optanium	IOP-4PSP54-2LS-G	235-229	1.00	10	1.96-0.83			79
	347-480		Centium	HCN-4S54-90C-2LS-G	239-237	1.00	10	0.69-0.50			75
			Optanium	HOP-4PSP54-2LS-G	240-234	1.00	10	0.70-0.48			79
F80T5/HO (80W)											
1	120-277	PS	Centium	ICN-1S80-T	90-88	1.00	10	0.74-0.32	0/-18	T	73

Refer to page 3-36 to 3-38 for dimensions and wiring diagrams.
Refer to pages 9-24 to 9-28 for lead lengths and shipping data.

T5 and T5HO wiring diagrams

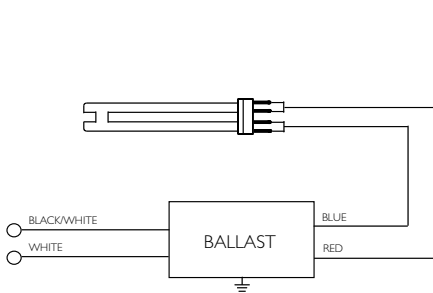

Diag. 70

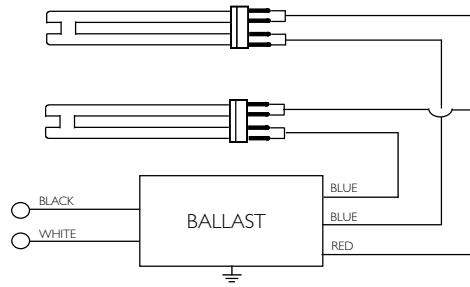

Diag. 71

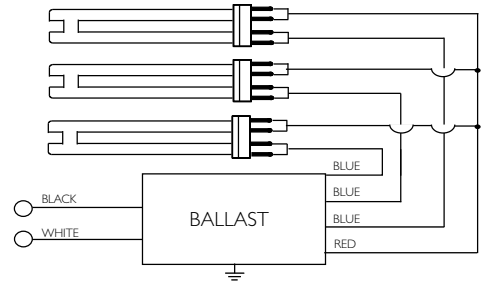

Diag. 72

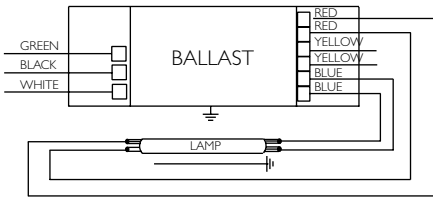

Diag. 73

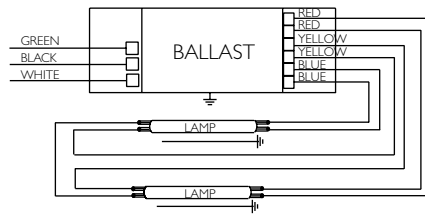

Diag. 74

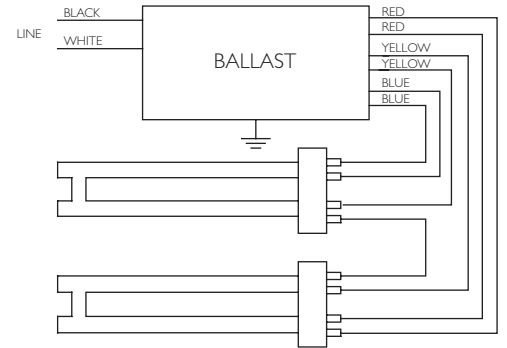

Diag. 74A

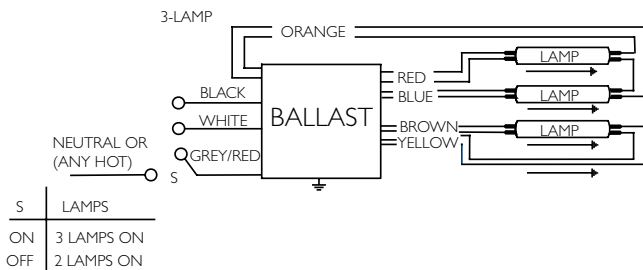

Diag. 75A

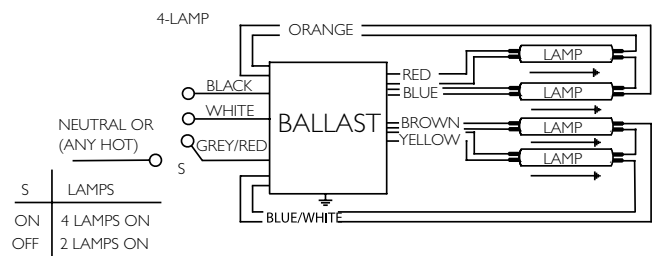

Diag. 75

T5 and T5HO wiring diagrams

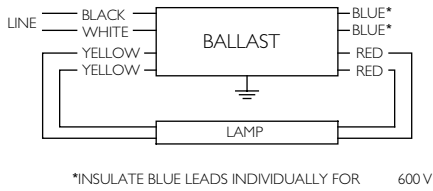

Diag. 77

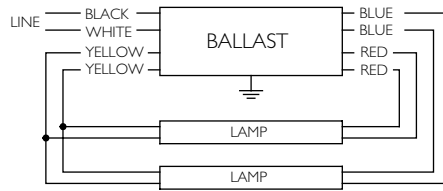

Diag. 78

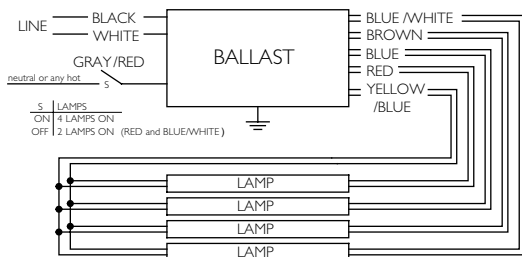

Diag. 79

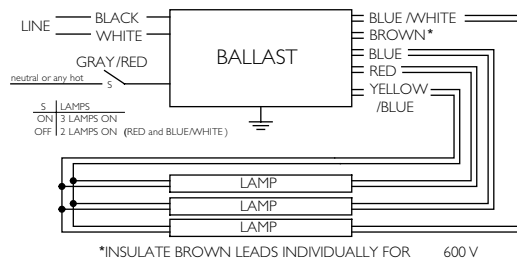

Diag. 80

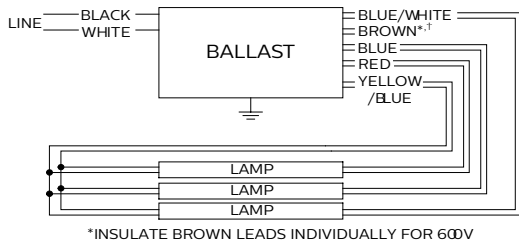

Diag. 81

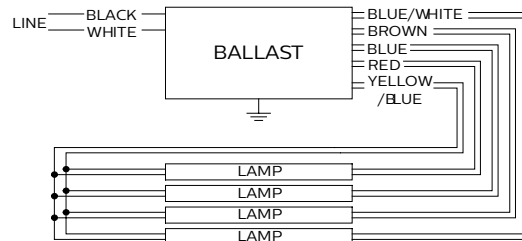

Diag. 82

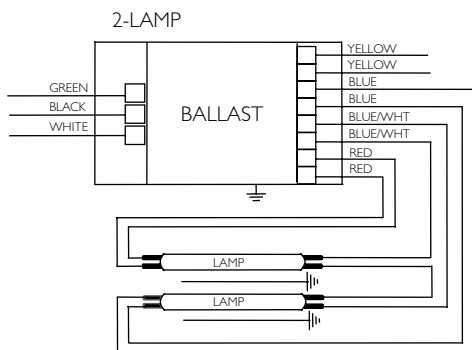

Diag. 172

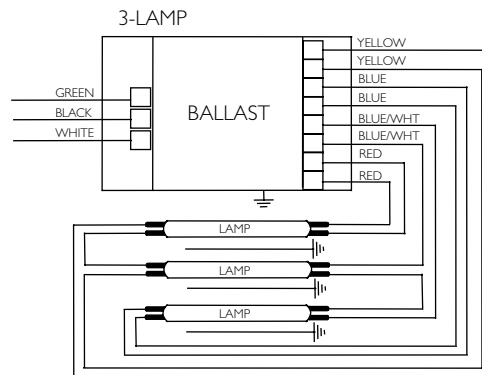

Diag. 171

T5 and T5HO dimensions

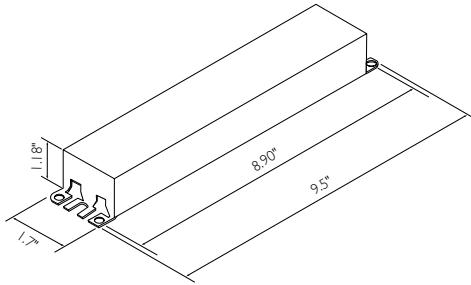

Fig. B

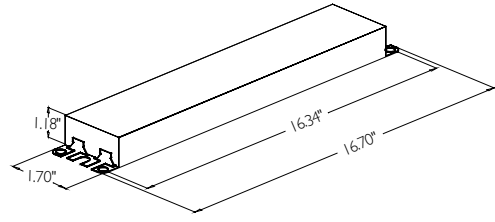

Fig. G

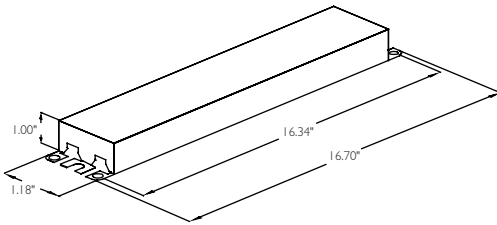

Fig. L

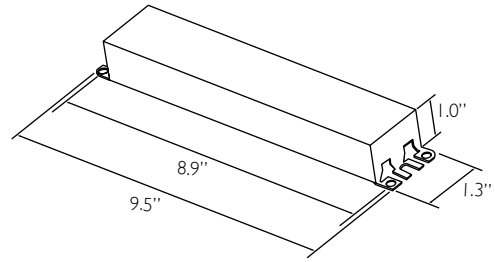

Fig. N

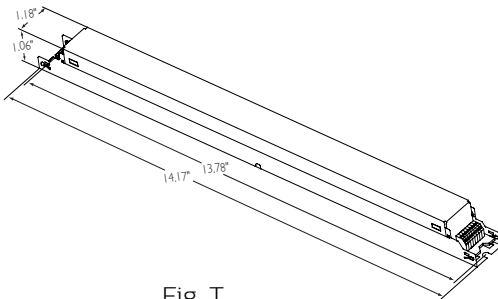
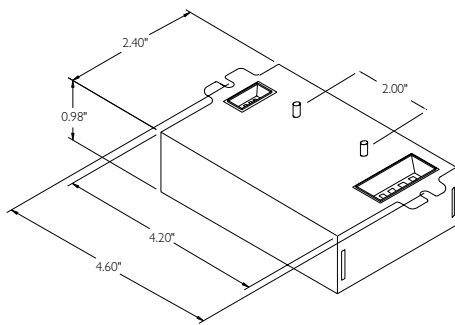
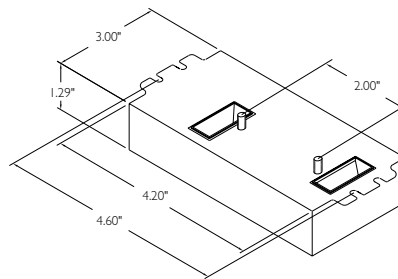

Fig. T

Includes connectors with no leads



Size 1



Size 2

For 17W T8 Lamps

HIGH POWER FACTOR SOUND RATED A



No. of Lamps	Input Volts	Lamp Starting Method	Ballast Family	Catalog Number	Input Power ANSI (Watts)	Ballast Factor	Max. THD %	Line Current (Amps)	Min. Starting Temp. (°F/°C)	Dim.	Wiring Dia.		
F17T8, FBO16T8 (17W)													
1	120-277		Centium	ICN-132-MC	17	0.88	20	0.14-0.06	0/-18	A2	63		
				ICN-1P32-N	19	0.93	15	0.16-0.07		N			
				ICN-2P32-N	22	1.07	15	0.18-0.09					
			IS	Optanium	IOP-1P32-LW-N	15	0.80	10	0.13-0.06	-20/-29	N	63	
					IOPA-1P32-LW-N								
					IOP-1P32-N	16	0.90	10	0.14-0.07				
					IOPA-1P32-N								
					IOP-1P32-HL-N	22	1.23	10	0.19-0.08				
					IOPA-1P32-HL-N								
				PS	Optanium	IOP-2P32-LW-N	18	0.90	20	0.15-0.07	0/-18	N	*64
						IOPA-2P32-LW-N							
						IOP-2P32-N	19	1.06	15	0.17-0.08			
					IOPA-2P32-N								
					IOP-2P32-HL-N	25	1.42	20	0.21-0.10				
					IOPA-2P32HL-N								
			Optanium	IOP-1PSP32-LW-N	14	0.79	10	0.12-0.05	0/-18	N	20		
				IOP-1PSP32-N	16	0.97	10	0.14-0.07					
				IOP-2PSP32-LW-N	16	0.79	10	0.13-0.06					
	IOP-2PSP32-N	19		1.00	10	0.16-0.07							
	IOP-2PSP32-HL-N	39		1.34	10	0.20-0.11							
													39
	347	IS	Optanium	GOPA-1P32-LW-SC	15	0.80	10	-20/-29	B	63			
				GOPA-1P32-SC	16	0.93							
				GOPA-2P32-LW-SC	17	0.89							
				GOPA-2P32-SC	20	1.07							
				GOP-2PSP32-LW-SC	20	0.78							
				GOP-2PSP32-SC	19	1.08							
347-480	PS	Optanium	HOP-2PSP32-HL-L	40	1.30	10	0.12-0.10	0/-18	L	77			

‡ The above AmbiStar ballasts are normal power factor and labeled 'For Residential Use Only.'

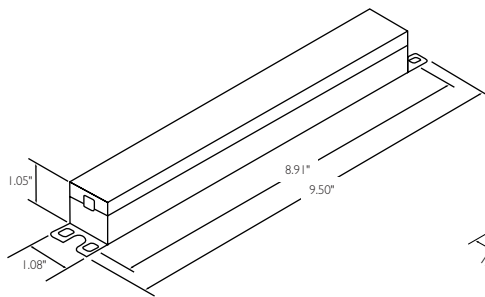

Fig. A2

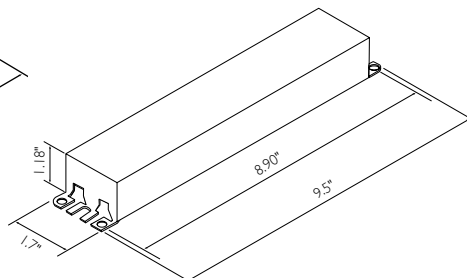

Fig. B

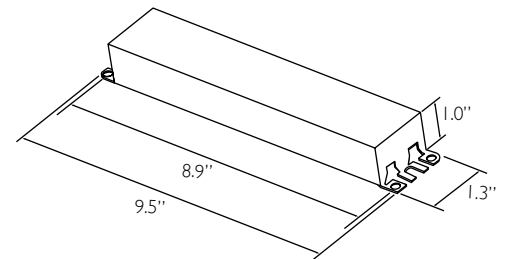

Fig. N

Refer to page 3-41 and 3-42 for wiring diagrams.
 Refer to pages 9-24 to 9-28 for lead lengths and shipping data.

For 17W T8 Lamps

HIGH POWER FACTOR SOUND RATED A



No. of Lamps	Input Volts	Lamp Starting Method	Ballast Family	Catalog Number	Input Power ANSI (Watts)	Ballast Factor	Max. THD %	Line Current (Amps)	Min. Starting Temp. (°F/°C)	Dim.	Wiring Dia.	
F17T8, FBO16T8 (17W)												
2	120	IS	AmbiStar [†]	REB-2P32-N	31	0.91	157	0.52	0/-18	N	64	
			Centium	ICN-2M32-MC	31	0.88	10	0.26-0.11	0/-18	A2	64	
				ICN-2P32-N	33	0.93	15	0.28-0.13		N	*65	
	ICN-3P32-N	38		1.07	15	0.32-0.14						
	120-277	IS	Optanium	IOP-2P32-LW-N	27	0.80	10	0.23-0.10	-20/-29	N	64	
				IOPA-2P32-LW-N								
				IOP-2P32-N	31	0.90	10	0.26-0.11				
				IOPA-2P32-N								
				IOP-2P32-HL-N	41	1.23	15	0.34-0.15				
				IOPA-2P32-HL-N								
				IOP-3P32-LW-N	31	0.87	20	0.26-0.12				
				IOPA-3P32-LW-N								
				IOP-3P32-N	35	1.01	15	0.30-0.14				
			IOPA-3P32-N									
			IOP-3P32-HL-N	47	1.37	10-30	0.39-0.20					
			IOPA-3P32-HL-N									
			PS	IOP-2PSP32-LW-N	25-24	0.71	10	0.20-0.09	0/-18	N	21	
				IOP-2PSP32-N	30	0.88	10	0.25-0.11				
				IOP-2PSP32-HL-N	66-64	1.17	10	0.33-0.15				
	IOP-3PSP32-LW-SC	30-31		0.83	15	0.25-0.12	0/-18	B				*178
	IOP-3PSP32-SC	37		1.10	15	0.31-0.14						
	IOP-3PSP32-HL-SC	48		1.35	10	0.40-0.18						
	347	IS	Optanium	GOPA-2P32-LW-SC	27	0.78	10	0.08	-20/-29	B	64	
				GOPA-2P32-SC	30	0.88		0.09				
GOPA-3P32-LW-SC				30	0.87	0.09		*65				
GOPA-3P32-SC		34		1.01	0.10							
GOP-2PSP32-LW-SC		30		0.71	0.09	0/-18					B	21
GOP-2PSP32-SC		31		0.88	0.09							
HOP-2PSP32-HL-L	67	1.20	0.21-0.15									
347-480	PS								L			

[†] The above AmbiStar ballasts are normal power factor and labeled 'For Residential Use Only'

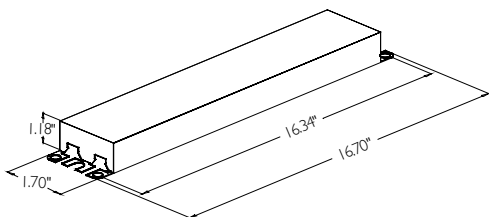

Fig. G

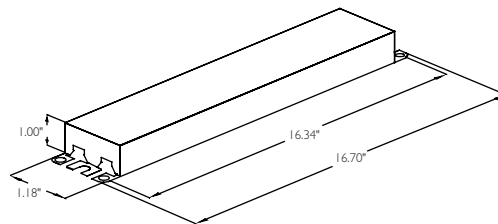

Fig. L

Refer to page 3-39 for additional dimensions.
 Refer to page 3-41 and 3-42 for wiring diagrams.
 Refer to pages 9-24 to 9-28 for lead lengths and shipping data.

For 17W T8 Lamps

HIGH POWER FACTOR SOUND RATED A



No. of Lamps	Input Volts	Lamp Starting Method	Ballast Family	Catalog Number	Input Power ANSI (Watts)	Ballast Factor	Max. THD %	Line Current (Amps)	Min. Starting Temp. (°F/°C)	Dim.	Wiring Dia.					
F17T8, FBO16T8 (17W)																
3	120	IS	AmbiStar [†]	REB-4P32-SC	44	0.81	135	0.87	0/-18	B	*66					
			Centium	ICN-3P32-N	48	0.92	15	0.39-0.17	0/-18	N	65					
	ICN-4P32-N	53		1.04	15	0.45-0.20	*66									
	120-277	IS	Optanium	IOP-3P32-LW-N	40	0.81	10	0.34-0.15	-20/-29	N	65					
				IOPA-3P32-LW-N												
				IOP-3P32-N	45	0.90	10	0.38-0.17								
				IOPA-3P32-N												
				IOP-3P32-HL-N	59	1.22	10-15	0.49-0.22								
				IOPA-3P32-HL-N												
			IOP-4P32-LW-N	43	0.85	20	0.36-0.17									
			IOPA-4P32-LW-N													
			IOP-4P32-N	49	1.00	15	0.41-0.18									
			IOPA-4P32-N													
			IOP-4P32-HL-SC	69	1.28	10	0.58-0.26									
			IOPA-4P32-HL-90C-SC													
	PS	PS	Optanium	IOP-3PSP32-LW-SC	39	0.72	10	0.33-0.15	0/-18	B	178					
				IOP-3PSP32-SC	47	0.90	10	0.39-0.17								
				IOP-3PSP32-HL-SC	62	1.22	10	0.52-0.23								
				IOP-4PSP32-LW-SC	40	0.81	10	0.34-0.15								
				IOP-4PSP32-SC	47	1.00	10	0.40-0.18								
				IOP-4PSP32-HL-G	69	1.35	10	0.57-0.26								
				347	IS	Optanium	GOPA-3P32-LW-SC	39		0.81		10	0.12	-20/-29	B	65
							GOPA-3P32-SC	44		0.92			0.13			
	GOPA-4P32-LW-SC	45	0.82				0.13									
GOPA-4P32-SC	50	1.00	0.15				*66									
GOP-3PSP32-SC	46	0.88	0.14													
GOP-4PSP32-LW-SC	46	0.74	0.14													
347-480	PS	Optanium	GOP-4PSP32-SC	46	0.93	10	0.14	0/-18	G	178						
			HOP-4PSP32-HL-G	69	1.32		0.21-0.15									

[†] The above AmbiStar ballasts are normal power factor and labeled 'For Residential Use Only'

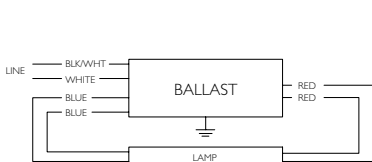

Diag. 20

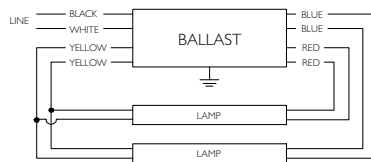

Diag. 21

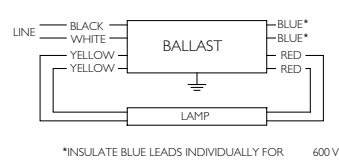

Diag. 77

Refer to page 3-39 and 3-40 for dimensions.
 Refer to page 3-42 for additional wiring diagrams.
 Refer to pages 9-24 to 9-28 for lead lengths and shipping data.

For 17W T8 Lamps

HIGH POWER FACTOR SOUND RATED A



No. of Lamps	Input Volts	Lamp Starting Method	Ballast Family	Catalog Number	Input Power ANSI (Watts)	Ballast Factor	Max. THD %	Line Current (Amps)	Min. Starting Temp. (°F/°C)	Dim.	Wiring Dia.
F17T8, FBO16T8 (17W)											
4	120	IS	AmbiStar [†]	REB-4P32-SC	52	0.82	135	1.00	0/-18	B	66
			Centium	ICN-4P32-N	64	0.93	10	0.54-0.23	0/-18	N	66
	120-277	IS	Optanium	IOP-4P32-LW-N	53	0.81	10	0.45-0.20	-20/-29	N	
				IOPA-4P32-LW-N							
				IOP-4P32-N	58	0.90	10	0.49-0.22		N	
				IOPA-4P32-N							
				IOP-4P32-HL-SC	80	1.22	10	0.67-0.30		B	
				IOP-4P32-HL-90C-SC							
	PS	IOP-4PSP32-LW-SC	54	0.76	10	0.45-0.20	0/-18	B	177		
		IOP-4PSP32-SC	60	0.90	10	0.50-0.22		G			
		IOP-4PSP32-HL-G	82	1.24	10	0.68-0.29	0/-18	G			
	347	IS	Optanium	GOPA-4P32-LW-SC	53	0.79	10	0.16	-20/-29	B	66
				GOPA-4P32-SC	60	0.93		0.17			
	347-480	PS	Optanium	GOP-4PSP32-LW-SC	54	0.71	10	0.16	0/-18	B	177
				GOP-4PSP32-SC	54	0.88		0.16			
HOP-4PSP32-HL-G				82	1.22	0.24-0.18					

[†] The above AmbiStar ballasts are normal power factor and labeled 'For Residential Use Only'

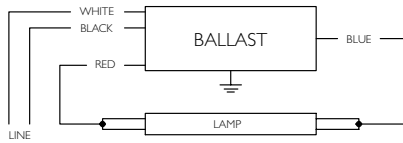

Diag. 63

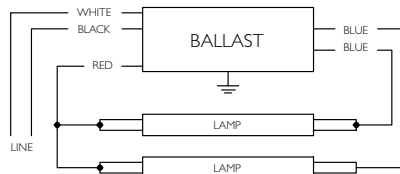

*FOR SINGLE LAMP OPERATION, INSULATE UNUSED BLUE LEAD FOR 600V
Diag. 64

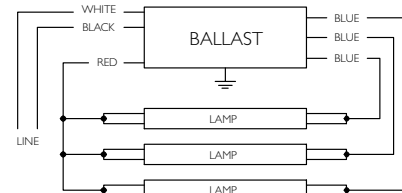

*FOR TWO LAMP OPERATION, INSULATE UNUSED BLUE LEADS INDIVIDUALLY FOR 600V
Diag. 65

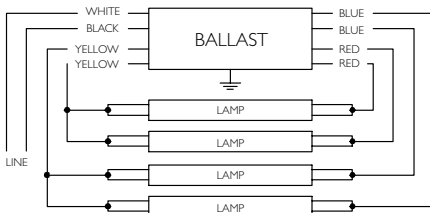

*FOR THREE LAMP OPERATION, INSULATE UNUSED BLUE LEADS INDIVIDUALLY FOR 600V
Diag. 66

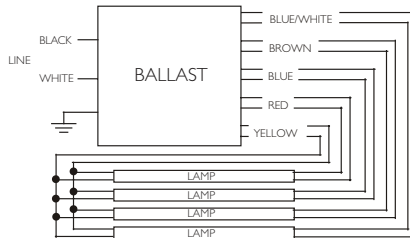

Diag. 177

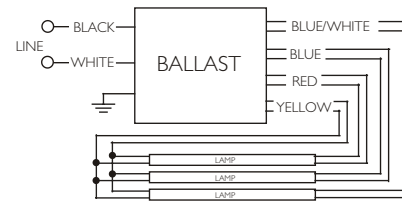

*INSULATE UNUSED LEADS INDIVIDUALLY FOR 600V
Diag. 178

Refer to page 3-39 and 3-40 for dimensions.
Refer to pages 9-24 to 9-28 for lead lengths and shipping data.

For 25W-36" T8 Lamps

HIGH POWER FACTOR SOUND RATED A



No. of Lamps	Input Volts	Lamp Starting Method	Ballast Family	Catalog Number	Input Power ANSI (Watts)	Ballast Factor	Max. THD %	Line Current (Amps)	Min. Starting Temp. (°F/°C)	Dim.	Wiring Dia.	
F25T8, FBO24T8 (25W - 36")												
1	120	IS	AmbiStar [†]	REB-2P32-N	25	1.02	162	0.48	0/-18	N	*64	
	120-277	IS	Centium	ICN-132-MC	23	0.88	15	0.19-0.09	0/-18	A2	63	
				ICN-1P32-N	26	0.91	10	0.22-0.10		N		*64
				ICN-2P32-N	29	1.06	15	0.24-0.11			-20/-29	N
				IOP-1P32-LW-N	21	0.78	10	0.17-0.08				
			IOPA-1P32-LW -N									
			IOP-1P32-N	23	0.88	10	0.20-0.09					
			IOPA-1P32-N									
			IOP-1P32-HL-N	30	1.22	10	0.26-0.11	N				
			IOPA-1P32-HL-N									
		IOP-2P32-LW-N	24	0.90	10	0.20-0.09	N	*64				
		IOPA-2P32-LW-N										
		IOP-2P32-N	28	1.05	10	0.23-0.10						
		IOPA-2P32-N										
		IOP-2P32-HL-N										
		IOPA-2P32-HL-N	35	1.40	20	0.29-0.13						
		IOPA-2P32-HL-N										
		PS	IS	Optanium	IOP-1PSP32-LW-N	20	0.74	10	0.16-0.07	0/-18	N	20
					IOP-1PSP32-N	22	0.92	10	0.19-0.08			
	IOP-2PSP32-LW-N				21	0.77	10	0.17-0.08				
	IOP-2PSP32-N				25	0.97	10	0.21-0.10				
	IOP-2PSP32-HL-N				35	1.35	10	0.29-0.13				
	IOP-2PSP32-HL-N				35	1.35	10	0.29-0.13				
	347	IS	Optanium	GOPA-1P32-LW-SC	20	0.80	10	0.07	-20/-29	B	63	
				GOPA-1P32-SC	22	0.91		0.07				
				GOPA-2P32-LW-SC	24	0.88		0.08				
				GOPA-2P32-SC	27	1.05		0.08				
GOP-2PSP32-LW-SC		26		0.77	0.08	0/-18		77				
GOP-2PSP32-N		26		1.05	0.08							
GOP-2PSP32-SC		26		1.05	0.08							
GOP-2PSP32-SC		26		1.05	0.08							
347-480	PS		HOP-2PSP32-HL-L	35	1.30		0.11-0.09		L			

[†] The above AmbiStar ballasts are normal power factor and labeled 'For Residential Use Only.'

Refer to page 3-39 and 3-40 for dimensions.
 Refer to page 3-41 and 3-42 for wiring diagrams.
 Refer to pages 9-24 to 9-28 for lead lengths and shipping data.

For 25W-36" T8 Lamps

HIGH POWER FACTOR SOUND RATED A



No. of Lamps	Input Volts	Lamp Starting Method	Ballast Family	Catalog Number	Input Power ANSI (Watts)	Ballast Factor	Max. THD %	Line Current (Amps)	Min. Starting Temp. (°F/°C)	Dim.	Wiring Dia.
F25T8, FBO24T8 (25W - 36")											
2	120-277	IS	AmbiStar [†]	REB-2P32-N	44	0.88	148	0.70	0/-18	N	64
			Centium	ICN-2M32-MC	44	0.88	15	0.37-0.16		A2	64
				ICN-2P32-N	48	0.91	10	0.40-0.18		N	*65
				ICN-3P32-N	51	1.03	15	0.43-0.19			
			Optanium	IOP-2P32-LW-N	39	0.78	10	0.32-0.14	N	64	
				IOPA-2P32-LW-N							
		IOP-2P32-N		43	0.88	10	0.37-0.16				
		IOPA-2P32-N									
		IOP-2P32-HL-N		57	1.20	10	0.48-0.21				
		IOPA-2P32-HL-N									
		PS	IOP-3P32-LW-N	43	0.86	10	0.36-0.16	-20/-29	N	*65	
			IOPA-3P32-LW-N								
	IOP-3P32-N		49	1.00	10	0.42-0.18					
	IOPA-3P32-N										
	IOP-3P32-HL-N		64	1.32	10-15	0.54-0.24					
	IOPA-3P32-HL-N										
	347	IS	Optanium	GOPA-2P32-LW-SC	38	0.78	10	0.12	-20/-29	B	64
				GOPA-2P32-SC	44	0.88		0.13			
				GOPA-3P32-LW-SC	42	0.85		0.12			*65
				GOPA-3P32-SC	48	1.01		0.14			
				GOP-2PSP32-LW-SC	41	0.71		0.12	0/-18	L	21
				GOP-2PSP32-SC	43	0.88		0.13			
	HOP-2PSP32-HL-L	59	1.20	0.18-0.13							
	347-480	PS	Optanium	IOP-2PSP32-LW-N	35-34	0.71	10	0.29-0.13	0/-18	N	21
IOP-2PSP32-N				43	0.88	10	0.36-0.16				
IOP-2PSP32-HL-N				58-57	1.16	10	0.48-0.21				
IOP-3PSP32-LW-SC				41	0.81	10	0.34-0.15	0/-18	B	*178	
IOP-3PSP32-SC				51	1.09	10	0.43-0.19				
IOP-3PSP32-HL-SC				67	1.33	10	0.56-0.25				

[†] The above AmbiStar ballasts are normal power factor and labeled 'For Residential Use Only.'

Refer to page 3-39 and 3-40 for dimensions.
 Refer to page 3-41 and 3-42 for wiring diagram.
 Refer to pages 9-24 to 9-28 for lead lengths and shipping data.

For 25W-36" T8 Lamps

HIGH POWER FACTOR SOUND RATED A



No. of Lamps	Input Volts	Lamp Starting Method	Ballast Family	Catalog Number	Input Power ANSI (Watts)	Ballast Factor	Max. THD %	Line Current (Amps)	Min. Starting Temp. (°F/°C)	Dim.	Wiring Dia.				
F25T8, FBO24T8 (25W - 36")															
3	120-277	IS	AmbiStar [†]	REB-4P32-SC	63	0.86	125	1.14	0/-18	B	*66				
			Centium	ICN-3P32-N	67	0.90	10	0.56-0.24		N	65				
				ICN-4P32-N	74	1.01	10	0.62-0.27		N	*66				
		IS	Optanium	IOP-3P32-LW-N	57	0.79	10	0.48-0.21	-20/-29	N	65				
				IOPA-3P32-LW-N											
				IOP-3P32-N	64	0.88	10	0.54-0.24		N					
				IOPA-3P32-N											
				IOP-3P32-HL-N	84	1.20	10	0.70-0.31		N					
				IOP-3P32-HL-90C-N											
			IOPA-3P32-HL-N												
			IOP-4P32-LW-N	62					0.85	10	0.52-0.22	N			
			IOPA-4P32-LW-N												
			Optanium	IOP-4P32-N	71	0.97	10	0.59-0.26	N	*66					
				IOPA-4P32-N											
				IOP-4P32-HL-SC	94	1.28	10	0.80-0.35	B						
		IOP-4P32-HL-90C-SC													
		PS		IOP-3PSP32-LW-SC	57	0.72	10	0.48-0.21	0/-18		B	178			
				IOP-3PSP32-SC	66	0.89	10	0.55-0.24							
	IOP-3PSP32-HL-SC		88	1.20	10	0.73-0.32									
	IOP-4PSP32-LW-SC		56	0.80	10	0.47-0.21									
	IOP-4PSP32-SC		65	0.99	10	0.55-0.24									
	IOP-4PSP32-HL-G		96	1.32	10	0.80-0.35	G								
	347		IS	Optanium	GOPA-3P32-LW-SC	56	0.77	10		0.16			-20/-29	B	65
		GOPA-3P32-SC			63	0.90	10	0.18							
		GOPA-4P32-LW-SC			62	0.81	10	0.18							
		GOPA-4P32-SC			70	0.96	10	0.20							
		GOP-3PSP32-SC			67	0.88	10	0.20							
GOP-4PSP32-LW-SC		65			0.74	10	0.19								
PS		GOP-4PSP32-SC	66	0.93	10	0.19	0/-18	B	178						
		HOP-4PSP32-HL-G	96	1.30	10	0.29-0.21									
		347-480	IS	Optanium	GOPA-3P32-LW-SC	56				0.77	10	0.16	-20/-29	B	65
					GOPA-3P32-SC	63				0.90	10	0.18			
347-480	PS	Optanium	GOP-3PSP32-SC	67	0.88	10	0.20	0/-18	B	178					
			GOP-4PSP32-LW-SC	65	0.74	10	0.19								
347-480	PS	Optanium	GOP-4PSP32-SC	66	0.93	10	0.19	0/-18	B	178					
			HOP-4PSP32-HL-G	96	1.30	10	0.29-0.21								

† The above AmbiStar ballasts are normal power factor and labeled 'For Residential Use Only.'

Refer to page 3-39 and 3-40 for dimensions.
 Refer to page 3-41 and 3-42 for wiring diagrams.
 Refer to pages 9-24 to 9-28 for lead lengths and shipping data.

For 25W-36" T8 Lamps

HIGH POWER FACTOR SOUND RATED A



No. of Lamps	Input Volts	Lamp Starting Method	Ballast Family	Catalog Number	Input Power ANSI (Watts)	Ballast Factor	Max. THD %	Line Current (Amps)	Min. Starting Temp. (°F/°C)	Dim.	Wiring Dia.	
F25T8, FBO24T8 (25W - 36")												
4	120	IS	AmbiStar [†]	REB-4P32-SC	77	0.81	125	1.31	0/-18	B	66	
			Centium	ICN-4P32-N	89	0.91	10	0.74-0.32		N		
	120-277	IS	Optanium		IOP-4P32-LW-N	76	0.79	10	0.64-0.27	-20/-29	N	66
					IOPA-4P32-LW-N							
					IOP-4P32-N	85	0.88	10	0.72-0.31		N	
					IOPA-4P32-N							
					IOP-4P32-HL-SC	113	1.20	10	0.96-0.41		B	
					IOP-4P32-HL-90C-SC							
	PS	PS	Optanium		IOP-4PSP32-LW-SC	73	0.72	10	0.62-0.27	0/-18	B	177
					IOP-4PSP32-SC	85	0.90	10	0.71-0.31		G	
					IOP-4PSP32-HL-G	115	1.22	10	0.96-0.42			
	347	IS	Optanium		GOPA-4P32-LW-SC	74	0.79	10	0.22	-20/-29	B	66
					GOPA-4P32-SC	86	0.91	10	0.25			
		PS			GOP-4PSP32-LW-SC	75	0.71	10	0.22	0/-18	G	177
					GOP-4PSP32-SC	80	0.88	10	0.23			
347-480				HOP-4PSP32-HL-G	115	1.20	10	0.34-0.25				

[†] The above AmbiStar ballasts are normal power factor and labeled 'For Residential Use Only.'

Refer to page 3-39 and 3-40 for dimensions.
 Refer to page 3-41 and 3-42 for wiring diagrams.
 Refer to pages 9-24 to 9-28 for lead lengths and shipping data.

For 25W-48" T8/ES Lamps

HIGH POWER FACTOR SOUND RATED A



No. of Lamps		Ballast Family	Catalog Number	Input Power ANSI (Watts)		Max. THD %		Min. Starting Temp. (°F/°C)	Dim.				
F32T8/ES (25W - 48")													
1	120-277	Centium	ICN-1P32-N	23	0.91	10	0.19-0.09	60/16	N	63			
			ICN-2P32-N	28-27	1.05	10	0.24-0.10			*64			
		IS	IOP-1P32-LW-N	IOPA-1P32-LW-N	21	0.77	10		0.17-0.07	N	63		
												IOP-1P32-N	23
			IOP-1P32-HL-N	31	1.17	10	0.25-.012						
			IOPA-1P32-HL-N						24	0.90		10	0.20-0.09
			IOP-2P32-LW-N	27	1.05	10	0.23-0.10						
			IOPA-2P32-N						37	1.40		15	0.31-0.14
			IOP-2P32-HL-N	21	0.72	10	0.17-0.07						
			IOPA-2P32-HL-N						24	0.88		10	0.20-0.08
			IOP-2PSP32-LW-N	22	0.77	10	0.18-0.08						
			IOPA-2PSP32-N						27	0.94		10	0.23-0.10
		IOP-2PSP32-HL-N	36	1.28	10	0.30-0.14							
		347					IS		Optanium	GOPA-1P32-LW-SC	21	0.77	10
			GOPA-1P32-SC	23	0.88	0.06				*64			
			GOPA-2P32-LW-SC	25	0.88	0.07							
			PS	GOP-2PSP32-LW-SC	27	1.04	0.09			77			
				GOP-2PSP32-SC	27	0.77	0.08						
	HOP-2PSP32-HL-L			37	1.28	0.08							
	347-480						.12-0.09	L					

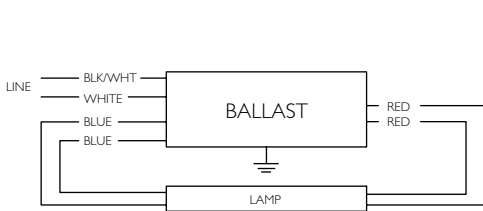

Diag. 20

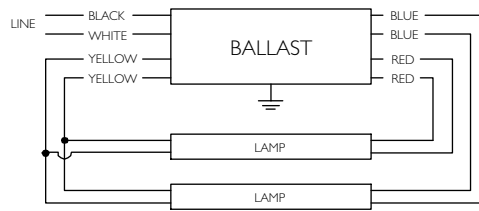

Diag. 21

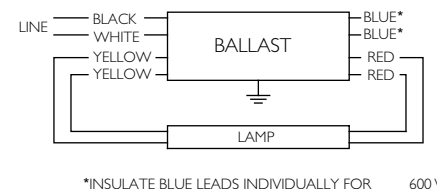

*INSULATE BLUE LEADS INDIVIDUALLY FOR 600 V

Diag. 77

Refer to page 3-39 and 3-40 for dimensions.
 Refer to page 3-48 for additional wiring diagrams.
 Refer to pages 9-24 to 9-28 for lead lengths and shipping data.

For 25W-48" T8/ES Lamps

HIGH POWER FACTOR SOUND RATED A



No. of Lamps	Input Volts	Lamp Starting Method	Ballast Family	Catalog Number	Input Power ANSI (Watts)	Ballast Factor	Max. THD %	Line Current (Amps)	Min. Starting Temp. (°F/°C)	Dim.	Wiring Dia.	
F32T8/ES (25W - 48")												
2	120-277	Centium	IS	ICN-2P32-N	45-46	0.92	10	0.38-0.16	60/16	N	64	
				ICN-3P32-N	51-50	1.00	10	0.42-0.19			*65	
				IOP-2P32-LW-N	38	0.77	10	0.32-0.14			64	
				IOPA-2P32-LW-N								
				IOP-2P32-N	44-43	0.87	10	0.37-0.06				
				IOPA-2P32-N								
		IOP-2P32-HL-N	60	1.19	10	0.50-0.22						
		IOPA-2P32-HL-N										
		IOP-3P32-LW-N	43	0.86	10	0.36-0.16						
		IOPA-3P32-LW-N										
		IOP-3P32-N	49	1.00	10	0.42-0.18						
		IOPA-3P32-N										
		IOP-3P32-HL-N	70	1.32	10-20	0.59-0.27						
		IOP-3P32-HL-90C-N										
		IOPA-3P32-HL-N										
		PS	IS	Optanium	IOP-2PSP32-LW-N	37-36	0.71	10	0.31-0.13	60/16	N	21
					IOP-2PSP32-N	46-45	0.88	10	0.39-0.17			
					IOP-2PSP32-HL-N	60-59	1.19	10	0.50-0.22			
	IOP-3PSP32-LW-SC				43	0.77	10	0.36-0.16				
	IOP-3PSP32-SC				54-53	1.05	10	0.45-0.20				
	IOP-3PSP32-HL-SC				71-70	1.35	10	0.59-0.26				
	347	IS	Optanium	GOPA-2P32-LW-SC	39	0.78	10	0.12	60/16	B	64	
				GOPA-2P32-SC	44	0.88		0.13			*65	
				GOPA-3P32-LW-SC	43	0.86		0.13				
GOPA-3P32-SC				48	1.00	0.14						
GOP-2PSP32-LW-SC				43	0.71	0.08						
GOP-2PSP32-SC				46	0.88	0.14						
347-480	PS	Optanium	GOP-2PSP32-SC	46	0.88	10	0.14	60/16	L	21		
			HOP-2PSP32-HL-L	62	1.18		0.18-0.14					

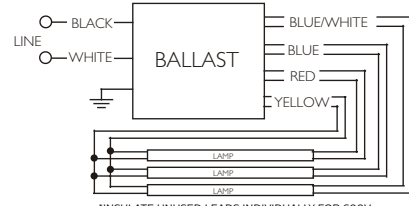
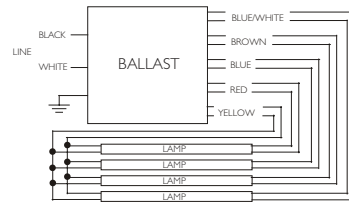
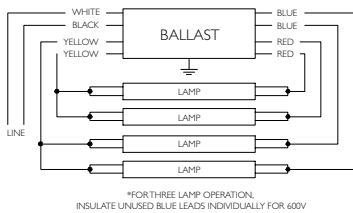
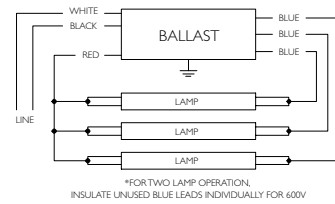
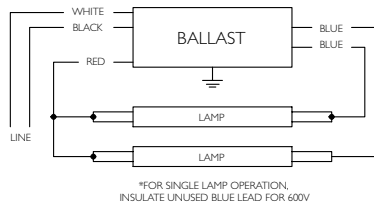
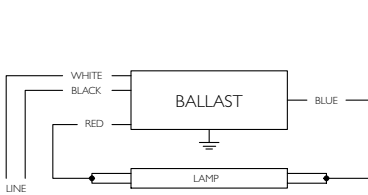

Refer to page 3-39 and 3-40 for dimensions.
 Refer to page 3-47 for additional wiring diagrams.
 Refer to pages 9-24 to 9-28 for lead lengths and shipping data.

For 25W-48" T8/ES Lamps

HIGH POWER FACTOR SOUND RATED A



No. of Lamps	Input Volts	Lamp Starting Method	Ballast Family	Catalog Number	Input Power ANSI (Watts)	Ballast Factor	Max. THD %	Line Current (Amps)	Min. Starting Temp. (°F/°C)	Dim.	Wiring Dia.			
F32T8/ES (25W - 48")														
3	120-277	IS	Centium	ICN-3P32-N	71-69	0.94	10	0.59-0.26	60/16	N	65			
				ICN-4P32-N	75-73	1.00		0.62-0.27			*66			
			Optanium	IOP-3P32-LW-N	58-57	0.77	10	0.49-0.21	N	65				
				IOPA-3P32-LW-N										
				IOP-3P32-N	65-64	0.87	10	0.55-0.24						
				IOPA-3P32-N										
				IOP-3P32-HL-N	91-90	1.20	10	0.76-0.33						
				IOPA-3P32-HL-N										
			IOP-4P32-LW-N	62-61	0.85	10	0.52-0.22	N	*66					
			IOPA-4P32-LW-N											
			PS	Optanium	IOP-4P32-N	70-69	0.97	10	0.59-0.26	60/16	N	*66		
					IOPA-4P32-N									
				IOP-4P32-HL-SC	100	1.28	10	0.85-0.37	B	178				
				IOP-4P32-HL-90C-SC										
	IOP-3PSP32-LW-SC	57		0.70	10	0.48-0.21	B	178						
	IOP-3PSP32-SC	70		0.88	10	0.58-0.26								
	IOP-3PSP32-HL-SC	92	1.18	10	0.76-0.33									
	IOP-4PSP32-LW-SC	59	0.81	10	0.50-0.22									
	IOP-4PSP32-SC	69	0.98	10	0.59-0.26									
	IOP-4PSP32-HL-G	101	1.32	10	0.84-0.37	G								
347	IS	Optanium	GOPA-3P32-SC	64	0.88	10	0.19	60/16	B	65				
			GOPA-4P32-LW-SC	65	0.81		0.19			*66				
			GOPA-4P32-SC	74	0.95		0.21			178				
			GOPA-3P32-LW-SC	58	0.77		10				0.17			
			GOP-3PSP32-SC	67	0.88		10				0.15			
			GOP-4PSP32-LW-SC	63	0.74		10				0.18			
			GOP-4PSP32-SC	69	0.93		10				0.20			
			HOP-4PSP32-HL-G	100	1.24		10				0.28-0.21	G		
347/480														
4	120-277	IS	Centium	ICN-4P32-N	91-90	0.90	10	0.76-0.33	60/16	N	66			
			Optanium	IOP-4P32-LW-N	77-75	0.77	10	0.65-0.28	60/16	N	66			
				IOPA-4P32-LW-N										
				IOP-4P32-N	87-85	0.87	10	0.73-0.31						
				IOPA-4P32-N										
				IOP-4P32-HL-SC	119-177	1.18	10	1.00-0.43				B		
				IOP-4P32-HL-90C-SC										
			PS	IOP-4PSP32-LW-SC	75	0.71	10	0.63-0.28	B	177				
	IOP-4PSP32-SC	90		0.88	10	0.75-0.33								
	IOP-4PSP32-HL-G	121-120		1.21	10	1.07-0.44	G							
	347	IS		Optanium	GOPA-4P32-LW-SC	78	0.78	10			0.22	60/16	B	66
					GOPA-4P32-SC	89	0.88				0.26			
					GOP-4PSP32-LW-SC	75	0.71				0.22			177
			GOP-4PSP32-SC		86	0.88	0.25							
347-480			HOP-4PSP32-HL-G	122	1.17		0.36-0.26	G						

Refer to page 3-39 and 3-40 for dimensions.
 Refer to page 3-48 for wiring diagrams.
 Refer to pages 9-24 to 9-28 for lead lengths and shipping data.

For 28W-48" T8/ES Lamps

HIGH POWER FACTOR SOUND RATED A



No. of Lamps	Input Volts	Lamp Starting Method	Ballast Family	Catalog Number	Input Power ANSI (Watts)	Ballast Factor	Max. THD %	Line Current (Amps)	Min. Starting Temp. (°F/°C)	Dim.	Wiring Dia.
F32T8/ES (28W - 48")											
1	120-277	IS	Centium	ICN-1P32-N	25-26	0.91	10	0.22-0.09	60/16	N	63
				ICN-2P32-N	31-30	1.03	10	0.24-0.12			*64
			Optanium	IOP-1P32-LW-N	22	0.77	10	0.19-0.08		N	63
				IOPA-1P32-LW-N							
				IOP-1P32-N	25	0.87	10	0.22-0.10		N	
				IOPA-1P32-N							
				IOP-1P32-HL-N	32	1.18	10	0.27-0.12		N	
				IOPA-1P32-HL-N							
		IOP-2P32-LW-N	26	0.90	10	0.22-0.10	N				
		IOPA-2P32-LW-N									
		PS	Optanium	IOP-1P32-N	31	1.05	10	0.26-0.11		N	*64
				IOPA-2P32-N							
			IOP-2P32-HL-N	39	1.38	10	0.33-0.15				
			IOPA-2P32-HL-N								
	Optanium		IOP-1PSP32-LW-N	21	0.72	10	0.18-0.07	N	20		
			IOP-1PSP32-N	25	0.88	10	0.20-0.09				
		IOP-2PSP32-LW-N	23	0.74	10	0.19-0.09					
		IOP-2PSP32-N	30-28	0.94	10	0.23-0.10					
	IOP-2PSP32-HL-N	39	1.28	10	0.33-0.15						
	347	IS	Optanium	GOPA-1P32-LW-SC	22	0.77	10	0.07	60/16	B	63
GOPA-1P32-SC				25	0.88	10	0.07	*64			
GOPA-2P32-LW-SC				26	0.88	10	0.08				
GOPA-2P32-SC		29		1.04	10	0.09	77				
GOP-2PSP32-LW-SC		28		0.74	10	0.08					
GOP-2PSP32-SC		30		1.03	10	0.09					
PS		HOP-2PSP32-HL-L		41	1.28	10		0.13-0.10		60/16	L
	347-480										

Refer to page 3-53 and 3-54 for dimensions.
 Refer to page 3-55 and 3-56 for wiring diagrams.
 Refer to pages 9-24 to 9-28 for lead lengths and shipping data.

For 28W-48" T8/ES Lamps

HIGH POWER FACTOR SOUND RATED A



No. of Lamps	Input Volts	Lamp Starting Method	Ballast Family	Catalog Number	Input Power ANSI (Watts)	Ballast Factor	Max. THD %	Line Current (Amps)	Min. Starting Temp. (°F/°C)	Dim.	Wiring Dia.			
F32T8/ES (28W - 48")														
2	120-277	IS	Centium	ICN-2P32-N	48-47	0.89	10	0.41-0.27	60/16	N	64			
				ICN-3P32-N	55	1.00		0.46-0.20			*65			
			Optanium	IOP-2P32-LW-N	42	0.77	10	0.35-0.15	60/16	N	64			
				IOPA-2P32-LW-N										
				IOP-2P32-N	48-47	0.87	10	0.41-0.18						
				IOPA-2P32-N										
				IOP-2P32-HL-N	65-64	1.19	10	0.55-0.24						
				IOPA-2P32-HL-N										
				IOP-3P32-LW-N	47	0.86	10	0.40-0.18						
				IOPA-3P32-LW-N										
	IOP-3P32-N	55-54	1.00	10	0.46-0.20									
	IOPA-3P32-N													
	PS	IOP-3P32-HL-N	74-73	1.31	10-15	0.62-0.27	60/16	N	*65					
		IOPA-3P32-HL-N												
		IOP-2PSP32-LW-N	39	0.71	10	0.33-0.14				N	21			
		IOP-2PSP32-N	51-49	0.88	10	0.42-0.18								
		IOP-2PSP32-HL-N	66-64	1.15	10	0.55-0.23				B	*178			
		IOP-3PSP32-LW-SC	47	0.77	10	0.39-0.17								
		IOP-3PSP32-SC	73-72	0.86	10	0.61-0.26								
		IOP-3PSP32-HL-SC	77-76	1.16	10	0.64-0.28								
347		IS	Optanium	GOPA-2P32-LW-SC	42	0.78				10	0.12	60/16	B	64
				GOPA-2P32-SC	47	0.88					0.14			*65
	GOPA-3P32-LW-SC			46	0.77	0.13	21							
	GOPA-3P32-SC			52	1.00	0.16								
	PS	GOP-2PSP32-LW-SC		45	0.71	0.13	L	21						
		GOP-2PSP32-SC		50	0.88	0.15								
		HOP-2PSP32-HL-L		69	1.16	0.20-0.15								
		347-480												

Refer to page 3-53 and 3-54 for dimensions.
 Refer to page 3-55 and 3-56 for wiring diagrams.
 Refer to pages 9-24 to 9-28 for lead lengths and shipping data.

For 28W-48" T8/ES Lamps

HIGH POWER FACTOR SOUND RATED A



No. of Lamps	Input Volts	Lamp Starting Method	Ballast Family	Catalog Number	Input Power ANSI (Watts)	Ballast Factor	Max. THD %	Line Current (Amps)	Min. Starting Temp. (°F/°C)	Dim.	Wiring Dia.		
F32T8/ES (28W - 48")													
3	120-277	IS	Centium	ICN-3P32-N	77-75	0.90	10	0.65-0.28	60/16	N	65		
				ICN-4P32-N	82-80	1.00		0.68-0.29			*66		
			Optanium	IOP-3P32-LW-N	64-63	0.77	10	0.54-0.23		N	65		
				IOPA-3P32-LW-N									
				IOP-3P32-N	72-71	0.87	10	0.61-0.26					
				IOPA-3P32-N									
				IOP-3P32-HL-N	97-95	1.16	10	0.81-0.35					
				IOPA-3P32-HL-N									
			IOP-4P32-LW-N	69-68	0.85	10	0.58-0.25						
			IOPA-4P32-LW-N										
			PS	Optanium	IOP-4P32-N	79-78	0.97	10		0.66-0.28	60/16	N	*66
					IOPA-4P32-N								
		Optanium		IOP-4P32-HL-SC	106	1.28	10	0.90-0.39	B	178			
				IOP-4P32-HL-90C-SC									
				PS	IOP-3PSP32-LW-SC	63	0.70	10			0.52-0.23	B	178
					IOP-3PSP32-SC	75	0.88	10			0.62-0.27		
		347	IS	Optanium	GOPA-3P32-LW-SC	62	0.77	10	0.18	60/16	B	65	
					GOPA-3P32-SC	70	0.88		0.20			*66	
	GOPA-4P32-LW-SC				70	0.81	0.20						
	PS		GOPA-4P32-SC		79	0.97	0.23		178				
			GOP-3PSP32-SC		73	0.88	0.17						
			GOP-4PSP32-LW-SC		65	0.74	0.19						
	347-480	PS	GOP-4PSP32-SC	74	0.93	0.22	G	178					
			HOP-4PSP32-HL-G	111	1.24	0.32-0.23							
4	120-277	IS	Centium	ICN-4P32-N	100-98	0.89	10	0.84-0.36	60/16	N	66		
			Optanium	IOP-4P32-LW-N	84-82	0.77	10	0.71-0.30					
				IOPA-4P32-LW-N									
		IOP-4P32-N		96-94	0.87	10	0.81-0.35	N					
		IOPA-4P32-N											
		PS	Optanium	IOP-4P32-HL-SC	127-125	1.13	10	1.08-0.46		B	177		
				IOP-4P32-HL-90C-SC									
				IOP-4PSP32-LW-SC	83	0.71	10	0.69-0.30					
		347	IS	Optanium	IOP-4PSP32-SC	97	0.88	10		0.81-0.35	G	177	
	IOP-4PSP32-HL-G				132-130	1.20	10	1.11-0.48					
	GOPA-4P32-LW-SC				84	0.78	10	0.24	60/16	B			66
	GOPA-4P32-SC		96		0.88	0.28							
	GOP-4PSP32-LW-SC		77		0.71	0.23							
	347-480		PS		GOP-4PSP32-SC	91	0.88	0.27	G	177			
		HOP-4PSP32-HL-G		133	1.16	0.39-0.28							

Refer to page 3-53 and 3-54 for dimensions.
 Refer to page 3-55 and 3-56 for wiring diagrams.
 Refer to pages 9-24 to 9-28 for lead lengths and shipping data.

For 32W T8 Lamps

HIGH POWER FACTOR SOUND RATED A



No. of Lamps	Input Volts	Lamp Starting Method	Ballast Family	Catalog Number	Input Power ANSI (Watts)	Ballast Factor	Max. THD %	Line Current (Amps)	Min. Starting Temp. (°F/°C)	Dim.	Wiring Dia.		
F32T8, FBO31T8, F32T8/U6 (32W)													
1	120	IS	AmbiStar [†]	REB-2P32-N	35	1.04	150	0.55	0/-18	N	*64		
				ICN-132-MC	30	0.88	10	0.25-0.11	0/-18	A2	63		
	ICN-1P32-N	31	0.90	10	0.26-0.12	N	*64						
	ICN-2P32-N	36	1.03	15	0.30-0.14								
	120-277	IS	Optanium	IOP-1P32-LW-N	25	0.77	10	0.22-0.10	-20/29	N	63		
				IOPA-1P32-LW-N									
				IOP-1P32-N	28	0.87	10	0.25-0.11		N			
				IOPA-1P32-N									
				IOP-1P32-HL-N	37-36	1.17	10	0.31-0.13		N			
				IOPA-1P32-HL-N									
				IOP-2P32-LW-N	31	0.90	10	0.26-0.11		N	*64		
				IOPA-2P32-LW-N									
				IOP-2P32-N	35	1.05	10	0.30-0.13					
				IOPA-2P32-N									
				IOP-2P32-HL-N	45	1.37	10	0.37-0.17					
				IOPA-2P32-HL-N									
				PS	IOP-1PSP32-LW-N	25	0.72	10		0.20-0.09	0/-18	N	20
					IOP-1PSP32-N	28	0.88	10		0.24-0.10			
	IOP-2PSP32-LW-N	26	0.73		10	0.22-0.10							
	IOP-2PSP32-N	32	0.94		10	0.27-0.12							
	IOP-2PSP32-HL-N	44	1.33		10	0.38-0.17							
								39					
	347	IS	Optanium	GOPA-1P32-LW-SC	26	0.77	10	0.08	-20/29	B	63		
				GOPA-1P32-SC	30	0.88	10	0.09					
GOPA-2P32-LW-SC				31	0.88	10	0.09						
GOPA-2P32-SC				34	1.03	10	1.03						
PS		GOP-2PSP32-LW-SC		32	0.73	10	0.08	0/-18	L	77			
		GOP-2PSP32-SC		34	1.03	10	0.09						
		347-480		PS	HOP-2PSP32-HL-L	45	1.30				10	0.14-0.10	

[†] The above AmbiStar ballasts are normal power factor and labeled 'For Residential Use Only.'

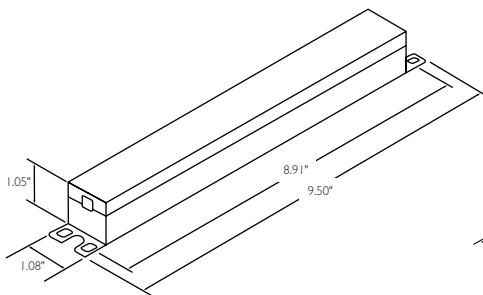

Fig. A2

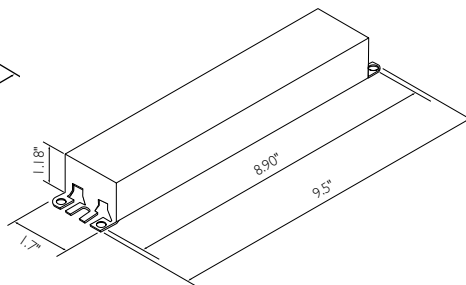

Fig. B

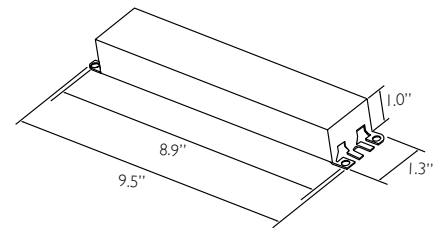

Fig. N

Refer to page 3-54 for additional dimensions.
 Refer to page 3-55 and 3-56 for wiring diagrams.
 Refer to pages 9-24 to 9-28 for lead lengths and shipping data.

For 32W T8 Lamps

HIGH POWER FACTOR SOUND RATED A



No. of Lamps	Input Volts	Lamp Starting Method	Ballast Family	Catalog Number	Input Power ANSI (Watts)	Ballast Factor	Max. THD %	Line Current (Amps)	Min. Starting Temp. (°F/°C)	Dim.	Wiring Dia.	
F32T8, FBO31T8, F32T8/U6 (32W)												
2	120	IS	AmbiStar [†]	REB-2P32-N	57	0.85	134	0.85	0/-18	N	64	
		RS	PowrKut	RK-2S32-TP	66	0.86	15	0.60	50/10	A	21	
	277	RS	PowrKut	VK-2S32-TP	66	0.85	15	0.26		0/-18	A2	64
	120-277	IS	Centium	ICN-2M32-MC	59	0.88	10	0.50-0.21	-20/-29		N	*65
				ICN-2P32-N	59	0.88	10	0.49-0.22				
				ICN-3P32-N	65	1.01	10	0.54-0.24				
		Optanium	IS	IOP-2P32-LW-N	48	0.77	10	0.41-0.17	-20/-29	N	64	
				IOPA-2P32-LW-N								
			IOP-2P32-N	55-54	0.87	10	0.47-0.20					
			IOPA-2P32-N									
			IOP-2P32-HL-N	74-72	1.18	10	0.62-0.26					
			IOPA-2P32-HL-N									
			IOP-3P32-LW-N	55-54	0.85	10	0.46-0.20					
			IOPA-3P32-LW-N									
			IOP-3P32-N	63-62	1.00	10	0.53-0.23					
			IOPA-3P32-N									
			IOP-3P32-HL-N	80-79	1.38	10	0.67-0.29					
	IOP-3P32-HL-90C-N											
	IOPA-3P32-HL-N											
	PS	IOP-2PSP32-LW-N	46-45	0.71	10	0.40-0.17	0/-18	N	21			
		IOP-2PSP32-N	58	0.85	10	0.48-0.21						
		IOP-2PSP32-HL-N	76-73	1.19	10	0.63-0.27						
		IOP-3PSP32-LW-SC	51	0.76	10	0.42-0.19						
		IOP-3PSP32-SC	64-63	1.05	10	0.53-0.23						
IOP-3PSP32-HL-SC		86	1.32	10	0.72-0.31							
347	IS	Optanium	GOPA-2P32-LW-SC	48	0.78	10	0.14	-20/-29	B	64		
			GOPA-2P32-SC	54	0.88	10	0.16					
			GOPA-3P32-LW-SC	55	0.86	10	0.16					
			GOPA-3P32-SC	63	1.00	10	0.18					
	PS	GOP-2PSP32-LW-SC	51	0.76	10	0.15	0/-18	L	21			
		GOP-2PSP32-SC	57	0.88	10	0.17						
		HOP-2PSP32-HL-L	79	1.20	10	0.23-0.17						
		347-480										

[†] The above AmbiStar ballasts are normal power factor and labeled 'For Residential Use Only.'

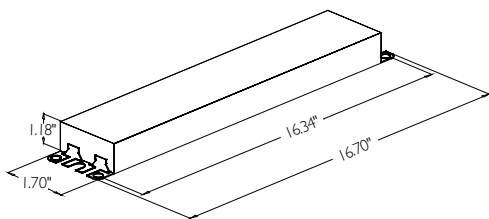

Fig. G

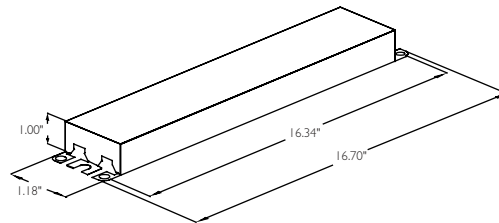

Fig. L

Refer to page 3-53 for additional dimensions.
 Refer to page 3-55 and 3-56 for wiring diagrams.
 Refer to pages 9-24 to 9-28 for lead lengths and shipping data.

For 32W T8 Lamps

HIGH POWER FACTOR SOUND RATED A



No. of Lamps	Input Volts	Lamp Starting Method	Ballast Family	Catalog Number	Input Power ANSI (Watts)	Ballast Factor	Max. THD %	Line Current (Amps)	Min. Starting Temp. (°F/°C)	Dim.	Wiring Dia.						
F32T8, FBO31T8, F32T8/U6 (32W)																	
3	120	IS	AmbiStar [†]	REB-4P32-SC	80	0.84	125	1.36	0/-18	B	*66						
			Centium	ICN-3P32-N	87-85	0.88	10	0.71-0.31		N	65						
				ICN-4P32-N	93	1.00	10	0.78-0.33		N	*66						
	120-277	IS	Optanium	IOP-3P32-LW-N	73-71	0.77	10	0.62-0.27	-20/-29	N	65						
				IOPA-3P32-LW-N													
				IOP-3P32-N	82-80	0.87	10	0.70-0.30									
				IOPA-3P32-N													
				IOP-3P32-HL-N													
				IOP-3P32-HL-90C-N	110-108	1.18	10	0.92-0.40									
				IOPA-3P32-HL-N													
				IOP-4P32-LW-N	80-79	0.84	10	0.67-0.29									
				IOPA-4P32-LW-N													
				IOP-4P32-N	90-88	0.97	10	0.75-0.32									
				IOPA-4P32-N													
				IOP-4P32-HL-SC	122-120	1.29	10	1.02-0.44									
				IOP-4P32-HL-90C-SC													
				PS	PS	Optanium	IOP-3PSP32-LW-SC	68-67				0.69	10	0.56-0.25	0/-18	B	178
							IOP-3PSP32-SC	85				0.88	10	0.71-0.37			
	IOP-3PSP32-HL-SC	113-110	1.18				10	0.94-0.40									
	IOP-4PSP32-LW-SC	77	0.71				10	0.65-0.28									
	IOP-4PSP32-SC	90	0.88				10	0.76-0.33									
	IOP-4PSP32-HL-G	126-122	1.29				10	1.05-0.45									
	347	IS	Optanium	GOPA-3P32-LW-SC	74	0.77	10	0.21	-20/-29	B	65						
				GOPA-3P32-SC	84	0.88	10	0.24									
				GOPA-4P32-LW-SC	77	0.81	10	0.23									
				GOPA-4P32-SC	89	0.96	10	0.26									
				GOP-3PSP32-SC	84	0.87	10	0.25									
		PS		PS	GOP-4PSP32-LW-SC	80	0.74	10	0.23		0/-18	178					
					GOP-4PSP32-SC	93	0.93	10	0.23								
					347-480	PS	Optanium	HOP-4PSP32-HL-G	124				1.17	10	0.36-0.26	G	

[†] The above AmbiStar ballasts are normal power factor and labeled 'For Residential Use Only.'

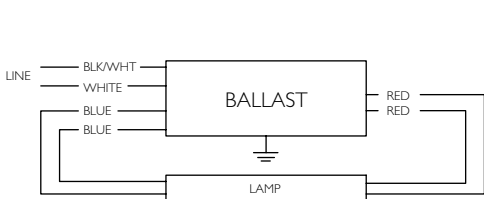

Diag. 20

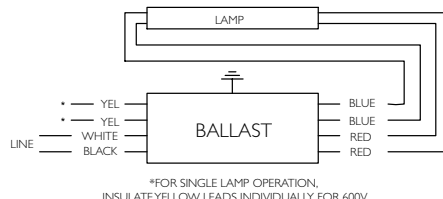

Diag. 39

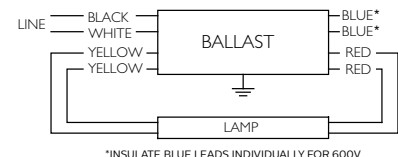

Diag. 77

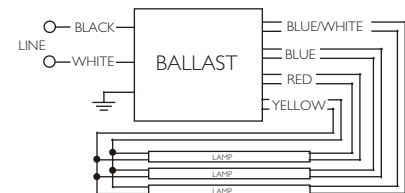

Diag. 178

Refer to page 3-53 and 3-54 for dimensions.
Refer to page 3-56 for additional wiring diagrams.
Refer to pages 9-24 to 9-28 for lead lengths and shipping data.

For 32W T8 Lamps

HIGH POWER FACTOR SOUND RATED A



No. of Lamps	Input Volts	Lamp Starting Method	Ballast Family	Catalog Number	Input Power ANSI (Watts)	Ballast Factor	Max. THD %	Line Current (Amps)	Min. Starting Temp. (°F/°C)	Dim.	Wiring Dia.
F32T8, FBO31T8, F32T8/U6 (32W)											
4	120	IS	AmbiStar [‡]	REB-4P32-SC	103	0.81	125	1.57	0/-18	B	66
			Centium	ICN-4P32-N	112	0.88	10	0.94-0.41		N	
	120-277	IS	Optanium	IOP-4P32-LW-N	96-94	0.77	10	0.81-0.35	-20/-29	N	66
				IOPA-4P32-LW-N							
				IOP-4P32-N	109-106	0.87	10	0.92-0.39		N	
				IOPA-4P32-N							
				IOP-4P32-HL-SC	148-144	1.18	10	1.26-0.53		B	
				IOP-4P32-HL-90C-SC							
	PS	Optanium	IOP-4PSP32-LW-SC	94	0.71	10	0.78-0.33	0/-18	B	177	
			IOP-4PSP32-SC	110	0.88	10	0.93-0.40		G		
			IOP-4PSP32-HL-G	153-149	1.18	10	1.28-0.55				
	347	IS	Optanium	GOPA-4P32-LW-SC	92	0.78	10	0.27	-20/-29	B	66
				GOPA-4P32-SC	107	0.88	10	0.31			
				GOP-4PSP32-LW-SC	92	0.70	10	0.27			
PS		Optanium		GOP-4PSP32-SC	114	0.88	10	0.33	0/-18		177
				HOP-4PSP32-HL-G	152	1.17	10	0.44-0.32			

[‡] The above AmbiStar ballasts are normal power factor and labeled 'For Residential Use Only.'

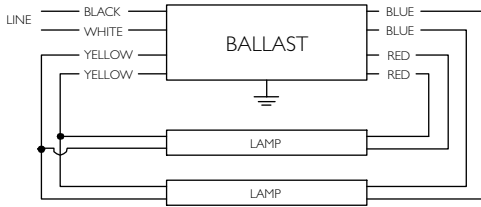

Diag. 21

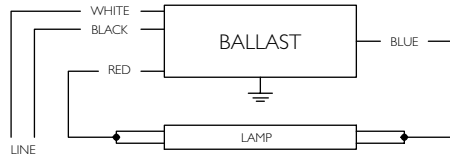

Diag. 63

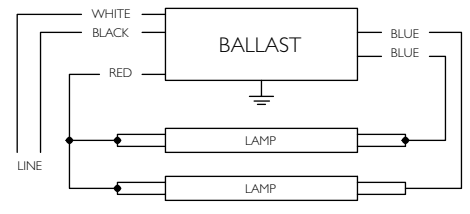

*FOR SINGLE LAMP OPERATION, INSULATE UNUSED BLUE LEAD FOR 600V

Diag. 64

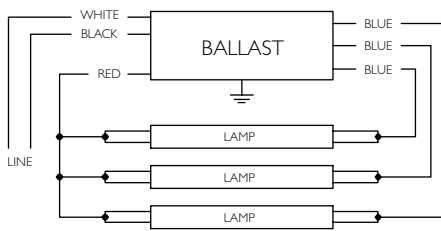

*FOR TWO LAMP OPERATION, INSULATE UNUSED BLUE LEADS INDIVIDUALLY FOR 600V

Diag. 65

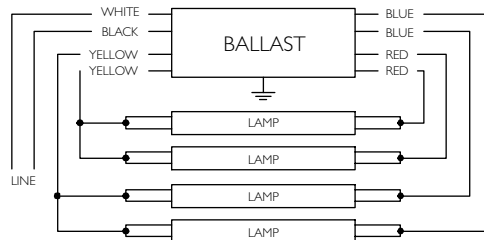

*FOR THREE LAMP OPERATION, INSULATE UNUSED BLUE LEADS INDIVIDUALLY FOR 600V

Diag. 66

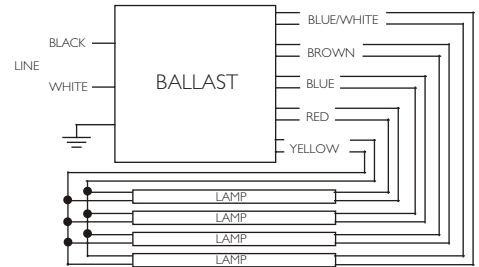

Diag. 177

Refer to page 3-53 and 3-54 for dimensions.
 Refer to page 3-55 for additional wiring diagrams.
 Refer to pages 9-24 to 9-28 for lead lengths and shipping data.

For 40W T8 Lamps

HIGH POWER FACTOR SOUND RATED A



No. of Lamps	Input Volts	Lamp Starting Method	Ballast Family	Catalog Number	Input Power ANSI (Watts)	Ballast Factor	Max. THD %	Line Current (Amps)	Min. Starting Temp. (°F/°C)	Dim.	Wiring Dia.
F40T8 (40W)											
1	120-277	IS	AmbiStar	REB-2P32-N	42	1.05	140	0.62	32/0	N	*64
			Optanium	IOP-2P32-LW-N	35	0.87	10	0.29-0.13			
				IOPA-2P32-LW-N							
				IOP-2P32-N	41	1.01	10	0.35-0.15			
				IOPA-2P32-N							
				IOP-2P32-HL-N	55-54	1.35	10	0.46-0.20			
	IOPA-2P32-HL-N										
	347	IS	Optanium	GOPA-2P32-LW-SC	37	0.86	10	0.11		B	
GOPA-2P32-SC				42	1.02	0.12					
2	120-277	IS	Centium	ICN-3P32-N	77	1.00	10	0.65-0.28	32/0	N	*65
			Optanium	IOP-3P32-LW-N	67-66	0.85	10	0.58-0.25			
				IOPA-3P32-LW-N							
				IOP-3P32-N	74-72	1.01	10	0.64-0.27			
				IOPA-3P32-N							
				IOP-3P32-HL-N	102-100	1.30	10	0.85-0.37			
				IOP-3P32-HL-90C-N							
				IOPA-3P32-HL-N							
	347	IS		Optanium	GOPA-3P32-LW-SC	65	0.85	10		0.19	
			GOPA-3P32-SC		75	1.00	0.22				

Refer to page 3-58 for wiring diagrams and dimensions.
Refer to pages 9-24 to 9-28 for lead lengths and shipping data.

For 40W T8 Lamps

HIGH POWER FACTOR SOUND RATED A



No. of Lamps	Input Volts	Lamp Starting Method	Ballast Family	Catalog Number	Input Power ANSI (Watts)	Ballast Factor	Max. THD %	Line Current (Amps)	Min. Starting Temp. (°F/°C)	Dim.	Wiring Dia.
F40T8 (40W)											
3	120-277	IS	Centium	ICN-4P32-N	112	0.97	10	0.94-0.40	32/0	N	*66
			Optanium	IOP-4P32-LW-N	98-96	0.84	10	0.82-0.35			
				IOPA-4P32-LW-N							
				IOP-4P32-N	110-107	0.93	10	0.92-0.38			
				IOPA-4P32-N							
			IOP-4P32-HL-SC	150-147	1.25	10	1.27-0.54				
	IOP-4P32-HL-90C-SC										
	347	IS	Optanium	GOPA-4P32-LW-SC	97	0.84	10	0.28	B		
				GOPA-4P32-SC	113	0.93		0.28			

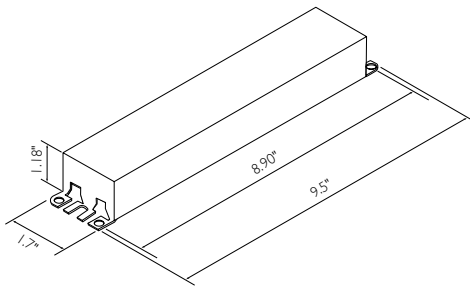

Fig. B

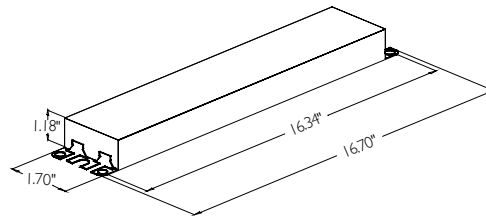

Fig. G

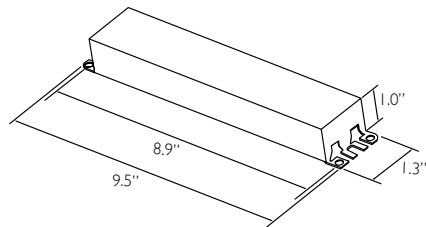
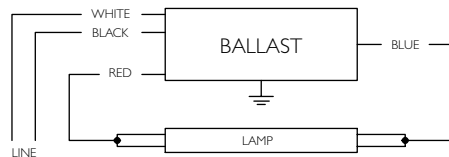
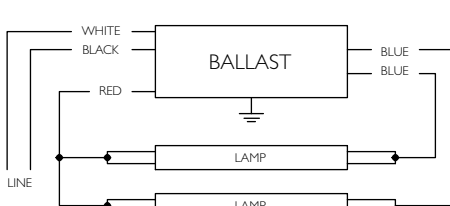

Fig. N



Diag. 63



Diag. 64

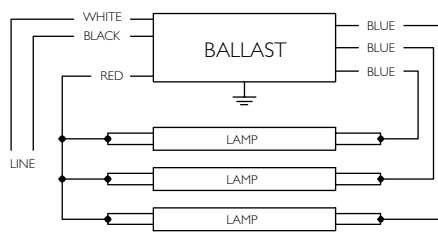

Diag. 65

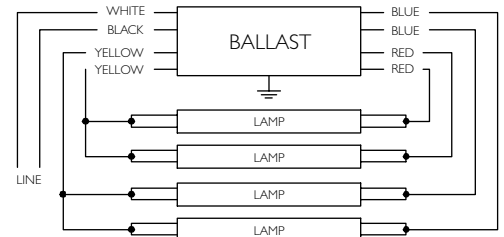

Diag. 66

Refer to pages 9-24 to 9-28 for lead lengths and shipping data.

For 59W T8 Slimline Lamps

HIGH POWER FACTOR SOUND RATED A



No. of Lamps	Input Volts	Lamp Starting Method	Ballast Family	Catalog Number	Input Power ANSI (Watts)	Ballast Factor	Max. THD %	Line Current (Amps)	Min. Starting Temp. (°F/°C)	Dim.	Wiring Dia.
F96T8 (59W)											
1	120-277	IS	Optanium	IOP-2P59-N	72	1.05	10	0.60-0.27	32/0	N	*64A
2	120-277	IS	Optanium	IOP-2P59-N	113-111	0.87	10	0.95-0.41	32/0	N	64A

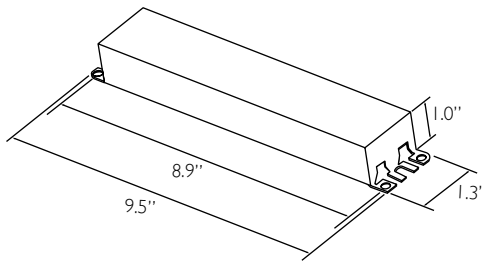
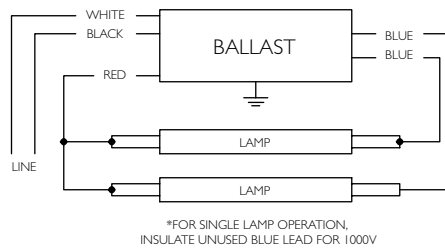

Fig. N



*FOR SINGLE LAMP OPERATION,
INSULATE UNUSED BLUE LEAD FOR 1000V

Diag. 64A

Refer to pages 9-24 to 9-28 for lead lengths and shipping data.

For 44-86W T8HO Lamps

HIGH POWER FACTOR SOUND RATED A



No. of Lamps	Input Volts	Lamp Starting Method	Ballast Family	Catalog Number	Input Power ANSI (Watts)	Ballast Factor	Max. THD %	Line Current (Amps)	Min. Starting Temp. (°F/°C)	Dim.	Wiring Dia.
F48T8/HO (44W)											
1	120-277	PS	Centium	ICN-2S86-SC	48	0.99	30	0.40-0.19	-20/-29	B	77
2	120-277			ICN-2S86-SC	93-92	0.98	15	0.77-0.35			21
F72T8/HO (65W)											
1	120-277	PS	Centium	ICN-2S86-SC	71	1.02	20	0.59-0.27	-20/-29	B	77
2	120-277			ICN-2S86-SC	138-137	1.00	10	1.15-0.51			21
F96T8/HO (86W)											
1	120-277	PS	Centium	ICN-2S86-SC	92	1.02	15	0.77-0.34	-20/-29	B	77
2	120-277			ICN-2S86-SC	182-178	1.00	10	1.52-0.65			21

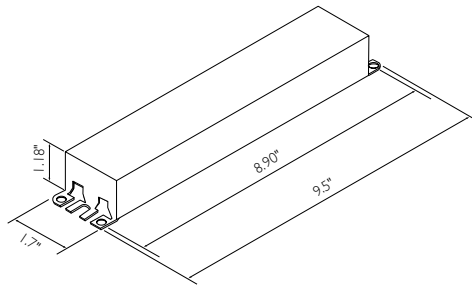
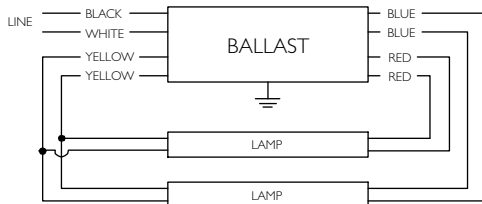
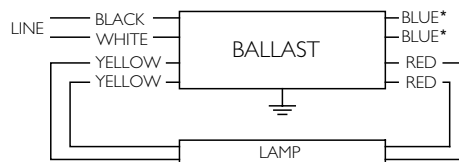

Fig B



Diag. 21



*INSULATE BLUE LEADS INDIVIDUALLY FOR 600V

Diag. 77

Refer to pages 9-24 to 9-28 for lead lengths and shipping data.

For 30-40W T12 Lamps

HIGH POWER FACTOR SOUND RATED A



No. of Lamps	Input Volts	Lamp Starting Method	Ballast Family	Catalog Number	Input Power ANSI (Watts)	Ballast Factor	Max. THD %	Line Current (Amps)	Min. Starting Temp. (°F/°C)	Dim.	Wiring Dia.
F30T12 (30W - 36")											
1	120	RS	AmbiStar	RELB-2S40-N	26	0.89	20	0.22	50/10	N	39
1	120-277	RS	Centium	ICN-2S40-N	26	0.89	10	0.22-0.10			
2	120	RS	AmbiStar	RELB-2S40-N	51	0.92	20	0.42	50/10	N	21
2	120-277	RS	Centium	ICN-2S40-N	51	0.92	10	0.42-0.18			
F34T12, F34T12/U (34W)											
1	120	RS	AmbiStar	RELB-2S40-N	28	0.90	20	0.24	50/10	N	39
1	120-277		Centium	ICN-2S40-N	28	0.90	10	0.24-0.11			
2	120	RS	AmbiStar	RELB-2S40-N	54	0.91	20	0.45	50/10	N	21
2	120-277		Centium	ICN-2S40-N	54	0.91	10	0.45-0.20			
F40T12, F40T12/U (40W)											
1	120	RS	AmbiStar	RELB-2S40-N	35	0.91	20	0.29	50/10	N	39
1	120-277		Centium	ICN-2S40-N	35	0.91	10	0.29-0.13			
2	120	RS	AmbiStar	RELB-2S40-N	66	0.91	20	0.56	50/10	N	21
2	120-277		Centium	ICN-2S40-N	67	0.91	10	0.56-0.24			

* Normal Power Factor

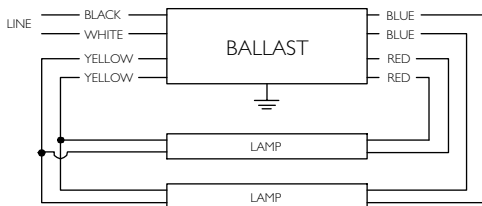

Diag. 21

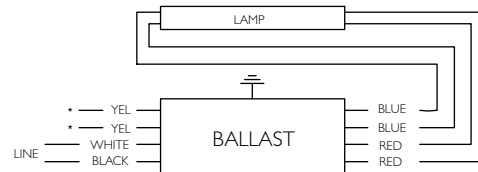

*FOR SINGLE LAMP OPERATION, INSULATE YELLOW LEADS INDIVIDUALLY FOR 600V

Diag. 39

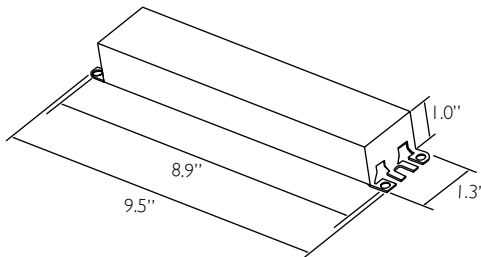

Fig. N

Refer to pages 9-24 to 9-28 for lead lengths and shipping data.

For 55-75W T12 Slimline Lamps

HIGH POWER FACTOR SOUND RATED A



No. of Lamps	Input Volts	Lamp Starting Method	Ballast Family	Catalog Number	Input Power ANSI (Watts)	Ballast Factor	Max. THD %	Line Current (Amps)	Min. Starting Temp. (°F/°C)	Dim.	Wiring Dia.
F72T12 (55W)											
1	120-277	IS	Centium	ICN-2P60-N	68-67	1.05	10	0.70-0.31	0/-18	N	*64A
2	120-277				108-107	0.92	10	0.91-0.40			64A
F96T12/ES (60W)											
1	120-277	IS	Centium	ICN-2P60-N	70-68	1.04	10	0.53-0.24	60/16	N	*64A
2	120-277				108-106	0.87	10	0.90-0.34			64A
F96T12 (75W)											
1	120-277	IS	Centium	ICN-2P60-N	84-82	1.04	10	0.55-0.25	0/-18	N	*64A
2	120-277				135-132	0.88	10	1.13-0.48			64A

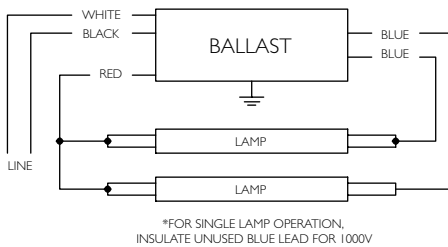

Diag. 64A

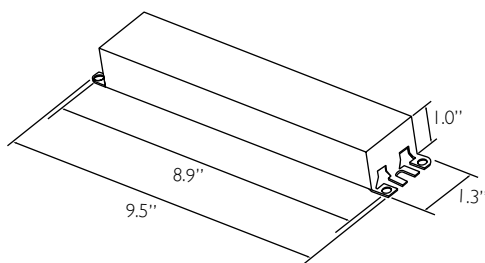

Fig. N

Refer to pages 9-24 to 9-28 for lead lengths and shipping data.

For 95 - 110W T12/HO Lamps

HIGH POWER FACTOR SOUND RATED A



No. of Lamps	Input Volts	Lamp Starting Method	Ballast Family	Catalog Number	Input Power ANSI (Watts)	Ballast Factor	Max. THD %	Line Current (Amps)	Min. Starting Temp. (°F/°C)	Dim.	Wiring Dia.
F48T12/HO (48W)											
2	120-277	RS	Centium	ICN-2S110-SC	93-92	0.90	10	0.82-0.35	-20/-29	B	21
F60T12/HO (60W)											
2	120-277	RS	Centium	ICN-2S110-SC	116-114	1.00	10	0.98-0.42	-20/-29	B	21
F72T12/HO (72W)											
2	120-277	RS	Centium	ICN-2S110-SC	140-138	0.90	10	1.19-0.51	-20/-29	B	21
F96T12/HO (95W)											
1	120-277	RS	Centium	ICN-2S110-SC	78-77	0.91	10	0.68 - 0.29	60/16	B	39A
2	120-277				154-151	0.89	10	1.30 - 0.56			21
F96T12/HO (110W)											
1	120-277	RS	Centium	ICN-2S110-SC	100-92	0.91	10	0.88 - 0.35	-20/-29	B	39A
2	120-277				194-190	0.89	10	1.64 - 0.70			21

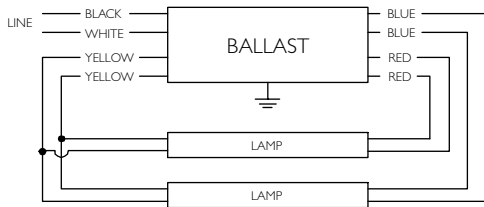

Diag. 21

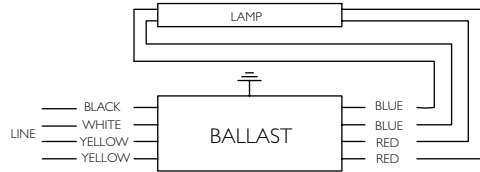

*FOR SINGLE LAMP OPERATION, INSULATE YELLOW LEADS INDIVIDUALLY FOR 1000V

Diag. 39A

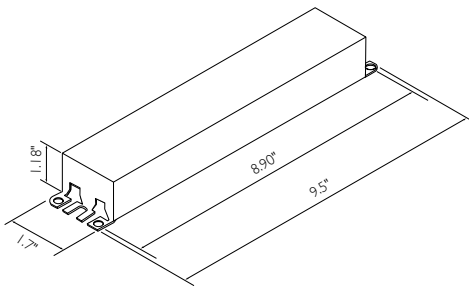

Fig. B

Refer to pages 9-24 to 9-28 for lead lengths and shipping data.

For T8/HO and T12/HO Lamps

HIGH POWER FACTOR SOUND RATED A



Number of Lamps	Lamp Footage		Min. Starting Temp. (°F)	Input Volts	Catalog Number	Max. Line Current (Amps) @ 120V	Max. Input Power (Watts) @ 120V	Max. Line Current (Amps) @ 277V	Max. Input Power (Watts) @ 277V	Open Circuit Volts	Dim.	Wiring Diag.	Weight (Kg/LB.)
	Min	Max											
1, 2	2 ^a	16 ^a	-20°F	120 to 277	ISB-0216-12-E	1.14	136	0.49	133	660	BL-1	301, 302	0.66/1.45
1, 2, 3, 4	4 ^b	32 ^b			ISB-0432-14-E	2.26	273	0.97	270	800	BL-2	307, 308, 303, 304	2.00/4.40
1, 2, 3, 4	10 ^c	40 ^c			ISB-1040-14-E	2.88	348	1.24	346	950	BL-2	307, 308, 303, 304	2.20/4.85
4, 5, 6	8 ^d	48 ^d			ISB-0848-46-E	3.40	415	1.46	410	800	BL-2	309, 305, 306	2.20/4.85

Ballast Selection Guide for SignPRO Electronic Sign Ballasts

Number of Lamps per Ballast	Total Lamp Feet																				Wiring Diagram			
	2	4	6	8	10	12	14	16	18	20	22	24	26	28	30	32	34	36	38	40		42	44	46
1, 2	ISB-0216-12-E																				301, 302			
1, 2, 3, 4	ISB-0432-14-E																				307, 308, 303, 304			
1, 2, 3, 4	ISB-1040-14-E																				307, 308, 303, 304			
4, 5, 6	ISB-0848-46-E																				309, 305, 306			

- a For use with any 1 to 2 lamp T12HO lamps up to 8 feet long, 2 feet to 16 feet total length. For use with any 1 to 2 lamp T8HO lamps up to 6 feet long, 4 feet to 12 feet total length. For use with T12HO / T8HO lamps or any combination of lamps in circuit as long as total length per circuit does not exceed 7 feet for T12HO and 5 feet for T8HO.
- b For use with any 1 to 4 lamp T12HO lamps up to 8 feet long, 4 feet to 32 feet total length. For use with any 1 to 4 lamp T8HO lamps up to 6 feet long, 4 feet to 24 feet total length. For use with T12HO / T8HO lamps or any combination of lamps in circuit as long as total length per circuit does not exceed 7 feet for T12HO and 5 feet for T8HO.
- c For use with any 1 to 4 lamp T12HO lamps up to 10 feet long, 10 feet to 40 feet total length. For use with any 1 to 4 lamp T8HO lamps up to 8 feet long, 8 feet to 32 feet total length. For use with T12HO / T8HO lamps or any combination of lamps in circuit as long as total length per circuit does not exceed 9 feet for T12HO and 7 feet for T8HO.
- d For use with any 4 to 6 lamp T12HO lamps up to 8 feet long, 8 feet to 48 feet total length. For use with any 4 to 6 lamp T8HO lamps up to 6 feet long, 16 feet to 36 feet total length. For use with T12HO / T8HO lamps or any combination of lamps in circuit as long as total length per circuit does not exceed 7 feet for T12HO and 5 feet for T8HO.

Refer to pages 9-24 to 9-28 for lead lengths and shipping data.

T8/HO and T12/HO wiring diagrams

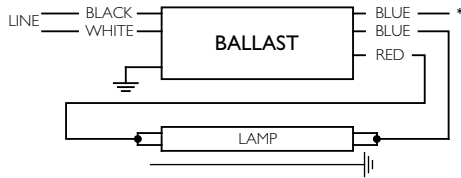

*INSULATE UNUSED LEAD FOR 1000V
ALL LEADS TO GROUND < 600V

Diagram 301

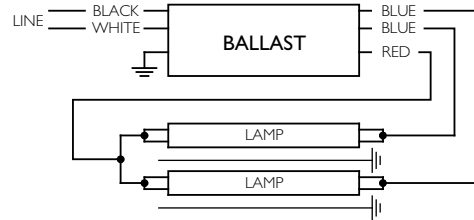

ALL LEADS TO GROUND < 600V

Diagram 302

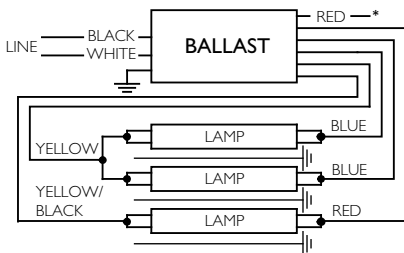

*INSULATE UNUSED LEAD FOR 1000V
ALL LEADS TO GROUND < 600V

Diagram 303

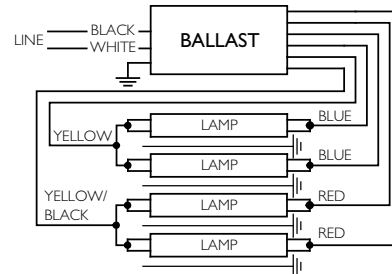

ALL LEADS TO GROUND < 600V

Diagram 304

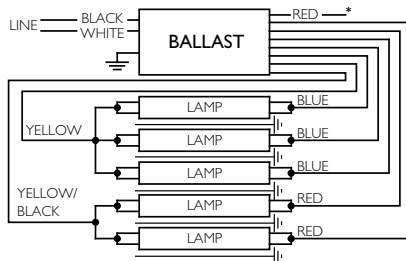

*INSULATE UNUSED LEAD FOR 1000V
ALL LEADS TO GROUND < 600V

Diagram 305

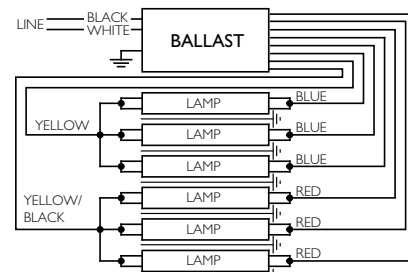

ALL LEADS TO GROUND < 600V

Diagram 306

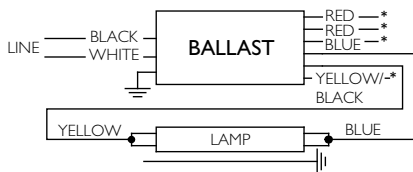

*INSULATE UNUSED LEAD FOR 1000V
ALL LEADS TO GROUND < 600V

Diagram 307

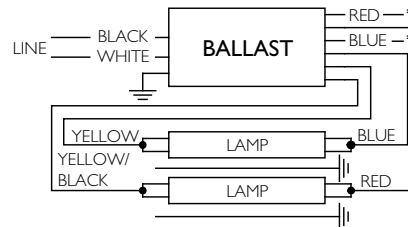

*INSULATE UNUSED LEAD FOR 1000V
ALL LEADS TO GROUND < 600V

Diagram 308

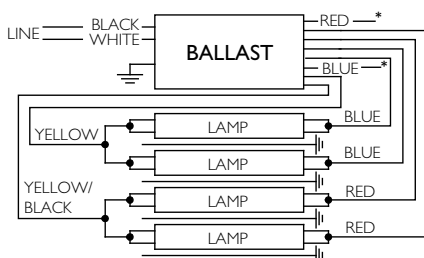

*INSULATE UNUSED LEAD FOR 1000V
ALL LEADS TO GROUND < 600V

Diagram 309

Note: When retrofitting with an instant start system to replace a rapid start system, some modifications to the socket wiring are necessary for optimal performance. This requires the two lamp pins to be shunted as close to the socket as possible. Do this by either installing shunted sockets or installing a jumper wire to tie the two lamp pins together in each socket. Failure to shunt the pins together will cause the lamps to fail prematurely.

T8/HO and T12/HO dimensions

Designation	Dimension (inches)				
	Length (L)	Width (W)	Height (H)	Mounting (M1)	Mounting (M2)
BL-1	9.45	1.69	1.13	9.00	1.22
BL-2	14.31	3.16	1.39	13.75	2.00

Lead Lengths	
Black, White	24"
Red, Blue	120"
Yellow	120"
Yellow/Black	120"

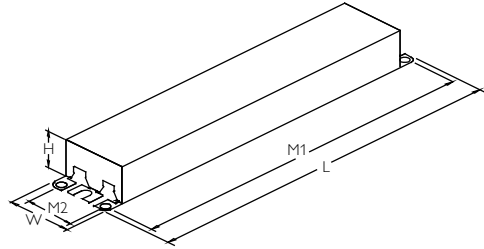

For 18 – 145W UV Disinfection Lamps

HIGH POWER FACTOR SOUND RATED A



No. of Lamps	Input Volts	Lamp Starting Method	Ballast Family	Catalog Number	Input Power ANSI (Watts)	Lamp Current (mAmps)	Max. THD %	Line Current (Amps)	Min. Starting Temp. (°F/°C)	Dim.	Wiring Dia.
PL-L18W/TUV (18W)											
1	120 - 277	PS	PureVOLT	IUV-2S18-H1-LD	30	290	10	0.26 - 0.11	0/-18	Size 1	160
2	120 - 277	PS	PureVOLT	IUV-2S18-H1-LD	55	280	10	0.47 - 0.20	0/-18	Size 1	159
PL-L36W/TUV (36W)											
1	120 - 277	PS	PureVOLT	IUV-2S36-M2-LD	51	330	10	0.44 - 0.19	0/-18	Size 2	160
2	120 - 277	PS	PureVOLT	IUV-2S36-M2-LD	90	285	10	0.78 - 0.33	0/-18	Size 2	159
PL-L35WHO/TUV (35W)											
1	120 - 277	PS	PureVOLT	IUV-2S60-M4-LD	42	900	15	0.36-0.18	0/-18	Size 4	160
2	120 - 277	PS	PureVOLT	IUV-2S60-M4-LD	81	870	10	0.68-0.30	0/-18	Size 4	159
PL-L60WHO/TUV (60W)											
1	120 - 277	PS	PureVOLT	IUV-2S60-M4-LD	77	870	10	0.65-0.29	0/-18	Size 4	160
2	120 - 277	PS	PureVOLT	IUV-2S60-M4-LD	133	800	10	1.10-0.48	0/-18	Size 4	159
PL-L95WHO/TUV (95W)											
1	120 - 277	PS	PureVOLT	IUV-2S60-M4-LD	96	850	10	0.75-0.35	0/-18	Size 4	160
TUV 36T5/HO (75W)											
1	120 - 277	PS	PureVOLT	IUV-2S60-M4-LD	74	850	10	0.62-0.28	0/-18	Size 4	160
2	120 - 277	PS	PureVOLT	IUV-2S60-M4-LD	127	790	10	1.05-0.46	0/-18	Size 4	159
TUV 64T5/HO (145W)											
1	120 - 277	PS	PureVOLT	IUV-2S60-M4-LD	120	800	10	1.10-0.44	0/-18	Size 4	160

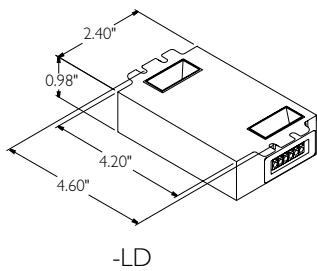

-LD
Size 1

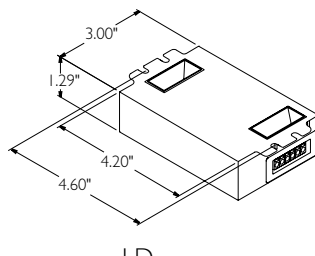

-LD
Size 2

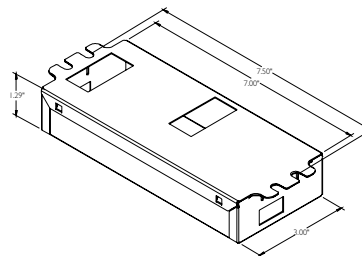

Size 4

Refer to pages 3-68 for wiring diagrams.

For 58 - 70W Refrigeration Lamps

HIGH POWER FACTOR SOUND RATED A



No. of Lamps	Input Volts	Lamp Starting Method	Ballast Family	Catalog Number	Input Power ANSI (Watts)	Ballast Factor	Max. THD %	Line Current (Amps)	Min. Starting Temp. (°F/°C)	Dim.	Wiring Dia.
F58T8 (58W)											
1	120 - 277	PS	Centium	ICN-2S54-N	60	1.08	15	0.51 - 0.23	-20/-29	N	73
				ICN-2S54-T	59	1.04	10	0.49 - 0.22		T	
				ICN-2S54-90C-N	60	1.08	15	0.51 - 0.23		N	
				ICN-2S54-90C-T	59	1.04	10	0.49 - 0.22		T	
2	120 - 277	PS	Centium	ICN-2S54-N	112-108	1.00	10	0.94 - 0.40	-20/-29	N	74
				ICN-2S54-T	110-109	1.00	10	0.92 - 0.39		T	
				ICN-2S54-90C-N	112-108	1.00	10	0.94 - 0.40		N	
				ICN-2S54-90C-T	110-109	1.00	10	0.92 - 0.39		T	
3	120 - 277	PS	Centium	ICN-4S54-90C-2LS-G	171	1.00	10	1.43 - 0.62	-20/-18	G	75A
4	120 - 277	PS	Centium	ICN-4S54-90C-2LS-G	225	1.00	10	1.88 - 0.81	-20/-18	G	75
F70T8 (70W)											
1	120 - 277	PS	Centium	ICN-1S80-T	72-71	1.12	10	0.60-0.26	0/-18	T	73

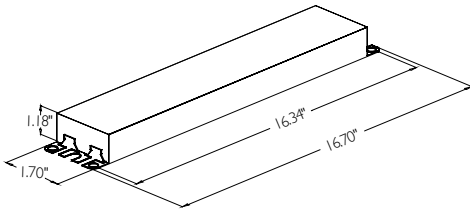

Fig. G

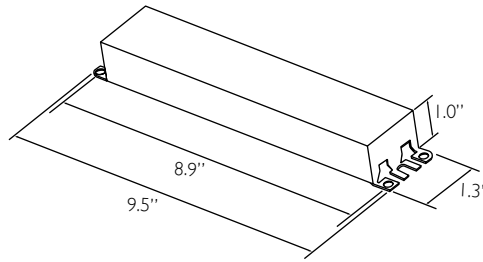

Fig. N

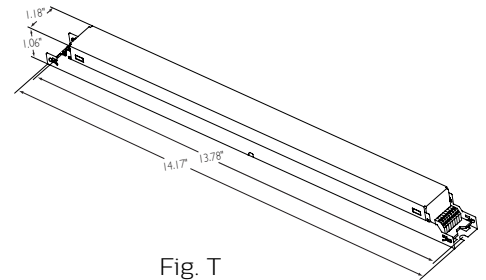
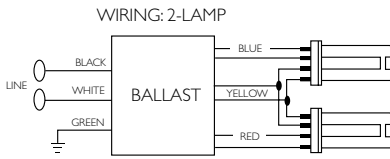
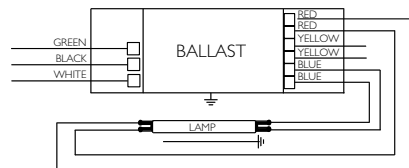

Fig. T
Includes connectors with no leads



Diag. 159

Green terminal must be grounded



Diag. 73

For 1 lamp operation, do not use yellow leads

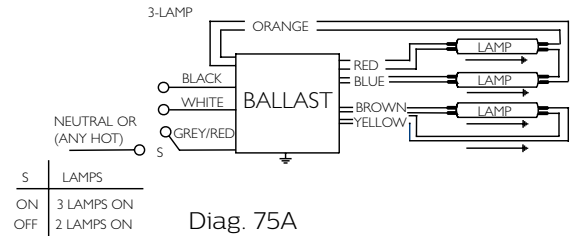

Diag. 75A

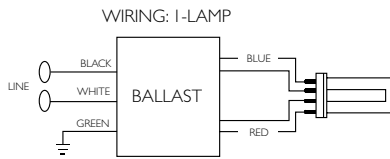

Diag. 160

Green terminal must be grounded

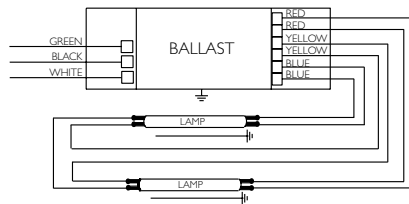

Diag. 74

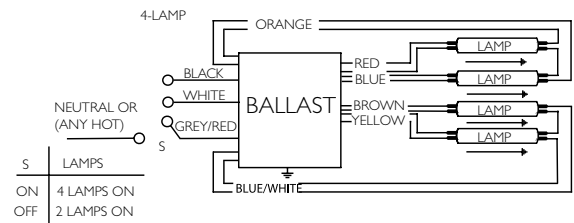

Diag. 75

Footnotes from pages 3-7 and 3-10:

- 1 Based on input watts of IOP-2PSP32N (58W) and IOP-2P32-N (54W)
- 2 Based on engineering data testing and probability analysis. The criteria are 50,000 hours of operation with 90% surviving when operated at the ballast maximum Tc point, typically 70°C.



Electronic Fluorescent Controllable Ballasts

Optanium Step-Dim	4-1
Mark 10 <i>Powerline</i>	4-4
Mark 7 0-10V	4-10
ROVR	4-17
Compatible Controls	4-23

Corporate Offices
(800) 322-2086

Customer Support/Technical Service
(800) 372-3331 • (+) 1 847 390-5000 (International)

Visit our web site at www.philips.com/oemna.

Note: Refer to page 9-17 to 9-20 for Ballast Specifications.

Fluorescent Ballasts - Electronic - Optanium Step-Dim

High efficiency electronic ballasts with step-dim capability for T5, T5HO and T8 fluorescent lamps.

Philips Advance Optanium ballasts with step-dim capability for T5 and T8 fluorescent lamps represent an affordable, energy-efficient and versatile lighting solution designed to help meet energy codes such as California's Title 24 and ASHRAE 90.1-2010 that require end users to reduce lighting power consumption by 50%.

Operating from any line voltage switching device, the ballast's programmed start circuitry provides extended lamp life in frequent switching applications like those associated with the use of occupancy sensors or motion detectors making this product the sustainable choice for many commercial applications. The ballast additionally features IntelliVolt multiple voltage technology as well as safety features, including auto restart, ballast shutdown mode, Type CC protection and T5 and T5HO lamp End-of-Life (EOL) protection circuitry, which safely removes power from the lamp upon failure to minimize maintenance concerns. Offering the flexibility of step-dimming with the high-efficiency of Optanium electronic ballast technology, our ballasts represent an optimal lighting solution for a wide variety of professional applications.

Reduce input power by 50% to help meet energy codes

- 50% control step

Dim all the lamps together providing equal burn hours on all lamps reducing uneven lifetimes as experienced with on-off switching systems

- Adjustable light levels — 100% power, 50% power, and off

Ensure ease of use and system compatibility across a broad range of applications

- Operation from any line voltage switching device (such as standard toggle switches and occupancy sensors)



For 14 - 35W T5* or 54W T5/HO Lamps

HIGH POWER FACTOR SOUND RATED A

Optanium Step-Dim Ballasts



No. of Lamps	Input Volts	Lamp Starting Method	Ballast Family	Catalog Number	Max/Min		Full Light Output		Min. Starting Temp. (°F/°C)	Dim.	Wiring Dia.
					Input Power ANSI (Watts)	Ballast Factor	THD %	Line Current (Amps)			
F14T5 (14W)											
2	120-277	PS	Optanium	IOP-2S28-115-SC-SD	38/20	1.15/0.48	15	0.32	0/-18	B	173
F21T5 (21W)											
2	120-277	PS	Optanium	IOP-2S28-95-SC-SD	45/22	0.95/0.35	10	0.38	0/-18	B	173
				IOP-2S28-115-SC-SD	55/27	1.15/0.48		0.46			
F28T5 (25W)											
1	120-277	PS	Optanium	IOP-2S28-115-SC-SD	34/18	1.15/0.48	15	0.31	0/-18	B	170
2				IOP-2S28-95-SC-SD	57/27	0.95/0.35	10	0.47			173
				IOP-2S28-115-SC-SD	67/33	1.15/0.48		0.55			
F28T5 (28W)											
1	120-277	PS	Optanium	IOP-2S28-115-SC-SD	37/19	1.15/0.48	15	0.31	0/-18	B	170
2				IOP-2S28-95-SC-SD	62/30	0.95/0.35	10	0.52			173
				IOP-2S28-115-SC-SD	72/35	1.15/0.48		0.60			
F35T5 (35W)											
1	120-277	PS	Optanium	IOP-2S28-95-SC-SD	38/19	0.95/0.35	15	0.32	0/-18	B	170
				IOP-2S28-115-SC-SD	45/23	1.15/0.48		0.38			
F54T/HO/ES (44W)											
1	120-277	PS	Optanium	IOP-2S54-L-SD	50/49	1.05/1.05	10	0.42-0.20	0/-18	D	170
2				IOP-2S54-L-SD	99/97	1.0/1.0		0.82-0.36			173
F54T5/HO (54W)											
1	120-277	PS	Optanium	IOP-2S54-L-SD	60/60	1.05/1.05	10	0.50-0.23	0/-18	D	170
2				IOP-2S54-L-SD	116/114	1.0/1.0		0.98-0.42			173

* Also available in fixed light output versions. See pages 3-30 and 3-35.

Power Output	Position	
	S1	S2
100%	On	On
50%	On	Off
50%	Off	On
0%	Off	Off

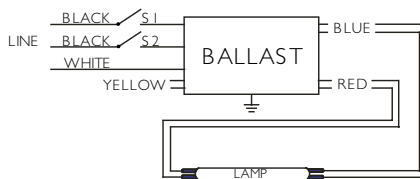

Diag. 170

Line (black) inputs must be connected to the same phase of the line voltage.

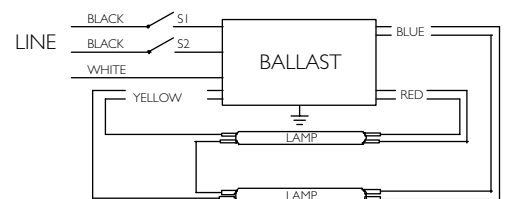

Diag. 173

Line (black) inputs must be connected to the same phase of the line voltage.

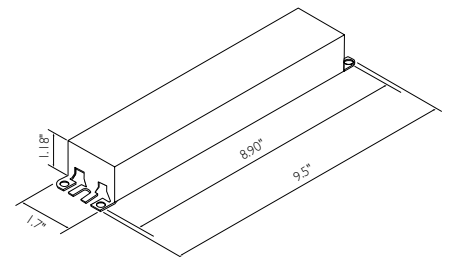

Fig. B

Refer to pages 9-24 to 9-28 for lead length and shipping data.

For 17 - 32W T8 Lamps

HIGH POWER FACTOR SOUND RATED A

Optanium Step-Dim Ballasts



No. of Lamps	Input Volts	Lamp Starting Method	Ballast Family	Catalog Number	Max/Min		Full Light Output		Min. Starting Temp. (°F/°C)	Dim.	Wiring Dia.
					Input Power ANSI (Watts)	Ballast Factor	THD %	Line Current (Amps)			
F17T8, FBO16T8 (17W)											
1	120-277	PS	Optanium	IOP-2S32-SC-SD	15/9	0.87/0.28	10	0.13-0.07	0/-18	B	170A
2				IOP-2S32-SC-SD	28/16	0.87/0.28	10	0.24-0.11	0/-18	B	173A
F25T8, FBO24T8 (25W)											
1	120-277	PS	Optanium	IOP-2S32-SC-SD	22/11	0.87/0.28	10	0.18-0.09	0/-18	B	170A
2				IOP-2S32-SC-SD	40/20	0.87/0.28	10	0.34-0.15	0/-18	B	173A
F32T8/ES (25W - 48")											
2	120-277	PS	Optanium	IOP-2S32-SC-SD	45/22	0.87/0.28	10	0.38-0.17	60/16	B	173A
F32T8/ES (28W - 48")											
2	120-277	PS	Optanium	IOP-2S32-SC-SD	48/23	0.87/0.28	10	0.40-0.18	60/16	B	173A
F32T8, FBO31T8, F32T8/U6 (32W)											
1	120-277	PS	Optanium	IOP-2S32-SC-SD	29/14	0.87/0.28	10	0.24-0.21	0/-18	B	170A
2				IOP-2S32-SC-SD	55/25	0.87/0.28	10	0.47-0.24	0/-18	B	173A

Power Output	Position	
	S1	S2
100%	On	On
50%	On	Off
50%	Off	On
0%	Off	Off

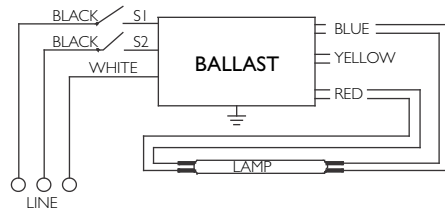

Diag. 170

Line (black) inputs must be connected to the same phase of the line voltage.

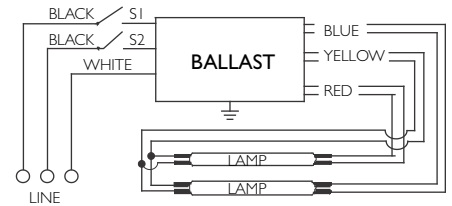

Diag. 173

Line (black) inputs must be connected to the same phase of the line voltage.

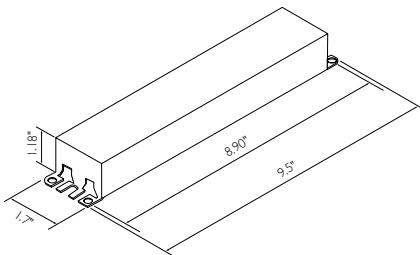

Fig. B

Refer to pages 3-14 to 3-19 for information on remote/tandem wiring and lead length extension.
 Refer to pages 9-24 to 9-28 for lead lengths and shipping data.

Fluorescent Ballasts - Dimming - Mark 10 Powerline

Mark 10 *Powerline* electronic dimming ballasts make converting your existing fixtures easy.

For companies looking to make their fixed-output linear T8, 4-pin CFL and T5/HO fluorescent systems more cost effective and sustainable, Mark 10 *Powerline* ballasts provide an easy solution without the need for additional control leads. Simply replace the ballast, replace the switch and dim the lights. That's all it takes.

It's that easy to bring the convenience and flexibility of fluorescent dimming to conference rooms, private offices, auditoriums, architectural cove lighting – anywhere dimming is required.

Input voltage to dimmer	Control Voltage to Ballast (from Dimmer)	
	Max Light Output	Min Light Output
120V	120V	56V
277V	277V	129V

Compatible with controls from numerous manufacturers without using separate control leads
Powerline dimming interface

Provide task appropriate comfort only where necessary to increase potential energy savings while supporting LEED performance standards
Full range continuous dimming (100% light output down to 5% – T5/HO to 1%)

Ideal for frequent switching applications such as occupancy sensors and daylight harvesting
Programmed start operation



For 18 - 70W T4 Lamps

HIGH POWER FACTOR SOUND RATED A

Mark 10 Powerline Electronic Dimming Ballasts



No. of Lamps	Input Volts	Lamp Starting Method	Ballast Family	Catalog Number	Max/Min		Full Light Output		Min. Starting Temp. (°F/°C)	Dim.	Wiring Dia.					
					Input Power ANSI (Watts)	Ballast Factor	THD %	Line Current (Amps)								
CFQ18W/G24q - 18W CFL Quad Tube Lamp (PL-C18W/4P, F18DBX/4P, CF18DD/E) CFTR18W/GX24q - 18W CFL Triple Tube Lamp (PL-T18W, F18TBX/4P, CF18DT/E)																
1	120	PS	Mark 10 Powerline	REZ-1Q18-M2-BS	22/7	1.00/0.05	10	0.18	50/10	Size 2	138					
	277			VEZ-1Q18-M2-BS				0.07								
2	120			REZ-2Q18-M2-BS	43/14			0.36			138					
	277			VEZ-2Q18-M2-BS				0.16								
CFQ26W/G24q - 26W CFL Quad Tube Lamp (PL-C26W/4P, F26DBX/4P, CF26DD/E) CFTR26W/GX24q - 26W CFL Triple Tube Lamp (PL-T26W, F26TBX/4P, CF26DT/E)																
1	120	PS	Mark 10 Powerline	REZ-1T42-M2-BS	31/8	1.00/0.05	10	0.26	50/10	Size 2	138					
	277			REZ-1T42-M2-LD				0.11								
2	120			REZ-1T42-M2-LD-K	58/16			0.48			138					
	277			VEZ-1T42-M2-BS				0.21								
CFTR32W/GX24q - 32W CFL Triple Tube Lamp (PL-T32W, F32TBX/4P, CF32DT/E)																
1	120	PS	Mark 10 Powerline	REZ-1T42-M2-BS	38/9	1.00/0.05	10	0.32	50/10	Size 2	138					
	277			REZ-1T42-M2-LD				0.14								
2	120			REZ-1T42-M2-LD-K	76/20			0.64		138						
	277			VEZ-1T42-M2-BS				0.28								
CFTR42W/GX24q - 42W CFL Triple Tube Lamp (PL-T42W, F42TBX/4P, CF42DT/E)																
1	120	PS	Mark 10 Powerline	REZ-1T42-M2-BS	49/10	1.00/0.05	10	0.41	50/10	Size 2	138					
	277			REZ-1T42-M2-LD				0.18								
2	120			REZ-1T42-M2-LD-K	98/20			0.82		138						
	277			VEZ-1T42-M2-BS				0.36								
CFTR57W/GX24q - 57W CFL Triple Tube Lamp (PL-T57W, F57QBX/4P, CF57DT/E)																
1	120	PS	Mark 10 Powerline	REZ-2T42-M3-BS	66/18	1.00/0.05	10	0.55	50/10	Size 3	138					
	277			REZ-2T42-M3-LD				0.24								
CFTR70W/GX24q - 70W CFL Triple Tube Lamp (F70QBX/4P, CF70DT/E)																
1	120			PS	Mark 10 Powerline			REZ-2T42-M3-BS		80/18	1.00/0.05	10	0.67	50/10	Size 3	138
	277	REZ-2T42-M3-LD	0.29													

Refer to pages 3-14 to 3-19 for information on remote/tandem wiring and lead length extension.
 Refer to page 4-6 for wiring diagrams and dimensions.
 Refer to page 4-23 for compatible Mark 10 Powerline controls.
 Refer to pages 9-24 to 9-28 for lead lengths and shipping data.

Note: Replacement/Retrofit Ballast Kits indicated by **Bold Type** with suffix -K are available to distributors only. Refer to page 3-21 for details.
 Some lamp manufacturers recommend burning in new lamps 100 hours at full light output before dimming. Consult lamp manufacturer. Ballasts utilizing poke-in connectors can accept wire gauges from AWG 16 - 20.

ONLY USE 4-PIN RAPID-START SOCKETS

For 24 - 55W FT5 Lamps

HIGH POWER FACTOR SOUND RATED A



Mark 10 Powerline Electronic Dimming Ballasts

No. of Lamps	Input Volts	Lamp Starting Method	Ballast Family	Catalog Number	Max/Min		Full Light Output		Min. Starting Temp. (°F/°C)	Dim.	Wiring Dia.
					Input Power ANSI (Watts)	Ballast Factor	THD %	Line Current (Amps)			
FT24W/2G11 - 24/27W Long Twin Tube Lamp (PL-L24W, F27BX/RS, FT24DL)											
2	120-277	PS	Mark 10 Powerline	IEZ-2S24-D	53/11	1.00/0.03	10	0.44-0.18	50/10	D	153
FT36W/2G11 - 36/39W Long Twin Tube Lamp (PL-L36W, F39BX/RS, FT36DL)											
1	120	PS	Mark 10 Powerline	REZ-1TTS40-SC	38/9	1.00/0.05	10	0.32	50/10	B	134
	277			VEZ-1TTS40-SC				0.14			
2	120			REZ-2TTS40-SC	75/16			0.64			132
FT40W/2G11/RS - 40W Long Twin Tube Lamp (PL-L40W, F40BX, FT40DL/RS)											
1	120	PS	Mark 10 Powerline	REZ-1TTS40-SC	43/13	1.00/0.05	10	0.32	50/10	B	134
	277			VEZ-1TTS40-SC				0.15			
2	120			REZ-2TTS40-SC	90/17			0.68			132
FT55W/2G11 - 55W Long Twin Tube Lamp (PL-L55W, F55BX, FT55DL)											
1	120	PS	Mark 10 Powerline	REZ-154	59/13	0.90/0.05	10	0.50	50/10	D	134
	277			VEZ-154				0.22			
2	120			REZ-2S54	114/24			0.96			132
	277			VEZ-2S54							

Burn in new lamps 100 hours at full light before dimming.
Ballasts utilizing poke-in connectors can accept wire gauge AWG 16-20.

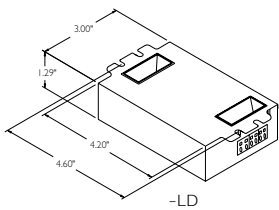

Size 2 Enclosure

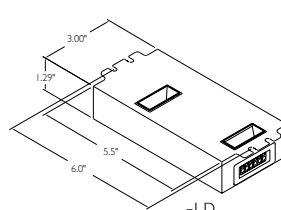
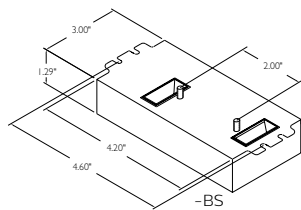

Dual connector for input only

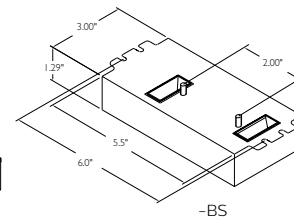

Size 3 Enclosure

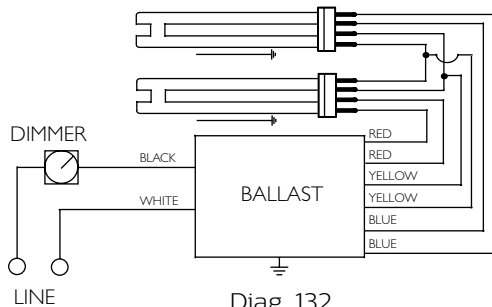

Diag. 132

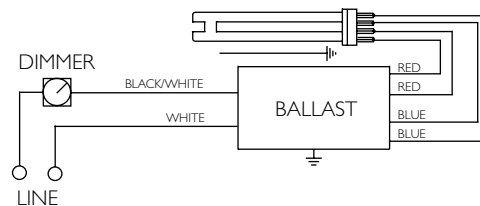

Diag. 134

ONLY USE RAPID-START SOCKETS

Refer to pages 3-14 to 3-19 for information on remote/tandem wiring and lead length extension.
Refer to page 4-7 for additional ballast dimensions and wiring diagrams.
Refer to page 4-23 for compatible Mark 10 Powerline controls.
Refer to pages 9-24 to 9-28 for lead lengths and shipping data.

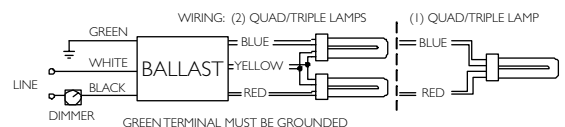

Diag. 138

For 14 - 28W T5 Lamps

HIGH POWER FACTOR SOUND RATED A



Mark 10 Powerline Electronic Dimming Ballasts

No. of Lamps	Input Volts	Lamp Starting Method	Ballast Family	Catalog Number	Max/Min		Full Light Output		Min. Starting Temp. (°F/°C)	Dim.	Wiring Dia.
					Input Power ANSI (Watts)	Ballast Factor	THD %	Line Current (Amps)			
F14T5 (14W)											
1	120-277	PS	Mark 10 Powerline	IEZ-128-D	17/6	1.03/0.03	15	0.14-0.06	50/10	D	152
2				IEZ-2S28-D	32/9	1.03/0.03	10	0.27-0.12	50/10	D	153
F21T5 (21W)											
1	120-277	PS	Mark 10 Powerline	IEZ-128-D	24/6	1.00/0.03	10	0.21-0.08	50/10	D	152
2				IEZ-2S28-D	48/9	1.00/0.03	10	0.38-0.16	50/10	D	153
F28T5 (25W)											
1	120-277	PS	Mark 10 Powerline	IEZ-128-D	29/6	1.00/0.03	10	0.25-0.10	50/10	D	152
2				IEZ-2S28-D	59/10	1.00/0.03	10	0.49-0.20	50/10	D	153
F28T5 (28W)											
1	120-277	PS	Mark 10 Powerline	IEZ-128-D	31/6	1.00/0.03	10	0.26-0.11	50/10	D	152
2				IEZ-2S28-D	63/10	1.00/0.03	10	0.53-0.22	50/10	D	153

Some lamp manufacturers recommend burning in new lamps 100 hours at full light output before dimming. Consult lamp manufacturer.
 Ballasts utilizing poke-in connectors can accept wire gauge AWG 16-20.

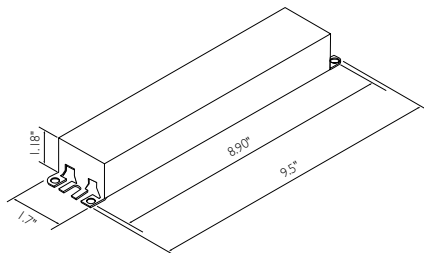
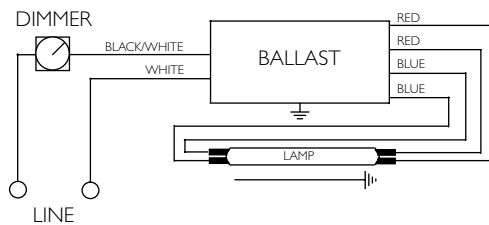

Fig. B



Diag. 152

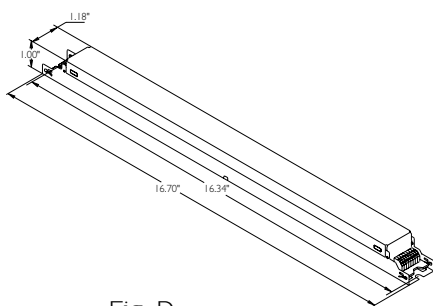
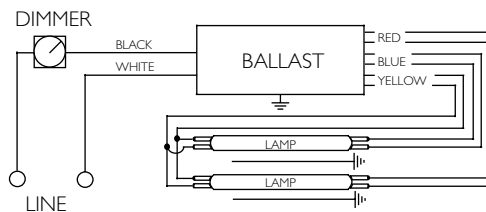

Fig. D

Includes connectors with no leads



Diag. 153

ONLY USE RAPID-START SOCKETS

Refer to pages 3-14 to 3-19 for information on remote/tandem wiring and lead length extension.
 Refer to pages 4-23 for compatible Mark 10 Powerline controls.
 Refer to pages 9-24 to 9-28 for lead lengths and shipping data.

For 24 – 55W T5/HO Lamps

HIGH POWER FACTOR SOUND RATED A

Mark 10 Powerline Electronic Dimming Ballasts



No. of Lamps	Input Volts	Lamp Starting Method	Ballast Family	Catalog Number	Max/Min		Full Light Output		Min. Starting Temp. (°F/°C)	Dim.	Wiring Dia.
					Input Power ANSI (Watts)	Ballast Factor	THD %	Line Current (Amps)			
F24T5/HO (24W)											
2	120-277	PS	Mark 10 Powerline	IEZ-2S24-D	53/11	1.00/0.03	10	0.44-0.18	50/10	D	153
F39T5/HO (39W)											
2	120-277	PS	Mark 10 Powerline	IEZ-2S24-D	84/11	0.85/0.03	10	0.70-0.29	50/10	D	153
F54T5/HO/ES (49W)											
1	120	PS	Mark 10 Powerline	REZ-154	59/13	1.00/0.03	10	0.49	50/10	D	152
	277			VEZ-154				0.21			
2	120			REZ-2S54	117/24			0.98			
	277			VEZ-2S54				0.42			
F54T5/HO (54W)											
1	120	PS	Mark 10 Powerline	REZ-154	63/13	1.00/0.03	10	0.53	50/10	D	152
	277			VEZ-154				0.23			
2	120			REZ-2S54	125/24			1.05			
	277			VEZ-2S54				0.45			
FC12T5/HO (55W)											
1	120	PS	Mark 10 Powerline	REZ-154	59/13	0.90/0.03	10	0.50	50/10	D	152
	277			VEZ-154				0.22			
2	120			REZ-2S54	114/24			0.96			
	277			VEZ-2S54				0.42			

Some lamp manufacturers recommend burning in new lamps 100 hours at full light output before dimming. Consult lamp manufacturer.
Ballasts utilizing poke-in connectors can accept wire gauge AWG 16-20.

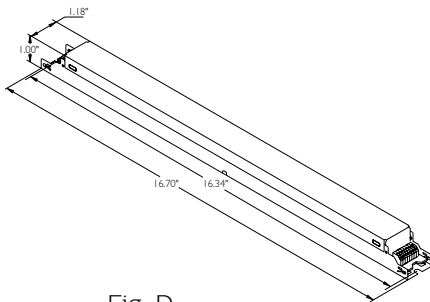
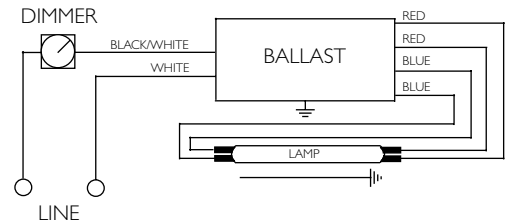

Fig. D

Includes connectors with no leads

ONLY USE RAPID-START SOCKETS

Refer to pages 3-14 to 3-19 for information on remote/tandem wiring and lead length extension.
Refer to pages 4-23 for compatible Mark 10 Powerline controls.
Refer to pages 9-24 to 9-28 for lead lengths and shipping data.



Diag. 152

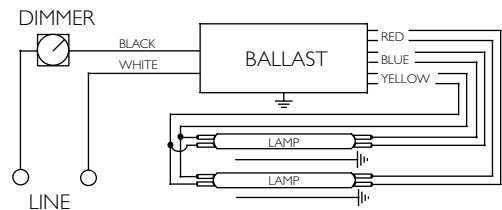

Diag. 153

For 17 - 32W T8 Lamps

HIGH POWER FACTOR SOUND RATED A

Mark 10 Powerline Electronic Dimming Ballasts



No. of Lamps	Input Volts	Lamp Starting Method	Ballast Family	Catalog Number	Max/Min		Full Light Output		Min. Starting Temp. (°F/°C)	Dim.	Wiring Dia.
					Input Power ANSI (Watts)	Ballast Factor	THD %	Line Current (Amps)			
F17T8, FBO16T8 (17W)											
1	120	PS	Mark 10 Powerline	REZ-132-SC	24/7	1.05/0.05	10	0.20	50/10	B	152
	277			VEZ-132-SC				0.09			
2	120			REZ-2S32-SC	38/13			0.32			153
	277			VEZ-2S32-SC				0.14			
3	120			REZ-3S32-SC	56/18			0.47			155
	277			VEZ-3S32-SC				0.21			
F25T8, FBO24T8 (25W)											
1	120	PS	Mark 10 Powerline	REZ-132-SC	30/7	1.05/0.05	10	0.26	50/10	B	152
	277			VEZ-132-SC				0.11			
2	120			REZ-2S32-SC	55/13			0.46			153
	277			VEZ-2S32-SC				0.20			
3	120			REZ-3S32-SC	79/19			0.66			155
	277			VEZ-3S32-SC				0.29			
F32T8, FBO31T8, F32T8/U6 (32W)											
1	120	PS	Mark 10 Powerline	REZ-132-SC	35/9	1.00/0.05	10	0.29	50/10	B	152
	277			VEZ-132-SC				0.13			
2	120			REZ-2S32-SC	68/15			0.57			153
	277			VEZ-2S32-SC				0.25			
3	120			REZ-3S32-SC	96/20			0.80			155
	277			VEZ-3S32-SC				0.35			

Some lamp manufacturers recommend burning in new lamps 100 hours at full light output before dimming. Consult lamp manufacturer.

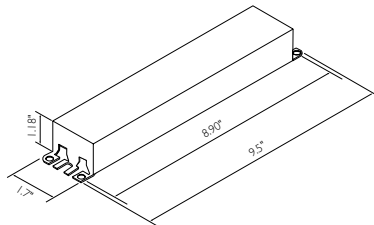
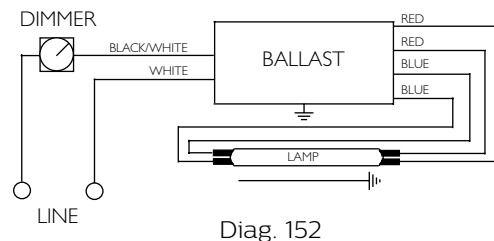
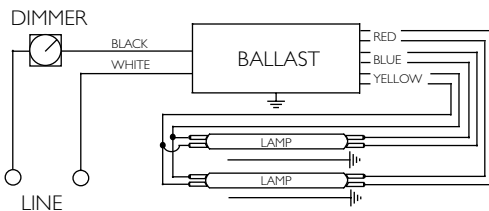

Fig. B



Diag. 152



Diag. 153

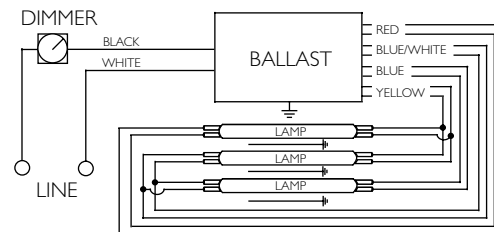

Diag. 155

Refer to pages 3-14 to 3-19 for information on remote/tandem wiring and lead length extension.

Refer to pages 4-23 for compatible Mark 10 Powerline controls.

Refer to pages 9-24 to 9-28 for lead lengths and shipping data.

ONLY USE RAPID-START SOCKETS

Fluorescent Ballasts - Dimming - Mark 7 0-10V

0-10V electronic dimming ballasts provide maximum versatility with low voltage dimming.

The Mark 7 0-10V series of dimmable electronic ballasts offer maximum versatility by incorporating separate control leads for use with a wide array of controllers, including occupancy sensors, daylight harvesting controls, and building management systems from more than 40 manufacturers.

When paired with linear fluorescent and 4-pin compact fluorescent lamps, Mark 7 0-10V ballasts optimize the benefits of such popular sustainable lighting techniques as daylight harvesting, occupancy sensors, and load shedding to satisfy the need for an affordable, flexible and versatile controllable lighting solution.

Mark 7 0-10V Control Wiring (Grey and Violet)

Wire Size	Maximum Length (Ft.)
AWG-16	800
AWG-18	500
AWG-20	320

Provide task appropriate comfort only where necessary to increase potential energy savings while supporting LEED performance standards
Full range continuous dimming (100% light output down to 3% - T5/HO to 1%)

Help reduce maintenance costs as more lamps remain on when lamps reach end-of-life minimizing wasteful re-lamping
Independent light operation (4-Lamp)

Ideal for frequent switching applications such as occupancy sensors and daylight harvesting
Programmed start operation



Note: Easy way to test dimming functionality of 0-10V dimming ballasts is to 'short' together the violet and grey control wires. If the lamps go to full dim, then the ballast is dimming fine.

For 13 - 70W T4 Lamps

HIGH POWER FACTOR SOUND RATED A



Mark 7 0-10V Electronic Dimming Ballasts

No. of Lamps	Input Volts	Lamp Starting Method	Ballast Family	Catalog Number	Max/Min		Full Light Output		Min. Starting Temp. (°F/°C)	Dim.	Wiring Dia.
					Input Power ANSI (Watts)	Ballast Factor	THD %	Line Current (Amps)			
CFQ13W/G24q - 13W CFL Quad Tube Lamp (PL-C13W/4P, F13DBX/4P, CF13DD/E) CFTR13W/GX24q - 13W CFL Triple Tube Lamp (F13TBX/4P, CF13DT/E)											
1	120-277	PS	Mark 7 0-10V	IZT-2S26-M5-BS	18/6	1.00/0.03	10	0.15-0.07	50/10	Size 5	166
2				IZT-2S26-M5-LD	33/19			0.28-0.12			166
CFQ18W/G24q - 18W CFL Quad Tube Lamp (PL-C18W/4P, F18DBX/4P, CF18DD/E) CFTR18W/GX24q - 18W CFL Triple Tube Lamp (PL-T18W, F18TBX/4P, CF18DT/E)											
1	120-277	PS	Mark 7 0-10V	IZT-2S26-M5-BS	23/7	1.00/0.03	10	0.19-0.09	50/10	Size 5	166
2				IZT-2S26-M5-LD	41/11			0.34-0.15			166
CFQ26W/G24q - 26W CFL Quad Tube Lamp (PL-C26W/4P, F26DBX/4P, CF26DD/E) CFTR26W/GX24q - 26W CFL Triple Tube Lamp (PL-T26W, F26TBX/4P, CF26DT/E)											
1	120-277	PS	Mark 7 0-10V	IZT-2S26-M5-BS	30/8	1.00/0.03	10	0.25-0.11	50/10	Size 5	166
2				IZT-2S26-M5-LD	55/13			0.46-0.20			166
CFTR32W/GX24q - 32W CFL Triple Tube Lamp (PL-T32W, F32TBX/4P, CF32DT/E)											
1	120-277	PS	Mark 7 0-10V	IZT-2S26-M5-BS	36/9	1.00/0.03	10	0.30-0.13	50/10	Size 5	166
2				IZT-2T42-M5-BS	75/19			0.63-0.21			166
CFTR42W/GX24q - 42W CFL Triple Tube Lamp (PL-T42W, F42TBX/4P, CF42DT/E)											
1	120-277	PS	Mark 7 0-10V	IZT-2S26-M5-BS	47/9	1.00/0.03	10	0.39-0.17	50/10	Size 5	166
2				IZT-2T42-M5-BS	98/18			0.82-0.36			166
CFTR57W/GX24q - 57W CFL Triple Tube Lamp (PL-T57W, F57QBX/4P, CF57DT/E)											
1	120-277	PS	Mark 7 0-10V	IZT-2T42-M5-BS	65/16	1.00/0.03	10	0.55-0.24	50/10	Size 5	166
CFTR70W/GX24q - 70W CFL Triple Tube Lamp (F70QBX/4P, CF70DT/E)											
1	120-277	PS	Mark 7 0-10V	IZT-2T42-M5-BS	75/16	1.00/0.03	10	0.63-0.27	50/10	Size 5	166

Some lamp manufacturers recommend burning in new lamps 100 hours at full light output before dimming. Consult lamp manufacturer.
 Ballasts utilizing poke-in connectors can accept wire gauges from AWG 16 - 20.

ONLY USE 4-PIN RAPID-START SOCKETS

Refer to pages 3-14 to 3-19 for information on remote/tandem wiring and lead length extension.
 Refer to pages 4-12 for wiring diagrams and dimensions.
 Refer to pages 4-23 for compatible Mark 7 0-10V controls.
 Refer to pages 9-24 to 9-28 for lead lengths and shipping data.

For 36 – 80W FT5 Lamps

HIGH POWER FACTOR SOUND RATED A



Mark 7 0-10V Electronic Dimming Ballasts

No. of Lamps	Input Volts	Lamp Starting Method	Ballast Family	Catalog Number	Max/Min		Full Light Output		Min. Starting Temp. (°F/°C)	Dim.	Wiring Dia.
					Input Power ANSI (Watts)	Ballast Factor	THD %	Line Current (Amps)			
FT36W/2G11 – 36/39W Long Twin Tube Lamp (PL-L36W, F39BX/RS, FT36DL)											
2	120-277	PS	Mark 7 0-10V	IZT-2TTS40-SC	75/16	1.00/0.03	10	0.64-0.27	50/10	B	59A
FT40W/2G11/RS – 40W Long Twin Tube Lamp (PL-L40W, F40BX, FT40DL/RS)											
2	120-277	PS	Mark 7 0-10V	IZT-2TTS40-SC	90/16	1.00/0.03	10	0.64-0.28	50/10	B	59A
FT55W/2G11 – 55W Long Twin Tube Lamp (PL-L55W, F55BX, FT55DL)											
1	120-277	PS	Mark 7 0-10V	IZT-154-D	49/9	0.80/0.03	10	0.33-0.14	50/10	D	58A
2				IZT-2S54-D	108/16			0.90-0.38			59A
FT80W/2G11 – 80W Long Twin Tube Lamp (PL-L80W, FT80DL)											
1	120-277	PS	Mark 7 0-10V	IZT-180-D	94/16	1.00/0.03	10	0.79-0.33	50/10	D	58A

Burn in new lamps 100 hours at full light output before dimming.
Ballasts utilizing poke-in connectors can accept wire gauge AWG 16-20.

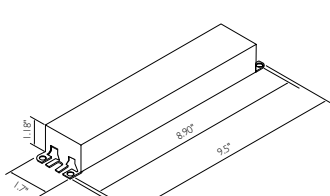

Fig. B

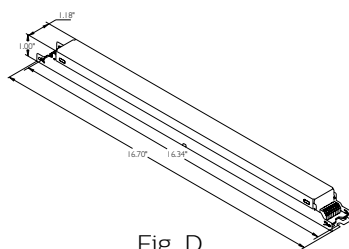
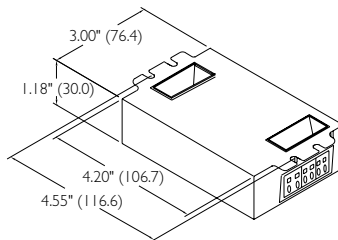
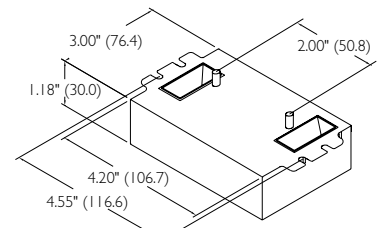

Fig. D
Includes connectors with no leads



-LD



-BS

Size 5 Enclosure

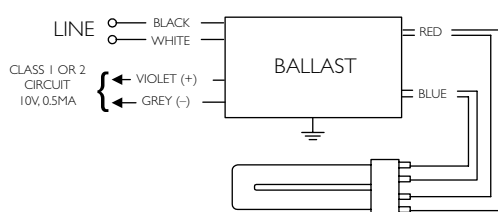

Diag. 58A

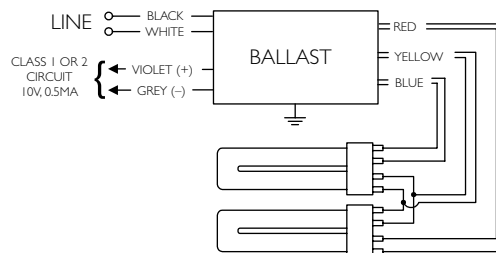

Diag. 59A

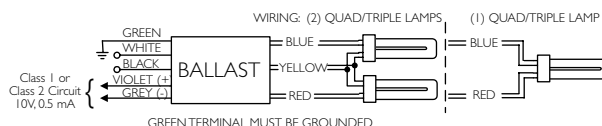

Diag. 166

ONLY USE RAPID-START SOCKETS

Refer to pages 3-14 to 3-19 for information on remote/tandem wiring and lead length extension.

Refer to pages 4-23 for compatible Mark 7 0-10V controls.

Refer to pages 9-24 to 9-28 for lead lengths and shipping data.

For 14 - 28W T5 Lamps

HIGH POWER FACTOR SOUND RATED A

Mark 7 0-10V Electronic Dimming Ballasts



No. of Lamps	Input Volts	Lamp Starting Method	Ballast Family	Catalog Number	Max/Min		Full Light Output		Min. Starting Temp. (°F/°C)	Dim.	Wiring Dia.
					Input Power ANSI (Watts)	Ballast Factor	THD %	Line Current (Amps)			
F14T5 (14W)											
1	120-277	PS	Mark 7 0-10V	IZT-128-D	19/6	1.00/0.03	10	0.15-0.07	50/10	D	55A
2				IZT-2S28-D	34/9			0.29-0.12			56A
F21T5 (21W)											
1	120-277	PS	Mark 7 0-10V	IZT-128-D	25/6	1.00/0.03	10	0.20-0.09	50/10	D	55A
2				IZT-2S28-D	49/10			0.42-0.18			56A
F28T5 (25W)											
1	120-277	PS	Mark 7 0-10V	IZT-128-D	30/7	1.00/0.03	10	0.25-0.11	50/10	D	55A
2				IZT-2S28-D	59/12			0.51-0.21			56A
F28T5 (28W)											
1	120-277	PS	Mark 7 0-10V	IZT-128-D	32/7	1.00/0.03	10	0.27-0.12	50/10	D	55A
2				IZT-2S28-D	63/12			0.57-0.22			56A

Ballasts utilizing poke-in connectors can accept wire gauge AWG 16-20.
 Some lamp manufacturers recommend burning in new lamps 100 hours at full light output prior to dimming. Consult lamp manufacturer.

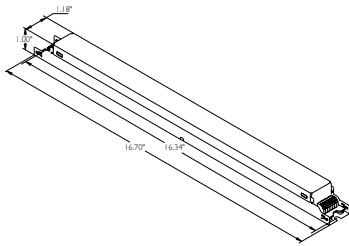
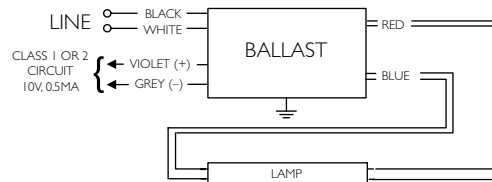
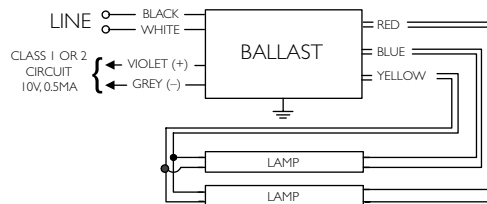

Fig. D

Includes connectors with no leads



Diag. 55A



Diag. 56A

ONLY USE RAPID-START SOCKETS

Refer to pages 3-14 to 3-19 for information on remote/tandem wiring and lead length extension.
 Refer to pages 4-23 for compatible Mark 7 0-10V controls.
 Refer to pages 9-24 to 9-28 for lead lengths and shipping data.

For 24 – 80W T5/HO Lamps

HIGH POWER FACTOR SOUND RATED A

Mark 7 0-10V Electronic Dimming Ballasts



No. of Lamps	Input Volts	Lamp Starting Method	Ballast Family	Catalog Number	Max/Min		Full Light Output		Min. Starting Temp. (°F/°C)	Dim.	Wiring Dia.
					Input Power ANSI (Watts)	Ballast Factor	THD %	Line Current (Amps)			
F24T5/HO (24W)											
1	120-277	PS	Mark 7 0-10V	IZT-124-D	25/8	1.00/0.03	10	0.21-0.09	50/10	D	55A
2	120-277			IZT-2S24-D	53/11			0.44-0.18			56A
F39T5/HO (39W)											
1	120-277	PS	Mark 7 0-10V	IZT-124-D	40/8	1.00/0.03	10	0.34-0.14	50/10	D	55A
2				IZT-2S24-D	84/11			0.70-0.29			56A
F54T5/HO/ES (49W)											
1	120-277	PS	Mark 7 0-10V	IZT-154-D	54/9	1.00/0.03	10	0.46-0.19	60/16	D	55A
2				IZT-2S54-D	109/16			0.91-0.38			56A
F54T5/HO (54W)											
1	120-277	PS	Mark 7 0-10V	IZT-154-D	56/10	1.00/0.03	10	0.46-0.20	50/10	D	55A
2				IZT-2S54-D	118/16			0.98-0.41			56A
F80T5/HO (80W)											
1	120-277	PS	Mark 7 0-10V	IZT-180-D	94/18	1.00/0.03	10	0.73-0.30	50/10	D	55A
FC12T5/HO (55W)											
1	120-277	PS	Mark 7 0-10V	IZT-154-D	47/9	0.90/0.03	10	0.40-0.17	50/10	D	55A
2				IZT-2S54-D	98/18			0.82-0.35			56A

Some lamp manufacturers recommend burning in new lamps 100 hours at full light output before dimming. Consult lamp manufacturer.
Ballasts utilizing poke-in connectors can accept wire gauges from AWG 16 - 20.

ONLY USE RAPID-START SOCKETS

Refer to pages 3-14 to 3-19 for information on remote/tandem wiring and lead length extension.
Refer to pages 4-16 for wiring diagrams and dimensions.
Refer to pages 4-23 for compatible Mark 7 0-10V controls.
Refer to pages 9-24 to 9-28 for lead lengths and shipping data.

For 17 – 32W T8 Lamps

HIGH POWER FACTOR SOUND RATED A

Mark 7 0-10V Electronic Dimming Ballasts



No. of Lamps	Input Volts	Lamp Starting Method	Ballast Family	Catalog Number	Max/Min		Full Light Output		Min. Starting Temp. (°F/°C)	Dim.	Wiring Dia.				
					Input Power ANSI (Watts)	Ballast Factor	THD %	Line Current (Amps)							
F17T8, FBO16T8 (17W)															
1	120-277	PS	Mark 7 0-10V	IZT-132-SC	19/6	1.00/0.03	10	0.16-0.07	50/10	B	55A				
2	347			IZT-2PSP32-SC	35/10			0.28-0.12			56A				
3	120-277			GZT-2S32-SC	32/14	0.90/0.05		0.10			57D				
				IZT-3PSP32-SC	52/17	1.00/0.05		0.44-0.19			57C				
	347			GZT-3S32-SC	48/19	0.90/0.05		0.14			57C				
F25T8, FBO24T8 (25W)															
1	120-277	PS	Mark 7 0-10V	IZT-132-SC	27/7	0.98/0.03	10	0.23-0.10	50/10	B	55A				
2	347			IZT-2PSP32-SC	50/11			0.41-0.18			56A				
3	120-277			GZT-2S32-SC	47/14	0.90/0.05		0.14			57D				
				IZT-3PSP32-SC	73/16	1.00/0.03		0.61-0.26			57C				
	347			GZT-3S32-SC	68/18	0.90/0.05		0.20		57C					
				120-277	IZT-4S32	96/22		0.88/0.05		0.77-0.35	D	16A			
F32T8, FBO31T8, F32T8/U6 (32W)															
1	120-277			PS	Mark 7 0-10V	IZT-132-SC		35/8		1.00/0.03	10	0.30-0.13	50/10	B	55A
2	347	IZT-2PSP32-SC	68/14			0.54-0.18	56A								
3	120-277	GZT-2S32-SC	61/15			0.90/0.05	0.18	57D							
		IZT-3PSP32-SC	94/16			1.00/0.03	0.79-0.33	57C							
	347	GZT-3S32-SC	90/19			0.90/0.05	0.27	57C							
		277	VZT-4S32-HL			149/27	1.00/0.03	0.54	G	16A					
4	120-277	IZT-4PSP32-G	111/24			0.88/0.05	0.95-0.40	G	174A						
		IZT-4S32	116/25			0.88/0.05	0.98-0.42	D	16A						

Some lamp manufacturers recommend burning in new lamps 100 hours at full light output before dimming. Consult lamp manufacturer.
 Ballasts utilizing poke-in connectors can accept wire gauges from AWG 16 - 20.

ONLY USE RAPID-START SOCKETS

Refer to pages 3-14 to 3-19 for information on remote/tandem wiring and lead length extension.
 Refer to pages 4-16 for wiring diagrams and dimensions.
 Refer to pages 4-23 for compatible Mark 7 0-10V controls.
 Refer to pages 9-24 to 9-28 for lead lengths and shipping data.

Mark 7 0-10V Wiring Diagrams and Dimensions

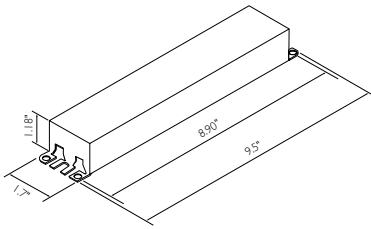

Fig. B

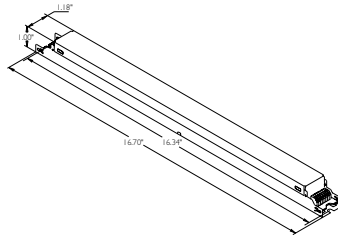

Fig. D
Includes connectors with no leads

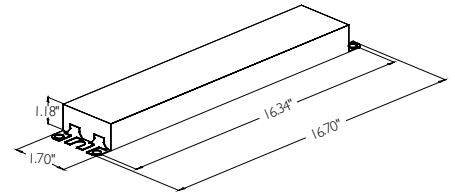
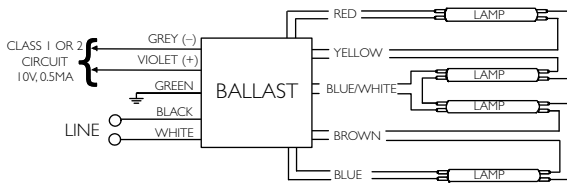
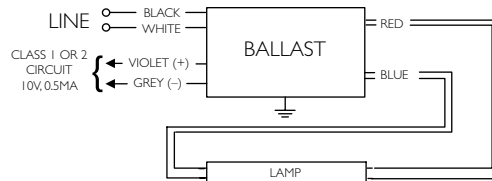

Fig. G



Diag. 16A



Diag. 55A

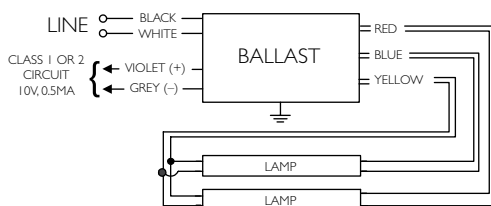

Diag. 56A

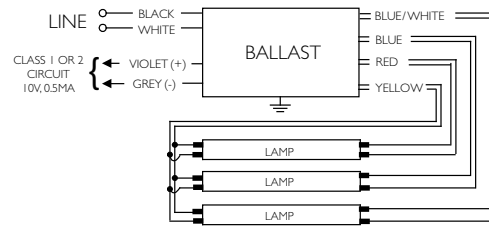

Diag. 57D

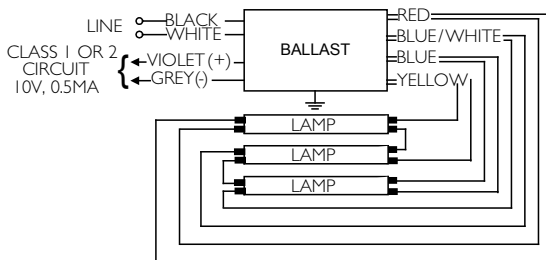

Diag. 57C

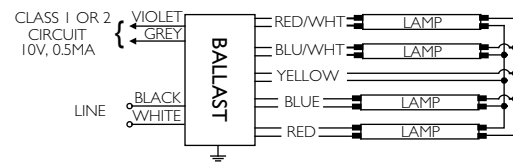

Diag. 174A

ONLY USE RAPID-START SOCKETS

Refer to pages 3-14 to 3-19 for information on remote/tandem wiring and lead length extension.

Refer to pages 4-23 for compatible Mark 7 0-10V controls.

Refer to pages 9-24 to 9-28 for lead lengths and shipping data.

Fluorescent Ballasts - Dimming - ROVR

Digital addressable ballasts provide intelligent control through the DALI protocol.

Philips Advance ROVR ballasts reflect the latest approach to controlling fluorescent lighting. Rather than simply responding to instructions from control components, ROVR ballasts enable two-way communication and have the ability to dim and switch individual ballasts through the control signal.

These features allow for virtually unlimited design flexibility while creating sustainable lighting systems. This two-way communication is made possible through the industry-standard digital communication protocol known as DALI (Digital Addressable Lighting Interface).

This protocol allows ROVR ballasts to provide users with operational data while controlling the output of individual luminaires. This fully supports sustainable design principles such as daylight harvesting and occupancy sensors while enabling a proactive response to maintenance concerns.

Ideal for a variety of applications

Available in linear fluorescent and 4-pin compact fluorescent models

Provide task appropriate comfort only where necessary to increase potential energy savings while supporting LEED performance standards

Full range continuous dimming (100% light output down to 3% - T5/HO to 1%)

Ideal for frequent switching applications such as occupancy sensors and daylight harvesting

Programmed start operation



For 13 - 70W T4 Lamps

HIGH POWER FACTOR SOUND RATED A



ROVR Digital Addressable Ballasts

No. of Lamps	Input Volts	Lamp Starting Method	Ballast Family	Catalog Number	Max/Min		Full Light Output		Min. Starting Temp. (°F/°C)	Dim.	Wiring Dia.
					Input Power ANSI (Watts)	Ballast Factor	THD %	Line Current (Amps)			
CFQ13W/G24q - 13W CFL Quad Tube Lamp (PL-C13W/4P, F13DBX/4P, CF13DD/E) CFTR13W/GX24q - 13W CFL Triple Tube Lamp (F13TBX/4P, CF13DT/E)											
1	120-277	PS	ROVR	IDL-2S26-M5-BS IDL-2S26-M5-LD	18/6	1.00/0.03	10	0.15-0.07	50/10	Size 5	165
2				IDL-2S26-M5-BS IDL-2S26-M5-LD	33/19			0.28-0.12			165
CFQ18W/G24q - 18W CFL Quad Tube Lamp (PL-C18W/4P, F18DBX/4P, CF18DD/E) CFTR18W/GX24q - 18W CFL Triple Tube Lamp (PL-T18W, F18TBX/4P, CF18DT/E)											
1	120-277	PS	ROVR	IDL-2S26-M5-BS IDL-2S26-M5-LD	23/7	1.00/0.03	10	0.19-0.09	50/10	Size 5	165
2				IDL-2S26-M5-BS IDL-2S26-M5-LD	41/11			0.34-0.15			165
CFQ26W/G24q - 26W CFL Quad Tube Lamp (PL-C26W/4P, F26DBX/4P, CF26DD/E) CFTR26W/GX24q - 26W CFL Triple Tube Lamp (PL-T26W, F26TBX/4P, CF26DT/E)											
1	120-277	PS	ROVR	IDL-2S26-M5-BS IDL-2S26-M5-LD	30/8	1.00/0.03	10	0.25-0.11	50/10	Size 5	165
2				IDL-2S26-M5-BS IDL-2S26-M5-LD	55/13			0.46-0.20			165
CFTR32W/GX24q - 32W CFL Triple Tube Lamp (PL-T32W, F32TBX/4P, CF32DT/E)											
1	120-277	PS	ROVR	IDL-2S26-M5-BS IDL-2S26-M5-LD	36/9	1.00/0.03	10	0.30-0.13	50/10	Size 5	165
2				IDL-2T42-M5-BS IDL-2T42-M5-LD	75/19			0.63-0.21			165
CFTR42W/GX24q - 42W CFL Triple Tube Lamp (PL-T42W, F42TBX/4P, CF42DT/E)											
1	120-277	PS	ROVR	IDL-2S26-M5-BS IDL-2S26-M5-LD	47/9	1.00/0.03	10	0.39-0.17	50/10	Size 5	165
2				IDL-2T42-M5-BS IDL-2T42-M5-LD	98/18			0.82-0.36			165
CFTR57W/GX24q - 57W CFL Triple Tube Lamp (PL-T57W, F57QBX/4P, CF57DT/E)											
1	120-277	PS	ROVR	IDL-2T42-M5-BS IDL-2T42-M5-LD	65/16	1.00/0.03	10	0.55-0.24	50/10	Size 5	165
CFTR70W/GX24q - 70W CFL Triple Tube Lamp (F70QBX/4P, CF70DT/E)											
1	120-277	PS	ROVR	IDL-2T42-M5-BS IDL-2T42-M5-LD	75/16	1.00/0.03	10	0.63-0.27	50/10	Size 5	165

Some lamp manufacturers recommend burning in new lamps 100 hours at full light output before dimming. Consult lamp manufacturer.
Ballasts utilizing poke-in connectors can accept wire gauges from AWG 16 - 20.

ONLY USE 4-PIN RAPID-START SOCKETS

Refer to pages 3-14 to 3-19 for information on remote/tandem wiring and lead length extension.
Refer to pages 4-19 for wiring diagrams and dimensions.
Refer to pages 4-23 for compatible ROVR controls.
Refer to pages 9-24 to 9-28 for lead lengths and shipping data.

For 55W FT5 Lamps

HIGH POWER FACTOR SOUND RATED A

ROVR Digital Addressable Ballasts



No. of Lamps	Input Volts	Lamp Starting Method	Ballast Family	Catalog Number	Max/Min		Full Light Output		Min. Starting Temp. (°F/°C)	Dim.	Wiring Dia.
					Input Power ANSI (Watts)	Ballast Factor	THD %	Line Current (Amps)			
FT55W/2G11 - 55W Long Twin Tube Lamp (PL-L55W, F55BX, FT55DL)											
1	120-277	PS	ROVR	IDA-154	59/13	0.90/0.03	10	0.50-0.22	50/10	D	58B
2				IDA-2S54	114/24			0.96-0.42			59B

Some lamp manufacturers recommend burning in new lamps 100 hours at full light output before dimming. Consult lamp manufacturer.
 Ballasts utilizing poke-in connectors can accept wire gauges from AWG 16 - 20.

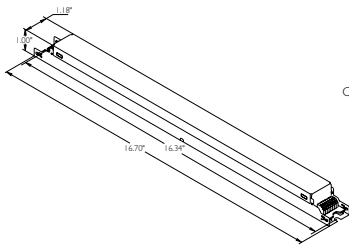
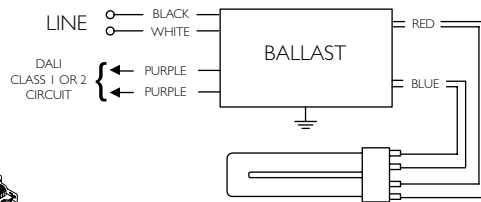
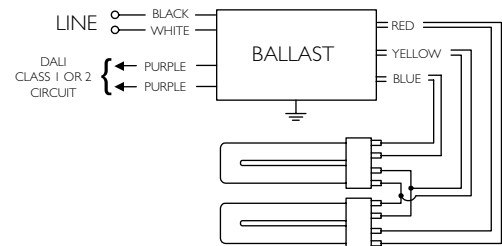

Fig. D

Includes connectors with no leads



Diag. 58B



Diag. 59B

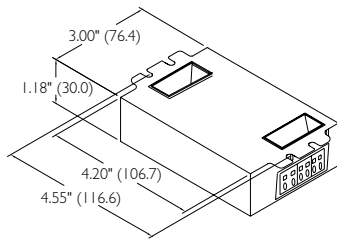

-LD

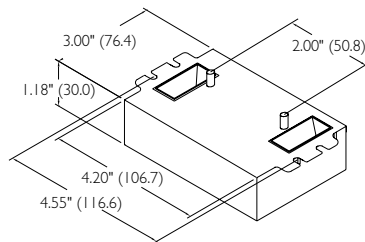

-BS

Size 5

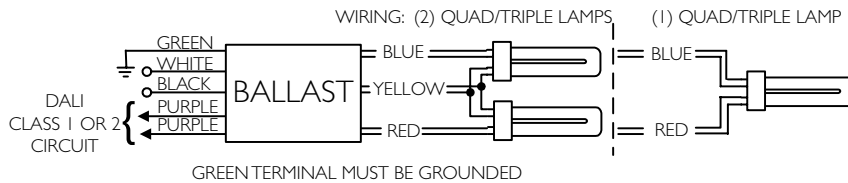

Diag. 165

ONLY USE RAPID-START SOCKETS

Refer to pages 4-23 to 4-24 for information on remote/tandem wiring and lead length extension.

Refer to pages 4-23 for compatible ROVR controls.

Refer to pages 9-24 to 9-28 for lead lengths and shipping data.

For 14 – 28W T5 Lamps

HIGH POWER FACTOR SOUND RATED A

ROVR Digital Addressable Ballasts



No. of Lamps	Input Volts	Lamp Starting Method	Ballast Family	Catalog Number	Max/Min		Full Light Output		Min. Starting Temp. (°F/°C)	Dim.	Wiring Dia.
					Input Power ANSI (Watts)	Ballast Factor	THD %	Line Current (Amps)			
F14T5 (14W)											
1	120-277	PS	ROVR	IDA-128-D	19/6	1.00/0.03	10	0.15-0.07	50/10	D	55B
2				IDA-2S28-D	34/9			0.29-0.12			56B
F21T5 (21W)											
1	120-277	PS	ROVR	IDA-128-D	25/6	1.00/0.03	10	0.20-0.09	50/10	D	55B
2				IDA-2S28-D	49/10			0.42-0.18			56B
F28T5 (25W)											
1	120-277	PS	ROVR	IDA-128-D	30/7	1.00/0.03	10	0.25-0.11	50/10	D	55B
2				IDA-2S28-D	59/12			0.51-0.21			56B
F28T5 (28W)											
1	120-277	PS	ROVR	IDA-128-D	32/7	1.00/0.03	10	0.27-0.12	50/10	D	55B
2				IDA-2S28-D	63/12			0.57-0.22			56B

Ballasts utilizing poke-in connectors can accept wire gauge AWG 16-20.

Some lamp manufacturers recommend burning in new lamps 100 hours at full light output prior to dimming. Consult lamp manufacturer.

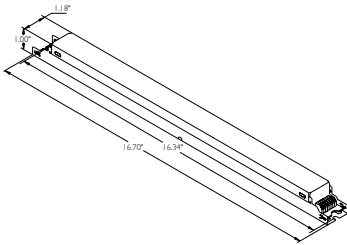
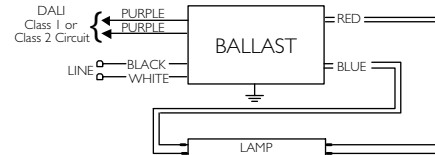
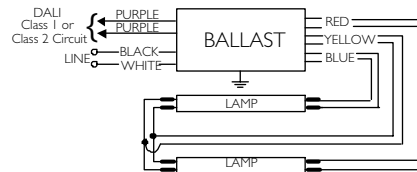

Fig. D

Includes connectors with no leads



Diag. 55B



Diag. 56B

ONLY USE RAPID-START SOCKETS

Refer to pages 3-14 to 3-19 for information on remote/tandem wiring and lead length extension.

Refer to pages 4-23 for compatible ROVR controls.

Refer to pages 9-24 to 9-28 for lead lengths and shipping data.

For 49 - 55W T5/HO Lamps

HIGH POWER FACTOR SOUND RATED A

ROVR Digital Addressable Ballasts



No. of Lamps	Input Volts	Lamp Starting Method	Ballast Family	Catalog Number	Max/Min		Full Light Output		Min. Starting Temp. (°F/°C)	Dim.	Wiring Dia.
					Input Power ANSI (Watts)	Ballast Factor	THD %	Line Current (Amps)			
F54T5/HO/ES (49W)											
1	120-277	PS	ROVR	IDA-154	59/13	1.00/0.03	10	0.49-0.21	50/10	D	55B
2				IDA-2S54	117/24			0.98-0.42			56B
F54T5/HO (54W)											
1	120-277	PS	ROVR	IDA-154	63/13	1.00/0.03	10	0.53-0.23	50/10	D	55B
2				IDA-2S54	125/24			1.05-0.45			56B
FC12T5/HO (55W)											
1	120-277	PS	ROVR	IDA-154	59/13	0.90/0.03	10	0.50-0.22	50/10	D	55B
2				IDA-2S54	114/24			0.96-0.42			56B

Some lamp manufacturers recommend burning in new lamps 100 hours at full light output before dimming. Consult lamp manufacturer.
 Ballasts utilizing poke-in connectors can accept wire gauges from AWG 16 - 20.

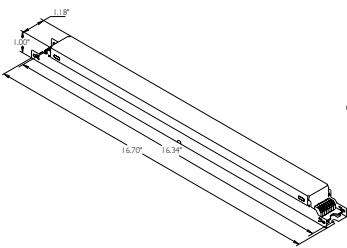
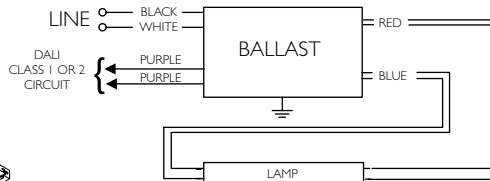
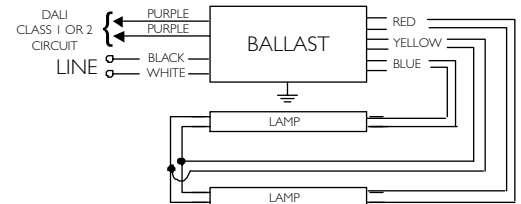

Fig. D

Includes connectors with no leads



Diag. 55B



Diag. 56B

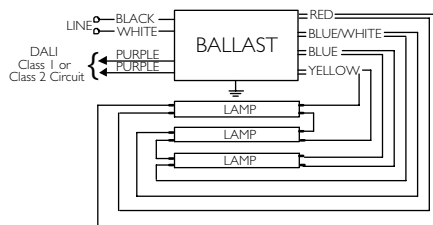

Diag. 57B

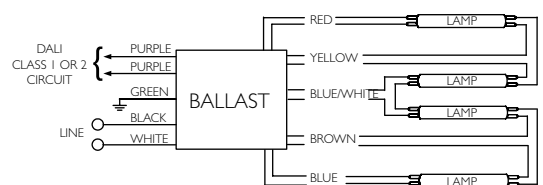

Diag. 167

ONLY USE RAPID-START SOCKETS

Refer to pages 3-14 to 3-19 for information on remote/tandem wiring and lead length extension.
 Refer to pages 4-23 for compatible ROVR controls.
 Refer to pages 9-24 to 9-28 for lead lengths and shipping data.

For 17 - 32W T8 Lamps

HIGH POWER FACTOR SOUND RATED A



ROVR Digital Addressable Ballasts

No. of Lamps	Input Volts	Lamp Starting Method	Ballast Family	Catalog Number	Max/Min		Full Light Output		Min. Starting Temp. (°F/°C)	Dim.	Wiring Dia.
					Input Power ANSI (Watts)	Ballast Factor	THD %	Line Current (Amps)			
F17T8, FBO16T8 (17W)											
1	120-277	PS	ROVR	IDA-132-SC	20/7	1.00/0.03	10	0.16-0.07	50/10	B	55B
2				IDA-2S32-SC	36/11			0.30-0.13			56B
F25T8, FBO24T8 (25W)											
1	120-277	PS	ROVR	IDA-132-SC	28/8	1.00/0.03	10	0.24-0.11	50/10	B	55B
2				IDA-2S32-SC	52/12			0.43-0.19			56B
3				IDA-3S32-G	79/19			0.65-0.28		G	57B
4				IDA-4S32	96/22	0.88/0.03		D		167	
F32T8, FBO31T8, F32T8/U6 (32W)											
1	120-277	PS	ROVR	IDA-132-SC	35/8	1.00/0.03	10	0.30-0.13	50/10	B	55B
2				IDA-2S32-SC	68/14			0.57-0.24			56B
3				IDA-3S32-G	99/20			0.87-0.37		G	57B
4				IDA-4S32	116/25	0.88/0.03		D		167	

Some lamp manufacturers recommend burning in new lamps 100 hours at full light output before dimming. Consult lamp manufacturer.
Ballasts utilizing poke-in connectors can accept wire gauges from AWG 16 - 20.

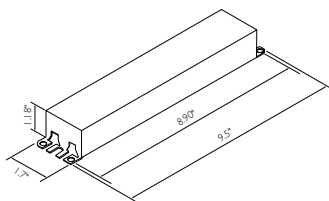

Fig. B

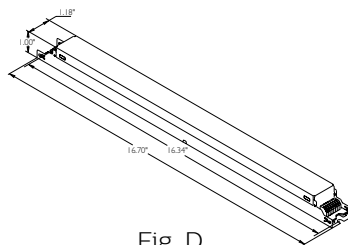

Fig. D

Includes connectors with no leads

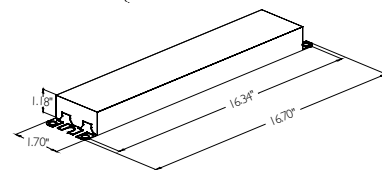

Fig. G

ONLY USE RAPID-START SOCKETS

Refer to pages 3-14 to 3-19 for information on remote/tandem wiring and lead length extension.

Refer to pages 4-21 for wiring diagrams.

Refer to pages 4-23 for compatible ROVR controls.

Refer to pages 9-24 to 9-28 for lead lengths and shipping data.

Control manufacturers who have products compatible with Philips Advance Mark 7 0-10V electronic dimming ballasts, Mark 10 *Powerline* electronic dimming ballasts and ROVR digital addressable ballasts. For more information, refer to the Control Compatibility Guide (Form No. EL-2100-AB-E) on our website.

Acuity Brands Controls	404-853-1400	www.acuitybrands.com
AMX Corporation	800-222-0193	www.amx.com
Anigmo	800-749-0518	www.anigmo.com
Automated Logic Corp.	740-429-3000	www.automatedlogic.com
AVAB America	877-797-7374	www.pwrseries.com
Centralite	877-463-5483	www.centralite.com
Colortran, a Leviton company	503-404-5500	www.colortran.com
Cooper Controls	800-553-3879	www.coopercontrol.com
Cooper Wiring Devices	866-853-4293	www.cooperwiringdevices.com
Crestron Electronics	888-CRESTON	www.crestron.com
Delta Controls	604-574-9444	www.deltacontrols.com
Digital Lighting Systems	305-969-8442	www.digitalighting.com
DimOnOff	418-682-3636	www.dimonoff.com
Douglas Lighting Controls	604-873-2797	www.douglaslightingcontrols.com
Eaton Corporation	803-481-6870	www.eaton.com
Electronic Theatre Controls	608-831-4116	www.etconnect.com
Entertainment Technology, a Philips company	800-223-9477	www.etdimming.com
Exergy Controls	562-981-2127	www.exergycontrols.com
H I Solutions	770-423-1150	www.hisolutions.net
Honeywell, Inc.	800-345-6770	www.honeywell.com
Hubbell Building Automation	888-698-3242	www.hubbell-automation.com
Hunt Dimming	970-484-9048	www.huntdimming.com
Intelligent Lighting Controls	800-922-8004	www.ilc-usa.com
Johnson Controls	414-274-4000	www.johnsoncontrols.com
Legrand	315-468-6211	www.passandseymour.com
Lehigh Electric Products Co.	610-395-3386	www.lehighdim.com
Leviton Lighting Controls Division	800-824-3005	www.leviton.com
Lighting Control and Design, an Acuity Brands Controls company	323-266-0000	www.lightingcontrols.com
Lightolier Controls, a Philips company	800-526-2731	www.lolcontrols.com
Lutron Electronics Co., Inc.	800-523-9466	www.lutron.com/advance
Marlin Controls	214-553-5700	www.marlincontrols.com
NexLight	218-828-3700	www.nexlight.com
Novar	216-682-1600	www.novar.com
Pass & Seymour, a Legrand company	315-468-6211	www.passandseymour.com
Payne Sparkman Mfg., Inc.	812-944-4893	www.paynesparkman.com
PDM Electrical Products, a Douglas Lighting Controls Subsidiary	514-342-6581	www.douglaslightingcontrol.com
Philips Lighting Systems & Controls	800-322-2086	www.philips.com/advance
PLC Multipoint	425-353-7552	www.plcmultipoint.com
Sensor Switch, an Acuity Brands Controls company	800-727-7483	www.sensorswitch.com
Starfield Controls, Inc.	303-926-4913	www.starfieldcorp.com
Sterner Controls	320-543-3595	www.sternercontrols.com
Strand Lighting Inc., a Philips company	714-230-8200	www.strandlighting.com
Synergy Lighting Control, an Acuity Brands Controls company	800-533-2719	www.synergylightingcontrols.com
Teletrol, a Philips company	603-645-6061	www.teletrol.com
Touch-Plate Lighting	219-424-4323	www.touchplate.com
TRIA TEK Lighting	770-242-1922	www.triateklighting.com
Vantage Lighting Control and Automation	801-229-2800	www.vantagecontrols.com
Vara-Light / Dimatronics / HUB	815-455-4400	
The WattStopper, a Legrand company	800-879-8585	www.wattstopper.com

The listed manufacturers have indicated that they manufacture products that are compatible with the Philips Advance Mark 7 0-10V electronic dimming ballasts, Philips Advance Mark 10 *Powerline* electronic dimming ballasts, or Philips Advance ROVR digital addressable ballasts. Philips Lighting North America Corporation provides this list as a convenience to our customers and control manufacturers. Philips Lighting North America Corporation does not support or recommend one manufacturer over another. Please refer to each manufacturer's catalog for a complete product description and performance specifications.



Electromagnetic Fluorescent Ballasts

General ballast information	5-1
Radio interference filter	5-2
Very high output ballasts for linear fluorescent lamps	5-3
Preheat ballasts for linear fluorescent lamps	5-4
Trigger start ballasts for linear fluorescent lamps.....	5-6
Ballasts for circline lamps	5-7
Ballasts for compact fluorescent lamps	5-8

Corporate Offices
(800) 322-2086

Customer Support/Technical Service
(800) 372-3331 • (+) 1 847 390-5000 (International)

Visit our web site at www.philips.com/oemna.

Supply Voltage and Frequency

Each ballast is designed to operate at the nominal voltage shown on the Philips Advance ballast label. Deviation from the applied voltage limits will result in damage to either the ballast or lamp or both. It is therefore necessary that the voltage applied to ballasts be maintained within the respective limits shown in the table below.

A ballast subjected to higher than nominal voltages will typically operate at increased temperatures. This will result in reduced ballast life. Low voltage can cause premature lamp failures as well as unreliable lamp starting.

All ballasts are designed for single frequency operation. Therefore, best results will be obtained when that ballast is used on the frequency shown on the ballast label. Frequency limitations are as follows:

Nominal	Frequency Limits
60HZ	57.5 to 62.5
50HZ	47.5 to 52.5

Prefix Code Letters	Normal Voltage	Applied Voltage Limits	Color Label Identification
H	120	112-127	Yellow
R	120	112-127	Yellow
L	120	112-127	Yellow
S	120	112-127	Yellow
X	220	210-230	Green
M	220/250	210-230 / 235-260	-
Y	240	225-250	Orange
V	277	255-290	Red
G	347	322-365	Gray

Safety

The National Electrical Code requires grounding of fluorescent fixtures. The fluorescent ballast case must be grounded either to the fluorescent fixture or, if remote mounted, by other means such as a wire from the ballast case to ground. Without proper fixture and ballast grounding, a shock hazard may exist due to the fluorescent fixture becoming energized by an internal ballast failure to case. Also, all ballasts have normal leakage current. When the ballast is properly grounded, the leakage current should not pose a problem.

Ballast Date Codes

Philips Advance electromagnetic fluorescent lamp ballasts are date stamped on the ballast cover to designate month and year of manufacture. The month is indicated first, followed by the year. In the example shown 0100, the manufacturing date is January 2000. In 2006 a new date stamp was implemented. The year is indicated first, followed by the calendar day of year and closes with an internal number (06 300 ###). For warranty information go to www.usa.lighting.philips.com/support/support/warranty.

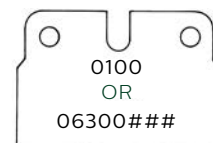

Indicates ballast is listed with Underwriters Laboratories, Inc. and complies with UL935 Standard for Fluorescent -Lamp Ballasts (File No. E14927).



U.L. RECOGNIZED

Indicates ballast is component recognized with UL and complies with UL935 Standard for Fluorescent Lamp Ballasts (File No. E14927).

Visit www.ul.com to find a current listing of Philips Advance ballasts under File No. E14927.



Indicates ballast is certified by Canadian Standards Association and complies with CSA-22.2 File No. 74 for Fluorescent-Lamp Ballasts (File No. 007310). Visit www.csa-international.org to find a current listing of Philips Advance ballasts under File No. 007310.



Philips Advance fluorescent ballasts are designed and manufactured in accordance with the American National Standards Institute standard for fluorescent ballasts, ANSI C82.1.



Indicates ballast complies with directive 2002/95/EC Restriction of Hazardous Substances.

Starting

The metal of a fluorescent fixture is a starting aid when properly grounded. T12 fluorescent lamps rated at 40W or less used for rapid or trigger start operation must be mounted within 1/2" of a grounded metal surface. T8 lamps must be mounted within 3/4" of a grounded metal surface. All other lamps must be mounted within 1" of a grounded metal surface.

An important additional factor for proper lamps starting is polarity. The white ballast lead must be connected to the ground of the power supply (neutral) and the black lead to the hot line wire. A reversal of polarity may result in lamp damage or improper lamp starting.

Ballast Sound

The slight hum present in fluorescent lighting installations originates from the inherent magnetic action in the core and coil assembly of the ballasts. This hum may be amplified by the method of mounting the ballast in the fixture – the fixture design – and, more often than not, this hum is amplified by the resonant qualities of the ceiling, walls, floors and furniture. In planning a lighting installation, careful consideration must be given to the selection of the fluorescent lamp ballast, the lighting fixture and room components. These precautions will help to achieve the quietest installation possible.

The choice of fluorescent lamp ballast should be made on the basis of selecting the one rated quietest for a specific location or interior as some ballasts have a more discernable hum due to basic construction features and electrical ratings.

Sound Ratings

For Any Installation in:	Average Ambient Noise Level Of Interior	Sound Level Rating*
TV or Radio Station, Library, Reception or Reading Room, Church, School Study Hall	20-24 Decibels	A
Residence, Quiet Office, Night School Classroom	25-30 Decibels	B
General Office Area, Commercial Building, Storeroom	31-36 Decibels	C
Manufacturing Facility, Retail Store, Noisy Office	37-42 Decibels	D

*These sound ratings are based on measurements of Average Ambient noise levels during conditions of normal occupancy. Audible ballast hum may appear amplified during exceptionally quiet periods and at times when area is unoccupied.

Radio Interference Filter



Radio interference is caused by the action of the arc at the lamp electrodes, which creates a series of radio waves. This energy may interfere with radio reception by:

1. Direct radiation from the fluorescent lamp to the aerial circuit.
2. Line feedback from the lamp through the power line to the radio.
3. Direct radiation from the electrical supply line to the aerial circuit.

To correct the first cause, it is recommended the radio and aerial circuit be separated at least 10 feet from the fluorescent lamp and the radio provided with a positive ground.

The second and third causes can generally be corrected by the addition of an external capacitor-reactor filter. It is also desirable that the radio and fluorescent lamp fixture be provided a supply voltage from separate branch circuits.

SOUND RATED A

Input Volts	Catalog Number	Certifications		Line Current (Amps)	Dimensions (inches)				Wiring Diagram
					Length	Width	Height	Mounting	
120-277	RIF-1	✓	✓	4.25 max.	4 ³ / ₄	2 ⁷ / ₃₂	1 ⁵ / ₈	4 ³ / ₈	118

For bottom leads with studs, add suffix -BLS.

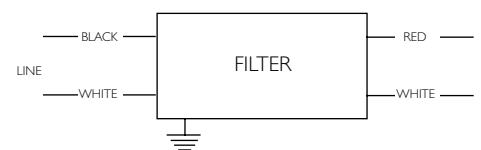

Diag. 118



T12/VHO Very High Output

HIGH POWER FACTOR SOUND RATED D

VHO & Powergroove Rapid Start Lamps

Lamp Data		Min. Starting Temp. (F)	Input Volts	Catalog Number	Certifications		Line Current (Amps)	Input Power ANSI (Watts)	Ballast Factor	THD %	Power Factor	Dim.	Wiring Dia.
Number	Watts				UL	SP							
F48T10/VHO (1500mA), F48T12/VHO (1500mA), F48PG17/VHO (1500mA)													
1	116	-20	120	RC-2S102-TP	✓	✓	1.70	130	0.87	<30	0.64	R-11	39
			277	VC-2S102-TP	✓	✓	0.59	137	0.85	<35	0.84		
2	116	-20	120	RC-2S102-TP	✓	✓	2.20	230	0.89	<35	0.87	R-11	21
			277	VC-2S102-TP	✓	✓	0.94	241	0.87	<35	0.93		
F60T10/VHO (1500mA), F60T12/VHO (1500mA)													
1	138	-20	120	RC-2S102-TP	✓	✓	1.75	140	0.90	<30	0.67	R-11	39
			277	VC-2S102-TP	✓	✓	0.65	157	0.86	<35	0.87		
2	138	-20	120	RC-2S200-TP	✓	✓	2.34	241	0.90	<20	0.86	R-11	21
F72T10/VHO (1500mA), F72T12/VHO (1500mA), F72PG17/VHO (1500mA)													
1	168	-20	120	RC-2S102-TP	✓	✓	1.90	173	0.87	<30	0.76	R-11	39
			277	VC-2S102-TP	✓	✓	0.69	168	0.87	<35	0.88		
2	168	-20	120	RC-2S200-TP	✓	✓	2.51	270	0.89	<20	0.90	R-11	21
			277	VS-2S200-TP	✓	✓	1.40	376	0.99	<15	0.97		
			120	RS-2S200-TP	✓	✓	2.90	314	0.85	<15	0.90		
F96T12/VHO Energy Saver (1580mA), F96PG17/VHO Energy Saver (1580mA)													
1	185	60	120	RC-2S102-TP	✓	✓	2.00	198	0.87	<35	0.83	R-11	39
			277	VC-2S102-TP	✓	✓	0.73	190	0.83	<35	0.94		
2	185	60	120	RC-2S200-TP	✓	✓	2.67	304	0.85	<15	0.95	R-11	21
			277	VS-2S200-TP	✓	✓	1.50	398	0.96	<15	0.96		
			120	RS-2S200-TP	✓	✓	2.95	320	0.80	<15	0.90		
F96T10/VHO (1500mA), F96T12/VHO (1500mA), F96PG17/VHO (1500mA)													
1	215	-20	120	RC-2S102-TP	✓	✓	2.10	213	0.87	<35	0.85	R-11	39
			277	VC-2S102-TP	✓	✓	0.89	216	0.88	<35	0.88		
			120	RC-2S200-TP	✓	✓	2.72	320	0.80	<15	0.98		
2	215	-20	120	RS-2S200-TP	✓	✓	3.31	358	0.85	<10	0.90	R-11	21
			277	VS-2S200-TP	✓	✓	1.65	442	0.90	<15	0.97		

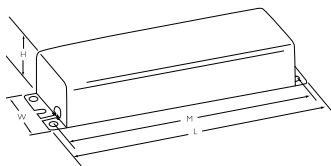

Case R

DIMENSIONS

Designation	Length (L) (inches)	Width (W) (inches)	Height (H) (inches)	Mounting (M) (inches)
R-11	14 ⁵ / ₁₆	3 ³ / ₁₆	2 ⁵ / ₈	13 ³ / ₄

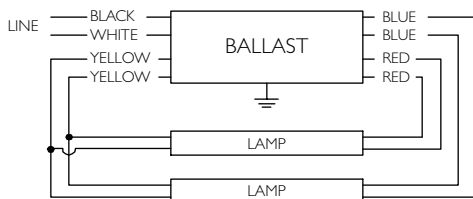

Diag. 21

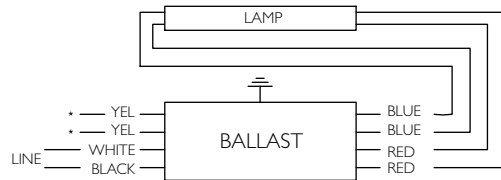

Diag. 39

Note: For a single lamp, insulate yellow leads individually for 600V

Refer to pages 9-24 to 9-28 for lead lengths and shipping data.

T5 & T8 Preheat Lamps

CLASS B INSULATION NORMAL POWER FACTOR SOUND RATED A



Preheat Ballasts (Starter Required)

Lamp Data		Min. Starting Temp. (F)	Input Volts	Catalog Number	Certifications		Line Current (Amps)	Input Power ANSI (Watts)	Ballast Factor	THD %	Power Factor	Dim.	Wiring Dia.
Number	Watts				UL	SF							
F4T5													
1	4	50	120	LPL-5-9 ✘	✓	✓	0.19	9	1.01	<10	0.39	X-1	116
				LC-4-9-C ★★	✓	✓	0.20	9	1.07	<10	0.38	C-2	116
F6T5													
1	6	50	120	LPL-5-9 ✘	✓	✓	0.17	9	1.02	<10	0.44	X-1	116
				LC-4-9-C ★★	✓	✓	0.19	10	1.07	<10	0.44	C-2	116
F8T5													
1	8	50	120	LPL-5-9 ✘	✓	✓	0.14	9	1.00	<10	0.54	X-1	116
				LC-4-9-C ★★	✓	✓	0.17	11	1.08	<10	0.54	C-2	116
F13T8													
1	13	50	120	LO-13-22 ✘	✓	✓	0.34	17	0.91	<10	0.42	X-3	116
F14T8													
1	14	50	120	LO-13-22 ✘	✓	✓	0.32	18	0.90	<20	0.47	X-3	116
				LC-14-20-C ★★	✓	✓	0.37	20	0.97	<10	0.45	C-2	116
F15T8													
1	15	50	120	LO-13-22 ✘	✓	✓	0.29	18	0.96	<10	0.52	X-3	116
				LC-14-20-C ★★	✓	✓	0.34	20	1.08	<10	0.49	C-2	116
F18T8													
1	18	50	120	LO-13-22 ✘	✓	✓	0.29	17	0.80	<15	0.49	X-3	116
				LC-14-20-C ★★	✓	✓	0.33	20	0.92	<10	0.51	C-2	116
F19T8													
1	19	50	120	LO-13-22 ✘	✓	✓	0.28	17	0.90	<15	0.51	X-3	116
				LC-14-20-C ★★	✓	✓	0.33	20	0.92	<15	0.51	C-2	116

- ✘ Available with Class P Thermal Protection— Add Suffix -TP to Catalog Number.
- ★ Core & Coil with Cover, painted white

DIMENSIONS

Designation	Length (L) (inches)	Width (W) (inches)		Height (H) (inches)	Mounting (M) (inches)
		Standard	With TP		
C-2	3 ¹ / ₁₆	1 ³ / ₈	1 ¹⁹ / ₃₂	1 ¹³ / ₁₆	2 ³ / ₄
X-1	2 ³ / ₈	1 ¹ / ₈	1 ³ / ₈	1 ³ / ₈	2
X-3	3 ¹ / ₁₆	1 ¹ / ₄	1 ⁷ / ₁₆	1 ¹³ / ₁₆	2 ³ / ₄

Refer to pages 5-5 for wiring and dimension diagrams.
Refer to pages 9-24 to 9-28 for lead lengths and shipping data.



T12 Preheat Lamps

CLASS B INSULATION NORMAL POWER FACTOR SOUND RATED A

Preheat Ballasts (Starter Required)

Lamp Data		Min. Starting Temp. (F)	Input Volts	Catalog Number	Certifications		Line Current (Amps)	Input Power ANSI (Watts)	Ballast Factor	THD %	Power Factor	Dim.	Wiring Dia.
Number	Watts				UL	SFA							
F14T12													
1	14	50	120	LO-13-22 ✖	✓	✓	0.34	18	0.92	<10	0.44	X-3	116
				LC-14-20-C ✖✖	✓	✓	0.39	21	1.01	<10	0.45	C-2	116
F15T12													
1	15	50	120	LO-13-22 ✖	✓	✓	0.32	18	0.97	<10	0.47	X-3	116
				LC-14-20-C ✖✖	✓	✓	0.38	21	1.10	<15	0.46	C-2	116
F20T12													
1	20	50	120	LO-13-22 ✖	✓	✓	0.28	18	0.77	<10	0.54	X-3	116
				LC-14-20-C ✖✖	✓	✓	0.33	21	0.93	<10	0.53	C-2	116
F25T12													
1	25	50	120	LC-25-TP ★	✓	✓	0.36	24	0.90	<10	0.56	C-2	116

✖ Available with Class P Thermal Protection--
 Add Suffix -TP to Catalog Number.

★ Core & Coil with Cover, painted white

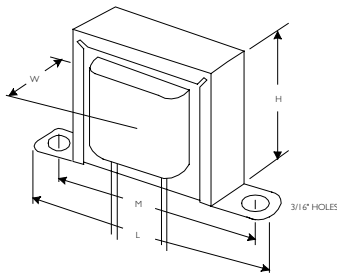

Case X-1

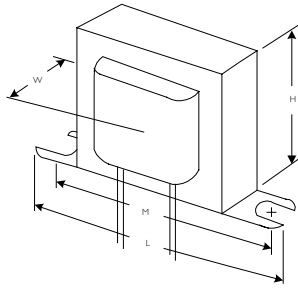

Case X-3,
X-5, X-8

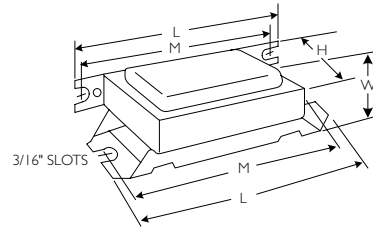

Case C

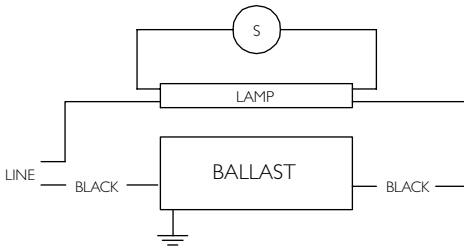

Diag. 116

Refer to pages 5-4 for dimensions.
 Refer to pages 9-24 to 9-28 for lead lengths and shipping data.

T8 & T12 Preheat Lamps

HIGH POWER FACTOR SOUND RATED A



Trigger Start Ballasts

Lamp Data		Min. Starting Temp. (F)	Input Volts	Catalog Number	Certifications		Line Current (Amps)	Input Power ANSI (Watts)	Ballast Factor	THD %	Power Factor	Dim.	Wiring Dia.
Number	Watts				UL	SF							
F13T8													
1	13	20	120	RLQ-120-TP ❖❖	✓	✓	0.54	23	1.00	<10	0.35	R-4	16
2	13	30	120	RL-2SP20-TP*	✓	✓	0.58	36	1.00	<10	0.52	T-1	21
F15T8													
1	15	50	120	RLQ-120-TP ❖❖	✓	✓	0.56	28	1.01	<10	0.42	R-4	16
		0		HM-1P20-TP	✓	✓	0.24	27	0.90	<15	0.94	T-2	20
2	15	50	120	RL-2SP20-TP*	✓	✓	0.51	36	0.78	<15	0.59	T-1	21
		20		HM-2SP20-TP	✓	✓	0.47	51	0.99	<20	0.90	T-2	21
F14T12													
1	14	50	120	RLQ-120-TP ❖❖	✓	✓	0.58	28	0.92	<10	0.40	R-4	16
		0		HM-1P20-TP	✓	✓	0.21	24	0.82	<10	0.95	T-2	20
2	14	0	120	HM-2SP20-TP	✓	✓	0.43	46	0.85	<10	0.90	T-2	21
F15T12													
1	15	50	120	RLQ-120-TP ❖❖	✓	✓	0.58	29	0.99	<10	0.42	R-4	16
		0		HM-1P20-TP	✓	✓	0.23	27	0.89	<15	0.98	T-2	20
2	15	50	120	RL-2SP20-TP *	✓	✓	0.57	41	0.83	<10	0.60	T-1	21
		10		HM-2SP20-TP	✓	✓	0.44	47	0.92	<15	0.90	T-2	21
F20T12													
1	20	50	120	RLQ-120-TP ❖❖	✓	✓	0.55	28	0.83	<10	0.42	R-4	16
		0		HM-1P20-TP	✓	✓	0.24	29	0.83	<20	0.99	T-2	20
2	20	50	120	RL-2SP20-TP *	✓	✓	0.49	36	0.61	<15	0.61	T-1	21
		10		HM-2SP20-TP	✓	✓	0.48	53	0.90	<20	0.92	T-2	21

- ❖ Requires Circuit-Interrupting Lamp Holders
- * Normal Power Factor
- + Mounting dimensions refer to slots only

DIMENSIONS

Designation	Length (L) (inches)	Width (W) (inches)	Height (H) (inches)	Mounting (M) (inches)
R-4	6½	1 ¹⁵ / ₁₆	1 ³ / ₈	6+
T-1	6½	2 ³ / ₈	1½	6+
T-2	9½	2 ³ / ₈	6½	8 ²⁹ / ₃₂

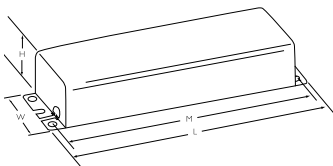

Case R

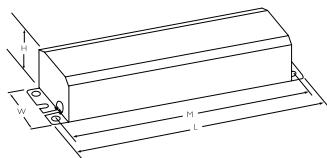

Case T

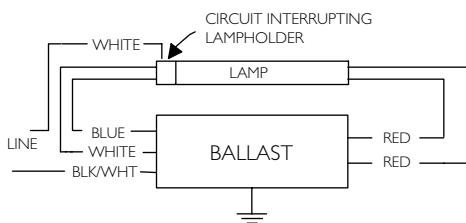

Diag. 16

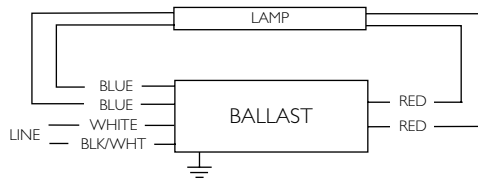

Diag. 20

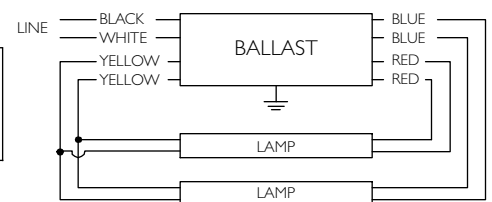

Diag. 21

Refer to pages 9-24 to 9-28 for lead lengths and shipping data.



T9 Circline Lamps

NORMAL POWER FACTOR SOUND RATED A

Rapid Start Ballasts

Lamp Data		Min. Starting Temp. (F)	Input Volts	Catalog Number	Certifications		Line Current (Amps)	Input Power ANSI (Watts)	Ballast Factor	THD %	Power Factor	Dim.	Wiring Dia.
Number	Watts				UL	SF							
FC6T9 (20W Circline)													
1	20	50	120	RLQS-122-TP-W	✓	✓	0.56	24	0.76	<10	0.36	R-4	32
FC8T9 (22W Circline)													
1	22	50	120	RLQS-122-TP-W	✓	✓	0.53	25	0.75	<10	0.39	R-4	32
FC12T9 (32W Circline)													
1	32	50	120	RLCS-140-TP-W	✓	✓	0.57	31	0.63	<10	0.45	R-4	32
FC16T9 (40W Circline)													
1	40	50	120	RLCS-140-TP-W	✓	✓	0.44	28	0.50	<15	0.53	R-4	32
(1)FC8T9 and (1)FC12T9 ((1)22W & (1)32W Circline)													
2	22 & 32	50	120	RS-22-32-TP-W	✓	✓	0.40	46	0.70	<15	0.96	T-1	105
(1)FC12T9 and (1)FC16T9 ((1)32W & (1)40W Circline)													
2	32 & 40	50	120	RS-32-40-TP-W	✓	✓	0.76	56	0.60	<20	0.61	T-1	105

+ Mounting dimensions refer to slots only

Note: All Ballasts supplied with Circline sockets in white can except RL-140-TP.

DIMENSIONS

Designation	Length (L) (inches)	Width (W) (inches)	Height (H) (inches)	Mounting (M) (inches)
R-4	6½	1 ¹⁵ / ₁₆	1 ³ / ₈	6+
T-1	6½	2 ³ / ₈	1½	6+

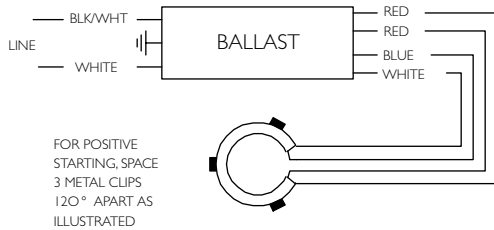
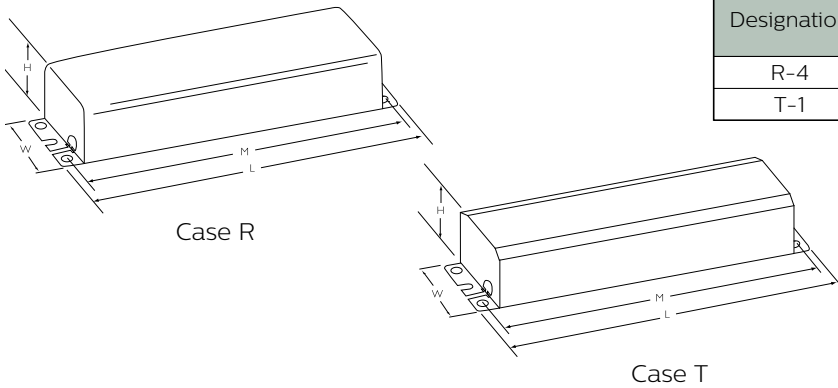

Diag. 32

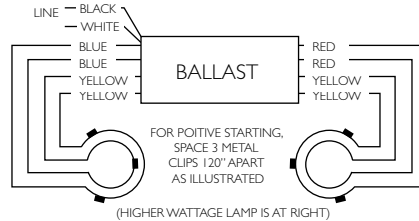

Diag. 105

Refer to pages 9-24 to 9-28 for lead lengths and shipping data

T4 2-Pin Compact & T5 4-Pin Long Twin Tube Lamps



CLASS B INSULATION NORMAL POWER FACTOR SOUND RATED A

Preheat Ballasts

Lamp Data		Min. Starting Temp. (F)	Input Volts	Catalog Number	Certifications		Line Current (Amps)			Input Power ANSI (Watts)	Ballast Factor	THD %	Dim.	Wiring Dia.
Number	Watts				UL	SF	Operating	Starting	Open Circuit					
CFT5W/G23 - 5W Twin Tube Lamp (PL-S5W, F5BX, CF5DS)														
1	5	0	120	LPL-5-9-TP	✓	✓	0.19	0.19	-	9	1.06	<10	X-1	140
CFT7W/G23 - 7W Twin Tube Lamp (PL-S7W, F7BX, CF7DS)														
1	7	0	120	LPL-5-9-TP	✓	✓	0.17	0.19	-	9	0.96	<10	X-1	140
CFT9W/G23 - 9W Twin Tube Lamp (PL-S9W, F9BX, CF9DS) CFQ9W/G23 - 9W Quad Tube Lamp (F9DBX23T4, CF9DD)														
1	9	25	120	LPL-5-9-TP	✓	✓	0.14	0.19	-	10	0.89	<10	X-1	140
CFT13W/GX23 - 13W Twin Tube Lamp (PL-S13W, F13BX, CF13DS) CFQ13W/GX23 - 13W Quad Tube Lamp (PL-C13W/USA, F13DBX23T4, CF13DD)														
1	13	32	120	LC-13-TP ★	✓	✓	0.27	0.37	-	16	0.93	<15	C-2	140
				LO-13-22-TP	✓	✓	0.29	0.44	-	17	1.00	<15	X-3	140
2	13	32	277	VLO-13-TP	✓	✓	0.30	0.35	-	22	1.00	<10	X-5	140
			277	VLO-2S13-TP	✓		0.31	0.38	-	34	0.95	<15	X-8	46
FT18W/2G11 - 18W Long Twin Tube Lamp (PL-L18, F18BX, FT18DL) - Separate Starter Required														
1	18	50	120	LC-25-TP ★	✓	✓	0.39	0.59	-	22	1.05	<15	C-2	44
				LO-13-22-TP	✓	✓	0.21	0.44	-	16	0.89	<20	X-3	44
CFQ26W/G24d - 26W Quad Tube Lamp (PL-C26W, F26DBXT4, CF26DD)														
1	26	50	277	VLO-13-TP	✓	✓	0.27	0.35	-	29	0.80	<10	X-5	140
CFQ27W/GX32d - 28W Quad Tube Lamp (PL-C 15mm/28W, FDL-28)														
1	28	-20	120	LOS-1Q28 f	✓	✓	0.61	0.74	-	32	0.97	<15	X-6	107

★ Core & Coil with Cover, painted white
f For Outdoor Use Only

DIMENSIONS

Designation	Length (L) (inches)	Width (W) (inches)		Height (H) (inches)	Mounting (M) (inches)
		Standard	With TP		
C-2	3 ¹ / ₁₆	1 ³ / ₈	1 ⁹ / ₃₂	1 ¹³ / ₁₆	2 ³ / ₄
X-1	2 ³ / ₈	1 ¹ / ₈	1 ³ / ₈	1 ³ / ₈	2
X-3	3 ¹ / ₁₆	1 ¹ / ₄	1 ⁷ / ₁₆	1 ¹³ / ₁₆	2 ³ / ₄
X-5	3 ³ / ₄	1 ¹ / ₂	1 ³ / ₄	2	2 ³ / ₁₆
X-6	3 ¹ / ₁₆	1 ¹ / ₂	-	1 ¹³ / ₁₆	2 ³ / ₄
X-8	4	1 ⁹ / ₁₆	1 ¹³ / ₁₆	2 ¹ / ₄	3 ¹ / ₂

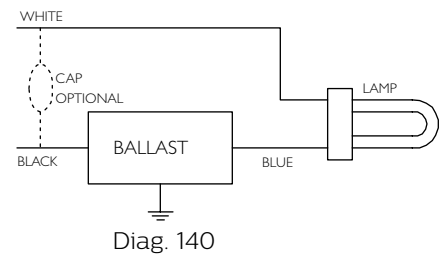
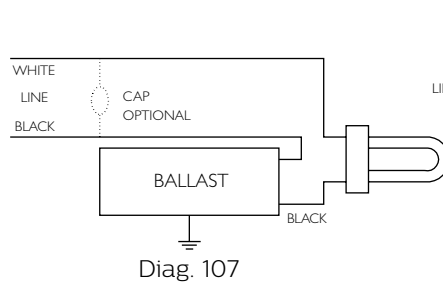
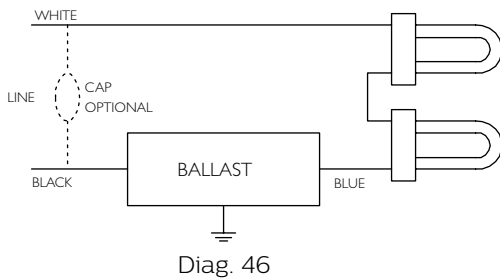
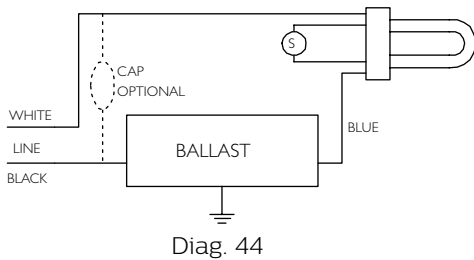

Refer to page 5-5 for dimension diagrams.
Refer to pages 9-24 to 9-28 for lead lengths and shipping data.



T4 2-Pin Compact Lamps

HIGH POWER FACTOR SOUND RATED A

Preheat Ballasts

Lamp Data		Min. Starting Temp. (F)	Input Volts	Catalog Number	Certifications		Line Current (Amps)			Input Power ANSI (Watts)	Ballast Factor	THD %	Dim.	Wiring Dia.
Number	Watts				UL	SF	Operating	Starting	Open Circuit					
CFT5W/G23 - 5W Twin Tube Lamp (PL-S5W, F5BX, CF5DS)														
1	5	25	120	H-1B9-TP-W	✓	✓	0.10	0.20	0.13	11	1.06	<20	R-1	47
		0	277	VH-1B9-TP-W	✓	✓	0.05	0.18	0.17	11	0.95	<35	R-2	47
CFT7W/G23 - 7W Twin Tube Lamp (PL-S7W, F7BX, CF7DS)														
1	7	0	120	H-1B9-TP-W	✓	✓	0.10	0.20	0.13	11	1.00	<20	R-1	47
			277	VH-1B9-TP-W	✓	✓	0.05	0.18	0.17	12	0.93	<30	R-2	47
CFT9W/G23 - 9W Twin Tube Lamp (PL-S9W, F9BX, CF9DS) CFQ9W/G23 - 9W Quad Tube Lamp (F9DBX23T4, CF9DD)														
1	9	25	120	H-1B9-TP-W	✓	✓	0.10	0.20	0.13	11	0.92	<20	R-1	47
		0	277	VH-1B9-TP-W	✓	✓	0.05	0.18	0.17	13	0.95	<35	R-2	47
CFT13W/GX23 - 13W Twin Tube Lamp (PL-S13W, F13BX, CF13DS) CFQ13W/GX23 - 13W Quad Tube Lamp (PL-C13W/USA, F13DBX23T4, CF13DD)														
1	13	32	120	H-1B13-TP-W	✓	✓	0.14	0.36	0.22	16	0.90	<25	R-1	47
		0	277	VH-1B13-TP-W	✓	✓	0.10	0.30	0.26	24	0.99	<30	R-2	47
2	13	32	120	H-2B13-TP-BLS	✓	✓	0.30	0.44	-	35	1.02	<30	T-1	51
		0	277	VH-2B13-TP-BLS	✓	✓	0.10	0.35	0.21	27	0.92	<30	R-2	50
CFQ26W/G24d - 26W Quad Tube Lamp (PL-C26W, F26DBXT4, CF26DD) CFTR26W/GX24d - 26W Triple Tube Lamp (CF26DT)														
1	26	50	120	H-1Q26-TP-W	✓	✓	0.24	0.33	0.41	28	0.83	<20	T-1	47
			277	VH-1Q26-TP-W	✓	✓	0.11	0.38	0.24	32	0.90	<20	R-2	47
2	26	50	120	H-2Q26-TP-BLS	✓	✓	0.42	0.34	-	50	0.82	<15	R-5	50
			277	VH-2Q26-TP-BLS	✓	✓	0.21	0.32	-	58	0.87	<25	R-5	51

+ Mounting dimensions refer to slots only

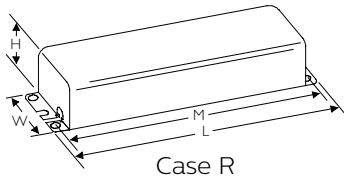

Case R

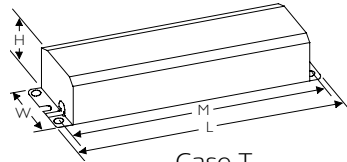

Case T

DIMENSIONS

Designation	Length (L) (inches)	Width (W) (inches)	Height (H) (inches)	Mounting (M) (inches)
R-1	4¼	2	1 ⁷ / ₁₆	3 ⁹ / ₁₆
R-2	4¾	2 ⁷ / ₃₂	1 ⁵ / ₈	4 ³ / ₈ +
R-5	9½	2 ³ / ₈	1 ¹¹ / ₁₆	8 ²⁹ / ₃₂
T-1	6½	2 ³ / ₈	1½	6+

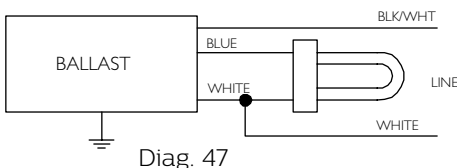

Diag. 47

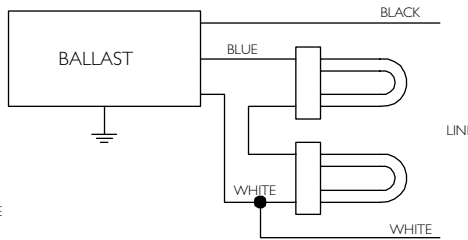

Diag. 50

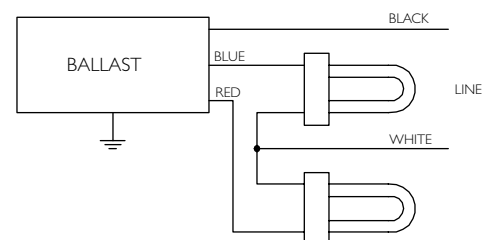

Diag. 51

Refer to pages 9-24 to 9-28 for lead lengths and shipping data.



Electronic HID Ballasts

General ballast information	6-1
e-Vision	6-3
CosmoPolis	6-6
MasterColor CDM Elite medium wattage	6-8
Wiring diagrams and dimensions	6-9

Corporate Offices
(800) 322-2086

Customer Support/Technical Service
(800) 372-3331 • (+) 1 847 390-5000 (International)

Visit our web site at www.philips.com/oemna.

Note: Refer to page 9-21 to 9-23 for Ballast Specifications.

Electronic HID Overview

Just as electronic ballast technology enhanced fluorescent lighting systems, electronic HID ballasts bring significant performance improvements to HID lighting systems, including:

- Higher efficiency
- Greater lumen maintenance
- Longer lamp life
- Enhanced color control

e-Vision

Low frequency electronic ballasts are recommended by lamp manufacturers to drive the latest generation of ceramic, low wattage metal halide lamps. These ceramic lamps have superior color rendition and can potentially maintain that color over the life of the lamps when properly operated with electronic ballasts. Since color is dependent on proper lamp wattage, the electronic ballast must be able to maintain lamp wattage precisely at its rated point throughout the rated average life of the lamp. Low frequency electronic HID ballasts, such as the Philips Advance e-Vision line, constantly measure and adjust the wattage, optimizing delivery of the ceramic lamps' superior color properties. This makes ceramic metal halide operated by e-Vision ballasts the premier choice for many applications previously illuminated by either tungsten halogen or incandescent sources, such as retail lighting.

Operational improvements are gained as greater efficiency and cooler running electronic ballasts lead to energy savings. In addition, ballasts run quieter, weigh less and have smaller footprints.

CosmoPolis

CosmoPolis presents a major step forward in outdoor lighting and was developed specifically to meet the challenges of the 21st century. The CosmoPolis system simplifies outdoor lighting with the combination of a compact lamp and an optimized, rugged electronic ballast system. Designed specifically for outdoor area and roadway lighting applications, these Xtreme ballasts have integral surge protection of 10kV/5kA, and 80,000 hours rated average life.* This highly efficient system provides end users the ability to convert to a warm white light without sacrificing color rendering or system lifetime.

MasterColor Elite Medium Wattage

The lamp's sparkling white light with 90 CRI creates a natural ambiance and brings out the best in all different types of colors. The high efficiency of the lamp and ballast together means reduced energy use and a lower cost of ownership compared to traditional 400W Metal Halide HID systems.** The e-Vision ballast comes with 0-10V control wires that allow for dimming to 50% of lamp power and allow for operation by 0-10V controls such as the Philips DynaDimmer. This system is ideal for indoor lighting in both high-bay and recessed applications, as well as outdoor lighting for street and area installations.

* Rated average life is based on 90% surviving when operating at 10°C less than the marked maximum case temperature (Tc - 10°C) with one switch per day. Rated average life is based on engineering testing in laboratory conditions and probability data as defined in IEC Norm 60929.

** Based on a comparison of published data of a Philips CDM EliteMW 315/T9/942/U/E lamp operated by Philips Advance IZTMH-210315-R-LF (341 System Watts) to a Philips MS400/BU/ED28/PS operated by a Philips Advance 71A6092AEE ballast (452 system Watts) operated for 30,000 hours (rated average life of 315W CDM Elite lamp).

Catalog Number Explanation

I	ZT	MH	_	100	A	BLS	ID	Additional Features: Blank = None ID = Integral 120V output to supply power to a 4-Wire Self Heating Thermal Protector (39W, 70W, 100W)
<p>Lead Exit / Mounting Options: BLS = Bottom Leads with Studs LF = Leads (side exit) with mounting Feet LFS = Leads (side exit, lead exit from same end) with mounting Feet (K metal case models only) LS = Connector (side exit) with mounting Feet</p> <p>Can Material / Size: (Dimensions include mounting feet) A/B = Metal case with dim. 5.5" L x 3.6" W x 1.5" H K = Metal case with dim. 4.75" L x 1.3" W x 1.2" H D = Metal case with dim. 5.0" L x 3.0" W x 1.5" H M = Plastic case with dim. 5.9" L x 2.6" W x 2.6" H (no longer available) E = Metal case with dim. 5.5" L x 1.75" W x 1.2" H N = Plastic case with dim. 5.3" L x 2.6" W x 2.6" H (no longer available) G = Metal case with dim. 3.9" L x 3.0" W x 1.2" H Q = Plastic case with dim. 5.9" L x 3.5" W x 1.5" H H = Metal case with dim. 6.4" L x 3.7" W x 1.5" H R = Metal case with dim. 8.2" L x 4.9" W x 2.2" H T = Plastic case with dim. 6.3" L x 3.9" W x 2.4" H (no longer available)</p> <p>Max Lamp Wattage: G20 = 20W Lamp, ANSI C156/M156 P39 = 39W Lamp+ 60 = 60W Lamp 100 = 100W Lamp 210315 = 210 W or 315W Lamp 20 = 22 W Lamp^ 45 = 45W Lamp 70 = 70W Lamp 140 = 140W Lamp 39 = 39 W Lamp, ANSI C130/M130 50 = 50W Lamp 90 = 90W Lamp 150 = 150W Lamp</p> <p>Number of Lamps: Blank = 1 Lamp Operation 2 = 2 Lamp Operation</p> <p>Primary Lamp Type: MH = Metal Halide CW = CosmoPolis Metal Halide</p> <p>Dimming Scheme: Blank = Fixed Light Output ZT = 0-10V Dimming D = Programmable DALI Interface (no longer available)</p>								
<p>Input Voltage: I = Intellivolt (accepts input of 120 thru 277V, 50/60 Hz nominal)[‡] R = 120V, 50/60 Hz nominal</p>								

[^] Philips 22W MiniMaster Color Lamp, ANSI C175/M175, with PGj5 base

⁺ Philips 39W MiniMaster Color Lamp, ANSI C179/M179, with PGj5 base

[‡] For CosmoPolis and MasterColor CDM Elite Medium Wattage, Intellivolt is limited to 208 thru 277V

e-Vision Low Frequency Electronic HID Ballasts

For Low Wattage HID Lamps

Key Features	Key Benefits
IntelliVolt • Operates on either 120 or 277V, or any voltage in between, 50 or 60Hz	• Fewer SKUs required in inventory • Broadens the range of applications
Smaller and lighter weight than magnetic HID F-Can ballasts	• Compact footprints • Provides greater design flexibility
Reduced input watts compared to magnetic systems	• Energy savings; lower cost of ownership
Low frequency lamp operation	• Prevents acoustic resonance in the lamp arc tube
Square wave output waveform	• Helps maximize lamp life
Lamp EOL detection; shuts down system at lamp end of life	• Enhanced safeguard
Thermally protected, internally fused and output short circuit protected	• Shuts system down upon abnormal failure or conditions
Lamp wattage regulation • Lamp wattage will change less than .5% with a +/-10% change in line voltage	Excellent light quality • Optimizes lamp color stability over time • Reduces lamp-to-lamp color variations both initially and during lamp life
Metallic enclosure	• Provides enhanced capability for high ambient temperatures by transferring heat away from sensitive internal components
1.0 Ballast Factor	• Lamp produces maximum light output over its rated average life

eHID Lead Wire Information

Wire Color	Function	Lengths Lead (-LF model)	Lengths (-BLS model)	Length Strip
Black	Input Power	11.0" +/- 1.0"	9.0" +3.0"/-2.0"	0.5"
White	Input Power	11.0" +/- 1.0"	9.0" +3.0"/-2.0"	0.5"
Red	Lamp Base	11.0" +/- 1.0"	9.0" +3.0"/-2.0"	0.5"
Blue	Lamp Screwshell	11.0" +/- 1.0"	9.0" +3.0"/-2.0"	0.5"
Green	Ground	11.0" +/- 1.0"	9.0" +3.0"/-2.0"	0.5"
Orange	Lamp Base (Second Lamp on 2-Lamp Ballasts)	11.0" +/- 1.0"	9.0" +3.0"/-2.0"	0.5"
Brown	Lamp Screwshell (Second Lamp on 2-Lamp Ballasts)	11.0" +/- 1.0"	9.0" +3.0"/-2.0"	0.5"
Yellow	Output for 120V Self Heating Thermal protector	N/A	9.0" +3.0"/-2.0"	0.5"
Gray with Red Stripe	Output for 120V Self Heating Thermal protector	N/A	9.0" +3.0"/-2.0"	0.5"

Metal Halide



Lamp Data		Input Volts	Catalog Number* <i>Note 1</i>	Certifications		Line Current (Amps)	Input Power ANSI (Watts)	Max. Case Temp. <i>Note 3</i>	Wiring Diag.	Fig.	Weight (lb)	Max. Distance to Lamp (ft)
Number	Watts											
20W Lamp, ANSI Code M156/C156 Minimum Starting Temp. -20°C/-4°F												
1	20	120	IMH-G20-K-LF, IMH-G20-K-LFS or IMH-G20-K-BLS <i>Note 2</i>	✓	✓	0.2	24	90°C	3	K	0.5	4
		277				0.10						
1	20	120	IMH-G20-G-LF IMH-G20-G-BLS	✓	✓	0.2	24	90°C	3	G	0.9	5
		277				0.09						
1	20	120	IMH-G20-E-LF	✓	✓	0.21	24	90°C	3	E	0.8	5
		277				0.09						
22W Lamp, Philips Mini MasterColor, ANSI Code M175/C175, Minimum Starting Temp. -20°C/-4°F												
1	22	120	RMH-20-K-LF, RMH-20-K-LFS or RMH-20-K-BLS <i>Note 2</i>	✓	✓	0.23	26	90°C	4	K	0.5	6
39W Lamp, ANSI Code M130/C130, Minimum Starting Temp. -20°C/-4°F												
1	39	120	IMH-39-K-LF, IMH-39-K-BLS or IMH-39-K-LFS <i>Note 2</i>	✓	✓	0.39	46	90°C	3	K	0.5	4
		277				0.18	45					
1	39	120	IMH-39-G-LF or IMH-39-G-BLS	✓	✓	0.37	44	90°C	3	G	0.9	3
		277		✓	✓	0.17	43					
1	39	120	IMH-39-E-LF	✓	✓	0.38	44	90°C	3	E	0.8	5
		277		✓	✓	0.16	43					
1	39	120	IMH-39-A-BLS-ID ^x	✓	✓	0.45	48	90°C	8	A	1.5	5
		277		✓	✓	0.18	47					
2	39	120	IMH-239-A-LF or IMH-239-A-BLS	✓	✓	0.74	89	85°C	5	A	1.7	6
		277		✓	✓	0.31	86					
39W Mini MasterColor Lamp, CDM-Tm 35W/930, ANSI Code M179/C179 Minimum Starting Temp. -20°C/-4°F												
1	39	120	IMH-P39-G-LF IMH-P39-G-BLS	✓	✓	0.39	46	90°C	3	G	0.9	5
		277		✓	✓	0.17	45					
1	39	120	RMH-39-K-LF, RMH-39-K-BLS or RMH-39-K-LFS <i>Note 2</i>	✓	✓	0.40	45	90°C	4	K	0.5	6

1. All ballasts are sound rated A and feature high power factor (>0.9), a ballast factor of 1.0 resettable thermal protection and a maximum Harmonic Distortion of 15%.
2. For IMH-39-K-LF, RMH-39-K-LF, RMH-20-K-LF and IMH-G20-K-LF input and output lead wires exit on opposite sides of ballast. For IMH-39-K-LFS, RMH-39-K-LFS, RMH-20-K-LFS and IMH-G20-K-LFS all lead wires exit the same side of the ballast.
3. Maximum case temperature should not be exceeded in the application, as life will be affected and the integral resettable thermal protector may activate. A lower maximum temperature rating does not imply lesser thermal performance and can be indicative of a cooler running ballast design. Consult factory for further application assistance.

* Ordering information:

- LF Side exit leads with mounting feet
- BLS Bottom exit leads with mounting studs

^x Use with any Self Heating Thermal Protector (Insulation Detector) having equivalent resistive value 5k to 25k ohm (4 wire versions only).

^Y Restrictions on Hazardous Substances (RoHS) is a European directive (2002/95/EC) designed to limit the content of 6 substances [lead, mercury, cadmium, hexavalent chromium, polybrominated biphenyls (PBB) and polybrominated diphenyl ethers (PBDE)] in electrical and electronic products.

Refer to page 6-3 for lead wire information.
 Refer to pages 6-10 to 6-11 for ballast dimensions.
 Refer to page 6-9 for wiring diagrams.

Metal Halide



Lamp Data		Input Volts	Catalog Number* <i>Note 1</i>	Certifications			Line Current (Amps)	Input Power ANSI (Watts)	Max. Case Temp. <i>Note 3</i>	Wiring Diag.	Fig.	Weight (lb)	Max. Distance to Lamp (ft)
Number	Watts			E	UL	SF							
50W Lamp, ANSI Code M110, or C193(Philips CDM Elite), Minimum Starting Temp. -20°C/-4°F													
1	50	120	IMH-50-E-LF	✓	✓	0.48	57	90°C	3	E	0.8	5	
		277				0.20	56						
1	50	120	IMH-50-K-LF, IMH-50-K-BLS or IMH-50-K-LFS <i>Note 2</i>	✓	✓	0.48	57	90°C	3	K	0.5	4	
		277				0.21	56						
1	50	120	IMH-50-G-LF or IMH-50-G-BLS	✓	✓	0.47	56	90°C	3	G	0.9	3	
		277				0.21	55						
70W Lamp, ANSI Code M98/C98 or M139/C139 or M143, Minimum Starting Temp. -20°C/-4°F													
1	70	120	IMH-70-G-LF or IMH-70-G-BLS	✓	✓	0.66	79	90°C	3	G	0.9	3	
		277				0.28	76						
1	70	120	IMH-70-E-LF	✓	✓	0.68	80	90°C	3	E	0.8	5	
		277				0.29	78						
1	70	120	IMH-70-D-LF or IMH-70-D-BLS	✓	✓	0.66	79	85°C	3	D	1.6	3	
		277				0.28	76						
1	70	120	IMH-70-A-BLS-ID ^x	✓	✓	0.72	86	90°C	8	A	1.6	6	
		277				0.31	84						
100W Lamp, ANSI Code M90/C90 or M140 or C191, Minimum Starting Temp. -20°C/-4°F													
1	100	120	IMH-100-D-LF or IMH-100-D-BLS	✓	✓	0.92	110	85°C	3	D	1.6	5	
		277				0.40	109						
1	100	120	IMH-100-B-LF	✓	✓	0.92	110	85°C	3	B	1.5	5	
		277				0.40	109						
1	100	120	IMH-100-A-BLS-ID ^x	✓	✓	0.96	115	90°C	8	A	1.4	6	
		277				0.42	113						
150W Lamp, ANSI Code M102/C102 or M142/C142, Minimum Starting Temp. -20°C/-4°F													
1	150	120	IMH-150-H-LF or IMH-150-H-BLS <i>Note 4</i>	✓	✓	✓	1.4	165	85°C	3	H	1.9	5
		277					0.6	161					

- All ballasts are sound rated A and feature high power factor (>0.9), a ballast factor of 1.0 resettable thermal protection and a maximum Harmonic Distortion of 15%.
- For IMH-39-K-LF, RMH-39-K-LF, RMH-20-K-LF and IMH-G20-KLF input and output lead wires exit on opposite sides of ballast. For IMH-39-K-LFS, RMH-39-K-LFS, RMH-20-K-LFS and IMH-G20-K-LFS all lead wires exit the same side of the ballast.
- Maximum case temperature should not be exceeded in the application, as life will be affected and the integral resettable thermal protector may activate. A lower maximum temperature rating does not imply lesser thermal performance and can be indicative of a cooler running ballast design. Consult factory for further application assistance.

- * Ordering information:
 — LF Side exit leads with mounting feet
 — BLS Bottom exit leads with mounting studs

^x Use with any Self Heating Thermal Protector (Insulation Detector) having equivalent resistive value 5k to 25k ohm (4 wire versions only).

∇ Restrictions on Hazardous Substances (RoHS) is a European directive (2002/95/EC) designed to limit the content of 6 substances [lead, mercury, cadmium, hexavalent chromium, polybrominated biphenyls (PBB) and polybrominated diphenyl ethers (PBDE)] in electrical and electronic products.

Refer to page 6-3 for lead wire information.
 Refer to pages 6-10 to 6-11 for ballast dimensions.
 Refer to page 6-9 for wiring diagrams.

Fixed Output CosmoPolis Xtreme

With CosmoPolis, Philips presents a major step forward in urban outdoor lighting, developed specifically to meet the challenges you face in the 21st century. The CosmoPolis system simplifies outdoor lighting with the combination of a miniature lamp and an optimized electronic ballast system.

All CosmoPolis ballasts come standard with our Xtreme features of 80,000 hr lifetime¹ and integral 10kV/5kA surge protection.

Six Performance Features of the CosmoPolis System

1. Quality of Light
2. System Efficiency
3. Optical Efficiency
4. Dependable Service
5. Compact System
6. Sustainability RoHS Compliant

With CosmoPolis, the benefits you experience from using Philips outdoor HID lamps are more impressive than ever.

CosmoPolis is not a retrofit for existing lamps, but offers you impressive benefits for new or renewed installations.

Consider:

- CosmoWhite 45W instead of HPS 50W, QMH 70W.
- CosmoWhite 60W instead of HPS 70W, MV/QMH 100W.
- CosmoWhite 90W instead of HPS 100W, MV/QMH 175W.
- CosmoWhite 140W instead of HPS 150W, MV/QMH 250W.

Applications

- Outdoor: Architectural façade lighting, illumination of roads and pedestrian areas, public spaces and parking garages



¹ Lifetime is specified as 80,000 Hours with 10% failures at Tcase at 80°C.

CosmoPolis Xtreme



Lamp Data		Input Volts	Catalog Number	Certifications		Line Current (Amps)	Input Power ANSI (Watts)	Max. Case Temp.	Wiring Diag.	Fig.	Weight (lb)	Max. Distance to Lamp (ft)	System Lumens/Watt ²
Number	Watts												
45W CosmoWhite Lamp, ANSI Code C196 Minimum Starting Temp -30°C/-22°F													
1	45	208	ICW-45-Q-LS ¹	✓	✓	0.25	51	90°C	10	Q	1.8	30	93
		277				0.18	51						
60W CosmoWhite Lamp, ANSI Code C187 Minimum Starting Temp -30°C/-22°F													
1	60	208	ICW-60-Q-LS ¹	✓	✓	0.33	67	90°C	10	Q	1.8	30	103
		277				0.24	67						
90W CosmoWhite Lamp, ANSI Code C188 Minimum Starting Temp -30°C/-22°F													
1	90	208	ICW-90-Q-LS ¹	✓	✓	0.49	99	90°C	10	Q	1.8	30	103
		277				0.37	99						
140W CosmoWhite Lamp, ANSI Code C189 Minimum Starting Temp -30°C/-22°F													
1	140	208	ICW-140-Q-LS ¹	✓	✓	0.75	153	90°C	10	Q	2.1	30	108
		277				0.57	153						

¹ Operates for a voltage range of 208-277V

² Based on initial lumens of Philips Cosmowhite lamps, CPO-T WHITE 45W, 60W, 90W, 140W/728, respectively

Refer to page 6-3 for lead wire information.
 Refer to pages 6-10 to 6-11 for ballast dimensions.
 Refer to page 6-9 for wiring diagrams.



MasterColor CDM Elite Medium Wattage

The Philips MasterColor Elite MW system offers a high level of light quality and performance. The lamp's sparkling white light creates a natural ambiance and brings out the best in all different types of colors. Additionally, the high efficiency of the lamp and ballast together means reduced energy use and a lower cost of ownership compared to a 250W or 400W metal halide HID system.**

High Efficiency

- Up to 120 lm/W (lamp) or 107 lm/W (system)
- 92% ballast efficacy

Light Quality

- Excellent color rendering of CRI 90+
- Crisp, white light in 3000K and 4200K CCT
- Stable color performance over the rated average life of the lamp
- New socket design enhances higher optical efficiency

Product Benefits

- Significant upgrade opportunity over traditional HID systems

- Viable alternative to fluorescent options
- Excellent color quality and consistent light output from beginning to end
- Being 50% smaller than traditional metal halide lamps gives freedom in optic and luminaire design
- Greater harmony in lighting design due to availability of Elite lamps in various wattages and two color temperatures
- Sparkling properties of white light create a more natural and inviting ambience
- High system energy efficacy: sound TCO
- Long average rated lamp life from 20,000 to 30,000 hours* for low maintenance cost
- True universal operation with no effect on life and color

Applications

- **Outdoor:** Architectural façade lighting, illumination of roads and pedestrian areas, public spaces and parking garages
- **Indoor:** High-bay retail, grocery stores, warehouses and manufacturing facilities



Lamp Data		Input Volts	Catalog Number	Certifications			Line Current (Amps)	Input Power ANSI (Watts)	Max. Case Temp.	Wiring Diag.	Fig.	Weight (lb)	Max. Distance to Lamp (ft)	Slide Switch Setting
Number	Watts			E	UL	SF								
210W MasterColor CDM Elite MW Lamp, ANSI Code C183 Minimum Starting Temp -20°C/-4°F														
														Preset at Factory
1	210	200	IZTMH-210315-R-LF ¹	✓	✓	✓	1.2	229	85°C	9	R	4.5	6	
		277					0.82	227						
1	210	347	HZTMH-210315-R-LF	✓	✓	✓	0.68	230	85°C	12	R	4.5	6	
		480					0.49	228						
315W MasterColor CDM Elite MW Lamp, ANSI Code C182 Minimum Starting Temp -20°C/-4°F														
1	315	200	IZTMH-210315-R-LF ¹	✓	✓	✓	1.8	343	85°C	9	R	4.5	6	
		277					1.25	341						
1	315	347	HZTMH-210315-R-LF	✓	✓	✓	1.02	344	85°C	12	R	4.5	6	
		480					0.73	342						

¹ Operates for a voltage range of 200-277V.
 * Rated average life is the life obtained, on average, from large representative groups of lamps in laboratory tests under controlled conditions at 10 or more operating hours per start. It is based on survival of at least 50% of the lamps, and allows for individual lamps or group of lamps to vary considerably from the average. CDM Elite MW 210/T12/930/O average rated life is 20,000 hours. CDM Elite MW 315/T9/942/U/E average rated life is 30,000 hours.

** Based on a comparison of published data of a Philips CDM EliteMW 315/T9/942/U/E lamp operated by Philips Advance IZTMH-210315-R-LF (341 System Watts) to a Philips MS400/BU/ED28/PS operated by a Philips Advance 71A6092AEE ballast (452 system Watts) operated for 30,000 hours (rated average life of 315W CDM Elite lamp).

Refer to page 6-3 for lead wire information.
 Refer to pages 6-10 to 6-11 for ballast dimensions.
 Refer to page 6-9 for wiring diagram.

Wiring Diagrams

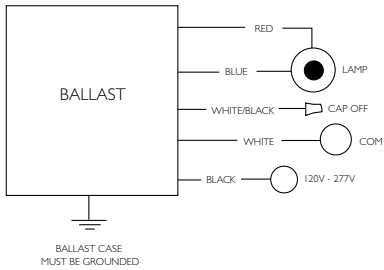

Wiring Diag. 1

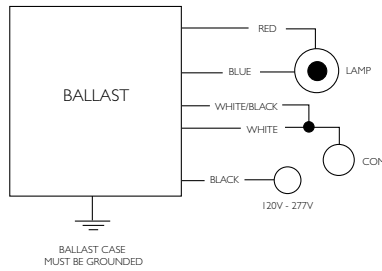

Wiring Diag. 2

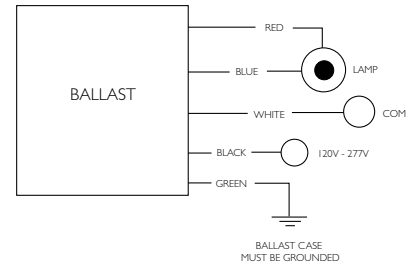

Wiring Diag. 3

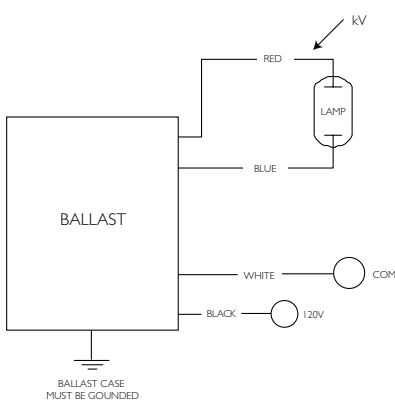

Wiring Diag. 4

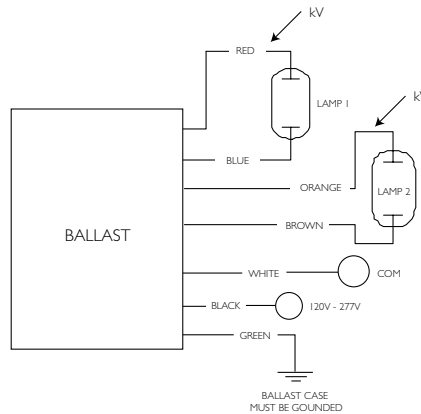

Wiring Diag. 5

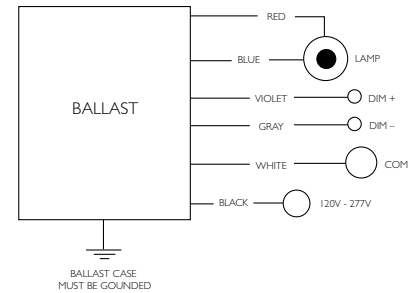

Wiring Diag. 6

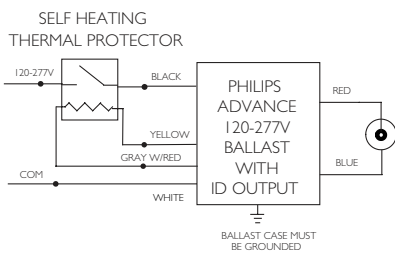

Wiring Diag. 8

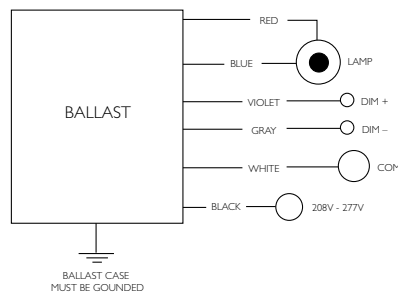

Wiring Diag. 9

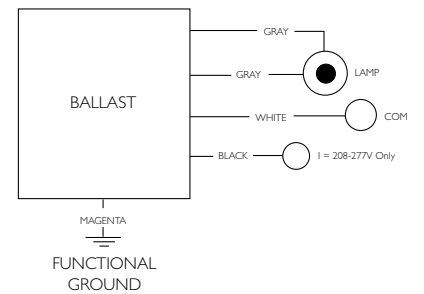

Wiring Diag. 10

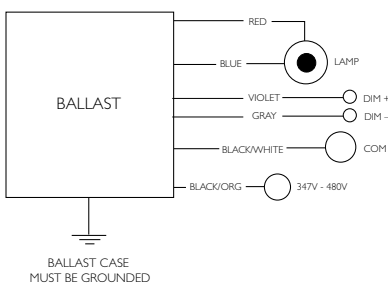

Wiring Diag. 12

Dimension Diagrams

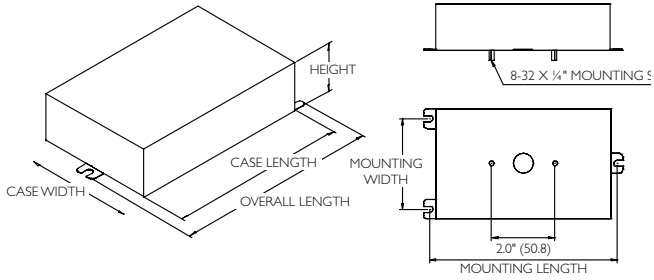

Figure	Overall Length	Length	Width	Height	Mounting Length	Mounting Width
A/B	140mm [5.5"]	120mm [4.7"]	92mm [3.6"]	38mm [1.5"]	132mm [5.2"]	73mm [2.9"]
H	161mm [6.3"]	144mm [5.7"]	92mm [3.6"]	38mm [1.5"]	152mm [6.0"]	73mm [2.9"]

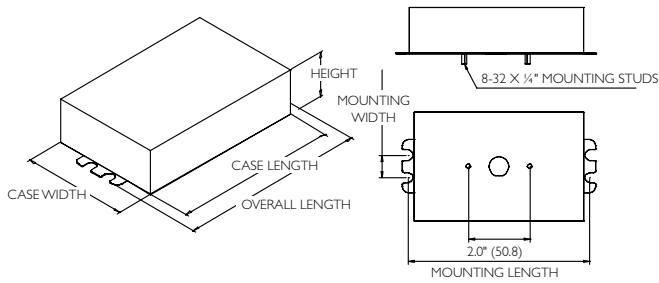

Figure	Overall Length	Length	Width	Height	Mounting Length	Mounting Width
D	128mm [5.0"]	108mm [4.3"]	77mm [3.0"]	38mm [1.5"]	118mm [4.6"]	19mm [0.7"]

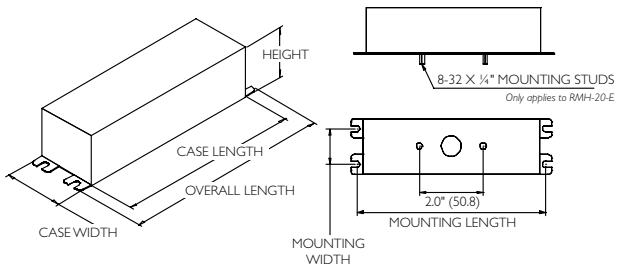

Figure	Overall Length	Length	Width	Height	Mounting Length	Mounting Width
E	140mm [5.5"]	127mm [5.0"]	44mm [1.7"]	30mm [1.2"]	135mm [5.3"]	26mm [1.0"]

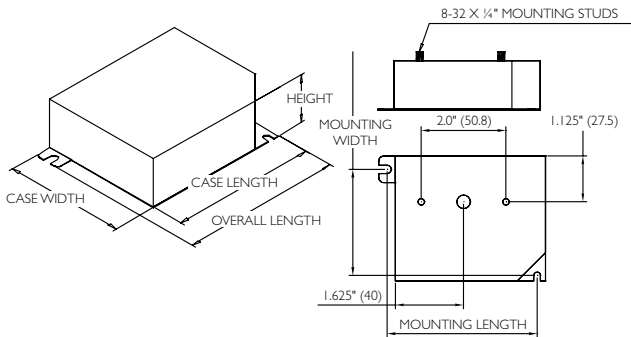

Figure	Overall Length	Length	Width	Height	Mounting Length	Mounting Width
G	97mm [3.8"]	90mm [3.5"]	77mm [3.0"]	30mm [1.2"]	87mm [3.4"]	67mm [2.6"]

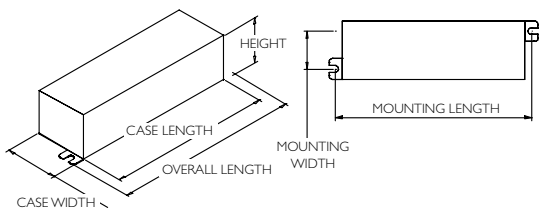

Figure	Overall Length	Length	Width	Height	Mounting Length	Mounting Width
K	119mm [4.7"]	104mm [4.1"]	33mm [1.3"]	30mm [1.2"]	114mm [4.5"]	13.5mm [0.5"]

Dimension Diagrams

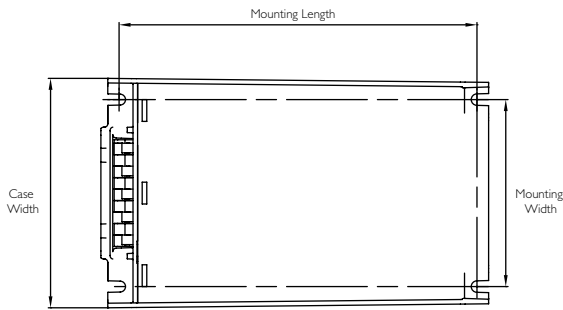

Figure	Overall Length	Length	Width	Height	Mounting Length	Mounting Width
Q	150mm [5.9"]	150mm [5.9"]	90mm [3.5"]	37mm [1.5"]	129mm [5.1"]	70mm [2.7"]

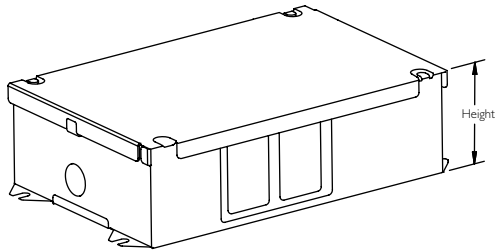
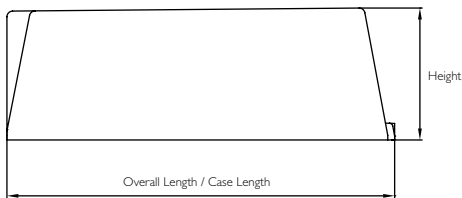
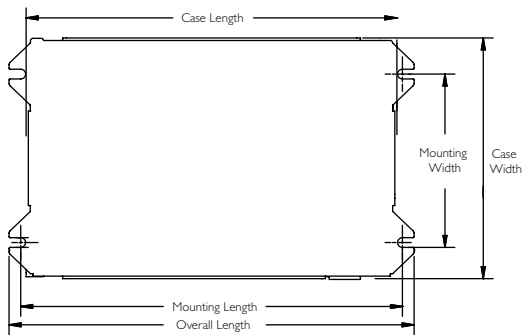

Figure	Overall Length	Length	Width	Height	Mounting Length	Mounting Width
R	208mm [8.2"]	191mm [7.5"]	124mm [4.9"]	56mm [2.2"]	192mm [7.7"]	86.5mm [3.4"]





Magnetic HID Ballasts

General information	7-1
Replacement Core & Coil ballast kits – U.S. voltages	7-4
Replacement Core & Coil ballast kits – Canadian voltages	7-8
Val-U-Pak Plus ballast/Lamp replacement kits	7-9
Core & Coil ballasts (71A series)	7-11
Capacitors for bi-level operation	7-37
Ballast to lamp remote mounting distances	7-39
Ignitors	7-40
Transformers and autotransformers	7-44
F-Can ballasts (72C series)	7-45
Encapsulated Core & Coil ballasts (73B series)	7-48
Postline ballasts (74P series)	7-51
Indoor enclosed ballasts (78E series)	7-53
Outdoor weatherproof ballasts (79W series)	7-55
International Magnetic HID ballasts	7-57

Corporate Offices
(800) 322-2086

Customer Support/Technical Service
(800) 372-3331 • (+) 1 847 390-5000 (International)

Visit our web site at www.philips.com/oemna.

Note: For Electronic HID Ballasts, See Section 6.

Philips Advance HID ballasts are available to operate the wide variety of metal halide, high pressure sodium and low pressure sodium lamps available in today's marketplace.

Like fluorescent, HID lamps are gas discharge lamps. Light is produced by an arc discharge between two electrodes located at opposite ends of an arc tube within the lamp's outer glass envelope. The ballast is the lamp's power supply; its purpose is to provide proper starting and operating voltage and current to initiate and sustain this arc.

Lamp Starting

Probe-Start Metal Halide Lamps

The "traditional" probe-start metal halide lamps (175 through 1500W) have an additional electrode located at one end of the arc tube to assist in lamp starting. These types of lamps require an open circuit voltage (OCV) approximately two times the lamp's operating voltage to initiate the arc.

High Pressure Sodium and Pulse-Start Metal Halide Lamps

High pressure sodium and modern metal halide lamps, which include existing lamps, 150W and less, as well as the new generation of pulse-start metal halide lamps, 150W and greater, have no starting electrodes. In addition to an OCV of approximately two times the lamp voltage, these lamps utilize an "ignitor" to provide a high voltage starting pulse directly across the main electrodes. Once the lamp's arc is established, the ignitor automatically stops delivering pulses, and the lamp comes up to full brightness on its own.

Low Pressure Sodium

Because they have neither a starting electrode nor an ignitor, low pressure sodium lamps require an open circuit voltage approximately three to seven times the lamp voltage to start and sustain the lamp.

Lamp Operation

Gas discharge lamps have a negative resistance characteristic that causes them to draw an increasing amount of current leading to immediate lamp failure if operated directly from the power line. The ballast, therefore, is utilized to limit the current to the correct level for proper operation of the lamp.

Ballast factor is defined as the ratio of light output produced by a lamp operating on a commercial ballast versus the lamp's rated light output. Philips Advance HID ballasts have a nominal ballast factor of 1.0, thus providing full light output.

HID lamps take several minutes to warm-up and reach full lumen output. Additionally, an interruption in the input power or a sudden voltage drop may cause the arc to extinguish. A lamp that is hot will not restart immediately. Before the lamp will relight, it must cool sufficiently to reduce the vapor pressure within the arc tube to a point where the arc will restrike. The approximate warmup and restriking times of the HID lamp groups are as follows:

Light Source	Warm-Up Time	Restrike Time
Metal Halide (Probe Start)	5-4 minutes	10-20 minutes
Metal Halide (Pulse Start)	2 minutes	3-4 minutes
High Pressure Sodium	3-4 minutes	½-1 minute
Low Pressure Sodium	7-10 minutes	3-12 seconds

Ballast Input Voltages

Unlike fluorescent lighting which is operated on either 120V or 277V circuits, power for HID lighting in the U.S. is delivered at any one of five voltages: 120V, 208V, 240V, 277V or 480V. While 120V and 277V are the most popular, because of the heavier loads and sometimes longer runs associated with HID lighting (such as shopping mall parking lots), 208V and 240V power is often used instead of 120V, and 480V instead of 277V.

To address this multiplicity of voltages, the HID ballast industry offers ballasts with multiple input voltage taps on the primary coil. Our 4-TAP design is called a Quadri-Volt ballast and operates on either 120V, 208V, 240V or 277V line voltage. There is a Philips Advance Quadri-Volt ballast for virtually every HID lamp on the market. New 5-TAP designs, which feature the same input voltages as Quadri-Volt ballasts plus 480V, are available for 250W, 400W and 1000W metal halide and high pressure sodium applications.

Luminaires Fusing

Many HID lighting luminaires are sold with protective fuses. The purpose of the fuse is to isolate a luminaire from the lighting circuit in the event of excessive current draw, such as might be caused by a failed ballast. Unfortunately, the fuse will not protect the ballast from failure.

With many luminaires the fuse is physically located in the ballast compartment of the luminaire. The air temperature within this compartment can easily reach 80°C and still be within the design limitations of the luminaire.

Many fuses are temperature sensitive, meaning that the current rating goes down as the ambient temperature goes up. Fuse current ratings are based on the fuse's performance in a 25°C ambient (77°F). In an 80°C ambient, some fuses will open at half their rating.

As a result, the fuse rating shown in the HID ballast tables is calculated at 2½ to 3 times the highest current draw of the ballast: lamp operating, starting or open circuit conditions. Typically fast blow fuses should be used. It is not necessary to use current limiting fuses but some applications may require their use. Additional testing is recommended to determine appropriate fuse type.

Ballast Design Applications

HID lamp ballasts are available in a variety of shapes and sizes for the most popular lighting applications. Six basic designs are in widest use today.

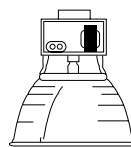

Core & Coil
(71A Series)

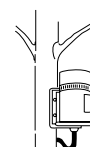

Outdoor
Weatherproof
(79W Series)



Postline
(74P Series)

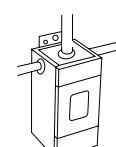

Indoor Enclosed
Rectangular Can
(78E Series)

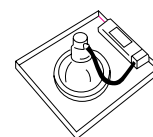

Fluorescent Can
(72C Series)

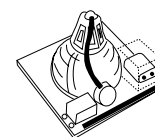

Encapsulated Core & Coil
(73B Series)

Core & Coil

The basic ballast is the open core & coil, which is most often used as a component within a lighting luminaire. The core & coil also forms the nucleus of the five other ballast configurations detailed in this section. It consists of either one or two copper coils on a core (or “stack”) of electrical-grade steel laminations. The coils are assembled to core sections that are then surface-welded together. The assembled Philips Advance ballast is vacuum-pressure impregnated with a silica-filled polyester varnish to re-enforce the electrical insulation, preclude moisture, inhibit noise and dissipate heat. Some HID ballast manufacturers apply varnish via a preheat-and-dip process, which only puts a thin coat of varnish on the outer surface of the ballast. Philips Advance core & coil ballasts feature as standard an insulation system rated class H (180°C maximum coil hot spot temp.) for ballasts below 600W and Class N (200°C maximum coil hot spot temp.) for ballasts 600W and higher. When performing in-fixture testing, the maximum allowable average coil temperature (measured by the rise-of-resistance method) is 165°C for Class H ballasts or 185°C for Class N ballasts. The maximum allowable coil face or lead wire temperature (measured by thermocouple) is 150°C for both Class H and Philips Advance Class N ballasts, 170°C for true Class N ballasts.

Encapsulated Core & Coil

Where quiet performance is required, the standard open core & coil ballasts are encapsulated (potted) in a cube-shaped steel can utilizing Class H (180°C) polyester compound. These ballasts carry a Class A noise rating up through 175W and Class B for 250 and 400W. As with the open core & coil, the capacitor (and ignitor where included) are mounted separately within the fixture.

Ballasts with Aluminum Coils

We offer a wide range of ballasts that have coils made out of copper and/or aluminum. All Philips Advance ballasts adhere to ANSI specifications and are certified by respective agencies (UL, CSA, etc.). Ballasts with aluminum coil(s) are designated by -A after ballast catalog number and/or “AL” on wiring diagram.

Fluorescent Can (F-Can)

For indoor commercial applications of HID lighting such as offices, schools and retail stores, ballast noise must be minimized. Ballasts for these luminaires are most often encased and potted in fluorescent ballast type cans and utilize Class A (90°C) asphalt insulating materials (the same as used in fluorescent lamp ballasts).

The Philips Advance line of F-can ballasts comes in two dual-voltage configurations: 120/277V for the US market and 120/347V for the Canadian market. Each unit has built-in, automatically resetting thermal protectors that disconnect the ballast from the power line in the event of overheating. All units are high power factor and include the capacitor within the can. All models for high pressure sodium, low-wattage metal halide and pulse-start metal halide lamps also include the ignitor in the can.

Spacing between ballasts and the mounting surface must be considered when the ballasts are remote-mounted.

Twelve inches between ballasts must be maintained, and if multiple rows vertically are used, there should be at least 12 inches between rows. In addition to ballast and row spacing, the ballast must not be directly mounted to a non-metallic surface. They must be spaced with mounting brackets (see page 7-46 and 7-47 for mounting bracket details) to allow airflow under the ballast base.

Indoor Enclosed

These units are designed for use indoors where the ballast must be mounted remotely from the luminaire. They are most typically used in factories where the luminaire may be mounted in a high-bay where very high ambient temperatures may be experienced. In these instances, the remotely mounted ballast operates cooler, subsequently providing longer life because it is away from both the heat of the ceiling ambient and lamp heat within the fixture.

The case contains the core & coil potted in a Class H (180°C) heat-dissipating resin. The capacitor(s) and ignitor are contained within a separate compartment. Knockouts in both ends of the case facilitate hook-up in the most convenient manner. Wall mounting is accomplished through flanges on the top and bottom of the case. The ballast is a UL Listed product.

Outdoor Weatherproof

Weatherproof ballasts are designed for remote, pole-mounting outdoor applications under all weather conditions. They may also be placed inside of a transformer pole base, but care must be taken to avoid areas prone to flooding because weatherproof ballasts are not water-submersible.

The core & coil with its capacitor and ignitor (where required) are firmly mounted to the heat-sink base. An aluminum cover is placed over the core-&-coil assembly and is bolted with a weather-tight gasket to the base. Using the integral 1” threaded nipple with the provided locknut facilities hook-up to the electrical conduit or to the mounting bracket when used on a pole. The weatherproof ballast may also be placed nipple-up, with a drip loop in the leads, inside a pole base.

Postline

Lantern-type fixtures mounted on slender poles often require ballasts that will fit into these poles. Special, elongated core & coil ballasts are potted in resin in cylindrical cans having a 2.55” outside diameter. All include leads necessary for direct connection to a photocell.

The capacitor and ignitor (where required) are included within this can. A ½” threaded nipple is used for vertical mounting, and leads extend from both ends of the can for ease of installation. The input leads to the ballast also provide for proper connection to the photocell if such is included within the luminaire.

To help prevent overheating, one to three feet of air space should be allowed in the pole above the ballast, and the ballast should be positioned against the post interior wall to provide a heat-sink. All units rated 100W and above now include a mounting kit consisting of an 18” chain to hang the ballast within the pole and a spring clip to force the ballast’s cylindrical can to make line contact with the pole’s interior surface to maximize heat transfer, thus prolonging the ballast life.

Ballast Date and Temperature Codes

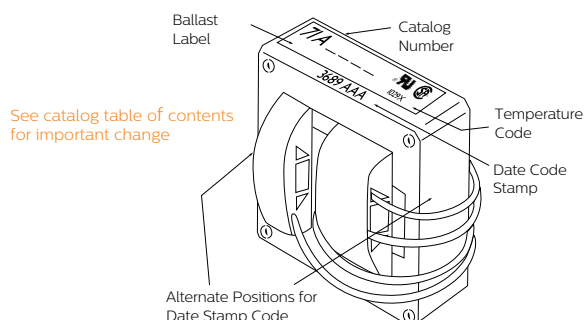

Philips Advance HID core & coil ballasts are date stamped on either the top surface or the side surface of the ballast core. The four-digit number represents the week and year of manufacture. The first two numbers indicate the week and the last two indicate the year the ballast was manufactured. The example shows a ballast manufactured during the 36th week of 1989. The three letters are a factory code.

The ballast's UL Bench Top Rise Temperature Code is shown on the label (see above).

UL Bench Top Rise Temperature Code

To facilitate UL inspection, each ballast's UL Bench Top Rise Temperature Code is shown on the Philips Advance core & coil ballast label as 1029X, where 1029 is the UL Standard for HID Ballasts and the X is the temperature code: A, B, C, etc. If a fixture is UL listed for 1029C, then automatically all ballasts with an A, B or C temperature classification are acceptable for use within that same fixture.

If a fixture is UL listed at a specific wattage such as UL 1029C, all ballasts of the same wattage with an A, B or C temperature classification are acceptable for use within that fixture. A ballast with a higher temperature classification (D, E, F, etc.) is not acceptable for use within that same fixture. A ballast with a higher wattage rating than the listed fixture wattage rating is also not acceptable for use and cannot be installed, regardless of the ballast temperature classification.

Reactor ballasts utilizing integral ignitors are thermally protected to limit the maximum ignitor component temperature within the fixture. They have a lower maximum operating temperature limit than a reactor ballast with an external ignitor. When replacing a reactor ballast using an external ignitor with a reactor ballast using an integral ignitor, it is recommended that in-fixture thermal testing is

UL Bench Top Rise Letter Code	Temperature Range for Class H (180°C) Ballasts	Temperature Range for Class N (200°C) Ballasts
A	less than 75°C	less than 95°C
B	75°C < 80°C	95°C < 100°C
C	80°C < 85°C	100°C < 105°C
D	85°C < 90°C	105°C < 110°C
E	90°C < 95°C	110°C < 115°C
F	95°C < 100°C	115°C < 120°C
etc.	etc.	etc.

performed which simulates the application to ensure that the thermally protected reactor does not cycle in the fixture causing the lamp to drop out.

Certifications



Indicates ballast is listed by Underwriters Laboratories, Inc. in accordance with UL 1029 Standard for HID Ballasts. Each ballast is marked appropriately. (UL File Number E94520)



Indicates ballast is component recognized by Underwriters Laboratories, Inc. in accordance with UL 1029 Standard for HID Ballasts. Each ballast is marked appropriately.



Indicates ballast is certified by Canadian Standards Association in accordance with CAN/CSA-22.2 No. 74-92. Each ballast is marked appropriately.



All HID Ballasts are designed and manufactured in accordance with the American National Standards Institute Standard for HID Ballasts, ANSI C82.4.



Indicates ballast is certified and compliant with "Norma Obligatoria Mexicana" (NOM) requirements.



Indicates ballast meets the 88% efficiency requirements of EISA (Energy Independence and Security Act of 2007).

EISA requires all 150W-500W metal halide luminaires manufactured on or after January 1, 2009, to contain a ballast meeting the following levels of efficiency:

- 88% for magnetic or electronic pulse start ballasts
- 94% for magnetic probe start ballasts
- 92% for non-pulse start electronic ballasts for wattages greater than 250W, and
- 90% for non-pulse start electronic ballasts for wattages up to 250W

Please refer to the EISA brochure for more information on EISA Compliant pulse-start ballasts. It can be found at www.philips.com/oemna. In February 2017, the DoE will require new fixtures for Pulse Start Metal Halide ballasts, ranging from 35W to 1000W, to be more energy efficient than they are presently. Probe Start Metal Halide ballasts will not be permitted in new fixtures, within the above wattage range. Replacement ballasts for existing fixtures are not affected by this rule making. Please contact your local Philips sales representative for a list of compliant ballasts.

Restrictions on Hazardous Substances (RoHS) is a European directive (2002/95/EC) designed to limit the content of 6 substances [lead, mercury, cadmium, hexavalent chromium, polybrominated biphenyls (PBB), and polybrominated diphenyl ethers (PBDE)] in electrical and electronic products.



Core & Coil Replacement Kits

Distributor Kits and Replacement Ignitors

Philips furnishes 120/208/240/277 Philips Advance Quadri-Volt core & coil ballasts to allow the stocking distributor to conveniently meet the replacement and retrofit needs of customers. In addition, we now offer 120/208/240/277/480V 5-TAP core & coil ballasts for the most popular applications. 5-TAP ballasts add the 480V input lead to the Quadri-Volt designs. A Quadri-Volt or 5-TAP core & coil, along with the appropriate capacitor, ignitor (where required), mounting bracket & hardware and installation instructions are packed in a space-saving shipping carton. These “kits” eliminate the need for distributors or end-users to stock loose components of single voltage ballasts for 120, 208, 240, 277 and even some 480V applications, though single voltage kits for 480V applications will also be available.

Ignitors are also packaged in individual cartons for replacement needs. There are several different ignitors to meet the needs of the many different lamps. The appropriate ignitor for each ballast is shown near the far right column on the pages 7-11 through 7-34 and 7-59 through 7-60. Additionally, this information is summarized in the tables on pages 7-40 through 7-43.

Dry Capacitors

We have extended the operating voltage range of our dry capacitors from 330V to 400V. This means that our most popular HID replacement kits for 175, 250 and 400W metal halide lamps now contain dry capacitors and offer the additional benefits available only with a dry capacitor.

Those benefits are:

- Dry capacitors are typically 25 to 50% smaller than their oil-filled counterparts, allowing the Philips Advance ballast kit to fit existing fixtures.
- Dry capacitors are rated 105°C, 15°C higher than 90°C oil-filled capacitors, thus providing longer component life.
- Dry capacitors are built using a thermoplastic case, thus eliminating the need for grounding and providing a faster, easier replacement.
- Unlike oil-filled capacitors with exposed tab terminals, dry capacitors have no exposed live parts and thus protect end-users from hazardous voltages.

The bottom line is that our expanded use of dry capacitors makes the contractor's job faster and easier. Look for the “D” at the end of our catalog number; it identifies the ballast kit as one that contains a dry capacitor.



Pre-wired Ignitor Connectors for Capacitor Dry Capacitor Now Rated 105°C

Capacitor Size Comparison Oil-Filled vs. Advance Dry Type

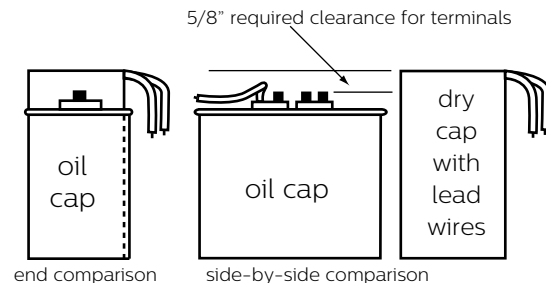



Core & Coil Replacement Kits



Pulse Start Metal Halide

Input Volts	Catalog Number	Circuit Type	Total Weight (Lbs)	Certifications		
						
35W/39W Lamp, ANSI Code M130 (Pulse Start)						
120/277	71A5081-001D	HX-HPF	4.0	✓	✓	✓
50W Lamp, ANSI Code M110 or M148 (Pulse Start)						
120/277	71A5181-001D	HX-HPF	4.9	✓	✓	✓
120/208/240/277	71A5191-001D	HX-HPF	4.9	✓	✓	✓
70W Lamp, ANSI Code M98 or M143 (Pulse Start)						
120/208/240/277	71A5292-001D	HX-HPF	5.5	✓	✓	✓
100W Lamp, ANSI Code M90 or M140 (Pulse Start)						
120/208/240/277	71A5390-001D	HX-HPF	5.6	✓	✓	✓
150W Lamp, ANSI Code M102 or M142 (Pulse Start)						
120/208/240/277	71A5492-001D	HX-HPF	7.8	✓	✓	✓
175W Lamp, ANSI Code M137 or M152 (Pulse Start)						
120/208/240/277	71A5593-001D	Super CWA	8.0	✓	✓	✓
200W Lamp, ANSI Code M136 (Pulse Start)						
120/208/240/277	71A5692-001D	Super CWA	8.6	✓	✓	✓
250W Lamp, ANSI Code M138 or M153 (Pulse Start)						
120/208/240/277	71A5792-001D	Super CWA	10.3	✓	✓	✓
120/208/240/277/400	71A5752-001D	Super CWA	11.5	✓	✓	✓
320W Lamp, ANSI Code M132, M154 or M170 (Pulse Start)						
120/208/240/277	71A5892-001D	Super CWA	11.4	✓	✓	✓
480/120T	71A5842-001DT	Super CWA	11.3	✓	✓	✓
350W Lamp, ANSI Code M131 or M171 (Pulse Start)						
120/208/240/277	71A5993-001D	Super CWA	11.5	✓	✓	✓
400W Lamp, ANSI Code M135 or M155 or M172 (Pulse Start)						
120/208/240/277	71A6092-001D	Super CWA	13.2	✓	✓	✓
480/120T	71A6042-001D	Super CWA	13.0	✓	✓	✓
120/208/240/277/480	71A6052001D	Super CWA	16.0	✓	✓	✓

Pulse Start Metal Halide

Input Volts	Catalog Number	Circuit Type	Total Weight (Lbs)	Certifications		
						
750W Lamp, ANSI Code M149 (Pulse Start)						
277/347/480/120T	71A64F2-001D	Super CWA	19.0	✓	✓	✓
120/208/240/277/480	71A6452-001D	Super CWA	20.2	✓	✓	✓
1000W Lamp, ANSI Code M141 (Pulse Start)						
120/208/240/277	71A6593-001	Super CWA	23.1	✓	✓	✓
120/208/240/277/480	71A6553-001	Super CWA	24.0	✓	✓	✓
347/480/120T	71A65F3-001	Super CWA	22.0	✓	✓	✓

Metal Halide

Input Volts	Catalog Number	Circuit Type	Total Weight (Lbs)	Certifications		
						
175/150W Lamp, ANSI Code M57/M107						
120/208/240/277	71A5570-001D	CWA	7.5	✓	✓	✓
480	71A5540-001D	CWA	7.5	✓	✓	✓
250W Lamp, ANSI Code M58						
120/208/240/277	71A5770-001D	CWA 4x4 Core	10.0	✓	✓	✓
120/208/240/277/480	71A5750-001D		10.3	✓	✓	✓
120/208/240/277	71A5771-001D	CWA 3x3 Core	10.0	✓	✓	✓
480	71A5741-001D		10.0	✓	✓	✓
400W Lamp, ANSI Code M59						
120/208/240/277	71A6071-001D	CWA	12.0	✓	✓	✓
120/208/240/277/480	71A6051-001D	CWA	13.1	✓	✓	✓
480/120T	71A6041-001D	CWA	12.7	✓	✓	✓
1000W Lamp, ANSI Code M47						
120/208/240/277	71A6572-001	CWA	21.4	✓	✓	✓
120/208/240/277/480	71A6552-001	CWA	26.0	✓	✓	✓
480/120T	71A6542-001	CWA	21.3	✓	✓	✓
1500W Lamp, ANSI Code M48						
120/208/240/277	71A6772-001	CWA	31.6	✓	✓	✓
480/120T	71A6742-001	CWA	31.8	✓	✓	✓

Core & Coil Replacement Kits

High Pressure Sodium

Input Volts	Catalog Number	Circuit Type	Total Weight (Lbs)	Certifications		
				UL	SP	RoHS COMPLIANT
35W Lamp, ANSI Code S76						
120	71A7707-001DB	R-HPF	1.7	✓	✓	✓
50W Lamp, ANSI Code S68						
120	71A7807-001DB	R-HPF	2.0	✓	✓	✓
120/277	71A7801-001D	HX-HPF	4.7	✓	✓	✓
120/208/240/277	71A7891-001D	HX-HPF	4.3	✓	✓	✓
70W Lamp, ANSI Code S62						
120	71A7907-001DB	R-HPF	2.7	✓	✓	✓
120/208/240/277	71A7971-001D	HX-HPF	5.6	✓	✓	✓
100W Lamp, ANSI Code S54						
120	71A8007-001DB	R-HPF	3.6	✓	✓	✓
120/208/240/277	71A8071-001D	HX-HPF	6.9	✓	✓	✓
120/208/240/277	71A8091-001DC	HX-HPF	7.3	✓	✓	✓
480	71A8041-001D	HX-HPF	7.9	✓	✓	✓
150W Lamp, ANSI Code S55						
120	71A8107-001DB	R-HPF	4.0	✓	✓	✓
120/208/240/277	71A8172-001D	HX-HPF	8.2	✓	✓	✓
120/208/240/277	71A8192-001DC	HX-HPF	8.6	✓	✓	✓
480	71A8142-001D	HX-HPF	10.0	✓	✓	✓
150W Lamp, ANSI Code S56						
120/208/240/277	71A8176-001D	CWA	8.5	✓	✓	✓
480	71A8146-001D	CWA	8.5	✓	✓	✓

HPS Kit Options

In addition to the standard kits, this and the following page include two HPS kits with special features.

HPS Reactor Kits with Integral Ignitors

“B” suffix denotes 120V reactor circuit kits featuring single-coil reactor ballasts with integral ignitors. The kit includes a mounting bracket (PC848S) sized specifically for the small reactor ballasts.

Compact Reactor Core and Bracket



HPS Kits with Plug-In Ignitors

“C” suffix (p. 7-6 and p. 7-7) denotes standard HPS kit except with plug-in ignitor. A mating receptacle is attached to the core and coil lead wires, ready for immediate connection.

Connectorized ignitor and mating receptacle

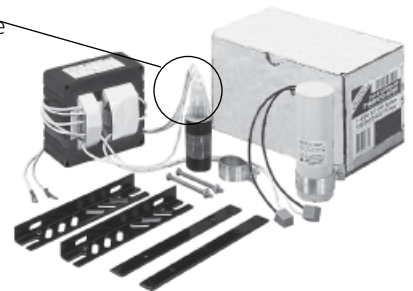

Core & Coil Mounting Brackets

Included with all Replacement Kits

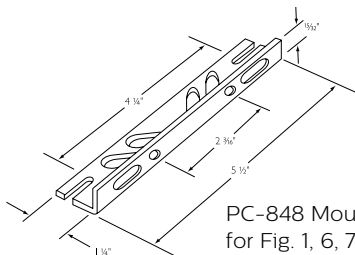

PC-848 Mounting bracket for Fig. 1, 6, 7 & 9.

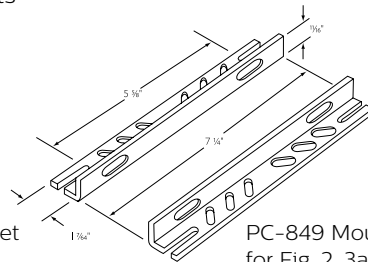

PC-849 Mounting bracket for Fig. 2, 3a, 8, 8a & 10.

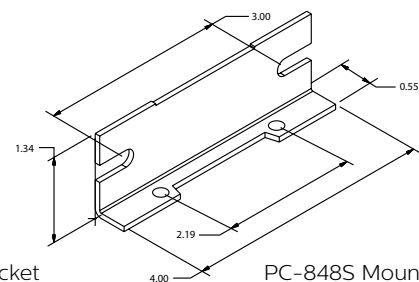

PC-848S Mounting bracket for Fig. 9.

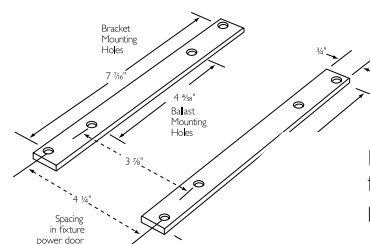

- PC-848: To order individual packaged kits, specify PKG 848 (1 brackets with thru bolts).
- PC-849: To order individual packaged kits, specify PKG 849-2 (2 brackets with thru bolts).
- PC-848S: Bracket and thru bolts are included in 120V HPS Reactor Kits.





PC-909 Mounting bracket for Fig. 2, 3a & 8 when used with power-door roadway fixtures.

Core & Coil Replacement Kits

High Pressure Sodium

Input Volts	Catalog Number	Circuit Type	Total Weight (Lbs)	Certifications		
						
200W Lamp, ANSI Code S66						
120/208/240/277	71A8970-001D	CWA	9.4	✓	✓	✓
250W Lamp, ANSI Code S50						
120/208/240/277	71A8271-001D	CWA	11.5	✓	✓	✓
120/208/240/277/480	71A8251-001D	CWA	12.4	✓	✓	✓
480	71A8241-001D	CWA	11.5	✓	✓	✓
400W Lamp, ANSI Code S51						
120/208/240/277	71A8473-001D	CWA	15.7	✓	✓	✓
120/208/240/277/480	71A8453-001D	CWA	17.2	✓	✓	✓
120/208/240/277	71A8493-001DC	CWA	15.5	✓	✓	✓
480	71A8443-001D	CWA	16.5	✓	✓	✓
1000W Lamp, ANSI Code S52						
120/208/240/277	71A8773-001	CWA	29.7	✓	✓	✓
120/208/240/277/480	71A8753-001	CWA	30.7	✓	✓	✓
480	71A8743-001	CWA	30.3	✓	✓	✓

Low Pressure Sodium

Input Volts	Catalog Number	Circuit Type	Total Weight (Lbs)	Certifications		
						
35 or 55W Lamp, ANSI Code L70 or L71						
120/208/240/277	71A0490-001D	HX-PFC	7.5	✓	✓	✓

Core & Coil Mounting Brackets
Included with all Replacement Kits

Tri-Tap Replacement Core & Coil Kits for Canada



Metal Halide

Input Volts	Catalog Number	Circuit Type	Total Weight (Lbs)	Certifications		
				UL	SP	RoHS COMPLIANT
70W Lamp, ANSI Code M98						
120/277/347	71A52A2-001D	HX-HPF	5.7	✓	✓	✓
100W Lamp, ANSI Code M90						
120/277/347	71A53A0-001D	HX-HPF	6.5	✓	✓	✓
175/150W Lamp, ANSI Code M57/M107						
120/277/347	71A55A0-001D	CWA	7.5	✓	✓	✓
250W Lamp, ANSI Code M58						
120/277/347	71A57A0-001D	CWA	10.3	✓	✓	✓
400W Lamp, ANSI Code M59						
120/277/347	71A60A1-001D	CWA	13.0	✓	✓	✓
1000W Lamp, ANSI Code M47						
120/277/347	71A65A2-001	CWA	22.4	✓	✓	✓

High Pressure Sodium

Input Volts	Catalog Number	Circuit Type	Total Weight (Lbs)	Certifications		
				UL	SP	RoHS COMPLIANT
70W Lamp, ANSI Code S62						
120/277/347	71A79A1-001D	HX-HPF	5.5	✓	✓	✓
100W Lamp, ANSI Code S54						
120/277/347	71A80A1-001D	HX-HPF	7.5	✓	✓	✓
150W Lamp, ANSI Code S55						
120/277/347	71A81A2-001D	HX-HPF	8.2	✓	✓	✓
250W Lamp, ANSI Code S50						
120/277/347	71A82A1-001D	CWA	11.5	✓	✓	✓
400W Lamp, ANSI Code S51						
120/277/347	71A84A3-001D	CWA	18.3	✓	✓	✓
1000W Lamp, ANSI Code S52						
120/277/347	71A87A3-001	CWA	30.3	✓	✓	✓

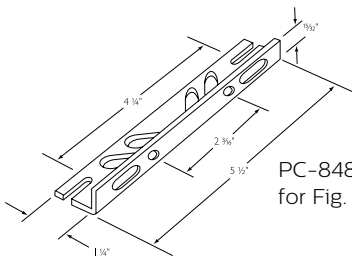

PC-848 Mounting bracket for Fig. 1, 6, 7 & 9.

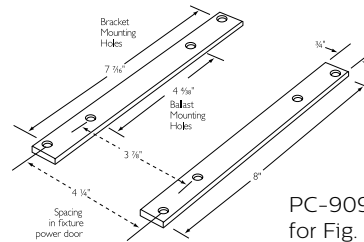

PC-909 Mounting bracket for Fig. 2, 3a & 8 when used with power-door roadway fixtures.

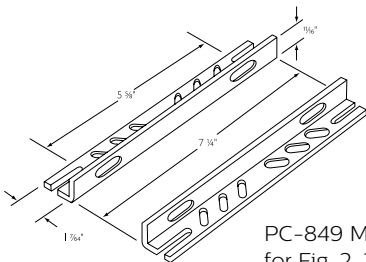

PC-849 Mounting bracket for Fig. 2, 3a, 8, 8a & 10.

- PC-848: To order individual packaged kits, specify PKG 848 (1 brackets with thru bolts).
- PC-849: To order individual packaged kits, specify PKG 849-2 (2 brackets with thru bolts).
- PC-848S: Bracket and thru bolts are included in 120V HPS Reactor Kits.

HID Val-U-Pak Plus Replacement Kits

Val-U-Pak Plus

HID installations just got simpler, more convenient and significantly faster with the new Val-U-Pak Plus kits.

Why Should You Change All the Components?

HID fixtures are generally difficult to reach and to service. Subsequently, the cost of labor can often exceed the cost of the ballast and/or lamp. When the ballast, capacitor or ignitor reaches end-of-life, it is recommended that all of these components in the fixture be replaced at the same time. It is equally suggested that the lamp also be replaced, assuring optimal performance of the system and eliminating the need to re-service the fixture during the entire life-cycle of the lamp.



Metal Halide

Input Volts	Catalog Number	Circuit Type	Total Weight (Lbs)	Certifications		
				UL	CS	RoHS COMPLIANT
100W Lamp, ANSI Code M90 or M140 (Pulse Start)						
120/208/240/277	77L5390-001D	HX-HPF	7.6	✓	✓	✓
150W Lamp, ANSI Code M102 or M142 (Pulse Start)						
120/208/240/277	77L5492-001D	HX-HPF	9.6	✓	✓	✓
175/150W Lamp, ANSI Code M57/M107						
120/208/240/277	77L5570-001D	CWA	9.5	✓	✓	✓
250W Lamp, ANSI Code M58						
120/208/240/277/480	77L5750-001D	CWA	11.9	✓	✓	✓
400W Lamp, ANSI Code M59						
120/208/240/277/480	77L6051-001D	CWA	17.0	✓	✓	✓
1000W Lamp, ANSI Code M47						
120/208/240/277/480	77L6552-001	CWA	29.6	✓	✓	✓

Features of Val-U-Pak Plus:

- **Added Versatility** – 5-Tap core and coil ballast for the six most popular applications
 *Adds the 480V input lead to the Quadri-Volt design
- **All Inclusive** – Premium grade clear lamp supplied in kit is covered by a limited warranty from Philips Lighting Electronics N.A.
- **Higher Wattage Options** – Philips Advance Class N (200°C) insulation system on 1000W units provides an additional 20°C margin for high ambient applications.

High Pressure Sodium

Input Volts	Catalog Number	Circuit Type	Total Weight (Lbs)	Certifications		
				UL	CS	RoHS COMPLIANT
150W Lamp, ANSI Code S55						
120/208/240/277	77L8172-001D-MOG	HX-HPF	10.2	✓	✓	✓
250W Lamp, ANSI Code S50						
120/208/240/277/480	77L8251-001D	CWA	14.1	✓	✓	✓
400W Lamp, ANSI Code S51						
120/208/240/277/480	77L8453-001D	CWA	17.2	✓	✓	✓
1000W Lamp, ANSI Code S52						
120/208/240/277/480	77L8753-001	CWA	34.0	✓	✓	✓

Ordering Information

We have developed the industry's broadest selection of HID ballasts. More than 3000 stocking distributors nationwide. For information on the distributor best able to serve your needs, please call 800-372-3331.

Philips Advance HID Ballast Part Number Explanation

71A	60	9	2	-500DAEE	
				Suffix Code* (as applicable)	
				-001DB ballast replacement kit with dry capacitor and integral ignitor -001D ballast replacement kit with dry film capacitor -001 ballast replacement kit with oil filled capacitor -500D core & coil ballast with dry film capacitor -500 core & coil ballast with oil filled capacitor -510D core & coil ballast with welded bracket and dry film capacitor -510 core & coil ballast with welded bracket and oil filled capacitor -540D core & coil ballast with welded angle bracket and dry film capacitor -600 core & coil ballast (no capacitor) -610 core & coil ballast with welded bracket (no capacitor)	
				* Add additional feature codes to the end of suffix where applicable. i.e. -B = Integral Ignitor, -P = Thermally Protected, -J = J-Box Mounting, -A = Aluminum Coil, -ML = "NOM" (with capacitor), -T = 120V Tap -EE = EISA Compliant Ballast	
				Design Code	
				60 Hz Voltages	50 Hz Voltages
Input Voltage Code			0 = 120V 1 = 208V 2 = 240V 3 = 277V 4 = 480V 5 = 120/240V or 120/208/240/277/480V 6 = 240/480V 7 = 120/208/240/277V 8 = 120/277V 9 = 120/208/240/277V	A = 120/277/347V B = 347V C = 120/347V D = 120/240/347V E = 120/208/240V or 208/240V F = 277/480V, 277/347V, 277/347/480V or 347/480V H = 127/220V J = 220V or 220/240V Y = 100V, 100/200V or 230/400/480	M = 100/200V N = 120/220-240V R = 220/240V
				Lamp Type/Wattage/Ballast Circuit Code	
Ballast Type			71A = Core and Coil Ballast 72C = F-Can Ballast 73B = Encapsulated Core and Coil Ballast 74P = Postline Ballast 77L = Val-U-Pak Plus Replacement Ballast kit (includes lamp) 78E = Indoor Enclosed Ballast 79W = Outdoor Weatherproof Ballast		

60 Hz Core & Coil Ballasts

Metal Halide



Input Volts	Catalog† Number	Circuit Type	Input Watts	Max* Input Current	Nom Open Circuit Voltage	Fuse Rating (Amps)	Wiring Dia	Dimensions			Non-PCB Capacitor (Page 7-37 & 7-38)				Ignitor †† (Page 7-39 to 7-43)		U.L. Bench Top Rise Code 1029 (pg 7-3)	
								Fig	A	B	Mfd	Min Volt	Cap Catalog Number	Dry or Oil	Total Weight (lbs)	Part Number		Max Dist To Lamp (ft)
35/39W Lamp, ANSI Code M130 (Pulse Start)																		
120	71A5005-500DP	HX-HPF	55	1.1	230	3	F	6	.9	1.8	28	120	7C280M12RA	D	2.2	LI533-H4	15	A
120/277	71A5081-500D 71A5081-001D	HX-HPF	56	.9/.4	230	3/1	K	1	.8	2.1	5	280	7C050L30RA	D	3.5	LI533-H4	15	B/A
277	71A5037-500DP	R-HPF	48	.6	277	2	G	9	.8	1.9	5	280	7C050L30RA	D	1.8	LI533-H4	7	A
277	71A5037-500DBP	R-HPF	48	.6	277	2	H	9	1.0	2.7	5	280	7C050L30RA	D	1.9	Integral Ignitor	2	A
50W Lamp, ANSI Code M110 or M148 (Pulse Start)																		
120	71A5105-500DP	HX-PFC	67	2.0	275	3	F	6	1.1	1.3	28	120	7C280M12RA	D	2.3	LI533-H4	15	A
120/277	71A5181-001D	HX-HPF	67	1.2/.5	254	3/2	K	14	1.2	2.8	6	280	7C060L30RA	D	4.8	LI533-H4	10	A/A
120/208/ 240/277	71A5191-500D 71A5191-001D	HX-HPF	67	1.2/.68/ .59/.51	254	3/3/ 2/2	K	14	1.2	2.8	6	280	7C060L30RA	D	4.3	LI533-H4	10	A/A A/A
277	71A5137-510DP	R-HPF	62	.6	277	2	G	9	1.1	2.2	5	280	7C050L30RA	D	2.2	LI533-H4	2	A
277	71A5137-500DBP	R-HPF	62	.6	277	2	H	9	1.1	2.6	5	280	7C050L30RA	D	2.2	Integral Ignitor	2	A

† Ordering information:

Replacement/retrofit ballast kits – indicated by bold type and -001D or -001 suffix. Refer to pages 7-4 to 7-9 for more information on replacement kits.

Original equipment ballasts – typically ordered with capacitor (as shown).
 -500D includes core & coil with dry-film capacitor.
 -500 includes core & coil with oil-filled capacitor (required for higher wattage ballasts).

May also be available with welded bracket, and/or without capacitor:
 -510D includes core & coil with welded bracket and dry-film capacitor.
 -510 includes core & coil with welded bracket and oil-filled capacitor.
 -600 core & coil only (no capacitor).
 -610 core & coil with welded bracket (no capacitor).

†† Each ballast requiring an ignitor is furnished standard with a short-range ignitor model shown for use within fixtures. Long-range ignitors are available separately if required. See pages 7-39 to 7-43 for additional information.

• **Maximum Input Current** – For HX and R circuits, value is the highest of starting, operating or open circuit current. For CWA, SCWA and CWI circuits, value is the operating current.

NOM Certified ballast available for Mexican market. Add "ML" to suffix (example -500DML). Ballast is branded Philips.

☼ Canadian replacement/retrofit ballast kit indicated by bold type. Refer to page 7-8.
 ♦ Includes auto-reset thermal protection.

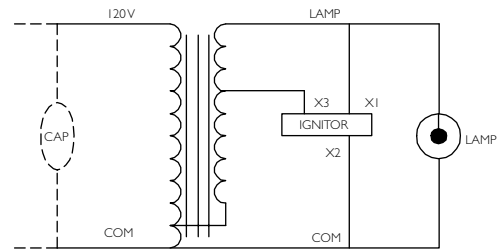

Fig. F

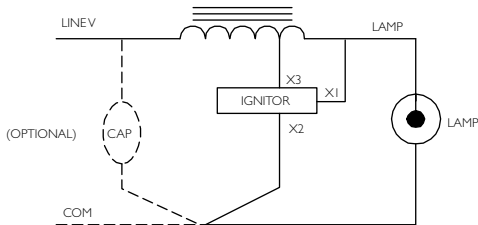

Fig. G

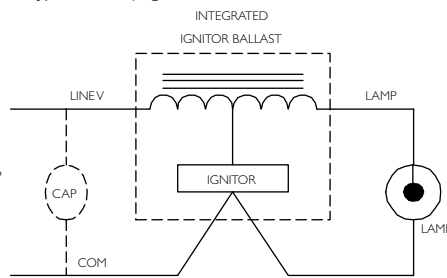

Fig. H

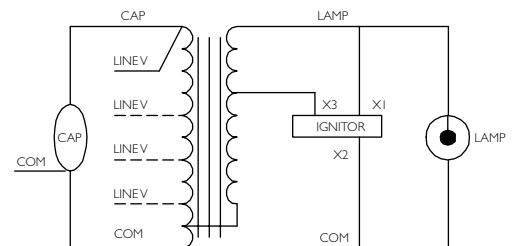

Fig. K

Refer to page 7-12 for dimensions.

60 Hz Core & Coil Ballasts

Metal Halide



Input Volts	Catalog† Number	Circuit Type	Input Watts	Max Input Current	Nom Open Circuit Voltage	Fuse Rating (Amps)	Wiring Dia	Dimensions			Non-PCB Capacitor (Page 7-37 & 7-38)				Total Weight (lbs)	Ignitor †† (Page 7-39 to 7-43)		U.L. Bench Top Rise Code 1029 (pg 7-3)	
								Fig	A	B	Mfd	Min Volt	Cap Catalog Number	Dry or Oil		Part Number	Max Dist To Lamp (ft)		
70W Lamp, ANSI Code M98 (Medium Base) or M143 (Pulse Start)																			
120	71A5205-500DP	HX-PFC	94	1.4	255	4	F	6	1.6	2.7	36	120	7C360M12RA	D	3.7	LI533-H4	10	B	
NOM	127/220	71A52H2-500DML	HX-HPF	90	1.9/9	255	4/2	K	1	1.5	2.8	8	280	7C080L30RA	D	5.0	LI533-H4	15	A/A
NOM	120/208/240/277	71A5292-500D 71A5292-001D	HX-HPF	90	1.7/1.0/.8/7	255	4/3/2/2	K	14	1.5	2.9	8	280	7C080L30RA	D	5.0	LI533-H4	15	A/A/A/A
+	120/277/347	71A52A2-500D 71A52A2-001D	HX-HPF	90	1.9/.8/7	255	4/2/2	K	1	1.5	2.8	8	280	7C080L30RA	D	5.0	LI533-H4	15	A/A/A
120	71A5237-500DP	R-HPF	85	.8	277	2	G	9	1.6	2.7	8	280	7C080L30RA	D	2.9	LI533-H4	10	A	
120	71A5237-500DBP	R-HPF	85	.8	277	2	H	9	1.5	2.9	8	280	7C080L30RA	D	2.9	Integral Ignitor	2	A	
70W Lamp, ANSI Code M139 (Philips CDM70/T6, CDM70/TD) (Pulse Start)																			
120/277/347	71A52A1-500D	HX-HPF	94	1.9/.8/65	255	4/2/2	K	1	1.5	2.8	8	280	7C080L30RA	D	5.0	LI533-H4	5	A/A/A	
70W Double-ended Lamp, ANSI Code M85 (OSI Briteline/HQI, GE MQI ARC70/TD, Philips MHN70/TD) (Pulse Start)																			
120/277	71A5280-510D	HX-HPF	94	1.6/7	245	4/2	K	1	1.5	2.7	8	280	7C080L30RA	D	5.5	LI522-H5	30	A/A	

WELDED BRACKET DIMENSIONS

Ballast Dimensions Fig	L	W	M	S
1, 6	5.1	1.00	4.50	0.25
9	4.0	0.75	3.50	0.28

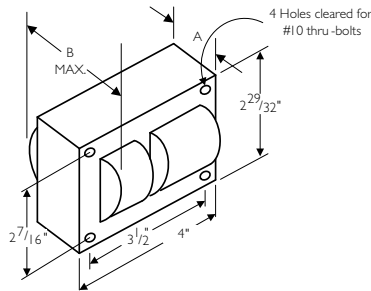
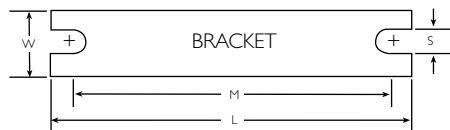

Fig. 14
(3" x 4" Core)

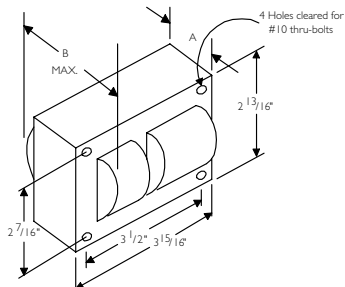

Fig. 1
(3" x 4" Core)

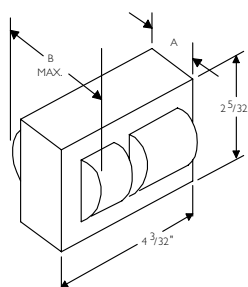

Fig. 6
(2" x 4" Core)

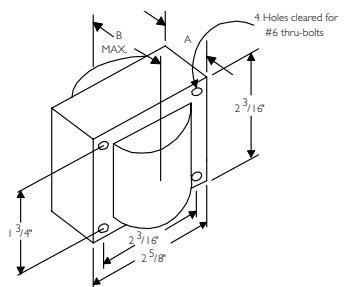

Fig. 9
(2⁵/₈" x 2³/₁₆" Reactor Core)

60 Hz Core & Coil Ballasts

Metal Halide



Input Volts	Catalog† Number	Circuit Type	Input Watts	Max Input Current	Nom Open Circuit Voltage	Fuse Rating (Amps)	Wiring Dia	Dimensions			Non-PCB Capacitor (Page 7-37 & 7-38)				Total Weight (lbs)	Ignitor †† (Page 7-39 to 7-43)		U.L. Bench Top Rise Code 1029 (pg 7-3)	
								Fig	A	B	Mfd	Min Volt	Cap Catalog Number	Dry or Oil		Part Number	Max Dist To Lamp (ft)		
100W Lamp, ANSI Code M90 or M140 (Pulse Start)																			
127/220	71A53HO-500DML	HX-HPF	129	2.2/1.3	280	5/3	K	1	1.7	2.9	12	280	7C120M30RA	D	5.5	LI533-H4	20	A/B	NOM
120/208 240/277	71A5390-500D 71A5390-001D	HX-HPF	129	2.5/1.5/ 1.3/1.1	260	10/5/ 5/4	K	14	1.5	3.1	12	280	7C120M30RA	D	5.5	LI533-H4	20	B/B/ A/A	NOM
120/ 277/347	71A53AO-500D 71A53AO-001D	HX-HPF	129	2.3/ 1.0/0.8	255	6/ 3/2	K	14	1.7	3.3	12	280	7C120M30RA	D	5.9	LI533-H4	25	B/ B/B	☀
480/ 120T	71A5340-500DT	HX-HPF	132	.6	260	2	K	1	1.7	2.9	10	300	7C100M30RA	D	5.5	LI533-H4	25	C	
120/277	71A5383-500D	SUPER CWA	128	1.1/5	222	3/2	M	1	1.6	2.8	10	330	7C100M40R	D	5.5	LI533-H4	2	C/C	
277	71A5337-500DP	R-HPF	118	1.1	277	3	G	9	1.7	2.8	10	280	7C100M30RA	D	3.2	LI533-H4	2	A	✦
277	71A5337-510DBP	R-HPF	118	1.1	277	3	H	9	1.8	3.1	10	280	7C100M30RA	D	3.2	Integral Ignitor	2	A	✦

† Ordering information:

Replacement/retrofit ballast kits – indicated by bold type and -001D or -001 suffix. Refer to pages 7-4 to 7-9 for more information on replacement kits.

Original equipment ballasts – typically ordered with capacitor (as shown).
 -500D includes core & coil with dry-film capacitor.
 -500 includes core & coil with oil-filled capacitor (required for higher wattage ballasts).

May also be available with welded bracket, and/or without capacitor:
 -510D includes core & coil with welded bracket and dry-film capacitor.
 -510 includes core & coil with welded bracket and oil-filled capacitor.
 -600 core & coil only (no capacitor).
 -610 core & coil with welded bracket (no capacitor).

†† Each ballast requiring an ignitor is furnished standard with a short-range ignitor model shown for use within fixtures. Long-range ignitors are available separately if required. See pages 7-39 to 7-43 for additional information.

• Maximum Input Current – For HX and R circuits, value is the highest of starting, operating or open circuit current. For CWA, SCWA and CWI circuits, value is the operating current.

NOM Certified ballast available for Mexican market. Add "ML" to suffix (example -500DML). Ballast is branded Philips.

☀ Canadian replacement/retrofit ballast kit indicated by bold type. Refer to page 7-8.

✦ Includes auto-reset thermal protection.

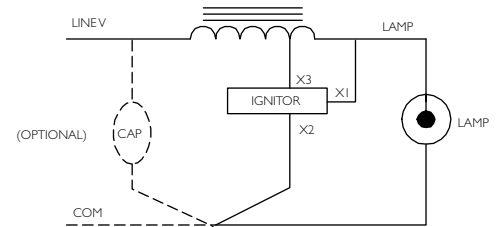

Fig. G

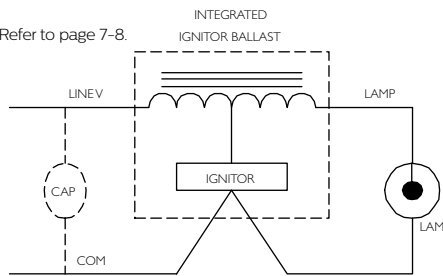

Fig. H

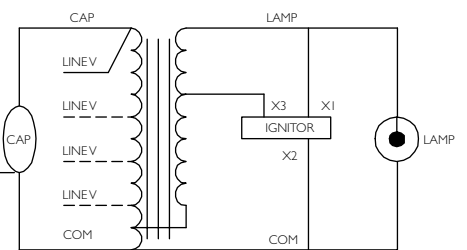

Fig. K

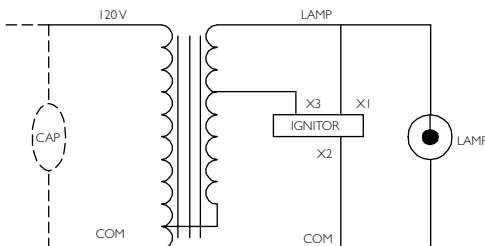

Fig. F

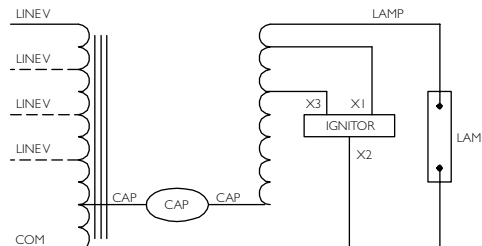

Fig. L

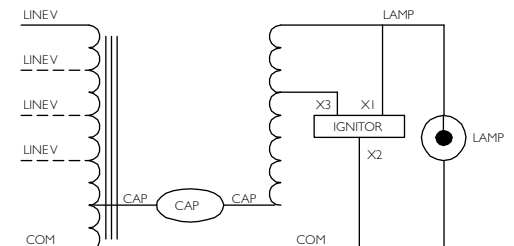

Fig. M

60 Hz Core & Coil Ballasts

Metal Halide



Input Volts	Catalog† Number	Circuit Type	Input Watts	Max* Input Current	Nom Open Circuit Voltage	Fuse Rating (Amps)	Wiring Dia	Dimensions			Non-PCB Capacitor (Page 7-37 & 7-38)				Total Weight (lbs)	Ignitor †† (Page 7-39 to 7-43)		U.L. Bench Top Rise Code 1029 (pg 7-3)	
								Fig	A	B	Mfd	Min Volt	Cap Catalog Number	Dry or Oil		Part Number	Max Dist To Lamp (ft)		
150W Lamp, ANSI Code M102 or M142 (Pulse Start)																			
NOM 120/208/240/277	71A5492-500D 71A5492-001D	HX-HPF	185	3.5/2.1/ 1.7/1.5	250	10/5/ 5/4	K	14	2.3	3.9	16	280	7C160M30RA	D	7.0	LI533-H4	10	C/B/ B/A	
480/ 120T	71A5442-500DT	HX-HPF	185	.9	270	3	K	1	2.8	4.0	16	280	7C160M30RA	D	9.0	LI533-H4	10	B	
120/ 277/347	71A54A2-500D	HX-HPF	185	3.7/ 1.6/1.3	265	10/ 4/3	K	1	2.3	3.9	16	280	7C160M30RA	D	7.0	LI533-H4	10	E/ E/E	
480/ 120T	71A5443-520DT	Super CWA	185	0.4	215	5	M	1	2.4	3.8	16	300	7C160M30RA	D	7.5	LI501-J4	5	C	
120/208/240/277	71A5493-500D	Super CWA	190	1.7/.95/ .85/.75	210	5/2.5/ 2/2	M	14	2.4	3.9	16	300	7C160M30RA	D	8.3	LI501-J4	5	D/C/ D/C	
120/ 277/347	71A54A3-500D	Super CWA	189	1.7/ .8/.7	187	5/ 2/2	L	1	2.7	4.0	22	240	7C220M24RA	D	9.0	LI501-J4	15	C/ B/A	
✦ 277	71A5437-500DBP	Linear Reactor HPF	173	1.5	277	4	H	9	2.5	4.0	14	280	7C140M30RA	D	4.2	Integral Ignitor	2	B	
150W Lamp, ANSI Code M81 (OSI Briteline/HQI, GE Arcstream MQI, Philips MHN-TD) (Pulse Start)																			
NOM 120/208/ 240/277	71A5490-500D	HX-HPF	185	3.6/2.1/ 1.8/1.6	240	9/6/ 5/4	K	1	2.5	3.8	16	300	7C160M30RA	D	8.5	LI522-H5	20	C/C/ A/A	

WELDED BRACKET DIMENSIONS

Ballast Dimensions Fig	L	W	M	S
1	5.1	1.00	4.50	0.25
9	4.0	0.75	3.50	0.28

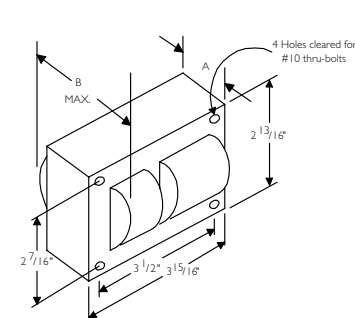
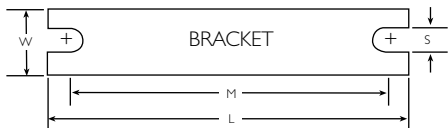

Fig 1
(3" x 4" Core)

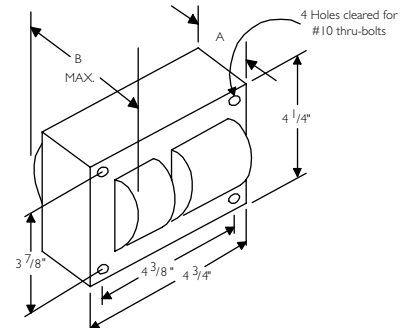

Fig 2
(4 1/4" x 4 3/4" Core)

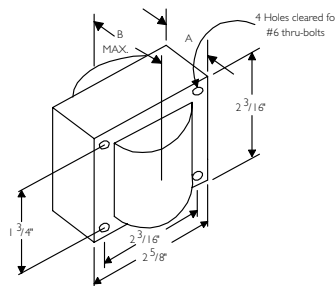

Fig 9
(2 5/8" x 2 3/16" Reactor Core)

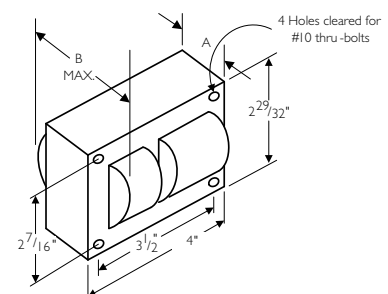

Fig 14
(3" x 4" Core)

60 Hz Core & Coil Ballasts

Metal Halide



Input Volts	Catalog † Number	Circuit Type	Input Watts	Max* Input Current	Nom Open Circuit Voltage	Fuse Rating (Amps)	Wiring Dia	Dimensions			Non-PCB Capacitor (Page 7-37 & 7-38)				Total Weight (lbs)	Ignitor †† (Page 7-39 to 7-43)		U.L. Bench Top Rise Code 1029 (pg 7-3)	
								Fig	A	B	Mfd	Min Volt	Cap Catalog Number	Dry or Oil		Part Number	Max Dist To Lamp (ft)		
175W Lamp, ANSI Code M57 or 150 Watt Lamp, ANSI Code M107 or 145W lamp, ANSI Code C192 (Philips AllStart)**																			
480	71A5540-001D	CWA	210	0.5	305	2	A	1	2.4	4.0	10	400	7C100M40R	D	8.5	NA	NA	D	
127/220	71A55H0-500DML	CWA	210	1.8/1.1	305	5/3	A	14	2.4	3.9	10	400	7C100M40R	D	8.0	NA	NA	B/B	NOM
120/208 240/277	71A5590-500D	CWA	210	1.8/1.1/ .9/.8	305	5/3/ 3/2	A	14	2.5	4.0	10	400	7C100M40R	D	7.0	NA	NA	C/D/ D/D	NOM
120/208 240/277	71A5570-001D	CWA	210	1.8/1.1/ .9/.8	305	5/3/ 3/2	A	14	2.5	4.0	10	400	7C100M40R	D	7.5	NA	NA	C/D/ D/D	
120/ 277/347	71A55A0-500D 71A55A0-001D	CWA	213	1.9/ .8/.7	305	5/ 3/2	A	14	2.4	4.0	10	400	7C100M40R	D	7.0	NA	NA	C/ C/D	☀
175W Lamp, ANSI Code M137 or M152 (Pulse Start) or 145W Lamp, ANSI Code 192 (Philips AllStart)**																			
480/120T	71A5543-500DTEE	Super CWA	198	0.45	278	2	M		3.1	4.2	11	370	7C110M40	D	10.7	LI533-H5	2	A	ⓔ
120/208 240/277	71A5593-500DEE	Super CWA	198	1.8/1.1/ .9/.8	285	5/3/ 3/2	M		3.2	4.4	11	370	7C110M40	D	10.8	LI533-H5	2	A/A/ A/A	ⓔ
120/208 240/277	71A5593-500DML 71A5593-001D	Super CWA	208	1.9/1.1/ .9/.8	275	5/3/ 3/3	M		2.3	3.5	11	370	7C110M40	D	7.0	LI533-H4	2	C/C/ C/C	NOM
120/ 277/347	71A55A3-500D	Super CWA	208	1.9/ .9/.7	275	5/ 3/2	M		2.3	3.5	11	370	7C110M40	D	7.0	LI533-H4	2	C/ C/C	☀

† Ordering information:

Replacement/retrofit ballast kits – indicated by bold type and -001D or -001 suffix. Refer to pages 7-4 to 7-9 for more information on replacement kits.

Original equipment ballasts – typically ordered with capacitor (as shown).

- 500D includes core & coil with dry-film capacitor.
- 500 includes core & coil with oil-filled capacitor (required for higher wattage ballasts).

May also be available with welded bracket, and/or without capacitor:

- 510D includes core & coil with welded bracket and dry-film capacitor.
- 510 includes core & coil with welded bracket and oil-filled capacitor.
- 600 core & coil only (no capacitor).
- 610 core & coil with welded bracket (no capacitor).

†† Each ballast requiring an ignitor is furnished standard with a short-range ignitor model shown for use within fixtures. Long-range ignitors are available separately if required. See pages 7-39 to 7-43 for additional information.

• **Maximum Input Current** – For HX and R circuits, value is the highest of starting, operating or open circuit current. For CWA, SCWA and CWI circuits, value is the operating current.

** The 145 Watt Lamp, ANSI Code C192, is an energy saving, screw in replacement lamp for the M57 or M152 lamps that may reduce input watts up to 15% on existing 175W ballasts.

NOM Certified ballast available for Mexican market. Add "ML" to suffix (example -500DML). Ballast is branded Philips.

☀ Canadian replacement/retrofit ballast kit indicated by bold type. Refer to page 7-8.

⚡ Includes auto-reset thermal protection.

◆ Compact 3 x 4 core design.

ⓔ Meets EISA 88% efficiency requirements.

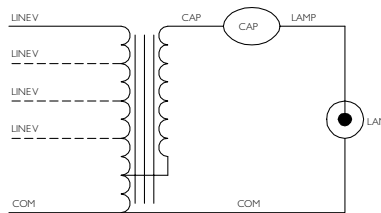

Fig. A

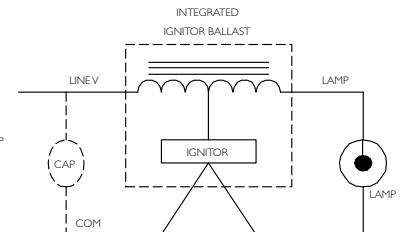

Fig. H

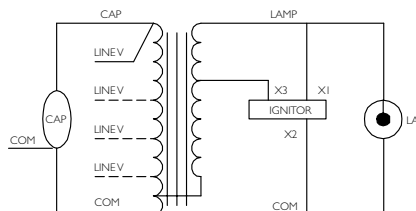

Fig. K

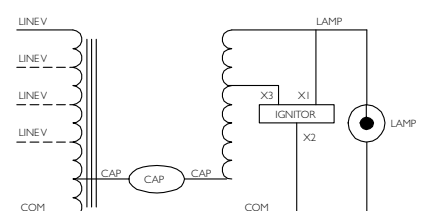

Fig. M

60 Hz Core & Coil Ballasts

Metal Halide



Input Volts	Catalog [†] Number	Circuit Type	Input Watts	Max [*] Input Current	Nom Open Circuit Voltage	Fuse Rating (Amps)	Wiring Dia	Dimensions			Non-PCB Capacitor (Page 7-37 & 7-38)				Total Weight (lbs)	Ignitor ^{††} (Page 7-39 to 7-43)		U.L. Bench Top Rise Code 1029 (pg 7-3)	
								Fig	A	B	Mfd	Min Volt	Cap Catalog Number	Dry or Oil		Part Number	Max Dist To Lamp (ft)		
200W Lamp, ANSI Code M136 (Pulse Start)																			
480/120T	71A5642-500DTEE	Super CWA	227	0.6	240	2	M	1	2.9	4.2	15	330	7C150M33	D	8.7	LI533-H4	2	A	
120/208/240/277	71A5692-500DEE	Super CWA	227	2.2/1.3/1.1/1.0	240	6/4/3/3	M	1	3.0	4.2	15	330	7C150M33	D	8.8	LI533-H4	2	A/A/A/A/A	
120/208/240/277	71A5692-001D	Super CWA	232	2.0/1.2/1.0/0.9	240	6/4/3/3	M	1	2.5	3.6	15	330	7C150M33	D	8.0	LI533-H4	2	A/B/A/A/A	
120/277/347	71A56A2-500D	Super CWA	232	2.1/0.9/0.7	235	6/3/2	M	1	2.5	3.6	15	330	7C150M33	D	8.0	LI533-H4	2	C/A/A	

- ⓔ
- ◆
- ⓔ
- ◆
- ◆
- ◆

WELDED BRACKET DIMENSIONS

Ballast Dimensions Fig	L	W	M	S
1	5.1	1.00	4.50	0.25
2, 10	6.5	1.25	5.75	0.28

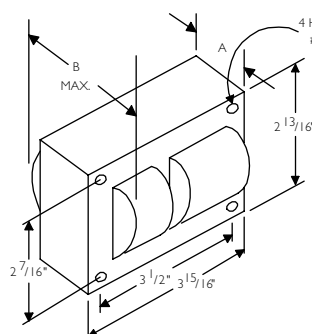
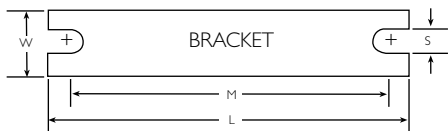

Fig. 1
(3" x 4" Core)

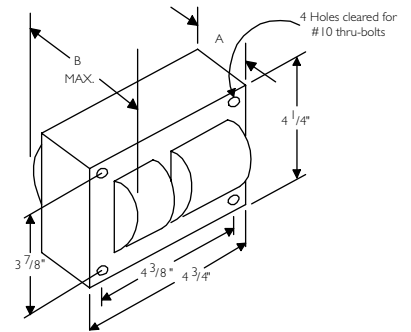

Fig. 2
(4 1/4" x 4 3/4" Core)

60 Hz Core & Coil Ballasts

Metal Halide



Input Volts	Catalog [†] Number	Circuit Type	Input Watts	Max [*] Input Current	Nom Open Circuit Voltage	Fuse Rating (Amps)	Wiring Dia	Dimensions			Non-PCB Capacitor (Page 7-37 & 7-38)				Total Weight (lbs)	Ignitor †† (Page 7-39 to 7-43)		U.L. Bench Top Rise Code 1029 (pg 7-3)	
								Fig	A	B	Mfd	Min Volt	Cap Catalog Number	Dry or Oil		Part Number	Max Dist To Lamp (ft)		
250W Lamp, ANSI Code M58 or 205W Lamp, ANSI Code C184 (Philips AllStart)***																			
120/208/240/277/480	71A5750-001D	CWA	290	2.6/1.5/1.4/1.1/.7	315	8/5/5/3/2	A	2	1.6	3.1	15	400	7C150P40R	D	10.0	-	-	A/A/B/A/B	
120/208/240/277	71A5770-001D	CWA	298	2.5/1.4/1.3/1.1	300	8/5/5/3	A	2	1.5	3.2	15	400	7C150P40R	D	10.0	-	-	B/B/B/B	
120/208/240/277	71A5790-500DMLA	CWA	295	2.5/1.4/1.3/1.1	300	8/5/5/3	A	2	1.5	3.2	15	400	7C150P40R	D	9.1	-	-	A/A/B/A	
120/208/240/277	71A5790-500DA	CWA	288	2.5/1.5/1.3/1.1	290	8/5/5/3	A	2	1.5	3.5	15	400	7C150P40R	D	9.1	-	-	B/B/B/B	
120/277/347	71A57A0-600A 71A57A0-001D	CWA	295	2.5/1.1/1.9	315	8/3/3	A	2	1.7	3.6	15	400	7C150P40R	D	10.0	-	-	A/A/A/A	
127/220	71A57H0-500DMLA	CWA	295	2.6/1.5	300	8/5	A	2	1.7	3.2	15	400	7C150P40R	D	10.0	-	-	A/A	
480	71A5741-001D	CWA	298	.7	300	2	A	1	3.0	4.2	15	400	7C150P40R	D	9.0	-	-	H	
120/208/240/277	71A5771-001D	CWA	294	2.6/1.5/1.3/1.1	300	8/5/5/3	A	1	3.0	4.2	15	400	7C150P40R	D	9.0	-	-	C/C/D/D	
120/208/240/277	71A5791-500D	CWA	294	2.6/1.5/1.3/1.1	300	8/5/5/3	A	1	3.0	4.2	15	400	7C150P40R	D	9.0	-	-	C/C/D/D	

† Ordering information:

Replacement/retrofit ballast kits – indicated by bold type and -001D or -001 suffix. Refer to pages 7-4 to 7-9 for more information on replacement kits.

Original equipment ballasts – typically ordered with capacitor (as shown).

- 500D includes core & coil with dry-film capacitor.
- 500 includes core & coil with oil-filled capacitor (required for higher wattage ballasts).

May also be available with welded bracket, and/or without capacitor:

- 510D includes core & coil with welded bracket and dry-film capacitor.
- 510 includes core & coil with welded bracket and oil-filled capacitor.
- 600 core & coil only (no capacitor).
- 610 core & coil with welded bracket (no capacitor).

†† Each ballast requiring an ignitor is furnished standard with a short-range ignitor model shown for use within fixtures. Long-range ignitors are available separately if required. See pages 7-39 to 7-43 for additional information.

• **Maximum Input Current** – For HX and R circuits, value is the highest of starting, operating or open circuit current. For CWA, SCWA and CWI circuits, value is the operating current.

** The 205 Watt Lamp, ANSI Code C184 is an energy saving, screw in replacement lamp for the M58 or M138 and M153 PS lamps that may reduce input watts up to 18% on existing ballasts. This lamp requires the use of the dedicated AS205W ballast family in order to achieve the 88% efficiency requirement of EISA in new fixtures.

NOM Certified ballast available for Mexican market. Add "ML" to suffix (example -500DML). Ballast is branded Philips.

Canadian replacement/retrofit ballast kit indicated by bold type. Refer to page 7-8.

- ❖ Includes auto-reset thermal protection.
- ◆ Compact 3 x 4 core design.

ⓔ Meets EISA 88% efficiency requirements.

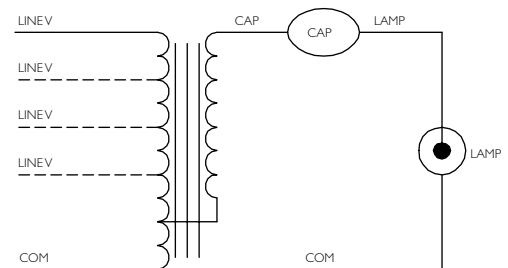

Fig. A

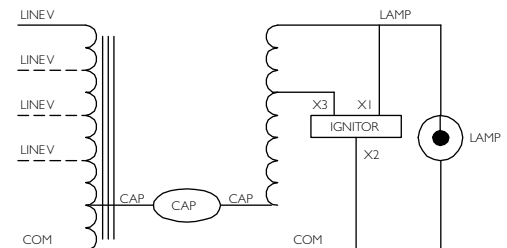

Fig. M

60 Hz Core & Coil Ballasts

Metal Halide



	Input Volts	Catalog† Number	Circuit Type	Input Watts	Max' Input Current	Nom Open Circuit Voltage	Fuse Rating (Amps)	Wiring Dia	Dimensions			Non-PCB Capacitor (Page 7-37 & 7-38)				Total Weight (lbs)	Ignitor †† (Page 7-39 to 7-43)		U.L. Bench Top Rise Code 1029 (pg 7-3)
									Fig	A	B	Mfd	Min Volt	Cap Catalog Number	Dry or Oil		Part Number	Max Dist To Lamp (ft)	
250W Lamp, ANSI Code M138 or M153 (Pulse Start) or 205W Lamp, ANSI Code C184 (Philips AllStart)**																			
ⓔ	480/120T	71A5742-500DTEE	Super CWA	283	0.7	290	2	M	2	2.2	4.0	17	340	7C170P40	D	11.0	LI533-H4	2	A
ⓔ	120/208/240/277/480	71A5752-500DAEE 71A5752-001D	Super CWA	284	2.4/1.4/1.2/1.1/0.6	280	8/5/5/3/2	M	2	2.2	4.0	17	340	7C170P40	D	11.5	LI533-H4	2	A/A/A/A
ⓔ	120/208/240/277	71A5792-500DEE	Super CWA	284	2.6/1.5/1.3/1.1	280	8/5/5/3	M	2	1.7	3.4	17	340	7C170P40	D	9.5	LI533-H4	2	A/A/A/A
ⓔ	120/208/240/277	71A5792-500DXEE	Super CWA	277	2.52/1.44/1.26/1.10	275	8/5/5/3	M	2	2.15	4.05	17	340	7C170P40	D	14.0	LI533-H5	2	A/A/A/A
	120/208/240/277	71A5792-001D	Super CWA	291	2.5/1.4/1.3/1.1	275	8/5/5/3	M	2	1.5	3.1	17	340	7C170P40	D	9.5	LI533-H4	5	A/A/A/B
NOM	120/208/240/277	71A5792-500DMLA	Super CWA	291	2.5/1.5/1.3/1.1	275	8/5/5/3	M	2	1.5	3.1	17	340	7C170P40	D	9.5	LI533-H4	2	A/A/A/B
☼	120/277/347	71A57A2-500D	Super CWA	290	2.5/1.1/0.9	274	8/3/3	M	2	1.5	3.4	17	340	7C170P40	D	9.5	LI533-H4	5	A/A/A

WELDED BRACKET DIMENSIONS

Ballast Dimensions Fig	L	W	M	S
1	5.1	1.00	4.50	0.25
2, 10	6.5	1.25	5.75	0.28

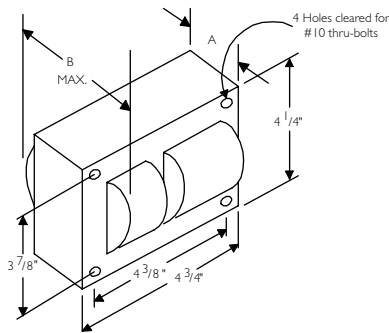
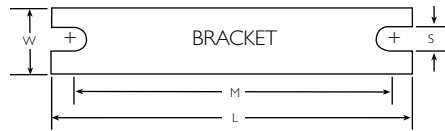

Fig. 2
(4 1/4" x 4 3/4" Core)

60 Hz Core & Coil Ballasts

Metal Halide



Input Volts	Catalog† Number	Circuit Type	Input Watts	Max* Input Current	Nom Open Circuit Voltage	Fuse Rating (Amps)	Wiring Dia	Dimensions			Non-PCB Capacitor (Page 7-37 & 7-38)				Total Weight (lbs)	Ignitor †† (Page 7-39 to 7-43)		U.L. Bench Top Rise Code 1029 (pg 7-3)	
											Mfd	Min Volt	Cap Catalog Number	Dry or Oil		Part Number	Max Dist To Lamp (ft)		
								Fig	A	B									
320W Lamp, ANSI Code M132 or M154 or M170 (Pulse Start)																			
480/120T	71A5842-500DTAEE	Super CWA	363	0.8	285	3	M	2	2.2	4.1	21	345	7C210P34R	D	11.0	LI533-H4	2	B	ⓔ
120/208/240/277/480	71A5852-500DAEE	Super CWA	363	3.3/1.9/1.7/1.4/0.8	290	10/7/5/5/5	M	2	2.2	4.1	21	345	7C210P34R	D	11.8	LI533-H4	2	A/B/A/A/A	ⓔ
120/208/240/277	71A5892-500DAEE	Super CWA	363	3.3/1.9/1.7/1.4	255	8/6/5/3	M	2	2.1	4.2	21	345	7C210P34R	D	11.0	LI533-H4	2	A/A/A/A	ⓔ
480/120T	71A5842-001DT	Super CWA	368	0.8	275	3	M	2	1.8	3.7	21	345	7C210P34R	D	11.0	LI533-H4	2	D	
120/208/240/277	71A5892-500DMLA 71A5892-001D	Super CWA	363	3.3/1.9/1.7/1.4	250	8/6/5/3	M	2	1.8	3.9	21	345	7C210P34R	D	11.0	LI533-H4	2	B/B/B/B	NOM
120/277/347	71A58A2-500DA	Super CWA	368	3.3/1.4/1.1	280	8/4/3	M	2	1.8	3.7	21	345	7C210P34R	D	10.0	LI533-H4	2	C/C/C	🇨🇦

† Ordering information:

Replacement/retrofit ballast kits – indicated by bold type and -001D or -001 suffix. Refer to pages 7-4 to 7-9 for more information on replacement kits.

Original equipment ballasts – typically ordered with capacitor (as shown).
 -500D includes core & coil with dry-film capacitor.
 -500 includes core & coil with oil-filled capacitor (required for higher wattage ballasts).

May also be available with welded bracket, and/or without capacitor:

- 510D includes core & coil with welded bracket and dry-film capacitor.
- 510 includes core & coil with welded bracket and oil-filled capacitor.
- 600 core & coil only (no capacitor).
- 610 core & coil with welded bracket (no capacitor).

†† Each ballast requiring an ignitor is furnished standard with a short-range ignitor model shown for use within fixtures. Long-range ignitors are available separately if required. See pages 7-39 to 7-43 for additional information.

• **Maximum Input Current** – For HX and R circuits, value is the highest of starting, operating or open circuit current. For CWA, SCWA and CWI circuits, value is the operating current.

** The 330 Watt Lamp, ANSI Code C185 is an energy saving, screw in replacement lamp for the M59 or M135 and M155 PS lamps that may reduce input watts up to 18% on existing ballasts.

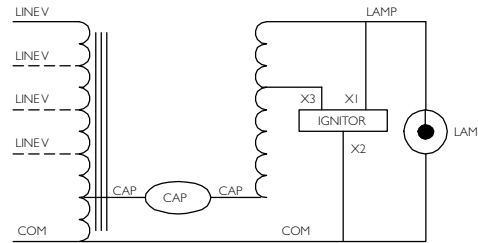

Fig. M

NOM Certified ballast available for Mexican market. Add "ML" to suffix (example: -500DML). Ballasts are branded Philips.

🇨🇦 Canadian replacement/retrofit ballast kit indicated by bold type. Refer to page 7-8.

❖ Includes auto-reset thermal protection.

◆ Compact 3 x 4 core design.

ⓔ Meets EISA 88% efficiency requirements.

60 Hz Core & Coil Ballasts

Metal Halide



	Input Volts	Catalog † Number	Circuit Type	Input Watts	Max Input Current	Nom Open Circuit Voltage	Fuse Rating (Amps)	Wiring Dia	Dimensions			Non-PCB Capacitor (Page 7-37 & 7-38)				Total Weight (lbs)	Ignitor †† (Page 7-39 to 7-43)		U.L. Bench Top Rise Code 1029 (pg 7-3)
												Mfd	Min Volt	Cap Catalog Number	Dry or Oil		Part Number	Max Dist To Lamp (ft)	
									Fig	A	B								
350W Lamp, ANSI Code M131 or M171 (Pulse Start)																			
Ⓔ	480/120T	71A5943-500DTAEE	Super CWA	397	0.9	280	3	M	2	2.2	4.1	22.5	345	7C225P40	D	11.6	LI533-H4	2	B
Ⓔ	120/208/240/277	71A5993-500DAEE	Super CWA	397	3.4/2.0/1.7/1.5	280	10/7/5/5	M	2	2.2	4.1	22.5	345	7C225P40	D	11.6	LI533-H4	2	A/B/A/A
NOM	120/208/240/277	71A5993-500DMLA 71A5993-001D	Super CWA	400	3.4/2.0/1.7/1.5	270	10/7/5/5	M	2	1.8	3.7	22.5	345	7C225P40	D	11.0	LI533-H4	2	D/C/C/C/C
	120/277/347	71A59A3-500DA	Super CWA	400	3.4/1.5/1.2	280	10/5/3	M	2	1.8	3.7	22.5	345	7C225P40	D	10.5	LI533-H4	2	D/C/C
400W Lamp, ANSI Code M59, or 360W Lamp, ANSI Code M165, or 330W Lamp, ANSI Code C185 (Philips AllStart)**																			
NOM	480	71A6041-500DMLA	CWA	462	1.0	300	3	A	2	2.2	4.0	24	400	7C240P40R	D	13.0	-	-	E
	480/120T	71A6041-001D	CWA	462	1.0	300	3	A	2	2.2	4.0	24	400	7C240P40R	D	12.0	-	-	E
	120/208/240/277/480	71A6051-001D	CWA	455	4.1/2.3/2.0/1.7/1.0	300	10/7/5/5/3	A	2	2.4	4.4	24	400	7C240P40R	D	13.1	-	-	D/C/D/C/D
	120/208/240/277	71A6071-001D	CWA	458	4.0/2.3/2.0/1.7	300	10/7/5/5	A	2	2.1	4.0	24	400	7C240P40R	D	12.0	-	-	D/E/D/E
NOM	120/208/240/277	71A6091-500DA 71A6091-500DMLA	CWA	458	4.0/2.3/2.0/1.7	300	10/7/5/5	A	2	2.1	4.0	24	400	7C240P40R	D	12.0	-	-	D/E/D/E
🍁	120/277/347	71A60A1-500DA 71A60A1-001D	CWA	460	4.0/1.7/1.4	295	10/5/4	A	2	2.1	4.1	24	400	7C240P40R	D	12.0	-	-	D/D/D
NOM	127/220	71A60HI-500DMLA	CWA	454	3.9/2.2	300	10/7	A	2	2.2	4.1	24	400	7C240P40R	D	11.5	-	-	F/F
	120/208/240	71A60E6-500	CWI	465	4.2/2.5/2.1	320	10/7/5	P	2	2.4	4.0	20	425	MD2006-100	O	14.0	-	-	E/D/D

WELDED BRACKET DIMENSIONS

Ballast Dimensions Fig	L	W	M	S
2, 10	6.5	1.25	5.75	0.28

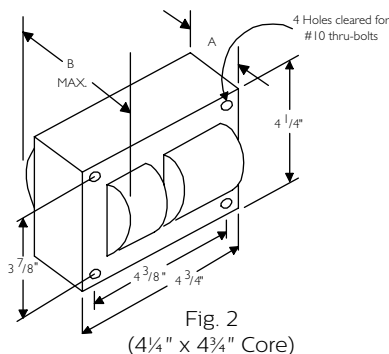
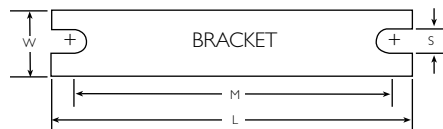

60 Hz Core & Coil Ballasts

Metal Halide



Input Volts	Catalog† Number	Circuit Type	Input Watts	Max Input Current	Nom Open Circuit Voltage	Fuse Rating (Amps)	Wiring Dia	Dimensions			Non-PCB Capacitor (Page 7-37 & 7-38)				Total Weight (lbs)	Ignitor †† (Page 7-39 to 7-43)		U.L. Bench Top Rise Code 1029 (pg 7-3)	
								Fig	A	B	Mfd	Min Volt	Cap Catalog Number	Dry or Oil		Part Number	Max Dist To Lamp (ft)		
400W Lamp, ANSI Code M135 or M155 or M172 (Pulse Start), or 330W Lamp, ANSI Code C185 (Philips AllStart)**																			
480/120T	71A6042-500DTAEE	Super CWA	445	0.9	260	3	M	2	2.1	4.1	26	330	7C260P33R	D	12.0	LI533-H4	2	D	ⓔ
120/208/240/277/480	71A6052-500DAEE 71A6052-001D	Super CWA	454	3.8/2.2/1.9/1.7/1.0	275	10/7/5/5/3	M	2	2.2	4.3	26	330	7C260P33R	D	12.5	LI533-H4	2	B/D/D/B/D	ⓔ
120/208/240/277	71A6092-500DAEE	Super CWA	452	3.8/2.2/1.9/1.7	275	10/7/5/5	M	2	2.2	4.1	26	330	7C260P33R	D	12.2	LI533-H4	2	D/D/D/D	ⓔ
480/120T	71A6042-001D	Super CWA	452	1.0	270	3	M	2	2.1	3.9	26	330	7C260P33R	D	14.5	LI533-H4	2	D	ⓔ
120/208/240/277	71A6092-500DMLA 71A6092-001D	Super CWA	452	3.8/2.2/1.9/1.7	270	10/7/5/5	M	2	2.1	4.1	26	330	7C260P33R	D	11.0	LI533-H4	2	C/D/D/D	NOM
120/277/347	71A60A2-500DA	Super CWA	452	3.8/1.7/1.4	270	10/5/4	M	2	2.0	3.8	26	330	7C260P33R	D	11.0	LI533-H4	2	C/D	🍁
450W Lamp, ANSI Code M144 (Pulse Start)																			
480/120T	71A6343-500DTEE	Super CWA	514	1.1	267	3	M	2	2.4	4.2	26.5	360	7C265P40R	D	14.0	LI533-H4	5	D	ⓔ
120/208/277/347	71A6393-500DEE	Super CWA	508	4.3/2.5/2.2/1.9	257	10/8/5/5	M	2	2.3	3.9	26.5	360	7C265P40R	D	13.5	LI533-H4	5	C/C/C/C	ⓔ

† Ordering information:

Replacement/retrofit ballast kits – indicated by bold type and -001D or -001 suffix. Refer to pages 7-4 to 7-9 for more information on replacement kits.

Original equipment ballasts – typically ordered with capacitor (as shown).

- 500D includes core & coil with dry-film capacitor.
- 500 includes core & coil with oil-filled capacitor (required for higher wattage ballasts).

May also be available with welded bracket, and/or without capacitor:

- 510D includes core & coil with welded bracket and dry-film capacitor.
- 510 includes core & coil with welded bracket and oil-filled capacitor.
- 600 core & coil only (no capacitor).
- 610 core & coil with welded bracket (no capacitor).

†† Each ballast requiring an ignitor is furnished standard with a short-range ignitor model shown for use within fixtures. Long-range ignitors are available separately if required. See pages 7-39 to 7-43 for additional information.

• Maximum Input Current – For HX and R circuits, value is the highest of starting, operating or open circuit current. For CWA, SCWA and CWI circuits, value is the operating current.

** The 330 Watt Lamp, ANSI Code C185 is an energy saving, screw in replacement lamp for the M59 or M135 and M155 PS lamps that may reduce input watts up to 18% on existing ballasts.

NOM Certified ballast available for Mexican market. Add "ML" to suffix (example: -500DML). Ballasts are branded Philips.

🍁 Canadian replacement/retrofit ballast kit indicated by bold type. Refer to page 7-8.

⚡ Includes auto-reset thermal protection.

◆ Compact 3 x 4 core design.

ⓔ Meets EISA 88% efficiency requirements.

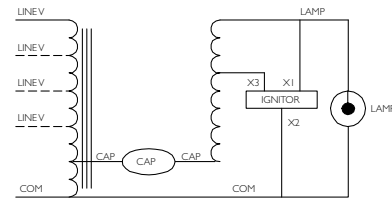

Fig. M

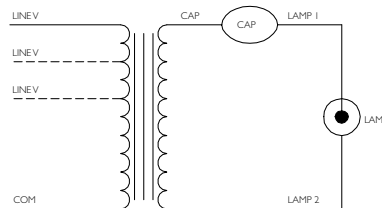

Fig. P

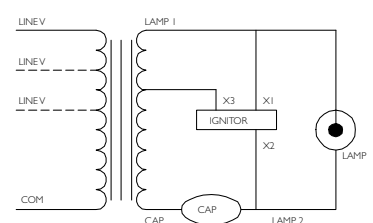

Fig. V

60 Hz Core & Coil Ballasts

Metal Halide



Input Volts	Catalog† Number	Circuit Type	Input Watts	Max Input Current	Nom Open Circuit Voltage	Fuse Rating (Amps)	Wiring Dia	Dimensions			Non-PCB Capacitor (Page 7-37 & 7-38)				Total Weight (lbs)	Ignitor †† (Page 7-39 to 7-43)		U.L. Bench Top Rise Code 1029 (pg 7-3)	
								Fig	A	B	Mfd	Min Volt	Cap Catalog Number	Dry or Oil		Part Number	Max Dist To Lamp (ft)		
750W Lamp, ANSI Code M149 (Pulse Start)																			
120/208/240/277/480	71A6452-001D	Super CWA	818	7/4/3.5/3/1.8	355	20/10/10/8/5	M	8	2.4	4.3	28	400	7C280S40	D	18.0	LI573-H5	15	D/C/D/D/C	A/A/A/A
120/208/240/277	71A6492-500DA	Super CWA	818	6.95/3.9/3.5/3.0	355	20/10/10/8	M	8	3.0	5	28	400	7C280S40	D	21.0	LI573-H5	3	B/A/A/A/A	A/A/A/A
277/347/480	71A64F2-001D	Super CWA	818	3.0/2.5/1.7	355	8/7/5	M	8	2.3	4.3	28	400	7C280S40	D	17.0	LI573-H5	15	E/E/E	A/A/A/A
277/347/480/120T	71A64F2-500DT	Super CWA	818	3.0/2.5/1.7	355	8/7/5	M	8	2.3	4.3	28	400	7C280S40	D	17.0	LI573-H5	15	E/E/E	A/A/A/A
◆ 120/208/240/277	71A6490-500D	Super CWA	820	7.0/4.0/3.5/3.0	340	15/9/8/8	M	2	3.0	4.9	28	400	7C280S40	D	17.5	LI573-H5	10	D/D/D/D	A/A/A/A
◆ 347/480/120T	71A64F0-600T	Super CWA	820	2.5/1.7	340	6/4	M	2	3.0	4.9	28	400	7C280S40	D	17.5	LI573-H5	10	E/E	A/A
875W Lamp, ANSI Code M166 (Pulse Start)																			
◆ 120/208/240/277	71A6498-500	Super CWA	940	7.8/4.3/3.9/3.4	415	20/10/10/8	M	2	3.0	5.0	21	480	MD2100-030	O	17.5	LI572-H5★	5	E/E/E/E	A/A/A/A
◆ 347/480/120T	71A64F8-500T	Super CWA	945	2.8/2.0	415	7/5	M	2	3.0	5.0	21	480	MD2100-030	O	17.5	LI572-H5★	5	E/E	A/A

WELDED BRACKET DIMENSIONS

Ballast Dimensions Fig	L	W	M	S
2, 10	6.5	1.25	5.75	0.28
8	7.8	2.75	6.13	0.25

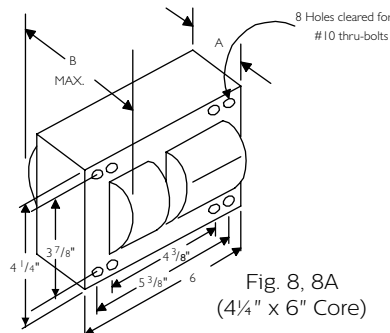
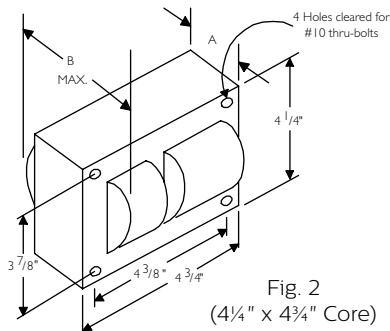
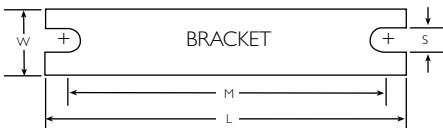

60 Hz Core & Coil Ballasts

Metal Halide



Input Volts	Catalog † Number	Circuit Type	Input Watts	Max* Input Current	Nom Open Circuit Voltage	Fuse Rating (Amps)	Wiring Dia	Dimensions			Non-PCB Capacitor (Page 7-37 & 7-38)				Ignitor †† (Page 7-39 to 7-43)		U.L. Bench Top Rise Code 1029 (pg 7-3)			
											Mfd	Min Volt	Cap Catalog Number	Dry or Oil	Total Weight (lbs)	Part Number		Max Dist To Lamp (ft)		
								Fig	A	B										
1000W Lamp, ANSI Code M47, or 860W Lamp, ANSI Code C194 (Philips AllStart)**																				
220	71A65J0-500ML	CWA	1080	4.9	415	12	A	2	3.3	5.3	24	480	MD2409-100	O	19.0	-	-	D	A	NOM
480/120T	71A6542-500T	CWA	1080	2.2	430	6	A	8	2.6	4.5	24	480	MD2409-100	O	21.0	-	-	D	A	
480/120T	71A6542-600TA 71A6542-001	CWA	1080	2.3	430	6	A	8	3.1	5.0	24	480	MD2409-100	O	21.0	-	-	D	A	NOM
120/208 240/277	71A6592-500	CWA	1080	9.0/5.2/ 4.5/3.9	430	20/15/ 10/10	A	8	2.6	4.5	24	480	MD2409-100	O	21.0	-	-	D/B/ B/B	A/A/ A/A	
120/208 240/277	71A6592-500A 71A6572-001	CWA	1080	9.0/5.2/ 4.5/3.9	430	20/15/ 10/10	A	8	3.1	5.0	24	480	MD2409-100	O	21.0	-	-	D/B/ B/B	A/A/ A/A	NOM
120/208/ 240/277/ 480	71A6552-500 71A6552-001CU	CWA	1080	9.0/5.6/ 4.7/4.1/ 2.4	426	22/15/ 12/10/ 6	A	8	3.0	4.7	24	480	MD2409-100	O	23.7	-	-	D/D/ D/C C	A/A/ A/A A	
120/208/ 240/277/ 480	71A6552-500A 71A6552-001	CWA	1090	9.2/5.8/ 4.8/4.1/ 2.4	430	25/15/ 12/10/ 6	A	8	3.9	5.6	24	480	MD2409-100	O	22.0	-	-	D/D/ D/C C	A/A/ A/A A	
120/ 277/347	71A65A2-500 71A65A2-001	CWA	1080	9.0/ 3.9/3.2	430	20/ 10/8	A	8	2.8	4.5	24	480	MD2409-100	O	21.0	-	-	D/ C/C	A/ A/A	♣
120/208 240/277	71A6590-500	CWA	1070	9.0/5.2/ 4.5/3.9	415	20/15/ 10/10	A	2	3.4	5.6	24	480	MD2409-100	O	19.0	-	-	D/D/ D/D	A/A/ A/A	NOM ♦
347/480/ 120T	71A65F0-600T	CWA	1070	3.1/2.2	415	8/6	A	2	3.4	5.3	24	480	MD2409-100	O	19.0	-	-	D/D	A/A	♦
208/240 120T	71A65E6-500DT	CWI	1080	5.3/4.8	440	15/12	P	8	3.5	5.3	20	560	7C400P30RA (Two in Series)	D	25.0	-	-	C/D	A/A	

† Ordering information:

Replacement/retrofit ballast kits – indicated by bold type and -001D or -001 suffix. Refer to pages 7-4 to 7-9 for more information on replacement kits.

Original equipment ballasts – typically ordered with capacitor (as shown).

- 500D includes core & coil with dry-film capacitor.
- 500 includes core & coil with oil-filled capacitor (required for higher wattage ballasts).

May also be available with welded bracket, and/or without capacitor:

- 510D includes core & coil with welded bracket and dry-film capacitor.
- 510 includes core & coil with welded bracket and oil-filled capacitor.
- 600 core & coil only (no capacitor).
- 610 core & coil with welded bracket (no capacitor).

†† Each ballast requiring an ignitor is furnished standard with a short-range ignitor model shown for use within fixtures. Long-range ignitors are available separately if required. See pages 7-39 to 7-43 for additional information.

• Maximum Input Current – For HX and R circuits, value is the highest of starting, operating or open circuit current. For CWA, SCWA and CWI circuits, value is the operating current.

** The 860 Watt Lamp, ANSI Code M194 is an energy saving, screw in replacement lamp for the M47 or M141 PS lamp that may reduce input watts up to 18% on existing ballasts.

NOM

Certified ballast available for Mexican market. Add "ML" to suffix (example: -500DML). Ballasts are branded Philips.



Canadian replacement/retrofit ballast kit indicated by bold type. Refer to page 7-8.

- ♦ Special compact 4¼ x 4¾ core design.

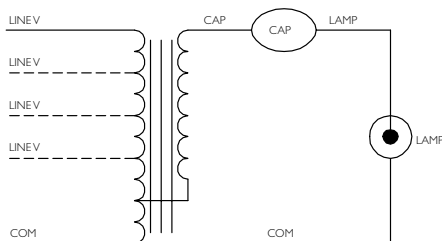

Fig. A

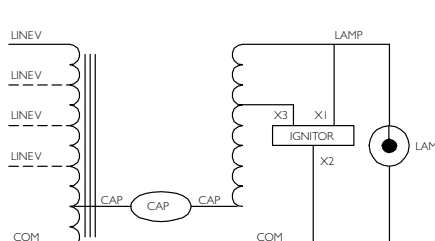

Fig. M

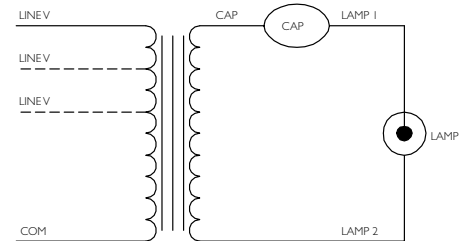

Fig. P

60 Hz Core & Coil Ballasts

Metal Halide



Input Volts	Catalog† Number	Circuit Type	Input Watts	Max Input Current	Nom Open Circuit Voltage	Fuse Rating (Amps)	Wiring Dia	Dimensions			Non-PCB Capacitor (Page 7-37 & 7-38)				Total Weight (lbs)	Ignitor †† (Page 7-39 to 7-43)		U.L. Bench Top Rise Code 1029 (pg 7-3)	
								Fig	A	B	Mfd	Min Volt	Cap Catalog Number	Dry or Oil		Part Number	Max Dist To Lamp (ft)		
1000W Lamp, ANSI Code M141 (Pulse Start), or 860W Lamp, ANSI Code C194 (Philips AllStart)**																			
480	71A6543-500A	Super CWA	1080	2.3	430	6	M	8	3.1	5.0	24	480	MD2409-000	O	21.0	LI572-H5★	5	D	A
120/208/240/277/480	71A6553-500	Super CWA	1080	9.1/5.6/4.7/4.1/2.4	426	22/15/12/10/6	M	8	3.0	4.7	24	480	MD2409-000	O	22.0	LI572-H5★	5	D/D/B/B	A/A/A/A
120/208/240/277/480	71A6553-001	Super CWA	1090	9.2/5.8/4.8/4.1/2.4	430	25/15/12/10/6	M	8	3.9	5.6	24	480	MD2409-000	O	25.0	LI572-H5★	5	D/D/C/C	A/A/A/A
120/208/240/277	71A6593-600	Super CWA	1080	9.0/5.2/4.5/3.9	430	20/15/10/10	M	8	2.8	4.5	24	480	MD2409-000	O	21.0	LI571-H5★	5	D/B/B/B	A/A/A/A
120/208/240/277	71A6593-001	Super CWA	1080	9.2/5.3/4.6/4.0	430	20/15/10/10	M	8	3.2	5.2	24	480	MD2409-000	O	25.0	LI571-H5★	5	D/B/B/B	A/A/A/A
347/480/120T	71A65F3-500T 71A65F3-001	Super CWA	1075	3.2/2.4	430	8/6	M	8	2.8	4.5	24	440	MD2409-000	O	21.0	LI571-H5★	5	D/D	A/A
277/347/480/120T	71A65F3-500TA	Super CWA	1080	4.0/3.3/2.3	430	10/8/6	M	8	3.3	5.3	24	440	MD2409-000	O	21.0	LI571-H5★	5	D/D/D	A/A/A
◆ 120/208/240/277	71A6591-600	Super CWA	1070	9.0/5.2/4.5/3.9	415	20/15/10/10	M	2	3.4	5.3	24	480	MD2409-000	O	19.0	LI572-H5★	5	D/D/D/D	A/A/A/A
◆ 347/480/120T	71A65F1-600T	Super CWA	1070	3.1/2.2	415	8/6	M	2	3.4	5.3	24	480	MD2409-000	O	19.0	LI572-H5★	5	D/D	A/A

WELDED BRACKET DIMENSIONS

Ballast Dimensions Fig	L	W	M	S
2	6.5	1.25	5.75	0.28
8	7.8	2.75	6.13	0.25

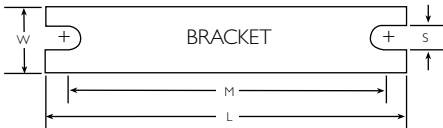

† Ordering information:

Replacement/retrofit ballast kits – indicated by bold type and -001D or -001 suffix. Refer to pages 7-4 to 7-9 for more information on replacement kits.

Original equipment ballasts – typically ordered with capacitor (as shown).

-500D includes core & coil with dry-film capacitor.

-500 includes core & coil with oil-filled capacitor (required for higher wattage ballasts).

May also be available with welded bracket, and/or without capacitor:

-510D includes core & coil with welded bracket and dry-film capacitor.

-510 includes core & coil with welded bracket and oil-filled capacitor.

-600 core & coil only (no capacitor).

-610 core & coil with welded bracket (no capacitor).

†† Each ballast requiring an ignitor is furnished standard with a short-range ignitor model shown for use within fixtures. Long-range ignitors are available separately if required. See pages 7-39 to 7-43 for additional information.

• **Maximum Input Current** – For HX and R circuits, value is the highest of starting, operating or open circuit current. For CWA, SCWA and CWI circuits, value is the operating current.

** The 860 Watt Lamp, ANSI Code M194 is an energy saving, screw in replacement lamp for the M47 or M141 PS lamp that may reduce input watts up to 18% on existing ballasts.

NOM Certified ballast available for Mexican market. Add "ML" to suffix (example: -500DML). Ballasts are branded Philips.

🇨🇦 Canadian replacement/retrofit ballast kit indicated by bold type. Refer to page 7-8.

◆ Special compact 4¼ x 4¼ core design.

60 Hz Core & Coil Ballasts

Metal Halide



Input Volts	Catalog † Number	Circuit Type	Input Watts	Max Input Current	Nom Open Circuit Voltage	Fuse Rating (Amps)	Wiring Dia	Dimensions			Non-PCB Capacitor (Page 7-37 & 7-38)				Total Weight (lbs)	Ignitor †† (Page 7-39 to 7-43)		U.L. Bench Top Rise Code 1029 (pg 7-3)	
								Fig	A	B	Mfd	Min Volt	Cap Catalog Number	Dry or Oil		Part Number	Max Dist To Lamp (ft)		
1500W Lamp, ANSI Code M48																			
480/120T	71A6742-600T	CWA	1625	3.4	450	10	A	8a	4.2	6.2	32	525	MD3202-100	O	31.0	-	-	E	A
480	71A6742-606A 71A6742-001	CWA	1610	3.5	460	10	A	8a	4.7	6.7	32	525	MD3202-100	O	30.0	-	-	E	A
120/208 240/277	71A6792-500	CWA	1605	13.5/7.8/ 6.8/5.9	450	30/25/ 20/15	A	8a	4.1	6.1	32	525	MD3202-100	O	30.0	-	-	G/E/ E/G	C/A/ A/C
120/208 240/277	71A6792-606A 71A6772-001	CWA	1610	13.5/7.8/ 6.8/5.9	460	30/25/ 20/15	A	8a	4.7	6.7	32	525	MD3202-100	O	30.0	-	-	G/E/ E/G	C/A/ A/C
120/ 277/347	71A67A2-600	CWA	1615	13.5/ 5.9/4.8	450	30/ 15/15	A	8a	4.1	6.1	32	525	MD3202-100	O	30.0	-	-	G/ G/G	C/ C/C
220	71A67J2-500	CWA	1610	7.4	440	25	A	8a	4.0	6.0	32	525	MD3202-100	O	29.0	-	-	F	B

NOM



WELDED BRACKET DIMENSIONS

Ballast Dimensions Fig	L	W	M	S
2	6.5	1.25	5.75	0.28
8	7.8	2.75	6.13	0.25
8a	7.8	4.50	6.75	0.31

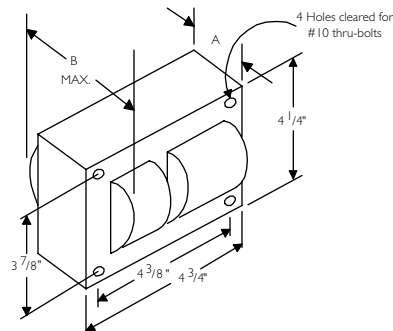
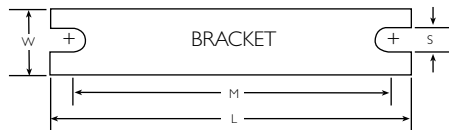

Fig. 2
(4 1/4" x 4 3/4" Core)

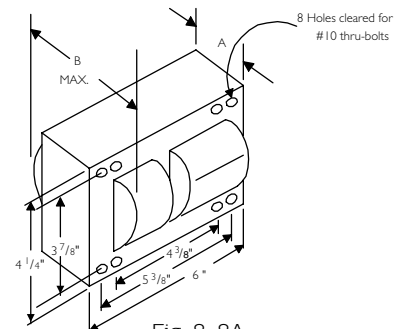

Fig. 8, 8A
(4 1/4" x 6" Core)

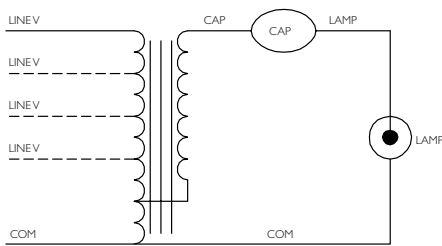

Fig. A

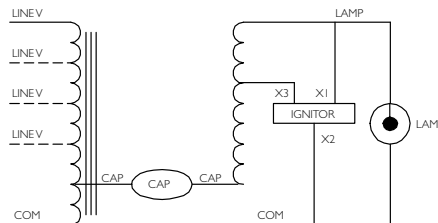

Fig. M

60 Hz Core & Coil Ballasts

High Pressure Sodium



Input Volts	Catalog † Number	Circuit Type	Input Watts	Max' Input Current	Nom Open Circuit Voltage	Fuse Rating (Amps)	Wiring Dia	Dimensions			Non-PCB Capacitor (Page 7-37 & 7-38)				Total Weight (lbs)	Ignitor †† (Page 7-39 to 7-43)		U.L. Bench Top Rise Code 1029 (pg 7-3)	
								Fig	A	B	Mfd	Min Volt	Cap Catalog Number	Dry or Oil		Part Number	Max Dist To Lamp (ft)		
35W Lamp, ANSI Code S76																			
120	71A7707-500D	R-HPF	46	.8	120	2	G	9	.7	1.8	14	120	7C140L12RA	D	1.3 1.5	LI551-H4	2	A	
120	71A7707-001DB	R-HPF	46	.8	120	2	H	9	.7	2.2	14	120	7C140L12RA	D	1.3 1.5	Integral Ignitor	2	A	
50W Lamp, ANSI Code S68																			
120	71A7807-500D	R-HPF	62	1.0	120	3	G	9	1.0	2.3	20	120	7C200M12RA	D	2.0	LI551-H4	2	A	
120	71A7807-600B 71A7807-001DB	R-NPF R-HPF	62	1.8 1.0	120	5 3	H	9	1.0	2.7	- 20	- 120	----- 7C200M12RA	- D	1.8 2.0	Integral Ignitor	2	A	
120/277	71A7801-500D 71A7801-001D	HX-HPF	66	1.0/.5	125	3/1	K	1	1.0	2.2	5	300	7C050L30RA	D	3.5	LI551-H4	2	A/A	
120/208/ 240/277	71A7891-001D	HX-HPF	66	1.0/.57/ .5/.45	125	3/2/ 2/1	K	1	1.0	2.2	5	300	7C050L30RA	D	3.5	LI551-H4	2	A/A A/A	

WELDED BRACKET DIMENSIONS

Ballast Dimensions Fig	L	W	M	S
1	5.1	1.00	4.50	0.25
9	4.0	0.75	3.50	0.28

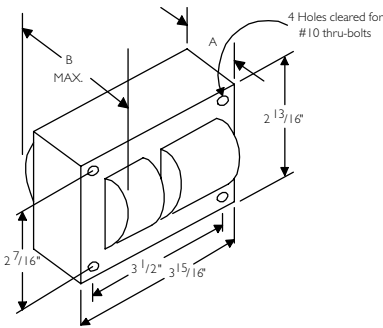
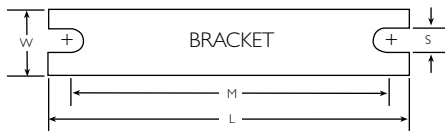

Fig. 1
(3" x 4" Core)

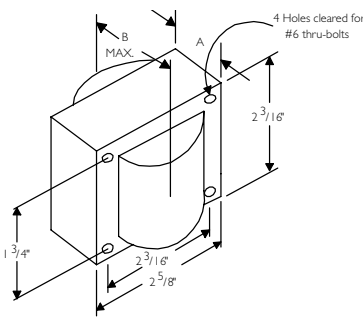

Fig. 9
(2⁵/₈" x 2³/₁₆" Reactor Core)

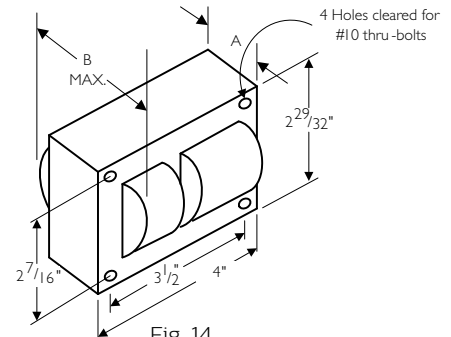

Fig. 14
(3" x 4" Core)

60 Hz Core & Coil Ballasts

High Pressure Sodium



Input Volts	Catalog† Number	Circuit Type	Input Watts	Max Input Current	Nom Open Circuit Voltage	Fuse Rating (Amps)	Wiring Dia	Dimensions			Non-PCB Capacitor (Page 7-37 & 7-38)				Total Weight (lbs)	Ignitor †† (Page 7-39 to 7-43)		U.L. Bench Top Rise Code 1029 (pg 7-3)
											Mfd	Min Volt	Cap Catalog Number	Dry or Oil		Part Number	Max Dist To Lamp (ft)	
								Fig	A	B								
70W Lamp, ANSI Code S62																		
120	71A7907-600 71A7907-500D	R-NPF R-HPF	86	2.1 1.3	120	8 3	G	9	1.3	2.5	—	—	-----	—	2.0	LI551-H4	2	A
120	71A7907-600B 71A7907-001DB	R-NPF R-HPF	86	2.1 1.3	120	8 3	H	9	1.3	2.9	—	—	-----	—	2.0	Integral Ignitor	2	A
480	71A7941-500D	HX-HPF	93	.4	120	2	K	1	1.9	3.2	7	300	7C070L30RA	D	6.5	LI551-H4	2	A
120/208 240/277	71A7991-500D	HX-HPF	96	1.4/.9 .8/.7	120	5/3/ 2/2	K	14	1.5	2.9	7	300	7C070L30RA	D	5.6	LI551-H4	2	B/C/ B/C
120/208 240/277	71A7971-001D	HX-HPF	96	1.4/.9 .8/.7	120	5/3/ 2/2	K	14	1.5	2.9	7	300	7C070L30RA	D	5.6	LI551-H4	2	B/C/ B/C
120/ 277/347	71A79A1-500D 71A79A1-001D	HX-HPF	93	1.4/ .7/.6	120	5/ 2/2	K	1	1.5	3.1	7	300	7C070L30RA	D	5.5	LI551-H4	2	A/ B/A
127/220	71A79H8-500DMLA	CWA	100	.8/.47	108	2/2	M	14	1.7	3.1	32.5	300	7C325P30RA	D	5.1	LI551-J4	2	B/C NOM
230	71A79J3-500D	CWA	98	0.45	110	2	M	14	1.6	3.0	28	170	7C280P30RA	D	5.7	LI551-H4	2	C
120/277	71A7988-500D	CWA	95	.9/.4	105	3/1	M	1	1.5	2.8	32.5	300	7C325P30-RA	D	5.5	LI551-J4	2	A/D
120/ 208/240	71A79E6-500D	CWI	95	.9/ .5/.5	110	3/ 2/2	V	1	1.6	2.9	24	300	7C240P30RA	D	5.8	LI551-J4	2	C C/B

† Ordering information:
Replacement/retrofit ballast kits – indicated by bold type and -001D or -001 suffix. Refer to pages 7-4 to 7-9 for more information on replacement kits.

Original equipment ballasts – typically ordered with capacitor (as shown).
-500D includes core & coil with dry-film capacitor.
-500 includes core & coil with oil-filled capacitor (required for higher wattage ballasts).

May also be available with welded bracket, and/or without capacitor:
-510D includes core & coil with welded bracket and dry-film capacitor.
-510 includes core & coil with welded bracket and oil-filled capacitor.
-600 core & coil only (no capacitor).
-610 core & coil with welded bracket (no capacitor).

†† Each ballast requiring an ignitor is furnished standard with a short-range ignitor model shown for use within fixtures. Long-range ignitors are available separately if required. See pages 7-39 to 7-43 for additional information.
• **Maximum Input Current** – For HX and R circuits, value is the highest of starting, operating or open circuit current. For CWA, SCWA and CWI circuits, value is the operating current.

NOM Certified ballast available for Mexican market. Add "ML" to suffix (example: -500DML). Ballasts are branded Philips.

Canadian replacement/retrofit ballast kit indicated by bold type. Refer to page 7-8.

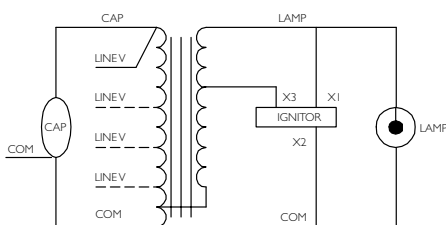
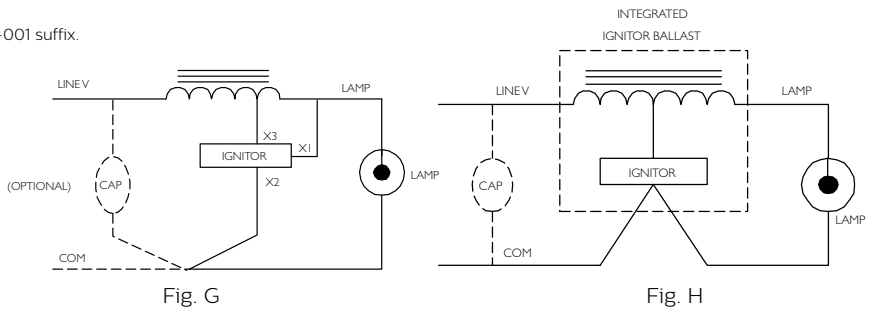

Fig. K

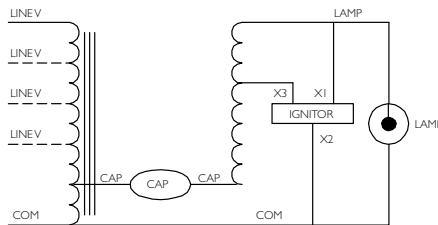

Fig. M

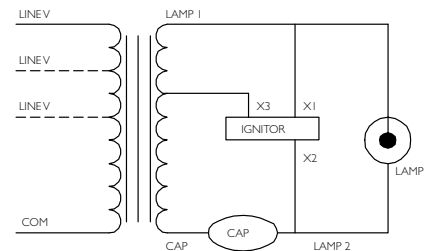

Fig. V

60 Hz Core & Coil Ballasts

High Pressure Sodium



Input Volts	Catalog† Number	Circuit Type	Input Watts	Max. Input Current	Nom Open Circuit Voltage	Fuse Rating (Amps)	Wiring Dia	Dimensions			Non-PCB Capacitor (Page 7-37 & 7-38)				Ignitor †† (Page 7-39 to 7-43)		U.L. Bench Top Rise Code 1029 (pg 7-3)	
											Mfd	Min Volt	Cap Catalog Number	Dry or Oil	Total Weight (lbs)	Part Number		Max Dist To Lamp (ft)
								Fig	A	B								
100W Lamp, ANSI Code S54																		
120	71A8007-500D	R-HPF	115	1.8	120	5	G	9	1.5	2.7	36	120	7C360M12RA	D	2.8	LI551-H4	2	A
120	71A8007-500DB 71A8007-001DB	R-HPF	115	1.8	120	5	H	9	1.5	3.0	36	120	7C360M12RA	D	2.8	Integral Ignitor	2	A
220	71A80J1-500D	HX-HPF	130	1.2	120	3	K	1	2.0	3.3	10	280	7C100M30RA	D	7.2	LI551-H4	2	B
480	71A8041-500D 71A8041-001D	HX-HPF	130	.6	120	3	K	1	2.3	3.6	10	280	7C100M30RA	D	7.5	LI551-H4	2	E
120/208/ 240/277	71A8091-500D	HX-HPF	135	2.2/1.3/ 1.1/.9	125	7/5/ 3/3	K	14	2.0	3.5	10	280	7C100M30RA	D	7.0	LI551-H4	2	E/F/ E/D
120/208/ 240/277	71A8071-001D	HX-HPF	135	2.2/1.3/ 1.1/.9	125	7/5/ 3/3	K	14	2.0	3.5	10	280	7C100M30RA	D	7.0	LI551-H4	2	E/F/ E/D
120/ 277/347	71A80A1-500D 71A80A1-001D	HX-HPF	130	2.2/ .9/.7	120	7/ 3/3	K	1	2.3	3.6	10	280	7C100M30RA	D	7.5	LI551-H4	2	C/ C/D
220	71A80J1-500D	HX-HPF	132	0.6	126	3	K	14	2.0	3.4	10	280	7C100M30RA	D	6.6	LI551-H4	2	B
120/277	71A8088-500D	CWA	138	1.2/.5	115	3/2	M	1	2.0	3.3	34	170	7C340P24RA	D	7.5	LI551-J4	5	F/F
NOM 127/277	71A80H8-500DMLA	CWA	140	1.1/.6	115	3/2	M	14	2.4	3.5	34	180	7C340P24RA	D	8.7	LI551-J4	2	D/D
230	71A80J3-500D	CWA	136	0.61	118	2	M	1	2.0	3.3	34	240	7C340P24RA	D	7.5	LI551-J4	5	E
NOM 220/240	71A80J9-500DML	CWA	124	.6/.6	114	2/2	M	14	2.8	4.5	36	180	7C360P24RAT	D	8.0	LI551-J4	5	A/A
120/ 208/240	71A80E6-500D	CWI	130	1.2/ .7/.6	108	3/ 2/2	V	1	2.1	3.4	35	170	7C350P24RA	D	6.8	LI551-J4	2	C/ C/B

WELDED BRACKET DIMENSIONS

Ballast Dimensions Fig	L	W	M	S
1	5.1	1.00	4.50	0.25
9	4.0	0.75	3.50	0.28

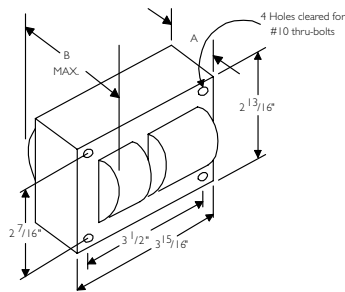
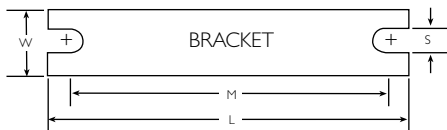

Fig. 1
(3" x 4" Core)

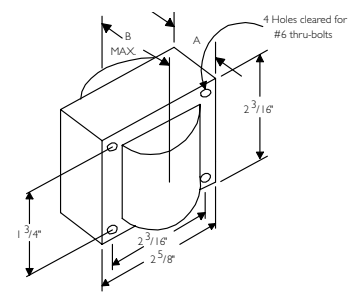

Fig. 9
(2 5/8" x 2 3/16" Reactor Core)

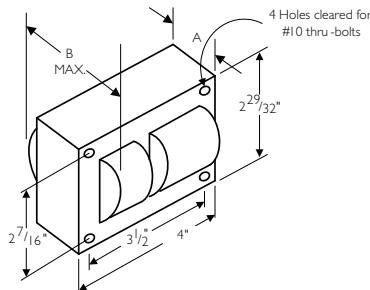

Fig. 14
(3" x 4" Core)

60 Hz Core & Coil Ballasts

High Pressure Sodium



Input Volts	Catalog† Number	Circuit Type	Input Watts	Max Input Current	Nom Open Circuit Voltage	Fuse Rating (Amps)	Wiring Dia	Dimensions			Non-PCB Capacitor (Page 7-37 & 7-38)				Total Weight (lbs)	Ignitor †† (Page 7-39 to 7-43)		U.L. Bench Top Rise Code 1029 (pg 7-3)	
								Fig	A	B	Mfd	Min Volt	Cap Catalog Number	Dry or Oil		Part Number	Max Dist To Lamp (ft)		
150W Lamp, ANSI Code S55 (55V Arc Tube)																			
120	71A8107-600 71A8107-500D	R-NPF R-HPF	170	4.5 2.4	120	15 8	G	9	2.0	3.3	— 55	— 120	— 7C550P12RA	— D	3.5 4.0	LI551-H4	2	A	
120	71A8107-600B 71A8107-001DB	R-NPF R-HPF	170	4.5 2.4	120	15 8	H	9	2.0	3.6	— 55	— 120	— 7C550P12RA	— D	3.5 4.0	Integral Ignitor	2	A	
220	71A81J2-500D	HX-HPF	188	1.5	120	4	K	1	2.6	3.8	14	280	7C140M30RA	D	7.5	LI551-H4	2	C	
480	71A8142-001D	HX-HPF	188	0.7	120	2	K	1	3.0	4.3	14	280	7C140M30RA	D	9.0	LI551-H4	2	E	
480/120T	71A8142-500DT	HX-HPF	188	0.7	120	2	K	1	3.0	4.3	14	280	7C140M30RA	D	9.0	LI551-H4	2	E	
120/208/ 240/277	71A8192-500D	HX-HPF	190	2.8/1.6/ 1.4/1.3	120	10/5/ 5/4	K	14	2.5	4.2	14	280	7C140M30RA	D	7.7	LI551-H4	2	E/E/ E/E	
120/208/ 240/277	71A8172-001D	HX-HPF	190	2.8/1.6/ 1.4/1.3	120	10/5/ 5/5	K	14	2.5	4.2	14	280	7C140M30RA	D	8.2	LI551-H4	2	E/E/ E/E	
120/ 277/347	71A81A2-500D 71A81A2-001D	HX-HPF	196	2.8/ 1.3/1.0	125	10/ 4/3	K	14	2.6	4.1	14	280	7C140M30RA	D	7.9	LI551-H4	2	D/ D/D	

NOM



† Ordering information:

Replacement/retrofit ballast kits – indicated by bold type and -001D or -001 suffix. Refer to pages 7-4 to 7-9 for more information on replacement kits.

Original equipment ballasts – typically ordered with capacitor (as shown).
-500D includes core & coil with dry-film capacitor.
-500 includes core & coil with oil-filled capacitor (required for higher wattage ballasts).

May also be available with welded bracket, and/or without capacitor:
-510D includes core & coil with welded bracket and dry-film capacitor.
-510 includes core & coil with welded bracket and oil-filled capacitor.
-600 core & coil only (no capacitor).
-610 core & coil with welded bracket (no capacitor).

†† Each ballast requiring an ignitor is furnished standard with a short-range ignitor model shown for use within fixtures. Long-range ignitors are available separately if required. See pages 7-39 to 7-43 for additional information.

• Maximum Input Current – For HX and R circuits, value is the highest of starting, operating or open circuit current. For CWA, SCWA and CWI circuits, value is the operating current.

NOM Certified ballast available for Mexican market. Add "ML" to suffix (example: -500DML). Ballasts are branded Philips.

Canadian replacement/retrofit ballast kit indicated by bold type. Refer to page 7-8.
LL Special high efficiency/ low-loss ballast.

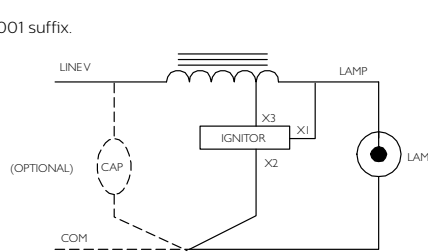

Fig. G

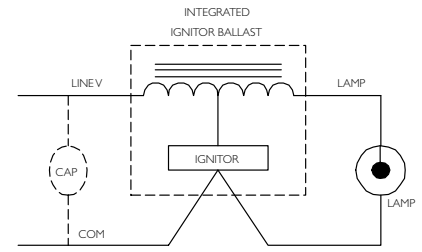

Fig. H

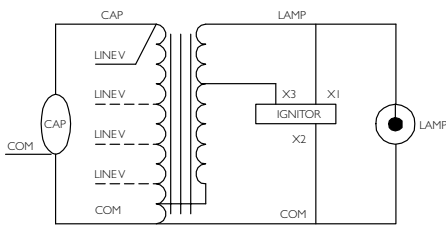

Fig. K

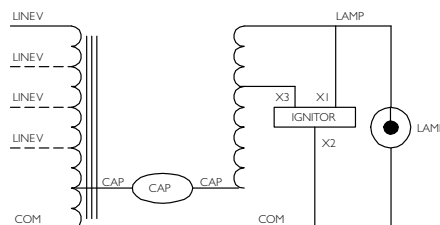

Fig. M

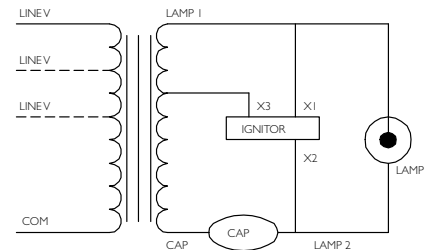

Fig. V

60 Hz Core & Coil Ballasts

High Pressure Sodium



Input Volts	Catalog† Number	Circuit Type	Input Watts	Max' Input Current	Nom Open Circuit Voltage	Fuse Rating (Amps)	Wiring Dia	Dimensions			Non-PCB Capacitor (Page 7-37 & 7-38)				Total Weight (lbs)	Ignitor †† (Page 7-39 to 7-43)		U.L. Bench Top Rise Code 1029 (pg 7-3)	
								Fig	A	B	Mfd	Min Volt	Cap Catalog Number	Dry or Oil		Part Number	Max Dist To Lamp (ft)		
150W Lamp, ANSI Code S55 (55V Arc Tube)																			
	120/277	71A8188-500D	CWA	138	1.15/5	115	3/2	M	1	2.0	3.3	34	170	7C340P24RA	D	7.5	LI551-J4	5	F/F
NOM	127/220	71A81H8-500DMLA	CWA	190	1.6/9	110	5/3	M	14	3.0	4.5	55	170	7C550P24RA	D	9.7	LI551-J4	10	D/C
	480	71A8148-500D	CWA	188	0.5	110	1	M	1	2.5	3.8	55	170	7C550P24RA	D	8.0	LI551-J4	10	E
	230	71A81J3-500D	CWA	196	0.86	113	5	M	1	2.8	4.3	55	240	7C550P24RA	D	9.3	LI551-J4	10	E
LL NOM	220/240	71A81J9-500DML	CWA	170	0.8/0.7	110	2/2	M	2	2.2	3.9	60	240	7C600P24RAT1	D	13.5	LI551-J4	2	A/A
	120/208/240	71A81E6-500D	CWI	190	1.8 1/9	105	5/3/3	V	1	2.6	4.0	52	240	7C520P24RA	D	8.5	LI551-J4	2	E/ E/D
150W Lamp, ANSI Code S56 (100V Arc Tube)																			
	480	71A8146-001D	CWA	188	0.5	180	2	M	1	2.5	3.8	20	280	7C200P30RA	D	8.5	LI501-H4	2	B
	120/208 240/277	71A8196-500D	CWA	188	1.7/1.0 .9/8	180	5/3/3/3	M	1	2.5	4.1	20	280	7C200P30RA	D	8.5	LI501-H4	2	E/D/ C/C
	120/208 240/277	71A8176-001D	CWA	188	1.7/1.0 .9/8	180	5/3/3/3	M	1	2.5	4.1	20	280	7C200P30RA	D	8.5	LI501-H4	2	E/D/ C/C

WELDED BRACKET DIMENSIONS

Ballast Dimensions Fig	L	W	M	S
1	5.1	1.00	4.50	0.25
2	6.5	1.25	5.75	0.28
9	4.0	0.75	3.50	0.28

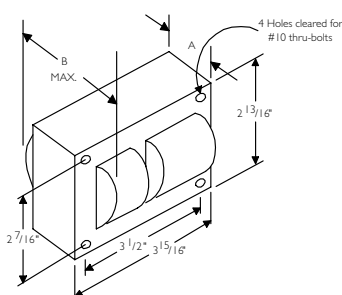
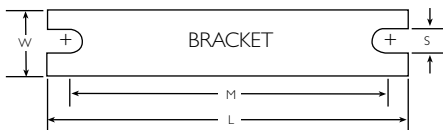

Fig. 1
(3" x 4" Core)

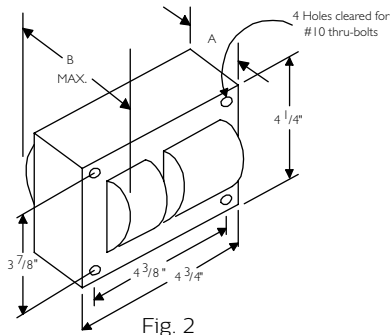

Fig. 2
(4 1/4" x 4 3/4" Core)

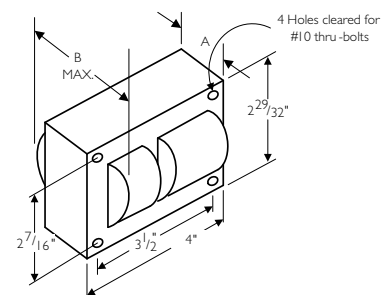

Fig. 14
(3" x 4" Core)

60 Hz Core & Coil Ballasts

High Pressure Sodium



Input Volts	Catalog† Number	Circuit Type	Input Watts	Max* Input Current	Nom Open Circuit Voltage	Fuse Rating (Amps)	Wiring Dia	Dimensions			Non-PCB Capacitor (Page 7-37 & 7-38)				Total Weight (lbs)	Ignitor †† (Page 7-39 to 7-43)		U.L. Bench Top Rise Code 1029 (pg 7-3)	
								Fig	A	B	Mfd	Min Volt	Cap Catalog Number	Dry or Oil		Part Number	Max Dist To Lamp (ft)		
200W Lamp, ANSI Code S66																			
120/208/240/277	71A8990-500D	CWA	240	2.2/1.3 1.1/1.0	185	6/4/ 3/3	M	2	1.2	3.0	28	280	7C280P30RA	D	8.5	LI501-H4	2	E/D/ D/D	
120/208/240/277	71A8970-001D	CWA	240	2.2/1.3 1.1/1.0	185	6/4/ 3/3	M	2	1.2	3.0	28	280	7C280P30RA	D	8.5	LI501-H4	2	E/D/ D/D	
120/208/240/277	71A8991-500D	CWA	250	2.4/1.4 1.2/1.0	195	8/5/ 5/3	M	1	3.0	4.2	24	280	7C240P30RA	D	8.5	LI501-H4	2	H/G/ H/I	

† Ordering information:

Replacement/retrofit ballast kits – indicated by bold type and -001D or -001 suffix. Refer to pages 7-4 to 7-9 for more information on replacement kits.

Original equipment ballasts – typically ordered with capacitor (as shown).

- 500D includes core & coil with dry-film capacitor.
- 500 includes core & coil with oil-filled capacitor (required for higher wattage ballasts).

May also be available with welded bracket, and/or without capacitor:

- 510D includes core & coil with welded bracket and dry-film capacitor.
- 510 includes core & coil with welded bracket and oil-filled capacitor.
- 600 core & coil only (no capacitor).
- 610 core & coil with welded bracket (no capacitor).

†† Each ballast requiring an ignitor is furnished standard with a short-range ignitor model shown for use within fixtures. Long-range ignitors are available separately if required. See pages 7-39 to 7-43 for additional information.

• Maximum Input Current – For HX and R circuits, value is the highest of starting, operating or open circuit current. For CWA, SCWA and CWI circuits, value is the operating current.

NOM

Certified ballast available for Mexican market. Add "ML" to suffix (example: -500DML). Ballasts are branded Philips.

🍁 Canadian replacement/retrofit ballast kit indicated by bold type. Refer to page 7-8.

LL Special high efficiency/ low-loss ballast.

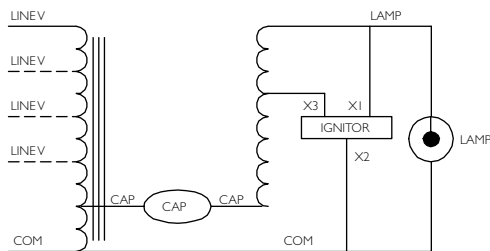

Fig. M

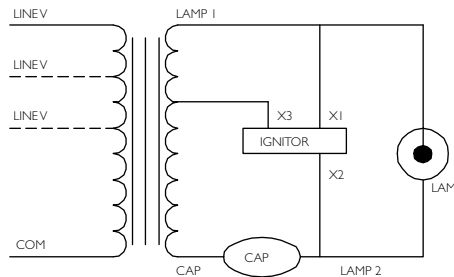

Fig. V

60 Hz Core & Coil Ballasts

High Pressure Sodium



Input Volts	Catalog† Number	Circuit Type	Input Watts	Max' Input Current	Nom Open Circuit Voltage	Fuse Rating (Amps)	Wiring Dia	Dimensions			Non-PCB Capacitor (Page 7-37 & 7-38)				Total Weight (lbs)	Ignitor †† (Page 7-39 to 7-43)		U.L. Bench Top Rise Code 1029 (pg 7-3)	
								Fig	A	B	Mfd	Min Volt	Cap Catalog Number	Dry or Oil		Part Number	Max Dist To Lamp (ft)		
250W Lamp, ANSI Code S50 or M168 (Philips Retro White)																			
NOM	127/220	71A82HI-500DMLA	CWA	295	2.5/1.4	189	7/4	M	2	1.8	3.6	35	240	7C350P24RA	D	10.0	LI501-H4	2	A/A
	480/120T	71A8241-500DT	CWA	310	.7	187	2	M	2	1.8	3.5	35	240	7C350P24RA	D	11.0	LI501-H4	2	B
	480/120T	71A8241-500DTA 71A8241-001D	CWA	300	.7	189	2	M	2	1.8	3.7	35	240	7C350P24RA	D	11.0	LI501-H4	2	B
NOM	120/208/ 240/277	71A8291-500DA 71A8291-500DMLA	CWA	295	2.5/1.5/ 1.3/1.1	187	7/4/ 4/3	M	2	1.8	3.8	35	240	7C350P24RA	D	11.0	LI501-H4	2	B/B/ B/B
	120/208/ 240/277	71A8271-001D	CWA	295	2.5/1.5/ 1.3/1.1	187	7/4/ 4/3	M	2	1.8	3.8	35	240	7C350P24RA	D	11.0	LI501-H4	2	B/B/ B/B
	120/208/ 240/277/ 480	71A8251-500DA 71A8251-001D	CWA	300	2.7/1.5/ 1.3/1.2/ .7	188	7/4/ 4/3/ 2	M	2	2.0	3.7	35	240	7C350P24RA	D	12.0	LI501-H4	2	C/C/ B/B/ B
	120/ 277/347	71A82A1-500D 71A82A1-001D	CWA	295	2.7/ 1.2/.9	187	7/ 3/2	M	2	2.0	3.6	35	240	7C350P24RA	D	11.5	LI501-H4	2	C/ C/B
	230	71A82J3-500D	CWA	293	1.3	188	4	M	2	1.8	3.4	34	240	7C340P24RA	D	11.0	LI501-H4	2	B
LL NOM	220/240	71A82J9-500DML	CWA	285	1.4/1.3	188	4/4	M	2	1.8	3.4	34	240	7C240P24RAT1	D	11.0	LI501-H4	5	A/A
	120/ 208/240	71A82E6-500D	CWI	300	2.8/ 1.6/1.4	190	8/ 5/5	V	2	1.9	3.8	28	300	7C280P30RA	D	11.0	LI501-J4	2	D/ D/C

WELDED BRACKET DIMENSIONS

Ballast Dimensions Fig	L	W	M	S
1	5.1	1.00	4.50	0.25
2	6.5	1.25	5.75	0.28

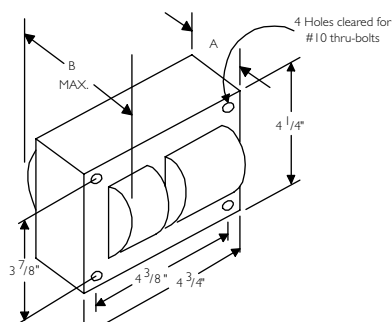
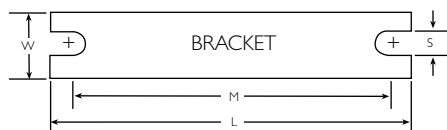

Fig. 2
(4 1/4" x 4 3/4" Core)

60 Hz Core & Coil Ballasts

High Pressure Sodium



Input Volts	Catalog † Number	Circuit Type	Input Watts	Max* Input Current	Nom Open Circuit Voltage	Fuse Rating (Amps)	Wiring Dia	Dimensions			Non-PCB Capacitor (Page 7-37 & 7-38)				Total Weight (lbs)	Ignitor †† (Page 7-39 to 7-43)		U.L. Bench Top Rise Code 1029 (pg 7-3)
								Fig	A	B	Mfd	Min Volt	Cap Catalog Number	Dry or Oil		Part Number	Max Dist To Lamp (ft)	
310W Lamp, ANSI Code S67																		
120/208/240/277/480	71A8351-500DA	CWA	367	3.12/1.7/1.55/1.33/0.77	183	8/5/4/4/2	M	2	2.4	4.1	45	280	7C450P30RA	D	14.0	LI501-H4	2	C/A/B/B/B
400W Lamp, ANSI Code S51 or M169 (Philips Retro White)																		
480/120T	71A8443-500DT	CWA	464	1.0	190	3	M	2	2.3	4.0	55	240	7C550P24RA	D	15.0	LI501-H4	2	D
480/120T	71A8443-001D	CWA	464	1.0	190	3	M	2	2.8	4.3	55	240	7C550P24RA	D	16.0	LI501-H4	2	D
120/208/240/277	71A8493-500D	CWA	464	3.8/2.2/1.9/1.7	190	10/8/5/5	M	2	2.1	4.3	55	240	7C550P24RA	D	13.5	LI501-H4	2	D/D/D/D
120/208/240/277/480	71A8493-500DA 71A8473-001D	CWA	464	3.8/2.2/1.9/1.7	187	10/8/5/5	M	2	2.6	4.3	55	240	7C550P24RA	D	16.0	LI501-H4	2	D/D/D/D
120/208/240/277/480	71A8453-500D 71A8453-001D	CWA	465	3.9/2.2/1.9/1.7/1.0	195	10/6/5/5/3	M	2	2.7	4.8	55	240	7C550P24RA	D	16.0	LI501-H4	2	C/C/D/D/C
120/277/347	71A84A3-500D 71A84A3-001D	CWA	465	3.9/1.7/1.4	190	10/5/5	M	2	2.3	4.5	55	240	7C550P24RA	D	14.4	LI501-H4	2	D/D/D
230/400/480	71A84Y3-500D	CWA	465	2.0/1.2/1.0	190	5/3/3	M	2	2.7	4.7	55	300	7C550P24RA	D	15.8	LI501-H4	2	D/C/C
120/208/240	71A84E6-500D	CWI	465	4.2/2.4/2.1	190	10/7/5	V	2	2.7	4.4	48	300	7C480P30RA	D	15.5	LI501-J4	2	E/E/E

NOM

† Ordering information:

Replacement/retrofit ballast kits – indicated by bold type and -001D or -001 suffix. Refer to pages 7-4 to 7-9 for more information on replacement kits.

Original equipment ballasts – typically ordered with capacitor (as shown).

- 500D includes core & coil with dry-film capacitor.
- 500 includes core & coil with oil-filled capacitor (required for higher wattage ballasts).

May also be available with welded bracket, and/or without capacitor:

- 510D includes core & coil with welded bracket and dry-film capacitor.
- 510 includes core & coil with welded bracket and oil-filled capacitor.
- 600 core & coil only (no capacitor).
- 610 core & coil with welded bracket (no capacitor).

†† Each ballast requiring an ignitor is furnished standard with a short-range ignitor model shown for use within fixtures. long-range ignitors are available separately if required. See pages 7-39 to 7-43 for additional information.

- Maximum Input Current – For HX and R circuits, value is the highest of starting, operating or open circuit current. For CWA, SCWA and CWI circuits, value is the operating current.

NOM Certified ballast available for Mexican market. Add "ML" to suffix (example: -500DML). Ballasts are branded Philips.

Canadian replacement/retrofit ballast kit indicated by bold type. Refer to page 7-8.

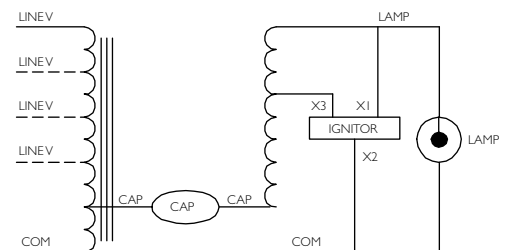

Fig. M

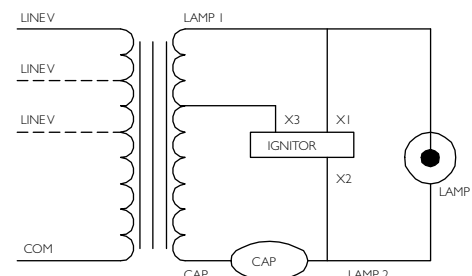

Fig. V

60 Hz Core & Coil Ballasts

High Pressure Sodium



Input Volts	Catalog† Number	Circuit Type	Input Watts	Max Input Current	Nom Open Circuit Voltage	Fuse Rating (Amps)	Wiring Dia	Dimensions			Non-PCB Capacitor (Page 7-37 & 7-38)				Total Weight (lbs)	Ignitor †† (Page 7-39 to 7-43)		U.L. Bench Top Rise Code 1029 (pg 7-3)	
								Fig	A	B	Mfd	Min Volt	Cap Catalog Number	Dry or Oil		Part Number	Max Dist To Lamp (ft)		
600W Lamp, ANSI Code S106																			
120/208/240	71A85E5-500D	CWA	670	5.5/3.3/2.9	220	15/9/8	M	8a	3.2	5.1	64	280	7C640S28RA	D	22.5	LI561-H5	2	A/A/B	A/A/A
277/347/480	71A85F5-500D	CWA	665	2.5/2.0/1.4	228	7/5/4	M	8a	3.1	4.9	64	280	7C640S28RA	D	23.0	LI561-H5	5	A/A/A	A/A/A
750W Lamp, ANSI Code S111																			
120/208/240	71A86E5-500D	CWA	840	6.8/4.0/3.5	220	20/10/10	M	8a	3.2	5.1	75	280	7C750S28RA	D	22.5	LI561-H5	5	D/E/E	A/A/A
277/347/480	71A86F5-500D	CWA	840	3.1/2.5/1.8	225	10/10/5	M	8a	3.2	5.1	75	280	7C750S28RA	D	23.0	LI561-H5	5	E/D/D	A/A/A
1000W Lamp, ANSI Code S52																			
480	71A8743-500 71A8743-001	CWA	1100	2.3	435	6	M	8a	3.9	5.9	26	525	MD2602-100	O	29.7	LI571-H5★	15	C	A
480/120T	71A8743-600T	CWA	1100	2.3	435	6	M	8a	3.9	5.9	26	525	MD2602-100	O	28.0	LI571-H5★	15	C	A
NOM 120/208/240/277	71A8793-500 71A8793-500ML	CWA	1100	9.5/5.5/4.8/4.2	441	25/15/10/10	M	8a	3.8	5.8	26	525	MD2602-100	O	28.5	LI571-H5★	15	C/B/C/C	A/A/A/A
120/208/240/277	71A8773-001	CWA	1100	9.5/5.5/4.8/4.2	441	25/15/10/10	M	8a	3.8	5.8	26	525	MD2602-100	O	29.7	LI571-H5★	15	C/B/C/C	A/A/A/A
120/208/240/277/480	71A8753-600 71A8753-001	CWA	1100	9.3/5.3/4.7/4.1/2.3	437	25/15/12/10/6	M	8a	4.0	6.0	26	525	MD2602-100	O	29.0	LI571-H5★	15	C/C/C/C/C	A/A/A/A/A
★ 120/277/347	71A87A3-500 71A87A3-001	CWA	1100	9.5/4.2/3.3	435	25/15/10	M	8a	3.9	5.9	26	525	MD2602-100	O	28.0	LI571-H5★	15	C/C/C/C	A/A/A/A

WELDED BRACKET DIMENSIONS

Ballast Dimensions Fig	L	W	M	S
2	6.5	1.25	5.75	0.28
8a	7.8	4.50	6.75	0.31

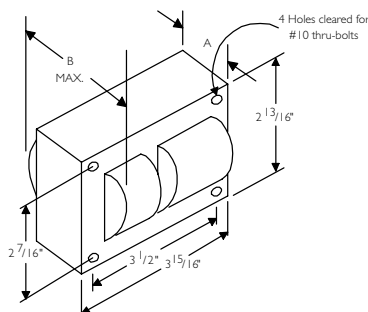
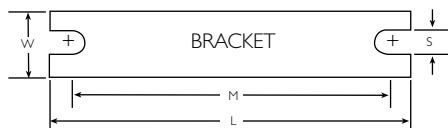

Fig. 1
(3" x 4" Core)

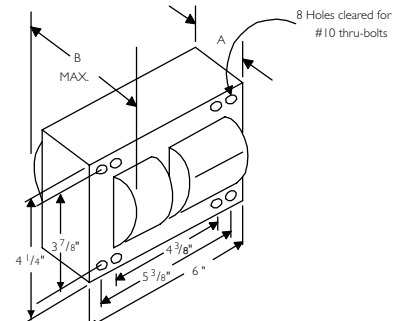

Fig. 8, 8A
(4 1/4" x 6" Core)

60 Hz Core & Coil Ballasts

Low Pressure Sodium



Input Volts	Catalog † Number	Circuit Type	Input Watts	Max* Input Current	Nom Open Circuit Voltage	Fuse Rating (Amps)	Wiring Dia	Dimensions			Non-PCB Capacitor (Page 7-37 & 7-38)				Total Weight (lbs)	U.L. Bench Top Rise Code 1029 (pg 7-3)
								Fig	A	B	Mfd	Min Volt	Cap Catalog Number	Dry or Oil		
18W Lamp, ANSI Code L69																
120/277	71A0280-500D	HX-HPF	30	.9/.4	315	3/2	Q	1	1.0	2.4	5	250	7C050L30RA	D	4.5	A/A
35W Lamp, ANSI Code L70 or 55W Lamp, ANSI Code L71																
120/208/ 240/277	71A0490-500D 71A0490-001D	HX-HPF/ HX-PFC	60 or 80	2.4/1.4/ 1.2/1.0	480	6/4/ 3/3	Q	1	2.3	3.5	14	240	7C140M30RA	D	8.0	A/A/ A/A

† Ordering information:

Replacement/retrofit ballast kits – indicated by bold type and -001D or -001 suffix.

Refer to pages 7-4 to 7-9 for more information on replacement kits.

Original equipment ballasts – typically ordered with capacitor (as shown).

-500D includes core & coil with dry-film capacitor.

-500 includes core & coil with oil-filled capacitor (required for higher wattage ballasts).

May also be available with welded bracket, and/or without capacitor:

-510D includes core & coil with welded bracket and dry-film capacitor.

-510 includes core & coil with welded bracket and oil-filled capacitor.

-600 core & coil only (no capacitor).

-610 core & coil with welded bracket (no capacitor).

• **Maximum Input Current** – For HX and R circuits, value is the highest of starting, operating or open circuit current. For CWA, SCWA and CWI circuits, value is the operating current.

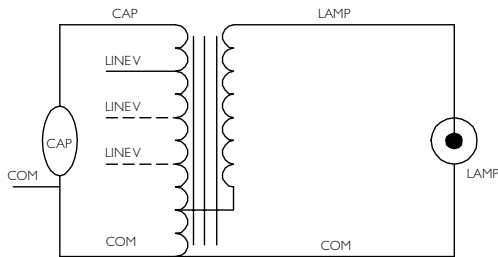

Fig. Q

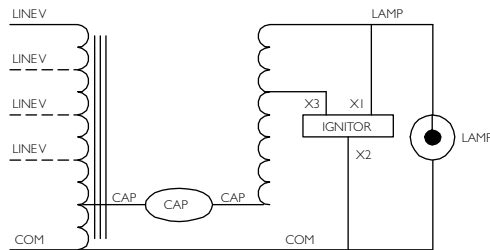

Fig. M

60 Hz Core & Coil Ballasts

Low Pressure Sodium



Input Volts	Catalog † Number	Circuit Type	Input Watts	Max* Input Current	Nom Open Circuit Voltage	Fuse Rating (Amps)	Wiring Dia	Dimensions			Non-PCB Capacitor (Page 7-37 & 7-38)				Total Weight (lbs)	U.L. Bench Top Rise Code 1029 (pg 7-3)
								Fig	A	B	Mfd	Min Volt	Cap Catalog Number	Dry or Oil		
90W Lamp, ANSI Code L72																
120/208/240/277	71A0590-500D	HX-HPF	125	4.1/2.3/2.0/1.75	515	11/6/5/5	Q4	2	1.8	3.3	17.5	300	7C175M30RA	D	10.0	A/A/A/A/A
347/480	71A05F0-500D	HX-HPF	125	1.35/0.9E	520	4/3	Q2	2	1.8	3.4	16.0	300	7C160M30RA	D	10.2	A/A
135W Lamp, ANSI Code L73 or 180W Lamp, ANSI Code L74																
120/208/240/277	71A0790-510D	HX-HPF	180 or 208	5.28/2.82/2.62/2.25	695	15/7/7/6	Q	3a	2.4	4.0	16	330	7C160P40	D	15.3	A/A/A/A/A
347/480	71A07F0-500D	HX-HPF	182 or 213	1.82/1.33	690	5/4	Q2	3a	2.4	4.0	16	330	7C160P40	D	15.0	A/A

WELDED BRACKET DIMENSIONS

Ballast Dimensions Fig	L	W	M	S
1	5.1	1.00	4.50	0.25
2	6.5	1.25	5.75	0.28
3a	7.8	2.75	6.13	0.25

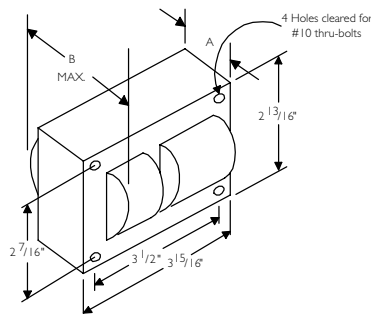
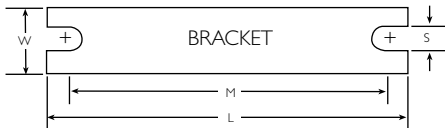

Fig. 1
(3" x 4" Core)

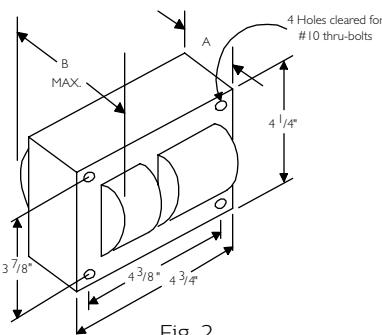

Fig. 2
(4 1/4" x 4 3/4" Core)

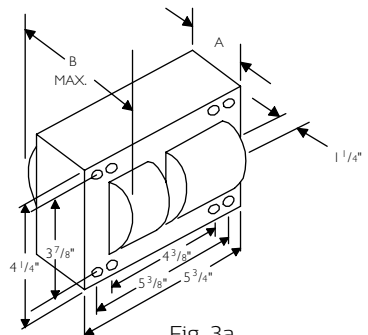

Fig. 3a
(4 1/4" x 5 3/4" Core)

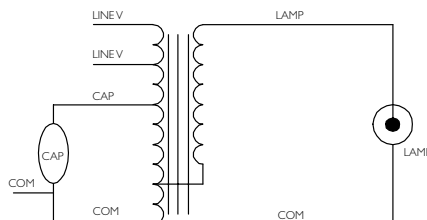

Fig. Q2

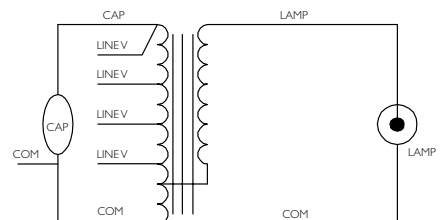

Fig. Q4

Capacitor Specifications

Recommended Capacitors for Bi-level Dimming of Specified HID Lamps* on CWA Ballasts

* For Ceramic Metal Halide lamps, please consult the lamp manufacturer for the recommended dimming level.

Philips Advance Ballast Family	Nominal Lamp Watts	ANSI Code	Lamp Watts at Low Light	Full Light Capacitance Mfd.	Low Light Capacitance Mfd.	Primary Capacitor	Secondary Capacitor	Capacitor Connection
Quartz Metal Halide 60Hz CWA/Super CWA Ballasts								
71A53_3	100 Pulse-Start	M90/140	60	10.0	8.0	10.0 mfd 400V (7C100M40R)	40.0 mfd, 300V (7C400P30RA)	Series
71A54A3	150 Pulse-Start	M102/142	85	22.0	14.0	22.0 mfd, 240V (7C220M24RA)	40.0 mfd, 300V (7C400P30RA)	Series
71A5493	150 Pulse-Start	M102/142	80	16.0	12.0	16.0 mfd, 300V (72160M30RA)	40.0 mfd, 300V (7C400P30RA)	Series
71A55_0	175	M57	110	10.0	8.0	10 mfd, 400V (7C100M40-R)	40.0 mfd, 300V (7C400P30RA)	Series
71A55_3	175 Pulse-Start	M137 or M152	110	11.0	8.5	11 mfd, 400V (7C110M40)	40.0 mfd, 300V (7C400P30RA)	Series
71A56_2 or 71A56_3	200 Pulse-Start	M136	120	15.0	11.0	15 mfd, 330V (7C150M33)	40.0 mfd, 300V (7C400P30RA)	Series
71A57_0 or 71A57_1	250	M58	150	15.0	11.0	15 mfd, 400V (7C150P40-R)	40.0 mfd, 300V (7C400P30RA)	Series
71A57_2	250 Pulse-Start	M138 or M153	150	17.0	12.0	17 mfd, 400V (7C170P40)	40.0 mfd, 300V (7C400P30RA)	Series
71A58_2	320 Pulse-Start	M132 or M154	175	21.0	14.0	21 mfd, 400V (7C210P40R)	40.0 mfd, 300V (7C400P30RA)	Series
71A59_3	350 Pulse-Start	M131	205	22.5	14.5	22.5 mfd, 400V (7C225P40)	40.0 mfd, 300V (7C400P30RA)	Series
71A60_1	400	M59	220	24.0	17.0	24 mfd, 400V (7C240P40-R)	48 mfd, 300V (7C480P30RA)	Series
71A60_2	400 Pulse-Start	M135 or M155	210	26.0	18.0	26 mfd, 330V (7C260P33R)	48 mfd, 300V (7C480P30RA)	Series
71A63_3	450 Pulse-Start	M144	235	26.5	20.0	26.5 mfd, 400V (7C265P40R)	75.0 mfd, 280V (7C280S28RA)	Series
71A64_0 or 71A64_2	750 Pulse-Start	M149	420	28.0	18.0	28 mfd, 400V (7C280S40)	48 mfd, 300V (7C480P30RA)	Series
71A64_8	875 Pulse-Start	M166	485	21.0	14.0	21 mfd 480V (MD2100-030)	40.0 mfd, 300V (7C400P30RA)	Series
71A65_0, 71A65_1, 71A65_2, or 71A65_3	1000 Probe or Pulse-Start	M47 or M141	575	24.0	15.0	24 mfd, 480V (MD2409-100)	40.0 mfd, 300V (7C400P30RA)	Series
High Pressure Sodium 60Hz CWA Ballasts								
71A80_8	100	S54	60	34.0	28.0	28.0 mfd, 300V (7C280P30RA)	6.0 mfd, 300V (7C060L30RA)	Parallel
71A81_8	150	S55	90	55.0	45.0	45 mfd, 300V (7C450P30RA)	10 mfd, 300V (7C100M30RA)	Parallel
71A82_1	250	S50	175	35.0	28.0	28 mfd, 300V (7C280P30-RA)	7 mfd, 300V (7C070L30RA)	Parallel
71A84_3	400	S51	260	55.0	40.0	40 mfd, 300V (7C400P30-RA)	15 mfd, 300V (7C150M30RA)	Parallel
71A86_5	750	S111	570	75.0	64.0	64 mfd, 280V (7C640S28RA)	11 mfd, 400V (7C110M40R)	Parallel
71A87_3	1000	S52	660	26.0	17.7	26 mfd, 525V (MD2602100)	55 mfd, 240V (7C550P24RA)	Series
71A89_1	200	S66	120	24.0	18.0	24 mfd 280V (7C240P30RA)	72 mfd 120V (7C720P12RA)	Series
71A89_1	200	S66	120	24.0	18.0	18 mfd, 400V (7C180P40R)	6 mfd 300V (7C060L30RA)	Parallel

Dry-Film Capacitors

Dimensions (in)		
Letter	Diameter	Height
L	1.18	2.2 or 2.7
M	1.58	2.7 or 3.7
P	1.77	3.7 or 4.9
S	1.97	5.0

Oil-Filled Capacitors

Dimensions (in)			
Oval	A	B	Height
1.25	1.30	2.15	As Shown in Tables
1.25	1.55	2.70	
1.75	1.90	2.90	
2.00	1.95	3.65	

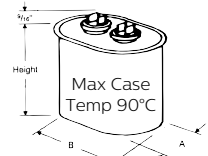
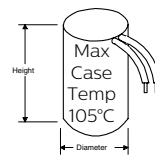

Dry-Film Capacitors Thermal Plastic Case
Dry-film capacitors contain no oil, are furnished with 8" leads and include integral resistor where required.

Oil-Filled Capacitor
Furnished with appropriate leads and/or resistors where required. Case must be grounded.

Note: Capacitor boots available, order catalog number CB-100.

Capacitor Specifications HID Non-PCB Capacitors

Mfd.	Voltage	Capacitor Part Number ²	Dia/Oval	Height	Ballast family where used
5	300	7C050L30RA	1.25	2.25	71A02x0, 5037, 5081, 5137, 78x1 (60 Hz)
6	300	7C060L30RA	1.25	2.75	71A5181, 78R1
7	300	7C070L30RA	1.25	2.75	71A1580, 50x7 (50 Hz. only), 79x1 (60 Hz)
7.5	400	7C075M40	1.50	2.90	Bi-Level, 71A5283
8	300	7C080L30RA	1.25	2.75	71A20x0, 52x0, 52x2 (60 Hz. only), 5237, 5281
8.4	300	7C084L33R	1.25	2.90	71A79x1 (50 Hz)
10	300	7C100M30RA	1.65	2.75	71A25x1 (60 Hz), 50Y1, 52Y1, 52Y2, 5337, 5340-T, 5383, 53Y3, 80x1 (60 Hz)
10	400	7C100M40R	1.40	3.75	71A55x0 (60 Hz)
11	400	7C110M40	1.65	3.75	71A55x3
12	300	7C120M30RA	1.65	2.75	71A25x1 (50 Hz), 29D1, 50x1 (50 Hz), 53x0 (60Hz, except 5340-T), 5637, 80x1 (50 Hz)
12	450	MD1204-100	1.75	2.90	71A55x0 (50 Hz)
13	525	MD1300-100	1.75	3.90	71A57E6
14	120	7C140L12RA	1.25	2.25	71A7707
14	300	7C140M30RA	1.65	2.75	71A04x0, 29R0, 52x1 (50 Hz), 52x2 (50 Hz), 5437, 5737, 81x2 (60 Hz)
15	330	7C150M33	1.65	2.75	71A56x2, 56x3
15	400	7C150P40R	1.75	3.75	71A57x0 (60 Hz), 57x1
16	300	7C160M30RA	1.65	2.75	71A05F0, 54x0, 54x2, 80x0
16	400	7C160P40	1.75	3.75	71A81x0, 07x0
16	525	MD1606-100	1.75	3.90	71A57x4, 82x0
16	525	MD1606-100	1.75	3.90	71A43x0
17	400	7C170P40	1.75	3.75	71A55x4, 5634, 57x2
17	550	MD1701-000	1.75	3.90	71A83x0
17.5	300	7C175M30RA	1.65	3.75	71A0590, 30x2, 53N0, 5837, 81x2 (50 Hz)
18	400	7C180P40R	1.75	3.75	56x3 (50 Hz), 71A57x0 (50 Hz), 89x4
20	120	7C200M12RA	1.25	2.75	71A0201, 7705, 7807
20	330	7C200P33R	1.75	3.75	71A57x2 (50 Hz), 53MO, 5880, 5937, 6037, 6137, 79x0, 81R6, 8146, 8176, 8196
20	450	MD2006-100	1.75	3.90	71A60x6
21	400	7C210P40R	1.75	4.80	71A58x2 (60 Hz)
21	525	MD2100-030	1.75	3.90	71A59x4, 60x4 (60 Hz), 6334, 64x8
22	240	7C220M24RA	1.65	2.75	71A54A3
22.5	300	7C225P30RA	1.65	3.75	71A35x2 (60 Hz), 5486, 6337
22.5	400	7C225P40	1.75	3.75	71A59x3
24	300	7C240P30RA	1.65	3.75	71A79x6, 89x1
24	400	7C240P40R	1.75	4.80	71A58x2 (50 Hz), 60x1 (60 Hz), 63x2
24	480	MD2409-000	1.75	3.90	71A84x0, 65x3 (60 Hz), 65x1
24	480	MD2409-100	1.75	3.90	71A50x0, 60N1, 65x2 (60 Hz), 65x0
25	345	7C250P34	1.75	4.80	71A59x3 (50 Hz)
26	330	7C260P33R	1.75	4.80	71A60x2 (60 Hz), 61E6
26	330	7C260S33R	2.00	4.80	Alternative to 7C260P33R
26	540	MD2602-100	1.75	5.30	71A60M2, 65x2 (50 Hz), 65x3 (50 Hz only)
26.5	400	7C265P40R	1.75	4.80	71A63x3 (60 Hz)
27.5	240	7C275P24RAT1	1.75	3.75	71A79J9
28	120	7C280M12RA	1.65	2.75	71A5005, 5105, 7805, 7907
28	300	7C280P30RA	1.75	3.75	71A35R2, 54x2 (50 Hz), 79x8, 82x6, 89x0
28	400	7C280S40	2.00	4.80	71A64x0, 64x2 (60 Hz)
28	580	MD1408-230	1.50	3.90	71A87x3 (50 Hz only, uses two 14mfd-580 volt capacitors in parallel)
30	345	7C300S34	1.75	4.80	71A60N2
32	525	MD3202-100	2.00	3.75	71A67x2 (60 Hz)
34	240	7C340P24RA	1.65	3.75	71A80x3, 71A80x8
35	240	7C350P24RA	1.65	3.75	71A54M2, 80x6, 82x1 (60 Hz)
35	300	7C350P30RA	1.65	4.75	71A40x1 (60 Hz)
36	120	7C360M12RA	1.65	2.75	71A5205, 8007, 50Y5
40	300	7C400P30RA	1.75	4.75	71A40R1, 65E6 (two in series), 82x1 (50 Hz only), 65Y6 (two in series)
45	120	7C450P12RA	1.65	2.75	71A8005
45	300	7C450P30RA	1.75	4.75	71A65M6, 83x1
48	300	7C480P30RA	1.75	4.75	71A84x6, 85x6
52	240	7C520P24RA	1.75	3.75	71A8156, 81E6
52	280	7C520S28RA	2.00	4.00	Bi-Level
55	120	7C550P12RA	1.65	3.75	71A8107
55	240	7C550P24RA	1.75	3.75	71A81x8, 84x3 (60 Hz)
58	240	7C580P24RA	1.75	3.75	71A8593
60	240	7C600P24RA	1.75	3.75	71A99x2, 71A9968
64	280	7C640S28RA	2.00	5.00	71A84x3 (50 Hz), 85x5
66	280	7C660S28RA	2.00	5.00	71A9942, 71A9943
75	280	7C750S28RA	2.00	5.00	71A86x5

1. "R" suffix denotes capacitors with a discharge resistor where required by UL.

2. MD_ denotes 90° Oil Filled, 7C_ denotes 105° Dry Film with leads.

Ballasts-to-Lamp Remote Mounting Distances

Ignitors

Ballasts that include an ignitor to start the HID lamp are limited in the distance which they may be mounted remotely from the lamp because the ignitor pulse attenuates as the wire length between the ballast and lamp increases. All Philips Advance open core & coil ballasts listed in this Atlas include a **standard ignitor** that provides the proper electrical pulse to start lamps when the ballast is mounted **within** the lighting fixture. For most of these ballast/ignitor combinations, the maximum ballast-to-lamp distance is listed as 2 feet. For ballast-to-lamp distances greater than the capability of the standard ignitor, a **long-range ignitor** is required.

Use the tables on the following pages to find the proper long range ignitor for various metal halide and high pressure sodium ballasts. Not all ballasts listed in the Atlas have long-range ignitor options. It may be necessary to use a ballast employing a different circuit to achieve the needed ballast-to-lamp distance.

Whichever ignitor is used, it must be installed with and adjacent to the core & coil, as the two components work together to deliver the proper pulse to the lamp. When remote mounting the ballast away from the lamp, the ignitor must be located next to the ballast and not next to the remote lamp in order to utilize the full ballast to lamp distance range. If the ignitor is located next to the remote lamp, the usable ballast to lamp remote mounting distance will be cut in half.

Metal Halide Ballasts

The distances at which most metal halide ballasts can be located from their respective lamps are limited by the ballast-to-lamp wire size. The exceptions being the ballasts for the new lamps that require an ignitor for starting. The mounting distances for these are limited by the ignitor as shown on the following page.

Use this chart to determine the minimum wire size required for the metal halide (not requiring an ignitor) lamps shown:

Lamp		Maximum One-Way Length of Wire between Lamp and Ballast (ft) (Voltage Drop Limited to 1% of Lamp Voltage)				
Wattage	Metal Halide	#10	#12	#14	#16	#18
175	M57	425	265	165	105	65
250	M58	300	190	120	75	45
1-400 or 2-400	M59	200	125	75	50	30
1000	M47	325	205	125	80	50
1500	M48	225	140	85	55	35

Ignitor Specifications (Case Temperature Rating 105°C)



Metal Halide

Metal Halide							Long Range Ignitor			
Ballast Data				Standard Ignitor			Catalog Number	Min. Dist. (ft) To Lamp	Max. Dist. (ft) To Lamp	Case Type
Philips Advance Ballast Family	Lamp Watts	ANSI Code	Ballast Circuit Type	Catalog Number	Max. Dist. (ft.) To Lamp	Case Type				
71A5005	35	M130	HX	LI533-H4-IC	15	Round	XTENZA® Long-Range Ignitor - Meets ANSI pulse requirements for all ballast to lamp distances from 0 to 50 ft. - Features 105°C case temperature rating - See Ordering Information below LI533-LR1 0 - 50 ft Oval  LI533-LR 0 - 50 ft Oval LI533-LR3★ 0 - 50 ft Oval			
71A5105	50	M110/148	HX	LI533-H4-IC	15	Round				
71A51_1	50	M110/148	HX	LI533-H4-IC	10	Round				
71A5137	50	M110/148	R	LI533-H4-IC	2	Round				
71A5205	70	M98/143	HX	LI533-H4-IC	25	Round				
71A52_2	70	M98/143	HX	LI533-H4-IC	15	Round				
71A5237	70	M98/143	R	LI533-H4-IC	10	Round				
71A52_1	70	M139	HX	LI533-H4-IC	10	Round				
71A53_0	100	M90/140	HX	LI533-H4-IC	20	Round				
71A5383	100	M90/140	CWA	LI533-H4-IC	2	Round				
71A5337	100	M90/140	R	LI533-H4-IC	2	Round				
71A54_2	150	M102/142	HX	LI533-H4-IC	10	Round				
71A5437	150	M102/142	R	LI533-H4-IC	2	Round				
71A55_3	175	M137/152	SuperCWA	LI533-H4-IC	2	Oval				
71A56_2	200	M136	SuperCWA	LI533-H4-IC	2	Round				
71A56_3	200	M136	SuperCWA	LI533-H4-IC	5	Round				
71A57_2	250	M138/153	SuperCWA	LI533-H4-IC	5	Round				
71A58_2	320	M132/154	SuperCWA	LI533-H4-IC	2	Round				
71A59_3	350	M131	SuperCWA	LI533-H4-IC	2	Round				
71A60_2	400	M135/155	SuperCWA	LI533-H4-IC	10	Round				
71A61E6	400	M135/155	SuperCWI	LI533-H4-IC	2	Round				
71A63_3	450	M144	SuperCWA	LI533-H4-IC	5	Round				
71A64_0	750	M149	SuperCWA	LI573-H5-IC	15	Oval				
71A64_2	750	M149	SuperCWA	LI573-H5-IC	15	Oval				
71A64_8	875	M-166	SuperCWA	LI572-H5-IC★	10	Oval				
71A65_1	1000	M141	SuperCWA	LI572-H5-IC★	10	Oval				
71A65_3	1000	M141	SuperCWA	LI571-H5-IC★	5	Oval				
71A50_5	35	M130	HX	LI533-H4-IC	15	Round	LI561-H5★	15	50	Oval
71A5081	35	M130	HX	LI533-H4-IC	15	Round	LI561-H5★	15	50	Oval
71A5037	35	M130	R	LI533-H4-IC	10	Round	LI561-H5★	10	50	Oval
71A52_0	70	M85	HX	LI522-H5-IC★	30	Oval	Not Available			
71A54A3	150	M102/142	SuperCWA	LI501-J4-IC★	15	Round	Not Available			
71A54_0	150	M81	HX	LI522-H5-IC★	20	Oval	Not Available			
71A5486	150	M81	CWA	LI523-H5-IC★	2	Oval	Not Available			
71A5880	250	M80	HX	LI522-H5-IC★	5	Oval	Not Available			
71A86_5	750	**	CWA	LI561-H5-IC★	5	Oval	Not Available			

★ Equipped with an auto-rest thermal protector to help prevent ignitor from overheating in the event of lamp failure.

XTENZA Ordering Information

To order in bulk, specify item no. LI533-LR, LI533-LR1 or LI533-LR3. For individual carton, add -IC to item no.

XTENZA is also available packaged with the ballasts shown at right.

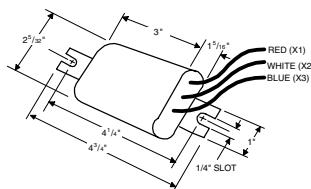

Oval Case

Lamp Watts	ANSI Code	Ballast Number	No Bracket	With Welded Bracket
70	M98/143	71A5292	-900D	
100	M90/140	71A5390	-900D	

Round Case

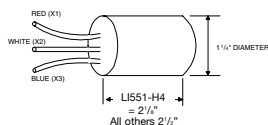

RW33CC1252 MOUNTING CLIP for Round Case (Furnished as standard with -001 suffix ballasts and all -IC suffix replacement ignitors.)

LISOD

The Philips Advance shut-off device (LISOD) enhances the reliability of High Intensity Discharge (HID) lighting systems where ignitors are utilized to start the HID lamps. This includes all high pressure sodium lamps as well as all low, medium and high wattage pulse-start metal halide lamps. The LISOD shut-off device is used in addition to a standard ignitor.

The LISOD shut-off device increases the life of the ignitor by disabling it from the circuit and eliminating any concern over long-term ballast reliability due to continuously pulsing ignitors when a lamp is burned out. The LISOD provides a simple solution to eliminate lamp cycling typically associated with lamps that have reached their end-of-life. The LISOD disables the ignitor after 15 minutes of pulsing in cases when lamp is taken out of socket or lamp fails to ignite.

- Compatible with any Philips Advance Reactor (R), High-Reactance (HX) and Constant Wattage Autotransformer (CWA) ballast and ignitor circuit that includes a 120V input tap
- Integral timer automatically disables ignitor from ballast circuit 15-minutes after power is applied to the ballast
- Extends ignitor life, which is typically rated for 10,000 hours of continuous pulsing
- Protects ballast coil insulation from potential damage due to a continuously pulsing ignitor
- Prevents cycling of end-of-life lamps making identification for lamp replacement easy
- Automatically resets/restarts itself after 0.6 second of power interruption (voltage dropout)

Catalog Number	Description	Quantity Per Carton
LISOD1-IC	Ignitor shut-off device for HID CWA, HX and R ballasts with ignitors. Individual carton packaging	1
LISOD1	Ignitor shut-off device for HID CWA, HX and R ballasts with ignitors. Bulk packaging	50

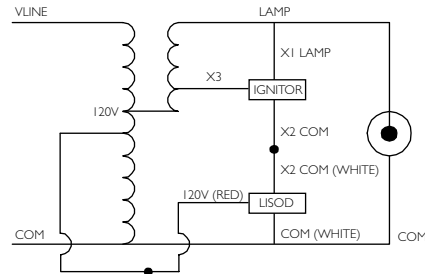
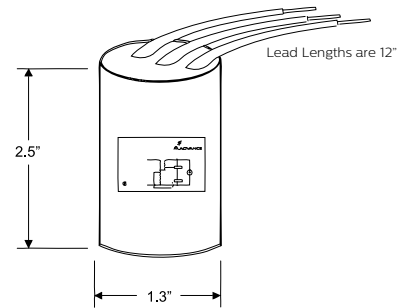

Ignitor Specifications (Case Temperature Rating 105°C)

High Pressure Sodium



High Pressure Sodium									
Ballast Data				Standard Ignitor			Long Range Ignitor		
Philips Advance Ballast Family	Lamp Watts	ANSI Code	Ballast Circuit Type	Catalog Number	Max. Dist. (ft.) To Lamp	Case Type	Catalog Number	Max. Dist. (ft.) To Lamp	Case Type
71A7707	35	S76	R	LI551-H4-IC	2	Round	LI551-J4-IC	15	Round
71A7801	50	S68	HX	LI551-H4-IC	2	Round	LI551-J4-IC	35	Round
71A7807	50	S68	R	LI551-H4-IC	2	Round	LI551-J4-IC	15	Round
71A79_1	70	S62	HX	LI551-H4-IC	2	Round	LI551-J4-IC	35	Round
71A79_6	70	S62	CWI	LI551-J4-IC	2	Round	Not Available		
71A79_8	70	S62	CWA	LI551-J4-IC	5	Round	Not Available		
71A7907	70	S62	R	LI551-H4-IC	2	Round	LI551-J4-IC	15	Round
71A80_1	100	S54	HX	LI551-H4-IC	2	Round	LI551-J4-IC	35	Round
71A80_8	100	S54	CWA	LI551-J4-IC	5	Round	Not Available		
71A8007	100	S54	R	LI551-H4-IC	2	Round	LI551-J4-IC	15	Round
71A80_6	100	S54	CWI	LI551-J4-IC	2	Round	Not Available		
71A81_2	150	S55	HX	LI551-H4-IC	2	Round	LI551-J4-IC	35	Round
71A81_8	150	S55	CWA	LI551-J4-IC	10	Round	Not Available		
71A8107	150	S55	R	LI551-H4-IC	2	Round	LI551-J4-IC	15	Round
71A8156	150	S55	CWI	LI551-J4-IC	2	Round	Not Available		
71A85_5	150	S55	CWI	LI551-J4-IC	2	Round	Not Available		
71A81_6	150	S56	CWA	LI501-H4-IC	2	Round	LI501-J4-IC	50	Round
71A86_7	150	S56	R	LI501-H4-IC	2	Round	LI501-J4-IC	50	Round

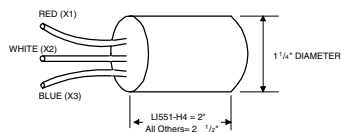

Round Case

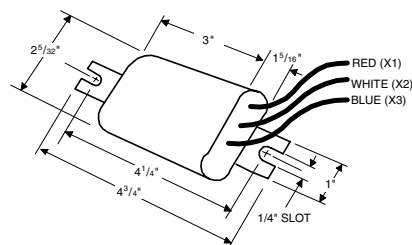

Oval Case

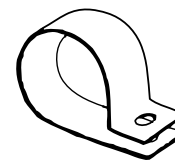

RW33CC1252
Mounting Clip for Round Case
(Furnished as standard with -001 suffix ballasts and all -IC suffix replacement ignitors.)

Ignitor Specifications (Case Temperature Rating 105°C)



High Pressure Sodium

High Pressure Sodium									
Ballast Data				Standard Ignitor			Long Range Ignitor		
Philips Advance Ballast Family	Lamp Watts	ANSI Code	Ballast Circuit Type	Catalog Number	Max. Dist. (ft.) To Lamp	Case Type	Catalog Number	Max. Dist. (ft.) To Lamp	Case Type
71A89_0	200	S66	CWA	LI501-H4-IC	2	Round	LI501-J4-IC	50	Round
71A89_1	200	S66	CWA	LI501-H4-IC	2	Round	LI501-J4-IC	50	Round
71A89_7	200	S66	R	LI501-H4-IC	2	Round	LI501-J4-IC	50	Round
71A82_1	250	S50	CWA	LI501-H4-IC	2	Round	LI501-J4-IC	50	Round
71A82_6	250	S50	CWI	LI501-J4-IC	2	Round	Not Available		
71A82_7	250	S50	R	LI501-H4-IC	2	Round	LI501-J4-IC	50	Round
71A8392	250	S50	CWA	LI501-H4-IC	2	Round	LI501-J4-IC	50	Round
71A83_1	310	S67	CWA	LI501-H4-IC	2	Round	LI501-J4-IC	50	Round
71A83_7	310	S67	R	LI501-H4-IC	2	Round	LI501-J4-IC	50	Round
71A84_3	400	S51	CWA	LI501-H4-IC	2	Round	LI501-J4-IC	50	Round
71A84_6	400	S51	CWI	LI501-J4-IC	2	Round	Not Available		
71A84_7	400	S51	R	LI501-H4-IC	2	Round	LI501-J4-IC	50	Round
71A85_6	430	n/a	CWI	LI501-H4-IC	15	Round	LI501-J4-IC	35	Round
71A85_5	600	S106	CWA	LI561-H5-IC	5	Oval	Not Available		
71A85_8	600	S106	CWI	LI561-H5-IC	2	Oval	Not Available		
71A86_5	750	S111	CWA	LI561-H5-IC	5	Oval	Not Available		
71A87_3	1000	S52	CWA	LI571-H5-IC★	15	Oval	LI571-J5-IC★	75	Oval

★ Equipped with an auto-rest thermal protector to help prevent ignitor from overheating in the event of lamp failure.

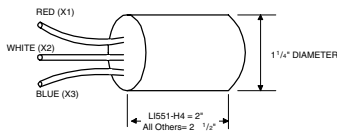

Round Case

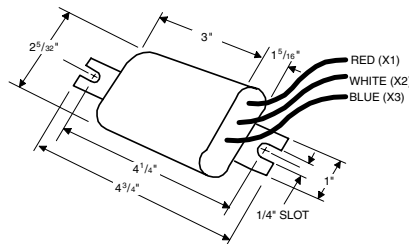







Oval Case



RW33CC1252
Mounting Clip for Round Case
(Furnished as standard with -001 suffix ballasts and all -IC suffix replacement ignitors.)

Transformers and Autotransformers

Stepdown Transformers and Autotransformers

Lamp Type	Lamp Watts	Input: Output (Volts)	Catalog † Number	Max. Input Current	Max. Input Watts	Max. V.A. Load	Wiring Diagram	Dimensions			Weight (lbs)
								Fig	A	B	
RoHS COMPLIANT  											
Stepdown Transformers for 6 and 12V Halogen Lighting											
Halogen	75	120:11.5	71A9743-600C	.8	81	75	T-1	9	1.5	2.8	2.5
	50/75	277:11.8	71A9833-600C	.3/.4	60/86	75	T-1	9	1.5	2.8	2.5
RoHS COMPLIANT  											
Stepdown Autotransformers for 120V Incandescent Lighting											
Incandescent	150	277:115	71A9749-600	.6	150	150	T-2	9	1.5	2.7	2.3
	200		71A9839-600 (-J)	.8	199	200	T-2	9 (11)	2.2	3.8(4.2)	3.8(4.1)
	300		71A9741-600 (-J)	1.1	300	300	T-2	9 (11)	2.0	3.5(4.0)	3.5(3.8)
RoHS COMPLIANT  											
Stepdown & Step-up Autotransformers for use with HID Reactor Ballasts											
High Pressure Sodium	100/150	347:120/277	71A9862-600	1.7	200	395	T-2	9	2.7	3.9	4.5
Metal Halide	70	120:277	71A9900-600	2.5	85	250	T-4	9	1.9	3.4	3.3
	100/150		71A9741-600 (-J)	2.4	125	300	T-4	9 (11)	2.0	3.5(4.0)	3.5(3.8)
	50/100/150	347:120/277	71A9862-600 (-J)	1.7	200	395	T-2	9 (11)	2.7	3.9(4.7)	4.5(4.8)
LED*	150	480:270 or 347:190	71A9843-600	0.65	100	350	T-2	9	2.4	3.8	3.7
eHID**	210	480:270	71A9843-600	0.47	227	350	T-2	9	2.4	3.8	3.7
	315	480:270	71A9843-600	0.72	346	350	T-2	9	2.4	3.8	3.7

† Ordering information:

Add proper suffix to catalog number:

-600 includes core and coil only.

-J (available where shown) includes J-Box cover and auto-reset thermal protection. Refer to Figure 11.

* For use with Intellivolt LED drivers

** For use with MasterColor MW ballast: IZTMH-210315-R-LF

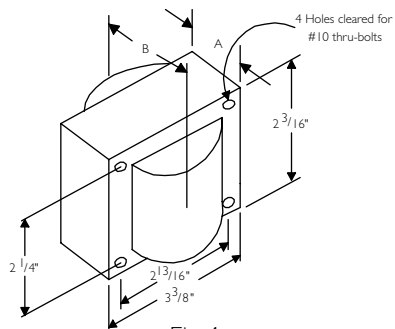

Fig 4
(2³/₁₆" x 3³/₈" Reactor Core)

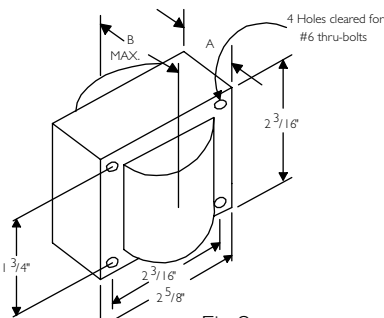

Fig 9
(2⁵/₈" x 2³/₁₆" Reactor Core)

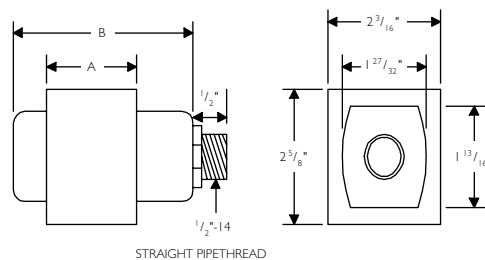

Fig 11
(J-Box Ballast)

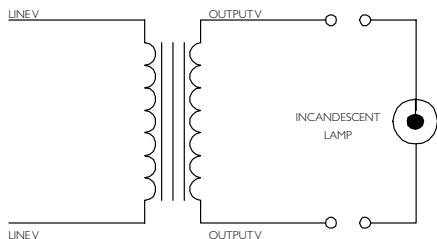

Fig T-1

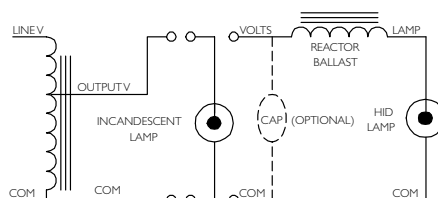

Fig T-2

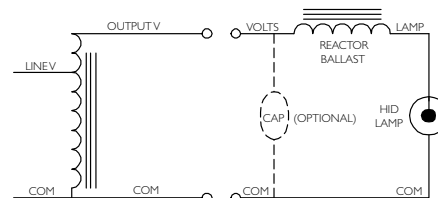

Fig T-4

60 Hz F-Can Ballasts (Indoor, Outdoor Type 1)

Metal Halide

Input Voltage	Catalog Number	Circuit Type	Input Amps			Input Watts	Nom. Open Circuit Voltage	Fuse Rating Amps	Over-all Length	Case Length	Mtg. Dim.	Total Wt. (lbs)	Max. Ballast to Lamp Distance (ft)	Certifications		
			Operating	Starting	Open Circuit									UL	SF	RoHS COMPLIANT
35/39W Lamp, ANSI Code M130 (Pulse Start)												SOUND RATING B				
120/277	72C5081-NP	HX-HPF	.6/.3	.6/.3	1.0/.4	56	255	3/1	11.75	10.50	11.13	9.0	10	✓	✓	✓
50W Lamp, ANSI Code M110 or M148 (Pulse Start)												SOUND RATING B				
120/277	72C5181-NP 72C5181-NP-001	HX-HPF	.7/.3	.8/.4	1.2/.5	72	254	3/2	11.75	10.50	11.13	9.0	10	✓	✓	✓
70W Lamp, ANSI Code M85 (Double-ended lamp) (Pulse Start)												SOUND RATING B				
120/277	72C5280-NP-001	HX-HPF	.9/.4	1.0/.5	1.7/.8	94	240	5/2	11.75	10.50	11.13	8.5	10	✓	✓	✓
70W Lamp, ANSI Code M98 or M143 (Pulse Start)												SOUND RATING B				
120/277	72C5282-NP 72C5282-NP-001 72C5282-NP-900*	HX-HPF	.9/.4	1.3/.6	1.6/.8	94	255	4/2	11.75	10.50	11.13	8.5	10	✓	✓	✓
								50					✓	✓		
120/347	72C52C2-NP							.9/.3					1.2/.4	1.7/.7	5/2	20
70W Lamp, ANSI Code M139 (Pulse Start)												SOUND RATING B				
120/277	72C5281-NP-900*	HX-HPF	.9/.4	1.0/.5	1.7/.8	94	240	5/2	11.75	10.50	11.13	8.5	50	✓	✓	✓
100W Lamp, ANSI Code M90 or M140 (Pulse Start)												SOUND RATING B				
120/277	72C5381-NP 72C5381-NP-001 72C5381-NP-900*	HX-HPF	1.1/.5	2.2/1.0	2.4/1.1	125	277	6/3	11.75	10.50	11.13	11.0	5	✓	✓	✓
								50					✓	✓		
120/347	72C53C1-NP							1.1/.4					2.2/.8	2.4/.9	6/2	15
150W Lamp, ANSI Code M81 (Double-ended lamp) (Pulse Start)												SOUND RATING B				
120/277	72C5481-NP	HX-HPF	1.6/.7	1.7/.8	3.7/1.6	180	240	10/4	14.30	13.13	13.75	13.0	10	✓	✓	✓
150W Lamp, ANSI Code M102 or M142 (Pulse Start)												SOUND RATING B				
120/277	72C5482-NP 72C5482-NP-900*	HX-HPF	1.6/.7	1.5/.8	3.7/1.6	180	277	10/4	14.30	13.13	13.75	13.0	5	✓	✓	✓
120/347	72C54C2-NP-900*												1.6/.6	1.7/.6	3.7/1.3	180

All Philips Advance dual-volt, F-can ballasts include auto-reset thermal protection for both taps.

Replacement ballasts in individual cartons indicated by bold type with suffix -001.

- Ballasts with suffix -900 include integral XTENXA Long-Range Ignitor for 50ft. max. ballast to lamp distance. Also suitable for shorter distances.
- * All 150W thru 400W F-Can Ballasts are not EISA compliant.

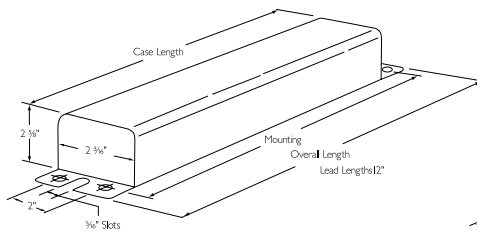

Dimensions

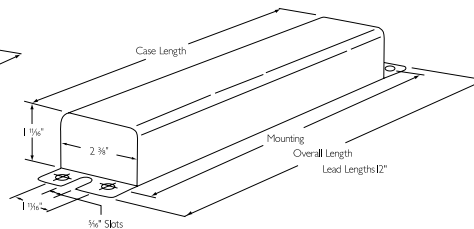

Dimensions
(72C5005-NP)

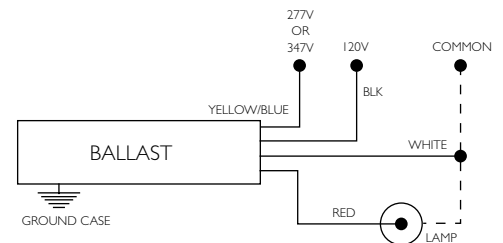

Wiring Diagram
All lead lengths 12"

60 Hz F-Can Ballasts (Indoor, Outdoor Type 1)

Metal Halide

Input Voltage	Catalog Number	Circuit Type	Input Amps			Input Watts	Nom. Open Circuit Voltage	Fuse Rating Amps	Over-all Length	Case Length	Mtg. Dim.	Total Wt. (lbs)	Max. Ballast to Lamp Distance (ft)	Certifications		
			Operating	Starting	Open Circuit									UL	SF	RoHS COMPLIANT
175/150W Lamp, ANSI Code M57 or M107 or 145W Lamp, ANSI Code C192 (Philips AllStart)**													SOUND RATING C			
120/277	72C5581-NP-001	CWA	2.0/.9	2.0/.9	1.4/.7	205	300	5/3	11.75	10.50	11.13	12.0	⊕	✓	✓	✓
120/347	72C55C1-NP		1.9/.7	1.9/.7	1.7/.5	208		5/2							✓	✓
175W Lamp, ANSI Code M137 or M152 (Pulse Start) or 145W Lamp, ANSI Code C192 (Philips AllStart)**													SOUND RATING B			
120/277	72C5582-NP	Super CWA	1.7/.8	.9/.4	2.2/.9	205	300	5/3	14.30	13.13	13.75	15.5	50	✓	✓	✓
250W Lamp, ANSI Code M58 or 205W Lamp, ANSI Code C184 (Philips AllStart)***													SOUND RATING C			
120/277	72C5782-NP-001	CWA	2.6/1.1	2.1/.9	2.1/.9	290	300	8/4	16.70	15.50	16.13	16.0	⊕	✓	✓	✓
120/347	72C57C2-NP		2.5/.9	2.0/.7	2.0/.7			7/3	14.30	13.13	13.75				14.0	✓
250W Lamp, ANSI Code M138 or M153 (Pulse Start) or 205W Lamp, ANSI Code C184 (Philips AllStart)*** (Pulse Start)													SOUND RATING B			
120/277	72C5783-NP	Super CWA	2.8/1.2	2.5/1.1	1.9/.8	290	300	8/3	16.70	15.50	16.13	18.0	50	✓	✓	✓
320W Lamp, ANSI Code M132 or M154 (Pulse Start)													SOUND RATING C			
120/277	72C5882-NP	Super CWA	3.4/1.5	2.8/1.2	1.6/.7	370	270	8/3	19.20	18.00	18.63	21.0	50	✓	✓	✓
400W Lamp, ANSI Code M59 or 330W Lamp, ANSI Code C185 (Philips AllStart)****													SOUND RATING C			
120/277	72C6082-NP-001	CWA	3.9/1.7	3.3/1.4	3.9/1.7	460	310	10/5	19.20	18.00	18.63	22.5	⊕	✓	✓	✓
400W Lamp, ANSI Code M135 or M155 (Pulse Start) or 330W Lamp, ANSI Code C185 (Philips AllStart)****													SOUND RATING C			
120/277	72C6182-NP	Super CWA	4.1/1.8	2.9/1.3	3.9/1.7	465	310	10/4	19.20	18.00	18.63	24.0	50	✓	✓	✓

All Philips Advance dual-volt, F-can ballasts include auto-reset thermal protection for both taps.

⊕ Ballast to lamp distance is only limited by the size of the conductor between the ballast and the lamp. For proper wire size, see table on page 7-40 of this catalog.

Replacement ballasts in individual cartons indicated by bold type with suffix -001.

* All 150W thru 400W F-Can Ballasts are not EISA compliant.

** The 145 Watt Lamp, ANSI Code C192, is an energy saving, screw in replacement lamp for the M57 or M152 lamps that may reduce input watts up to 15% on existing 175W ballasts.

*** The 205 Watt Lamp, ANSI Code C184 is an energy saving, screw in replacement lamp for the M58 or M138 and M153 PS lamps that may reduce input watts up to 18% on existing ballasts.

**** The 330 Watt Lamp, ANSI Code C185 is an energy saving, screw in replacement lamp for the M59 or M135 and M155 PS lamps that may reduce input watts up to 18% on existing ballasts.

Accessories

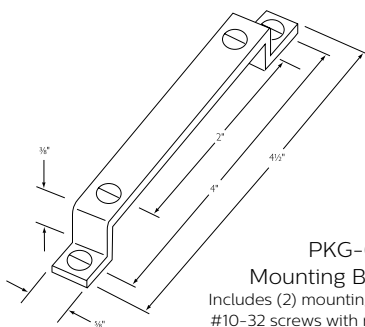

PKG-625
Mounting Bracket Kit
Includes (2) mounting brackets and (4) #10-32 screws with nuts and washers.

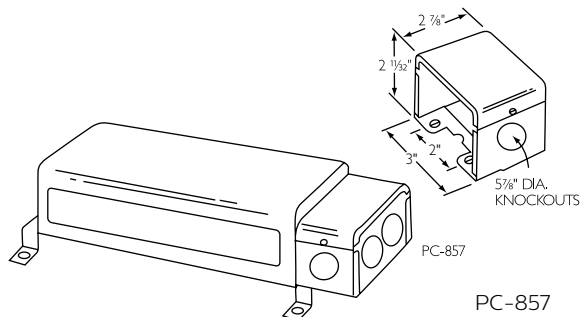

PC-857
Wiring Compartment
For end mounting, includes (5) 7/8" dia. knockouts. May be used with or without PC-625 Mtg. Brkt. Kit.

60 Hz F-Can Ballasts (Indoor, Outdoor Type 1)

High Pressure Sodium

Input Voltage	Catalog Number	Circuit Type	Input Amps			Input Watts	Nom. Open Circuit Voltage	Fuse Rating Amps	Over-all Length	Case Length	Mtg. Dim.	Total Wt. (lbs)	Max. Ballast to Lamp Distance (ft)	Certifications		
			Operating	Starting	Open Circuit									UL	SP	RoHS COMPLIANT
50W Lamp, ANSI Code S68																
120/277	72C7884-NP-001	HX-HPF	.7/.3	.7/.4	1.4/.7	65	120	4/2	11.75	10.50	11.13	11.0	15	✓	✓	✓
70W Lamp, ANSI Code S62																
120/277	72C7984-NP	HX-HPF	.9/.4	1.0/.5	1.4/.7	90	120	5/2	11.75	10.50	11.13	10.0	7	✓	✓	✓
120/347	72C79C4-NP							.8/.3						.9/.3	1.4/.5	94
100W Lamp, ANSI Code S54 SOUND RATING B																
120/277	72C8084-NP	HX-HPF	1.1/.5	1.5/.7	1.9/.8	125	120	6/3	11.75	10.50	11.13	11.0	15	✓	✓	✓
	72C8084-NP-001													✓	✓	✓
150W Lamp, ANSI Code S55 (55V Arc Tube) SOUND RATING B																
120/277	72C8185-NP	HX-HPF	1.7/.7	2.6/1.2	2.2/1.0	185	120	8/4	14.30	13.13	13.75	14.0	5	✓	✓	✓

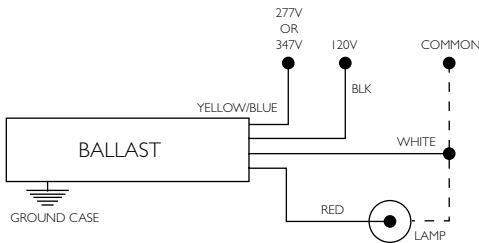

Wiring Diagram
All lead lengths 12"

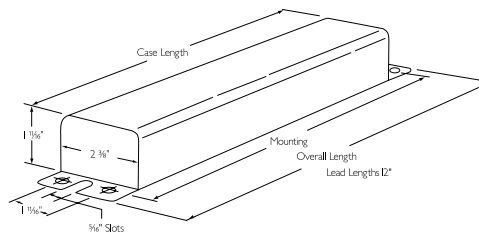

Dimensions

Accessories

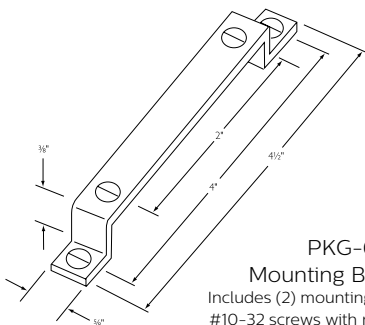

PKG-625
Mounting Bracket Kit
Includes (2) mounting brackets and (4)
#10-32 screws with nuts and washers.

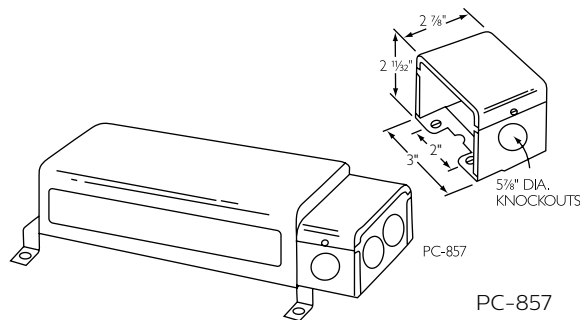

PC-857

PC-857
Wiring Compartment
For end mounting, includes
(5) 7/8" dia. knockouts. May be
used with or without PC-625
Mtg. Brkt. Kit.

60 Hz Encapsulated Core & Coil Ballasts

Metal Halide



Input Volts	Catalog † Number	Circuit Type	Input Watts	Max* Input Current	Nom Open Circuit Voltage	Fuse Rating (Amps)	Wiring Dia	Case Style	Non-PCB Capacitor (Page 7-37 & 7-38)				Total Weight (lbs)	Ignitor †† (Page 7-39 to 7-43)	
									Mfd	Min Volt	Cap Catalog Number	Dry or Oil		Part Number	Max Dist To Lamp (ft)
70W Lamp, ANSI Code M98 (Pulse Start)												SOUND RATING A			
120/277	73B5282-500D	HX-HPF	90	1.9/.8	255	4/2	K	PC709-2	8	280	7C080L30RA	D	9.0	LI533-H4	15
100W Lamp, ANSI Code M90 or M140 (Pulse Start)												SOUND RATING A			
120/277	73B5383-500D	CWA	128	1.1/.5	235	3/2	M	PC709-4	10	300	7C100M30RA	D	10.0	LI533-H4	2
150W Lamp, ANSI Code M102 or M142 (Pulse Start)												SOUND RATING A			
120/277	73B5482-500D	HX-HPF	185	3.7/1.6	265	10/4	K	PC709-4	16	280	7C160M30RA	D	11.0	LI533-H4	10
175W Lamp, ANSI Code M57 or 145W Lamp, ANSI Code C192 (Philips AllStart)**												SOUND RATING A			
120/208/240/277	73B5590-500D	CWA	210	1.8/1.1/.9/.8	280	5/3/3/2	A	PC709-4	10	400	7C100M40-R	D	12.0	-	-
175W Lamp, ANSI Code M137 or M152 (Pulse Start) or 145W Lamp, ANSI Code C192 (Philips AllStart)**												SOUND RATING A			
ⓔ 120/208/240/277	73B5591-500DEE	Super CWA	198	1.7/1.0/.8/.7	285	5/3/3/2	M	PC767-1	11	370	7C110M40	D	15.0	LI533-H4	2
250W Lamp, ANSI Code M138 or M153 (Pulse Start) or 205W Lamp, ANSI Code C184 (Philips AllStart)***												SOUND RATING B			
ⓔ 120/208/240/277	73B5792-500DEE	Super CWA	283	2.5/1.5/1.3/1.1	275	8/5/5/3	M	PC767-1	17	350	7C170P40	D	16.0	LI533-H4	2
250W Lamp, ANSI Code M58 or 205W Lamp, ANSI Code C184 (Philips AllStart)***												SOUND RATING B			
120/208/240/277	73B5790-500DA	CWA	295	2.5/1.4/1.3/1.1	300	8/5/5/3	A	PC767-1	15	400	7C150P40-R	D	15.0	-	-
320W Lamp, ANSI Code M132 or M154 (Pulse Start)												SOUND RATING B			
ⓔ 120/208/240/277	73B5892-500DAEE	Super CWA	363	3.3/1.9/1.7/1.4	270	8/6/5/3	M	PC767-3	21	345	7C210P40R	D	18.0	LI533-H4	2

† **Ordering information:**

Original equipment ballasts – typically ordered with capacitor (as shown)

-500D includes core & coil with dry-film capacitor

May also be available without capacitor:

-600 core & coil only (no capacitor)

• For CWA, figure is operating current. For HX circuits, figure is highest of starting, operating or open circuit currents.

†† Each ballast requiring an ignitor is furnished standard with the **short-range** ignitor model shown for use within fixtures. Long-range ignitors are available separately, if required. See pages 7-39 to 7-43 for additional information.

ⓔ Indicates the ballast meets the 88% efficiency requirements of EISA (Energy Independence and Security Act of 2007)

** The 145 Watt Lamp, ANSI Code C192, is an energy saving, screw in replacement lamp for the M57 or M152 lamps that may reduce input watts up to 15% on existing 175W ballasts.

*** The 205 Watt Lamp, ANSI Code C184 is an energy saving, screw in replacement lamp for the M58 or M138 and M153 PS lamps that may reduce input watts up to 18% on existing ballasts.

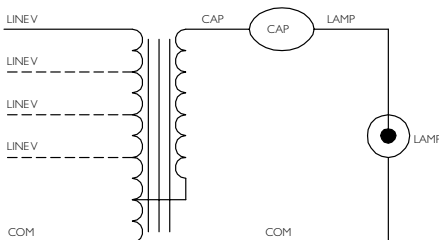

Fig. A

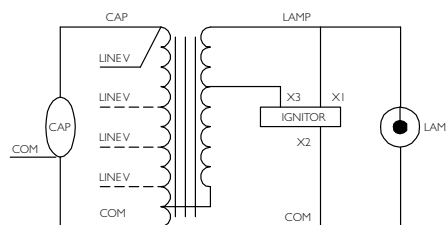

Fig. K

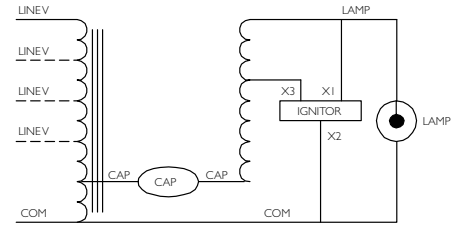

Fig. M

60 Hz Encapsulated Core & Coil Ballasts

Metal Halide



Input Volts	Catalog † Number	Circuit Type	Input Watts	Max Input Current	Nom Open Circuit Voltage	Fuse Rating (Amps)	Wiring Dia	Case Style	Non-PCB Capacitor (Page 7-37 & 7-38)				Total Weight (lbs)	Ignitor †† (Page 7-39 to 7-43)	
									Mfd	Min Volt	Cap Catalog Number	Dry or Oil		Part Number	Max Dist To Lamp (ft)
400W Lamp, ANSI Code M59 or 330W Lamp, ANSI Code C185 (Philips AllStart)**												SOUND RATING B			
120/208/240/277	73B6091-500DA	CWA	458	4.0/2.3/2.0/1.7	305	10/7/5/5	A	PC767-3	24	400	7C240P40-R	D	20.0	-	-
400W Lamp, ANSI Code M135 or M155 (Pulse Start) or 330W Lamps, ANSI Code C185 (Philips AllStart)**												SOUND RATING B			
120/208/240/277	73B6092-500DAEE	Super CWA	454	3.8/2.2/1.9/1.7	270	10/7/5/5	M	PC767-3	26	330	7C260P33R	D	15.0	L1533-H4	2
1000W Lamp, ANSI Code M47												SOUND RATING C			
120/208/240/277	73B6590-500	CWA	1070	9.0/5.2/4.5/3.9	415	20/15/10/10	A	PC768-2	24	480	MD2409-100	O	28.0	-	-
120/277/347	73B65A2-500	CWA	1080	9.0/3.9/3.2	430	20/10/8	A	PC768-1	24	480	MD2409-100	O	28.0	-	-
1000W Lamp, ANSI Code M141 (Pulse Start)												SOUND RATING C			
120/208/240/277	73B6593-500	Super CWA	1080	9/5.3/4.5/3.9	430	20/15/10/10	M	PC768-1	24	480	MD2409-000	O	29.0	L1571-H5	5

DIMENSIONS

Case Style	Lead Exit	A	B	C	D	E	F
PC709-2	Side	4.6	3.4	3.6	2.0	5.25	6.0
PC709-4	Side	4.6	4.4	3.6	2.0	5.25	6.0
PC767-1	Side	5.4	5.0	3.8	2.0	6.0	6.75
PC767-3	Side	5.4	5.0	4.3	2.0	6.0	6.75
PC768-1	Side	6.5	5.0	5.2	2.0	7.0	7.75
PC768-2	Side	6.5	5.0	5.9	2.0	7.0	7.75

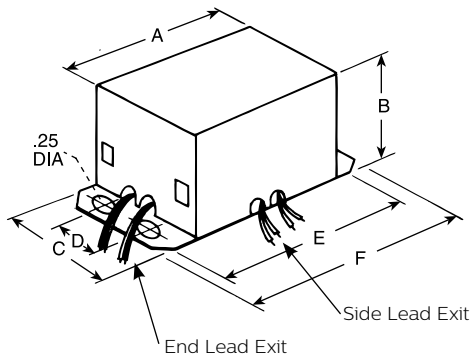

60 Hz Encapsulated Core & Coil Ballasts

High Pressure Sodium



Input Volts	Catalog † Number	Circuit Type	Input Watts	Max* Input Current	Nom Open Circuit Voltage	Fuse Rating (Amps)	Wiring Dia	Case Style	Non-PCB Capacitor (Page 7-37 & 7-38)				Total Weight (lbs)	Ignitor †† (Page 7-39 to 7-43)	
									Mfd	Min Volt	Cap Catalog Number	Dry or Oil		Part Number	Max Dist To Lamp (ft)
250W Lamp, ANSI Code S50												SOUND RATING B			
120/208/240/277	73B8291-500DA	CWA	295	2.5/1.5/1.3/1.1	187	7/4/4/3	M	PC767-3	35	240	7C350P24RA	D	15.4	LI501-H4	2
400W Lamp, ANSI Code S51												SOUND RATING B			
120/208/240/277	73B8493-500D	CWA	460	3.8/2.2/1.9/1.7	190	10/8/5/5	M	PC767-3	55	240	7C550P24RA	D	21.0	LI501-H4	2

† **Ordering information:**

Original equipment ballasts – typically ordered with capacitor (as shown)

-500D includes core & coil with dry-film capacitor

May also be available without capacitor:

-600 core & coil only (no capacitor)

• For CWA, figure is operating current. For HX circuits, figure is highest of starting, operating or open circuit currents.

†† Each ballast requiring an ignitor is furnished standard with the short-range ignitor model shown for use within fixtures. Long-range ignitors are available separately, if required. See pages 7-39 to 7-43 for additional information.

Ⓔ Indicates the ballast meets the 88% efficiency requirements of EISA (Energy Independence and Security Act of 2007).

** The 145 Watt Lamp, ANSI Code C192 is an energy saving, screw in replacement lamp for the M57 or M152 lamps that may reduce input watts up to 15% on existing 175W ballasts.

*** The 205 Watt Lamp, ANSI Code C184 is an energy saving, screw in replacement lamp for the M58 or M138 and M153 PS lamps that may reduce input watts up to 18% on existing ballasts.

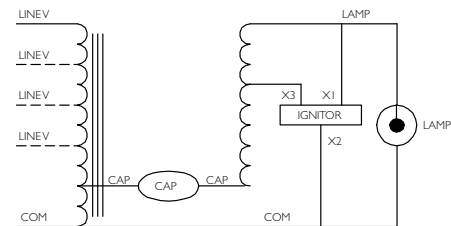
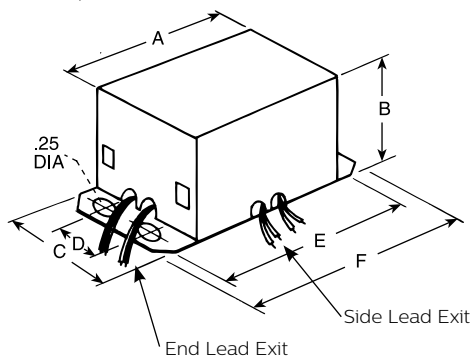

Fig. M

DIMENSIONS

Case Style	Lead Exit	A	B	C	D	E	F
PC709-2	Side	4.6	3.4	3.6	2.0	5.25	6.0
PC709-4	Side	4.6	4.4	3.6	2.0	5.25	6.0
PC767-1	Side	5.4	5.0	3.8	2.0	6.0	6.75
PC767-3	Side	5.4	5.0	4.3	2.0	6.0	6.75
PC768-1	Side	6.5	5.0	5.2	2.0	7.0	7.75
PC768-2	Side	6.5	5.0	5.9	2.0	7.0	7.75



60 Hz Postline Ballasts

Metal Halide

Input Volts	Catalog Number † (P=Thermally Protected)	Circuit Type	Input Watts	Max Input Current	Nom. Open Circuit Voltage	Fuse (amps)	Length (in)	Weight (lbs)	Spring Clip & Support Chain Kit	Max Dist To Lamp (ft)	Certifications		
											UL	SP	RoHS COMPLIANT
50W Lamp, ANSI Code M110													
120	74P5104-011P	HX-PFC	69	1.1	260	3	12.0	6.0	PL-2 (Optional)	20	✓	✓	✓

- † Ordering information:
 Order catalog number indicated. If spring clip and support chain kit is desired, order separately.
 • For HX and R circuits, figure is highest of starting, operating or open circuit current.

PL-1 and PL-2 - Spring Clip and Support Chain Kits

Included pre-assembled with all postline ballasts rated 100W and above. Support chain lowers ballast 18" down post while 6" or 10" spring clip forces ballast against post's inner wall to assure proper heat dissipation away from ballast's internal components. Also includes factory-connected ground wire to provide for proper grounding of ballast case and fixture housing. Kits include instruction sheet and may be ordered separately to retrofit existing installations.

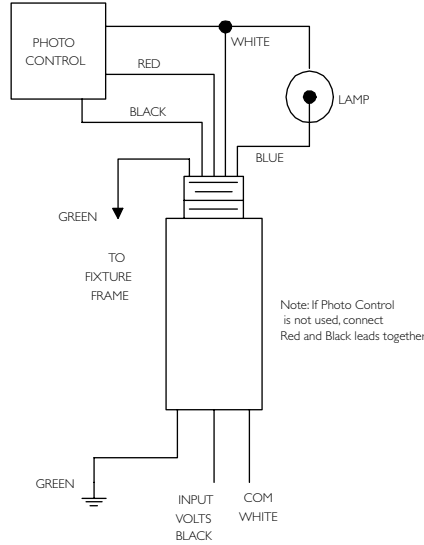
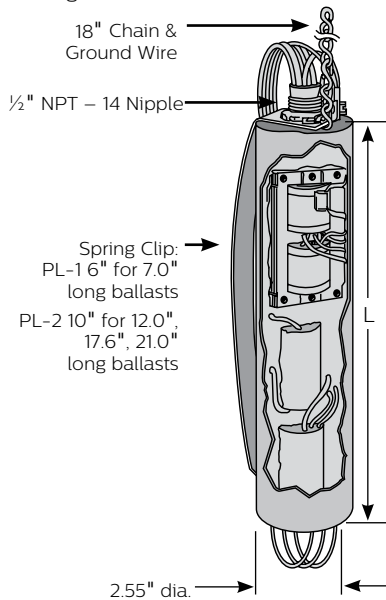

Postline Wiring Diagram

60 Hz Postline Ballasts

High Pressure Sodium



Input Volts	Catalog Number [†] (P=Thermally Protected)	Circuit Type	Input Watts	Max Input Current	Nom. Open Circuit Voltage	Fuse (amps)	Length (in)	Weight (lbs)	Spring Clip & Support Chain Kit	Max Dist To Lamp (ft)	Certifications		
											UL	SF	RoHS COMPLIANT
35W Lamp, ANSI Code S76													
120	74P7703-011P	R-HPF	43	.8	120	2	7.0	3.5	PL-1 (Optional)	10	✓	✓	✓
50W Lamp, ANSI Code S68													
120	74P7803-011P	R-HPF	61	1.3	120	4	12.0	4.8	PL-2 (Optional)	10	✓	✓	✓
70W Lamp, ANSI Code S62													
120	74P7903-011P	R-PFC	84	1.6	120	4	12.0	5.0	PL-2 (Optional)	10	✓	✓	✓
100W Lamp, ANSI Code S54													
120	74P8003-011P	R-HPF	122	2.5	120	7	17.6	7.3	PL-2 (Included)	5	✓	✓	✓
208	74P8013-011P	HX-HPF	136	1.1	208	3	21.0	12.7	PL-2 (Included)	5	✓		✓
240	74P8023-011P			1.0	240	3					✓		✓
277	74P8033-011P			.9	277	3					✓		✓
150W Lamp, ANSI Code S55 (55V Arc Tube)													
120	74P8104-011P	R-HPF	178	3.6	120	9	17.6	7.8	PL-2 (Included)	5	✓	✓	✓

[†] Ordering information:
Order catalog number indicated. Ballasts rated 100W and above include pre-assembled spring clip and support chain kit. For ballasts rated less than 100W, if spring clip and support chain kit is desired, order separately.

* 70W High Pressure Sodium ballasts with 208, 240 or 277V inputs will always be supplied with the spring clip and chain kit.

PL-1 and PL-2 - Spring Clip and Support Chain Kits

Included pre-assembled with all postline ballasts rated 100 W and above. Support chain lowers ballast 18" down post while 6" or 10" spring clip forces ballast against post's inner wall to allow for proper heat dissipation away from ballast's internal components. Also includes factory-connected ground wire to provide for proper grounding of ballast case and fixture housing. Kits include instruction sheet and may be ordered separately to retrofit existing installations.

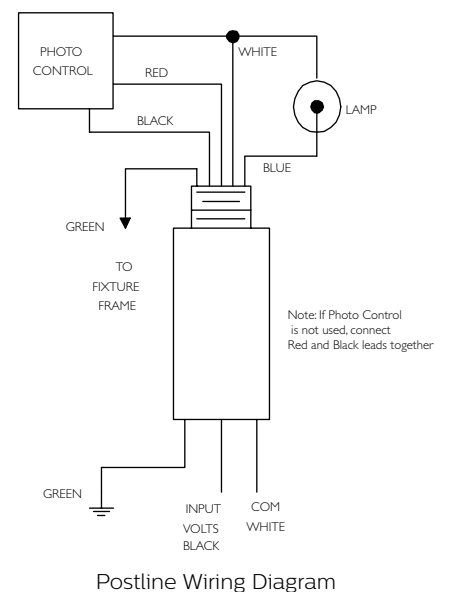
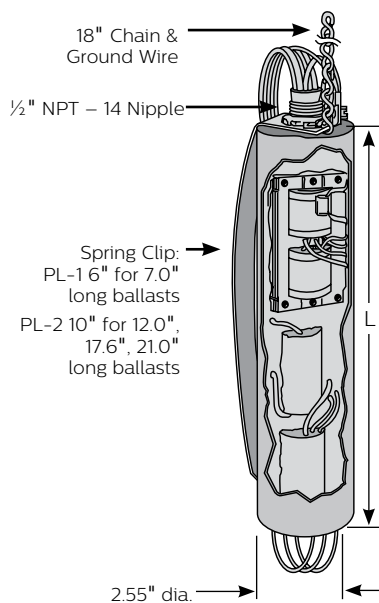

60 Hz Indoor Enclosed Ballasts

High Pressure Sodium

Input Volts	Catalog Number	Circuit Type (Maximum Ambient Temp.)	Input Watts	Max * Input Current	Nom. Open Circuit Voltage	Fuse (amps)	Wiring Dia.	Case Style	Weight (lbs)	Certification		
										UL	SF	RoHS COMPLIANT
400W Lamp, ANSI Code S51												
120/208/240/277	78E8493-001	CWA (40°C)	464	3.8/2.2/1.9/1.7	190	10/8/5/5	IE-2	PC-724	38	✓	✓	✓
480	78E8443-001			1.0		3	IE-1			✓		✓

Note: Ballasts must be mounted at least 12" apart. All indoor enclosed high pressure sodium and pulse-start metal halide lamp ballasts are furnished with a Philips Advance long-range ignitor built into the ballast enclosure. Maximum lamp-to-ballast distance is 50 ft. (except 1000W ballasts, which are 75 ft.). For ballasts not requiring ignitors, see page 7-39 for remote mounting considerations.

- For CWA circuits, figure is operating current.
- ★ Equipped with an auto-reset thermal protector to prevent ignitor from overheating in the event of lamp failure.
- ◇ White can typically used for indoor tennis courts.
- ** The 145 Watt Lamp, ANSI Code C192, is an energy saving, screw in replacement lamp for the M57 or M152 lamps that may reduce input watts up to 15% on existing 175W ballasts.
- *** The 205 Watt Lamp, ANSI Code C184 is an energy saving, screw in replacement lamp for the M58 or M138 and M153 PS lamps that may reduce input watts up to 18% on existing ballasts.
- **** The 330 Watt Lamp, ANSI Code C185 is an energy saving, screw in replacement lamp for the M59 or M135 and M155 PS lamps that may reduce input watts up to 18% on existing ballasts.
- ***** The 860 Watt Lamp, ANSI Code C194, is an energy saving, screw in replacement lamp for the 1000W M47 or M141 PS lamps that may reduce input watts up to 15% on existing ballasts.

DIMENSIONS

Case Style	A	B	C	D	E	F	G
PC-723	11 ³ / ₈	12	12 ³ / ₄	13 ³ / ₄	3 ⁵ / ₁₆	6 ⁹ / ₁₆	4 ³ / ₄
PC-724	12 ¹ / ₁₆	12 ¹¹ / ₁₆	13 ⁷ / ₁₆	14 ⁷ / ₁₆	3 ⁵ / ₁₆	7 ¹¹ / ₁₆	5 ³ / ₄
PC-746	17 ³ / ₈	18	18 ³ / ₄	19 ³ / ₄	3 ⁵ / ₁₆	7 ¹¹ / ₁₆	5 ³ / ₄

78E
INDOOR ENCLOSED
DIMENSIONS

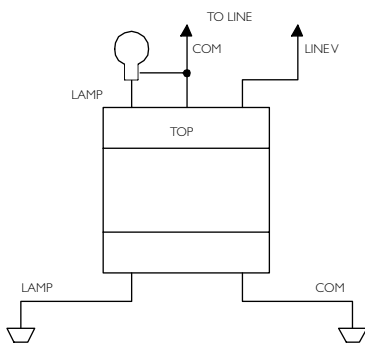
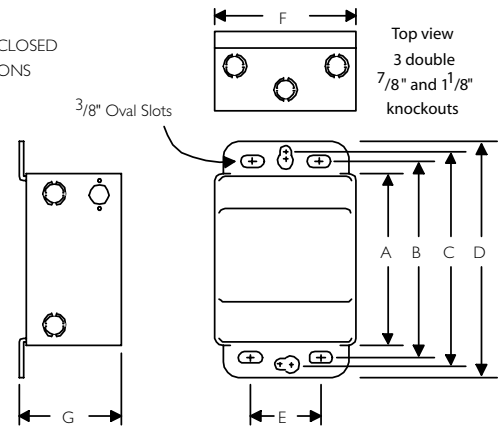

Fig IE-1

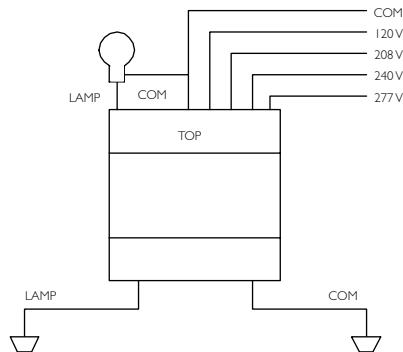

Fig IE-2

60 Hz Indoor Enclosed Ballasts

Metal Halide

Input Volts	Catalog Number	Circuit Type (Maximum Ambient Temperature)	Input Watts	Max. Input Current	Nom Open Circuit Voltage	Fuse (amps)	Wiring Dia.	Case Style	Weight (lbs)	Certification			
										UL	SF	RoHS COMPLIANT	
400W Lamp, ANSI Code M59 or 330W Lamp, ANSI Code C185****													
120/208/ 240/277	78E6091-001	CWA (55°C)	458	4.0/2.3/ 2.0/1.8	300	10/7/ 5/5	IE-2	PC-724	32	✓	✓	✓	
400W Lamp, ANSI Code M135 or 330W Lamp, ANSI Code C185**** (Pulse Start)													
120/208/ 240/277/ 480	78E6052-001EE	Super CWA (55°C)	454	3.8/2.3/ 1.9/1.7/ 1	265	10/7/ 5/5 3	IE-2	PC-724	32.8	✓	✓	✓	
1000W Lamp, ANSI Code M47, or 860W Lamp, ANSI Code C194 (Philips AllStart)*****													
120/208/ 240/277	78E6592-WC1◇ 78E6592-001	CWA (55°C)	1080	9.0/5.2/ 4.5/3.9	430	20/15/ 10/10	IE-2	PC-724	42	✓	✓	✓	
480	78E6542-001			2.3		6				IE-1	✓	✓	✓

Note: Ballasts must be mounted at least 12" apart. All indoor enclosed high pressure sodium and pulse-start metal halide lamp ballasts are furnished with a Philips Advance long-range ignitor built into the ballast enclosure. Maximum lamp-to-ballast distance is 50 ft. (except 1000W ballasts, which are 75 ft.). For ballasts not requiring ignitors, see page 7-39 for remote mounting considerations.

- For CWA circuits, figure is operating current.
- ★ Equipped with an auto-reset thermal protector to prevent ignitor from overheating in the event of lamp failure.
- ◇ White can typically used for indoor tennis courts.
- ** The 145 Watt Lamp, ANSI Code C192, is an energy saving, screw in replacement lamp for the M57 or M152 lamps that may reduce input watts up to 15% on existing 175W ballasts.
- *** The 205 Watt Lamp, ANSI Code C184 is an energy saving, screw in replacement lamp for the M58 or M138 and M153 PS lamps that may reduce input watts up to 18% on existing ballasts.
- **** The 330 Watt Lamp, ANSI Code C185 is an energy saving, screw in replacement lamp for the M59 or M135 and M155 PS lamps that may reduce input watts up to 18% on existing ballasts.
- ***** The 860 Watt Lamp, ANSI Code C194, is an energy saving, screw in replacement lamp for the 1000W M47 or M141 PS lamps that may reduce input watts up to 15% on existing ballasts.

DIMENSIONS

Case Style	A	B	C	D	E	F	G
PC-723	11 ³ / ₈	12	12 ³ / ₄	13 ³ / ₄	3 ⁵ / ₁₆	6 ⁹ / ₁₆	4 ³ / ₄
PC-724	12 ¹ / ₁₆	12 ¹¹ / ₁₆	13 ⁷ / ₁₆	14 ⁷ / ₁₆	3 ⁵ / ₁₆	7 ¹¹ / ₁₆	5 ³ / ₄
PC-746	17 ³ / ₈	18	18 ³ / ₄	19 ³ / ₄	3 ⁵ / ₁₆	7 ¹¹ / ₁₆	5 ³ / ₄

78E
INDOOR ENCLOSED
DIMENSIONS

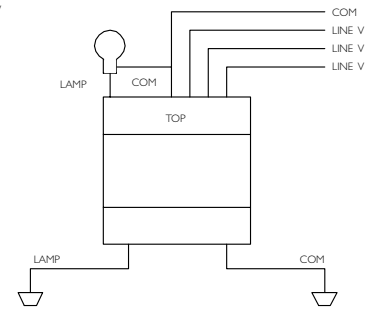
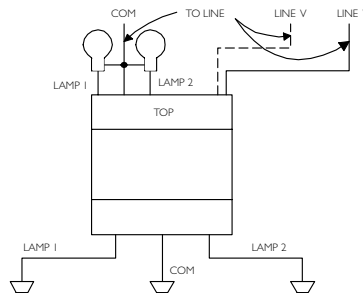
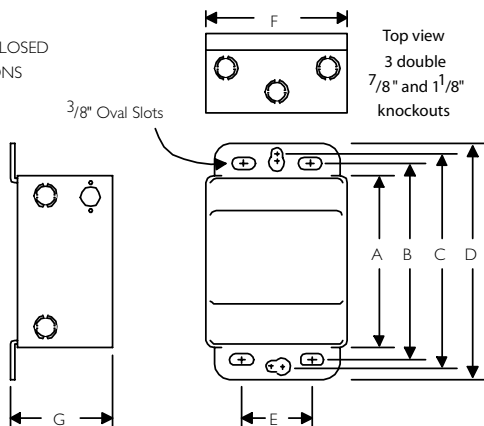

60 Hz Outdoor Weatherproof Ballasts

Metal Halide

Input Volts	Catalog Number	Circuit Type	Input Watts	Max Input Current	Nom Open Circuit Voltage	Fuse (amps)	Wiring Dia.	Height (in)	Weight (lbs)	Certification		
										UL	SF	RoHS COMPLIANT
175/150W Lamp, ANSI Code M57/M107 or 145W Lamp, ANSI Code C192**												
120/208/240/277	79W5590-001	CWA	210	1.8/1.1/.9/8	305	5/3/3/2	OW-2	6.6	15	✓	✓	✓
250W Lamp, ANSI Code M58 or 205W Lamp, ANSI Code C184***												
120/208/240/277	79W5790-001	CWA	285	2.5/1.5/1.3/1.1	310	8/5/5/3	OW-2	8.6	18	✓	✓	✓
400W Lamp, ANSI Code M59 or 330W Lamp, ANSI Code C185****												
120/208/240/277	79W6091-001	CWA	458	4.0/2.3/2.0/1.8	300	10/7/5/5	OW-2	8.6	21	✓	✓	✓
480	79W6041-001		462	1.0		4	OW-1					
Two 400W Lamps, ANSI Code M59 or two 330W Lamp, ANSI Code C185****												
120/240	79W6351-001	CWA (ILO)	890	8.4/4.2	330	25/15	OW-3	13.8	43	✓	✓	✓
480	79W6341-001			2.1		7						
1000W Lamp, ANSI Code M47												
120/208/240/277	79W6592-001	CWA	1080	9.0/5.2/4.5/3.9	430	20/15/10/10	OW-2	11.3	33	✓	✓	✓
480	79W6542-001			2.3		6	OW-1					

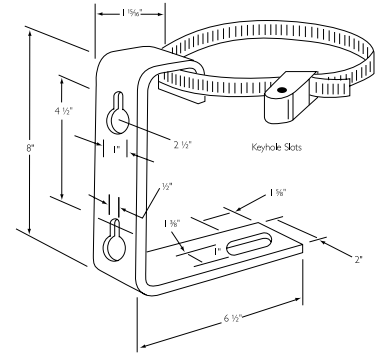

SH-1 Mounting Bracket Kit (includes bracket & band clamp, order separately)

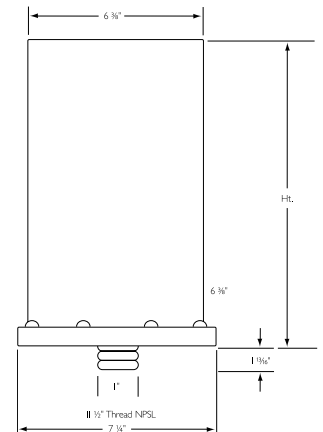

All weatherproof high pressure sodium lamp ballasts are furnished with a Philips Advance long-range ignitor built into the ballast enclosure. Maximum lamp-to-ballast distance is 50 ft. (except 1000W ballasts which are 75 ft.).

- For CWA circuits, figure is operating current. For HX circuits, figure is highest of starting, operating or open circuit current.
- ★ Equipped with an auto-reset thermal protector to prevent ignitor from overheating in the event of lamp failure.
- ** The 145 Watt Lamp, ANSI Code C192, is an energy saving, screw in replacement lamp for the M57 or M152 lamps that may reduce input watts up to 15% on existing 175W ballasts.
- *** The 205 Watt Lamp, ANSI Code C184 is an energy saving, screw in replacement lamp for the M58 or M138 and M153 PS lamps that may reduce input watts up to 18% on existing ballasts.
- **** The 330 Watt Lamp, ANSI Code C185 is an energy saving, screw in replacement lamp for the M59 or M135 and M155 PS lamps that may reduce input watts up to 18% on existing ballasts.

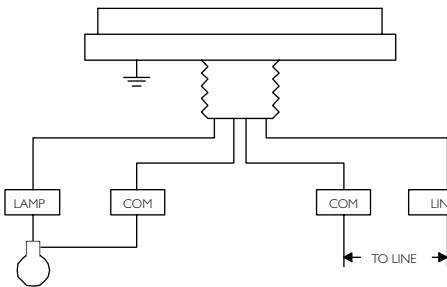

Fig OW-1

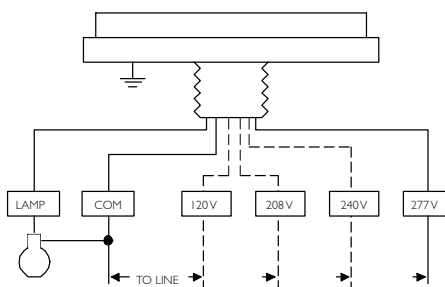

Fig OW-2

INSULATE UNUSED ALTERNATE LAMP LEADS INDIVIDUALLY FOR 600V

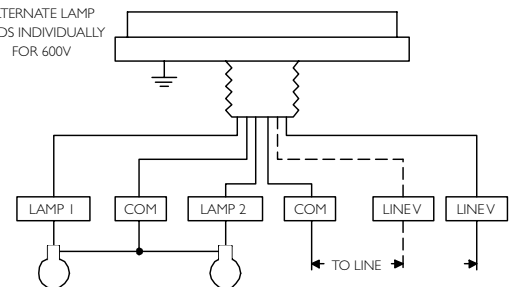

Fig OW-3

60 Hz Outdoor Weatherproof Ballasts

High Pressure Sodium

Input Volts	Catalog Number	Circuit Type	Watts Input	Max Input Current	Nom Open Circuit Voltage	Fuse (amps)	Wiring Dia.	Height (in)	Weight (lbs)	Certification		
										UL	SF	RoHS COMPLIANT
400W Lamp, ANSI Code S51												
120/208/240/277	79W8493-001	CWA	464	3.8/2.2 1.9/1.7	430	10/8/ 5/5	OW-2	11.3	20	✓	✓	✓
480	79W8443-001			1.0		3	OW-1			✓		✓
1000W Lamp, ANSI Code S52												
120/208/240//277	79W8793-001	CWA*	1100	9.5/5.5/ 4.8/4.2	435	25/15/ 10/10	OW-2	13.8	34	✓	✓	✓
480	79W8743-001			2.3		6	OW-1			✓		✓

All weatherproof high pressure sodium lamp ballasts are furnished with a Philips Advance long-range ignitor built into the ballast enclosure. Maximum lamp-to-ballast distance is 50 ft. (except 1000W ballasts which are 75 ft.).

• For CWA circuits, figure is operating current. For HX circuits, figure is highest of starting, operating or open circuit current.

★ Equipped with an auto-reset thermal protector to prevent ignitor from overheating in the event of lamp failure.

** The 145 Watt Lamp, ANSI Code C192, is an energy saving, screw in replacement lamp for the M57 or M152 lamps that may reduce input watts up to 15% on existing 175W ballasts.

*** The 205 Watt Lamp, ANSI Code C184 is an energy saving, screw in replacement lamp for the M58 or M138 and M153 PS lamps that may reduce input watts up to 18% on existing ballasts.

**** The 330 Watt Lamp, ANSI Code C185 is an energy saving, screw in replacement lamp for the M59 or M135 and M155 PS lamps that may reduce input watts up to 18% on existing ballasts.

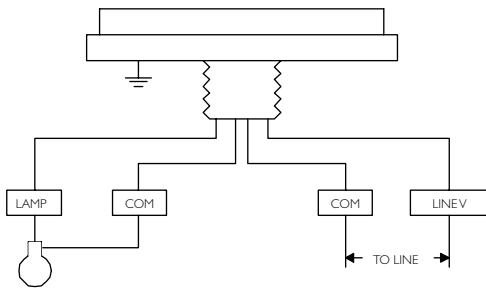

Fig OW-1

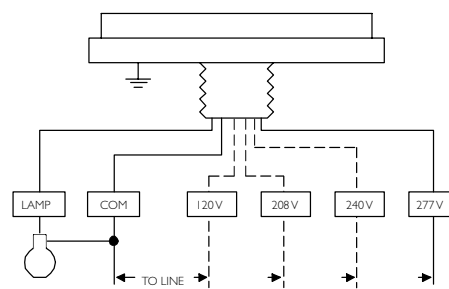
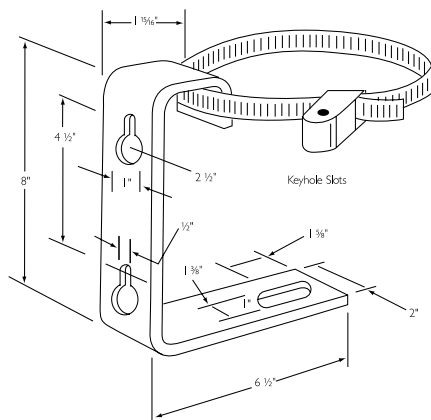
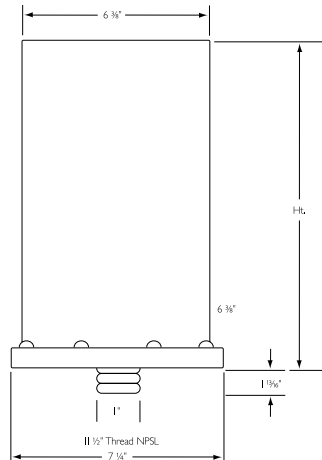

Fig OW-2



SH-1 Mounting Bracket Kit
(includes bracket & band clamp,
order separately)



International Electromagnetic Hid Ballasts

We offer an extensive range of High Intensity Discharge ballasts to run ANSI specification (U.S. style) lamps. These ballasts are suitable for international markets and range in voltage from 120 through 240V, 50 Hz.

Philips Advance HID ballasts are available to operate the wide variety of mercury, metal halide, high pressure sodium and low pressure sodium lamps available in today's marketplace.

Like fluorescent, HID lamps are electric discharge lamps. Light is produced by an arc discharge between two electrodes located at opposite ends of an arc tube within the lamp's outer glass envelope. The ballast is the lamp's power supply; its purpose is to provide proper starting and operating voltage and current to initiate and sustain this arc.

Core & Coil

The basic ballast is the open core & coil, which is most often used as a component within a lighting fixture. The core & coil also forms the nucleus of the five other ballast configurations detailed in this section. It consists of either one, two or three copper coils on a core (or "stack") of electrical-grade steel laminations. The coils are assembled to core section, which are then surface-welded together. The assembled Philips Advance ballast is vacuum impregnated with a silica-filled polyester varnish to re-enforce the electrical insulation, preclude moisture, inhibit noise and dissipate heat. Some HID ballast manufacturers apply varnish via a preheat-and-dip process, which only puts a thin coat of varnish on the outer surface of the ballast.

Encapsulated Core & Coil

Where quiet performance is required, the standard open core & coil ballasts are encapsulated (potted) in a cube-shaped steel can utilizing Class H (180°C) polyester compound. These ballasts carry a Class A noise rating up through 175W and Class B for 250 and 400W. As with the open core & coil, the capacitor (and ignitor where included) are mounted separately within the fixture.

EPAAct 2005

The Energy Policy Act of 2005 (EPAAct 2005) requires that mercury vapor lamp ballasts shall not be manufactured in or imported into the United States after January 1, 2008. With regard to imported ballasts, the standard applies to both the importing of ballasts as well as the importing of mercury vapor lamp luminaires with ballasts, since importing a mercury vapor lamp luminaire with a mercury vapor lamp ballast would be the same as importing a mercury vapor lamp ballast. Therefore, as of January 1, 2008, luminaires cannot be imported with mercury vapor lamp ballasts.

Replacements

For capacitors, see pages 7-37 and 7-38.

For ignitors, see pages 7-39 to 7-43.

Special Voltages

For voltage and frequencies not shown in the charts of the following pages, please contact your Philips sales representative.

CERTIFICATIONS



Indicates ballast is listed by Underwriters Laboratories, Inc. in accordance with UL 1029 Standard for HID Ballasts. Each ballast is marked appropriately.



All HID Ballasts are designed and manufactured in accordance with the American National Standards Institute Standard for HID Ballasts, ANSI C82.4.



Norma Obligatoria Mexicana.
(Contact your local salesperson for availability.)



Restrictions on Hazardous Substances (RoHS) is a European directive (2002/95/EC) designed to limit the content of 6 substances [lead, mercury, cadmium, hexavalent chromium, polybrominated biphenyls (PBB), and polybrominated diphenyl ethers (PBDE)] in electrical and electronic products.

50 HZ Core & Coil Ballasts

Mercury

Ballasts for operating Mercury lamps are for use outside the USA ONLY

Input Volts	Catalog † Number	Circuit Type	Watts Input	Max Input Current	Nom Open Circuit Voltage	Fuse Rating (Amps)	Wiring Dia	Dimensions			Non-PCB Capacitor (Page 7-37 & 7-38)				Total Weight (lbs)	U.L. Bench Top Rise Code 1029 (Pg 7-3)
								Fig	A	B	Mfd	Min Volt	Cap Catalog Number	Dry or Oil		
175W Lamp, ANSI Code H39																
120/ 220/240	See 175W Metal Halide CWA 71A55N0-500 (page 7-59)															
250W Lamp, ANSI Code H37																
120/ 220/240	See 250W Metal Halide CWA 71A57N0-500D (page 7-59)															
400W Lamp, ANSI Code H33																
120/ 220/240	See 400W Metal Halide CWA 71A60N1-500 (page 7-59)															
1000W Lamp, ANSI Code H36																
120/ 220/240	See 1000W Metal Halide CWA 71A65N2-500 (page 7-59)															

† Ordering information:

Original equipment ballasts - add proper suffix to catalog number:

- 500D includes core & coil with dry-film capacitor
- 510D includes core & coil with welded bracket and dry-film capacitor
- 600 core & coil only (no capacitor)

• For CWA circuits, figure is operating current.

WELDED BRACKET DIMENSIONS

Ballast Dimensions Fig	L	W	M	S
1	5.1	1.00	4.50	0.25
2	6.5	1.25	5.75	0.28

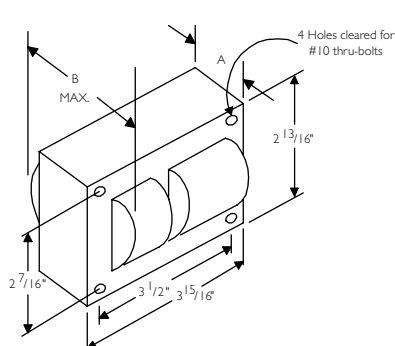

Fig. 1
(3" x 4" Core)

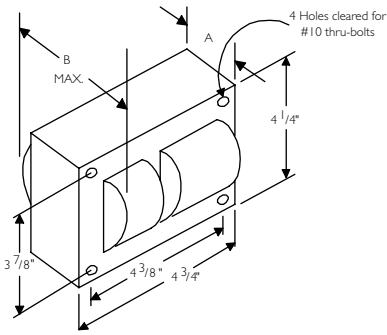

Fig. 2
(4 1/4" x 4 3/4" Core)

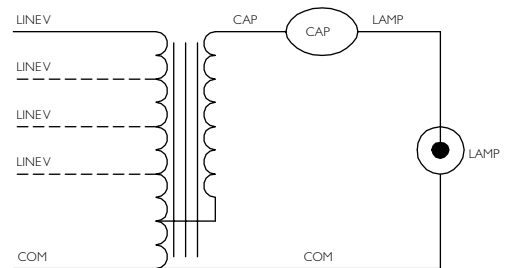
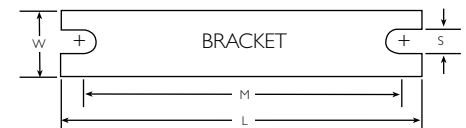

Fig. A

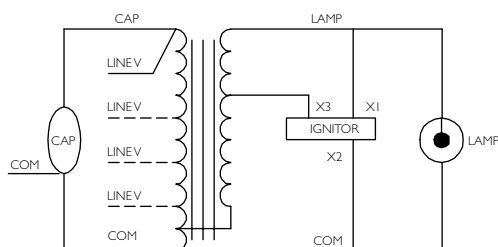

Fig. K

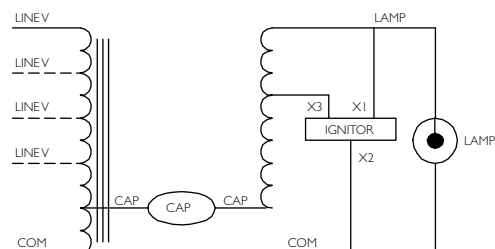

Fig. M







50 HZ Core & Coil Ballasts

Metal Halide

Input Volts	Catalog [†] Number	Circuit Type	Watts Input	Max Input Current	Nom Open Circuit Voltage	Fuse Rating (Amps)	Wiring Dia	Dimensions			Non-PCB Capacitor (Page 7-37 & 7-38)				Total Weight (lbs)	Ignitor †† (Page 7-39 to 7-43)		U.L. Bench Top Rise Code 1029 (Pg 7-3)				
								Fig	A	B	Mfd	Min Volt	Cap Catalog Number	Dry or Oil		Part Number	Max Dist To Lamp (ft)	Class H (180°C)	Philips Advance Class N (200°C)			
70W Lamp, ANSI Code M98 or M143 (Pulse Start)																			RoHS COMPLIANT			
120/220-240	71A52N2-500D	HX-HPF	95	1.7/1.0/.9	256	5/3/3	K	1	1.5	2.8	14	280	7C140M30RA	D	5.0	LI533-H4	15	B/A/B	-			
100W Lamp, ANSI Code M90 or M140 (Pulse Start)																			RoHS COMPLIANT			
120/220-240	71A53N0-500D	HX-HPF	129	2.2/1.2/1.1	266	6/3/3	K	1	1.9	3.2	17.5	300	7C175M30RA	D	6.0	LI533-H4	15	A/A/A	-			
150W Lamp, ANSI Code M102 or M142 (Pulse Start)																			RoHS COMPLIANT			
120/220-240	71A54N2-500D	HX-HPF	187	3.7/2.0/1.8	248	10/5/5	K	1	2.5	4.1	28	240	7C280P30RA	D	7.5	LI533-H4	5	C/C/D	-			
175W Lamp, ANSI Code M57 or H39; or 150 Watt Lamp, ANSI Code M107																			RoHS COMPLIANT			
120/220-240	71A55N0-500	CWA	210	2.0/1.0	310	5/3	A	1	2.8	4.0	12	450	MD1204-100	O	9.0	-	-	C/C	-			
250W Lamp, ANSI Code M58 or H37																			RoHS COMPLIANT			
120/220-240	71A57N0-500D	CWA	290	2.5/1.3	315	7/4	A	2	1.9	3.4	18	400	7C180P40-R	D	11.5	-	-	D/A	-			
250W Lamp, ANSI Code M138 or M153 (Pulse Start)																			RoHS COMPLIANT			
120/220-240	71A57N2-500D	Super CWA	294	2.6/1.4	280	6/3	M	2	1.8	3.3	20	330	7C200P33-R	D	11.5	LI533-H4	5	C/C	-			
320W Lamp, ANSI Code M132 or M154 (Pulse Start)																			RoHS COMPLIANT			
120/220-240	71A58N2-500D	Super CWA	365	3.1/1.6	280	10/5	M	2	2.1	3.8	24	400	7C240P40-R	D	12.5	LI533-H4	2	A/A	-			
400W Lamp, ANSI Code M59 or H33																			RoHS COMPLIANT			
120/220-240	71A60N1-500	CWA	462	4.1/2.1	320	10/6	A	2	2.2	3.7	24	450	MD2409-100	O	14.0	-	-	D/D	-			
400W Lamp, ANSI Code M135 or M155 (Pulse Start)																			RoHS COMPLIANT			
120/220-240	71A60N2-500D	Super CWA	454	3.9/2.0	270	10/5	M	2	2.1	3.8	30	345	7C300P34	D	12.3	LI533-H4	2	C/E	-			
1000W Lamp, ANSI Code M47 or H36																			RoHS COMPLIANT			
120/220-240	71A65N2-500	CWA	1090	9.3/5.0/4.5	450	24/13/13	A	8	3.0	5.0	26	525	MD2602-100	O	23.0	-	-	D/C/C	A/A/A			

50 HZ Core & Coil Ballasts

High Pressure Sodium

Input Volts	Catalog† Number	Circuit Type	Watts Input	Max Input Current	Nom Open Circuit Voltage	Fuse Rating (Amps)	Wiring Dia	Dimensions			Non-PCB Capacitor (Page 7-37 & 7-38)				Total Weight (lbs)	Ignitor †† (Page 7-39 to 7-43)		U.L. Bench Top Rise Code 1029 (Pg 7-3)				
											Mfd	Min Volt	Cap Catalog Number	Dry or Oil		Part Number	Max Dist To Lamp (ft)	Class H (180°C)	Philips Advance Class N (200°C)			
								Fig	A	B												
70W Lamp, ANSI Code S62																			RoHS COMPLIANT			
120/220/240	71A79N1-500D	HX-HPF	94	1.4/0.8/1.7	125	4/2/2	K	1	1.9	3.1	8.4	280	7C084L30RA	D	6.0	LI551-H4	2	A/A	-			
100W Lamp, ANSI Code S54																			RoHS COMPLIANT			
120/220/240	71A80N1-500D	HX-HPF	130	2.4/1.3/1.2	120	6/4/4	K	1	2.4	3.7	12	280	7C120M30RA	D	8.0	LI551-H4	2	A/A	-			
150W Lamp, ANSI Code S55																			RoHS COMPLIANT			
120/220/240	71A81N2-500D	HX-HPF	188	2.9/1.5/1.4	120	8/5/4	K	14	3.0	4.5	17.5	260	7C175M30RA	D	9.4	LI551-H4	2	C/B/B	-			
250W Lamp, ANSI Code S50																			RoHS COMPLIANT			
120/220-240	71A82N1-500D	CWA	300	2.8/1.4	190	7/4	M	2	2.1	3.7	40	240	7C400P30-RA	D	12.0	LI501-H4	2	D/C	-			
400W Lamp, ANSI Code S51																			RoHS COMPLIANT			
120/220-240	71A84N3-500D	CWA	465	4.0/2.0	190	10/6	M	2	2.5	4.1	64	280	7C640S28-RA	D	15.0	LI501-H4	2	D/D	-			
1000W Lamp, ANSI Code S52																			RoHS COMPLIANT			
220/240	71A87R3-500	CWA	1100	6.0/5.6	435	15/15	M	8a	4.3	6.3	28	580	2 Capacitor Set: MD1408-230 (2) 14mFd Caps Connected in Parallel	O	35.5	LI571-H5★	2	E/E	A/A			

† Ordering information:

Original equipment ballasts - add proper suffix to catalog number:

- 500D includes core & coil with dry-film capacitor
- 510D includes core & coil with welded bracket and dry-film capacitor
- 500 includes core & coil with oil-filled capacitor
- 510 includes core & coil with welded bracket and oil-filled capacitor
- 600 core & coil only (no capacitor)

†† Each ballast requiring an ignitor is furnished as standard with the short-range ignitor model shown for use within fixtures. If a long-range ignitor is required for remote mounting, specify on order. See pages 7-39 to 7-43 for additional information.

- For HX and R circuits, figure is highest of starting, operating or open circuit current.
- For CWA circuits, figure is operating current.

- ★ Equipped with an auto-reset thermal protector to prevent ignitor from overheating in the event of lamp failure.

WELDED BRACKET DIMENSIONS

Ballast Dimensions Fig	L	W	M	S
1	5.1	1.00	4.50	0.25
2	6.5	1.25	5.75	0.28
8	7.8	2.75	6.13	0.25
8a	7.8	4.50	6.75	0.31

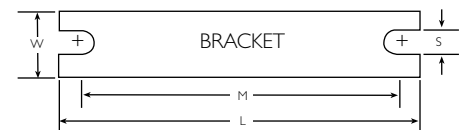

Dimension and Wiring Diagrams

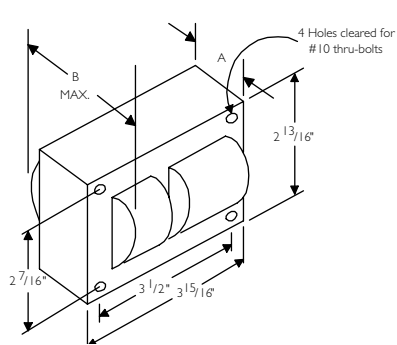

Fig. 1
 (3" x 4" Core)

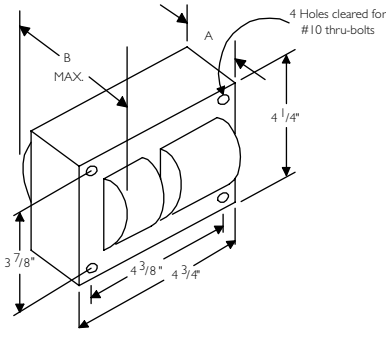

Fig. 2
 (4 1/4" x 4 3/4" Core)

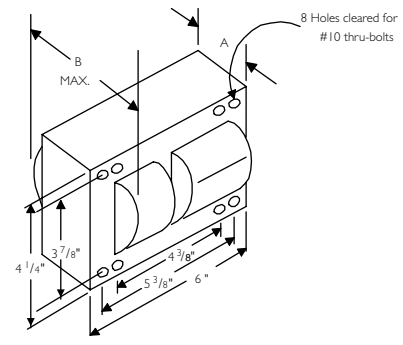

Fig. 8 and 8a
 (4 1/4" x 6" core)

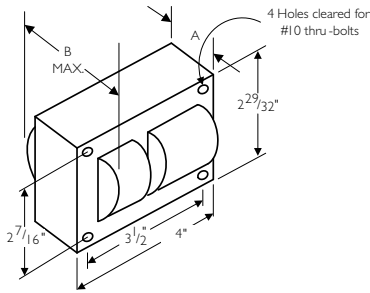

Fig. 14
 (3" x 4" Core)

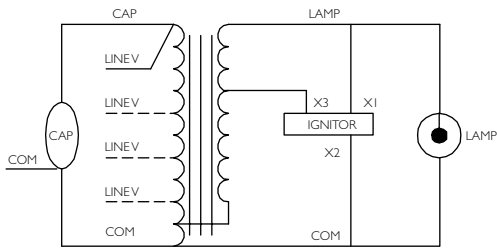

Fig. K

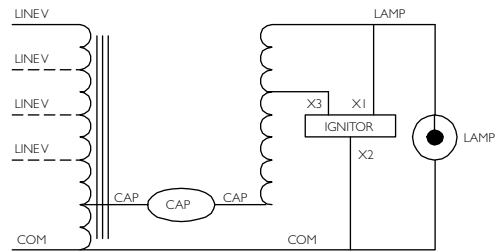

Fig. M

Controls



Indoor Daylight and Occupancy Sensors	8-1
LuxSense Daylight Regulation Sensor	8-1
MicroLuxSense Daylight Regulation Sensor	8-2
ActiLume 0-10V Lighting Control System	8-3
Outdoor Luminaire Based Controls	8-4
Dynadimmer 0-10V Lighting Control System	8-4
Outdoor Telemangement Systems	8-6
Starsense	8-6

Corporate Offices
(800) 322-2086

Customer Support/Technical Service
(800) 372-3331 • (+) 1 847 390-5000 (International)

Visit our web site at www.philips.com/oemna.

LuxSense Daylight Regulation Sensor

Provides daylight regulation via a single miniature sensor

The LuxSense daylight sensor can control up to 20 fixtures equipped with Philips Advance Mark 7 0-10V fluorescent ballasts or compatible e-Vision HID ballasts, as well as Xitanium drivers. The sensor measures reflected light coming from the designated surface below, such as a desk or tabletop. It dims lamp output when the light level exceeds the required level defined by the LuxSense sensor. The light level easily adjusts via a simple dial.

Luxsense provides the benefit of a comfortable and controllable level of illumination throughout the working day. More importantly it can provide energy savings when installed near windows where natural illumination is usually greatest.

It is also designed to save additional energy by reducing excess light output occurring from design factors of lumen depreciation. Lamps are dimmed slightly when new, but then raised over time to compensate for depreciation of lamp output that occurs in normal lamp aging.

Up to a potential 32% energy savings without sacrificing visual comfort*
State-of-the-art daylight sensor

No specific lighting control training needed
Simple to use lighting control system; just adjust the rotating diaphragm to set the desired light level

Flexibility in design
Can be incorporated directly into a fixture or alternatively clipped to a T8 or T5 lamp**

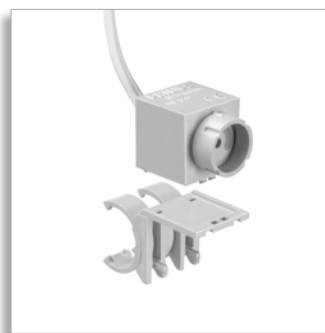

For more information,
visit <http://www.philips.com/lightingcontrolsna>.

* Galasiu, A.D. "Energy saving lighting control systems for open-plan offices: field study," National Research Council Canada, v4 no1, July 2007 pg. 15 -16.

** External installation low voltage wiring where allowed by local codes.

MicroLuxSense Daylight Regulation Sensor

Provides daylight regulation via a single miniature sensor

MicroLuxSense is a simple and easy to design-in daylight compensation option for luminaires equipped with a Philips 0-10V dimming ballast/driver for a variety of technologies including LED. The sensor measures reflected light coming from the surface below. It dims lamp output when the light level exceeds the required light level defined by the light sensor set point providing the end-user energy savings at ease.

MicroLuxSense arrives from the factory ready to install. It comes in a standard preset configuration so no complex commissioning is required. Its versatile design allows this device to be installed adjacent to the luminaire with the ceiling mounting plate option or in the luminaire either mounted between the louvers or recessed in the housing. MicroLuxSense contains a simple-to-use dial for adjusting light levels in the field. It also shares the same footprint as the ActiLume family of sensors making one luminaire design capable of housing a variety of control options from Philips.

MicroLuxSense is ideal for private offices, meeting and conference rooms, classrooms, break areas and smaller open office area, anywhere with ample amounts of ambient light are present with the potential for providing energy savings without sacrificing visual comfort*.

Up to a potential 32% energy savings without sacrificing visual comfort*
Advanced daylight harvesting sensor

Enables compliance with energy codes and may qualify for additional LEED points
Sustainable solution

Automated regulation of artificial lighting allows for task illumination to be maintained
Maximize visual comfort

One sensor can be used for continuous rows or multiple sensors with single luminaires
Regulate up to 20 luminaires

* Galasiu, A.D. "Energy saving lighting control systems for open-plan offices: field study," National Research Council Canada, v4 no1, July 2007 pg. 15 -16.



**For more information,
visit <http://www.philips.com/lightingcontrolsna>.**

ActiLume 1-10V Lighting Control System

Lighting control made simple

The ActiLume 1-10V System is a simple-to-install and easy-to-use lighting control system designed to operate in personal or open office settings. This system contains both a light sensor for daylight harvesting and movement detector for occupancy sensing. Research shows that daylight and occupancy sensing functionality provides a potential energy savings of up to 65% without sacrificing light levels.* ActiLume 1-10V can automatically switch the lights on and off with its occupancy sensing feature. The daylight harvesting feature will dim the luminaires when enough daylight enters the room offering automatic energy savings without the need for complex commissioning.

The ActiLume 1-10V System consists of a sensor and a control unit designed to be built directly in to a luminaire. The sensor provides both daylight harvesting and occupancy detection. The system can be used with any Philips Advance 0-10V dimming or fixed output ballast/driver. The ActiLume 1-10V sensor shares a common footprint with other sensors in the ActiLume family making one luminaire design capable of housing a variety of control options from Philips.

Installers and end-users do not have to worry about complicated programming anymore. Commissioning is effortless – simply use a small screwdriver to adjust the light level and/or occupancy detection time delay. The ActiLume 1-10V System is a truly Plug-and-Play lighting control system that provides excellent visual comfort and automatic energy savings with simple installation.

Save on installation and maintenance costs.
No professional training required for commissioning and light level adjustments.

Installation ease with one-step commissioning

Maximize visual comfort

Automated regulation of artificial lighting allows for task illumination to be maintained.



For more information,
visit <http://www.philips.com/lightingcontrolsna>.

* Galasiu, A.D. "Energy saving lighting control systems for open-plan offices: a field study." National Research Council Canada, v4 no1, July 2007 pg. 15-16.

Dynadimmer 0-10V Lighting Control System

A simple, easy-to-install outdoor controller for electronic lighting systems

The Dynadimmer is a stand-alone dimming control with a 0-10V dimming output that can be used in combination with a compatible dimmable electronic driver. Easy to install into a luminaire or pole without any need for external control components or additional signal wiring, it is fully flexible and can be reprogrammed at any time to fit new lighting demands if changes are needed.

The Dynadimmer can be configured to dim to any level that the end-user wishes at set periods, with a maximum of five set periods. Both the levels and the time period are configured with an easy-to-use software tool, which also calculates and displays the energy savings that may be obtained from a particular dimming schedule.

The designed configuration is then loaded into a standard personal computer that will be used later to program the Dynadimmer via a USB cable. This configuration can be modified at any time by downloading a new dimming schedule to adapt the lighting to a new situation or simply fine-tune the savings.

The five time periods and five dim levels provide an optimal schedule whether the application is an industrial area, parking lot, residential area or road. The Dynadimmer can help to meet certain road/area-lighting requirements and standards, which entail the introduction of illumination levels that take account of road use and/or traffic flows.

Energy savings and reduced light nuisance through dimming

Small size that can fit within almost any luminaire

Easy-to-use software that can provide a forecast of energy savings

Energy savings may be maximized with the Dynadimmer. The fact that any level can be configured at any time makes very low levels late at night possible, high levels at peak times (though not necessarily 100%) and medium levels during the transitional periods. For example, a dimming schedule like the one shown in the picture projects an overall yearly energy saving of 35%.

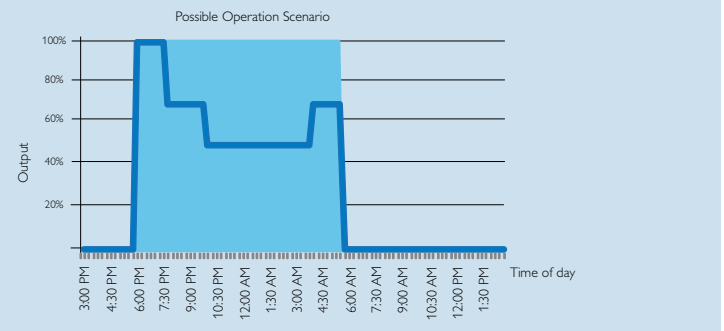

Dynadimmer Standard Programming Schedule

Ordering information

Ordering Code	Description	Compatible Ballasts
LLC7230	Dynadimmer 0-10V	0-10V eHID ballasts and LED drivers
LCC7210	USB PC Cable	
KIT7210	Programming Kit	

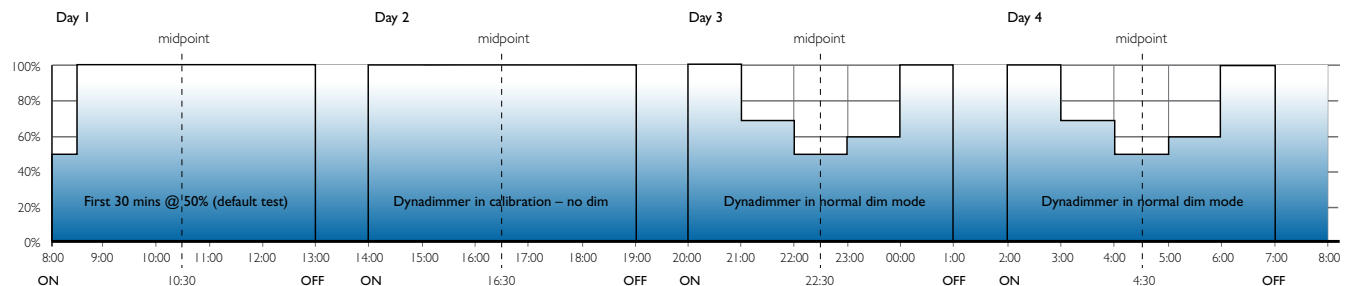

Technical data

Storage conditions

Temperature	min -40°F (-40°C) / max 176°F (80°C)
Relative humidity	min 5% / max 95% RH

Operating conditions

Ambient temperature	min -22°F (-30°C) / max 140°F (60°C)
Case temperature	80° C
Relative humidity	min 10% / max 90% RH (no condensation)

Mains connection

Operational voltage	120-277V ± 10%
Frequency	50/60 Hz ± 5%
Maximum load	Not applicable

Mains / 1-10v connections

Connector type	WAGO 250 Cage Clamp
Drivers per Dynadimmer 1-10v	2 max.
Wire range	18 gauge
Wire strip length	8 in (203 mm)
Power consumption	0.5W at 220VAC/60Hz

Programming connector

Connector type	Micro MATE-N-LOK connector
Factory setting	After power-up, the control voltage will rise slowly to +5VDC

Dim interface

Control voltage	1-10V
Max. current	0.3mA sinking
Dim curve	Defined by selected driver
Protection	Protected against accidental connection with mains voltage
Output impedance	2700 ohm

Housing

Protection class	Tested to IP66
Dimensions (H x W x L)	1 x 2.125 x 3.15 inches (25 x 54 x 80 mm)
Weight	0.085 Kg
Material	PC-GE LEXAN 223R-111
Color	Black
Glow wire test	≥ 850° C at 1 mm material thickness
Flammability	UL94-V2 at 0.75 mm material thickness UL94-V0 at 6 mm material thickness
Fixation	M8 x 16 bold (class 8.8) or 2 x M4 screw with cylinder head

The LLC7230 is designed to be built into a luminaire, a box, an enclosure or the like and is not intended to be mounted outside a luminaire, etc., without special precautions. The LLC7230 housing provides insulation for class 2.

Safety

1-10V interface	The interface is double (0-10V) isolated from the mains supply (4kV routine test for transformer)
Programming interface	The interface is double (0-10V) isolated from the mains supply (4kV routine test for transformer)



Warning

Mains has to be disconnected before connecting the programmer. Failure to do so could result in personal injury and/or damage to the Dynadimmer.

Starsense Lighting Control System

A cost-effective telemanagement outdoor lighting control system

Starsense is a telemanagement system with remote control of outdoor light points on highways, roads, streets and in residential areas. It is designed to save energy by enabling individual light points to be switched on or off at any given time or set to any dimming level. It makes outdoor lighting installations intelligent and dynamic.

Features and benefits

Starsense controls and monitors any lamp type from electromagnetic ballasts to electronic drivers making it a flexible choice.

Starsense can accurately detect failures in the light points which can lower maintenance costs.

Starsense's user-friendly software tool is easily accessible from the internet and shows relevant information such as failures, energy consumption, lifetime, etc. With real-time monitoring using web mapping services from the Internet, this system is able to provide immediate information and feedback.



Please contact your local Philips sales representative to learn more about the Philips Starsense solutions.

Technical data

Operating conditions		Data rate	250 kbit/s
Ambient temperature (t _a)	-22°F to 140°F (-30°C to 60°C)	Antenna	Internal 1/4 wave monopole
Relative humidity	10 to 90%	Transmitter output power	89dBμV/m
Max. housing temperature	176°F (80°C)	Receiver sensitivity	46dBμV/m
Lifetime	90% operational products after 80,000 hours of operation	Transceiver security	AES128 encryption
		* NOTE: Multiple OLC's should be in range of the Segment Controller.	
Non-operating conditions		Certifications/misc	
Temperature	-22°F to 176°F (-30°C to 80°C)	Conducted emission	FCC 47 Part 15
Relative humidity	5 to 90%	Radiated emission	FCC 47 Part 15
		ANSI	136.10
		Flammability	UL 94V-0
		Protection class	IP54
		Housing material	Polycarbonate (PC)
Mains connection		Damp heat	IEC 60068-2-30
Mains voltage (LFC7320)	120VAC ±10%	Salt mist	IEC 60068-2-11
Mains voltage (LFC7310)	240/480VAC ±10%	Mixed gas corrosion	IEC 60068-2-60
Mains frequency	50/60 Hz ± 5%	Vibration	IEC 60068-2-6
Max. load wattage	750VA @ 120V 1000VA @ 277V, 347V, 480V	Rain tightness test	UL773
Recommended external fuse	15A Maximum	Temperature sensor	37°F (3°C) (-22°F to 140°F / -30°C to 60°C range)
		Agency marking	UL, CSA, NOM
Power consumption			
Operating wattage	50W		
Accuracy integrated power	±5% consumption metering		
Radio frequency			
Protocol	IEEE802.15.4		
Frequency band	906-924MHz		
Range	300m (OLC to OLC) 50m (OLC to SC)		

Reference



Industry Terms	9-2
Ballast Specifications	9-6
Catalog Number to Page Number	
Fluorescent Ballast	9-24
Magnetic HID Ballast	9-29
Electronic HID Ballast	9-30
Discontinued Catalog Number to Replacement Number	
Magnetic Fluorescent	9-31
Electronic Fluorescent	9-34
Magnetic HID	9-38
Electronic HID	9-42
Lamp to Ballast Page Number	
Fluorescent Lamp	9-43
HID Lamp	9-47
Compact Fluorescent Lamp	9-48

Corporate Offices
(800) 322-2086

Customer Support/Technical Service
(800) 372-3331 • (+) 1 847 390-5000 (International)

Visit our web site at www.philips.com/oemna.

All products contained within this catalog carry a limited warranty from the date of manufacture.

For up-to-date warranty information, go to our web site at
<http://www.usa.lighting.philips.com/support/support/warranty>
or contact your local Philips sales representative.

5-Tap - An HID ballast that allows for a choice of five different input voltages.

AC (Alternating Current) - The common form of electricity from power plant to home/office. Its direction is reversed 60 times per second in the U.S.; 50 times in Europe.

AllnGaP - The preferred LED (Light Emitting Diode) chip technology containing Aluminum, Indium, Gallium, and Phosphorous to produce red, orange and amber-colors.

AllStart Technology - Philips proprietary, high efficacy, ceramic metal halide (CDM) lamp technology that allows this class of lamps to operate on either standard probe-start, or pulse-start magnetic ballasts. Consult Philips SAG-100 for lamp details.

Ambient Sound Levels - "Background noise" generated by electrical equipment operating in a building.

Ambient Temperature - Temperature of the atmosphere of the surrounding environment.

Ampere ("Amp") - A measure of electrical current.

ANSI (American National Standards Institute) - Group that generates voluntary product performance standards for many U.S. industries.

ANSI Watts - System wattage as measured utilizing a reference ballast and lamps on a bench top in open air as prescribed by ANSI C82.2.

Anti-Arc Circuit - Circuitry used to detect and limit arcing of ballast output leads.

Anti-Striation Circuit - Circuitry used to detect and reduce striations or spiraling in energy saving lamps due to low temperature or low current operation.

Arc (Lamp) - Intense luminous discharge formed by the passage of electric current across a space between electrodes.

Auto-Restrike - Circuitry used to restart the lamps without resetting the power to the ballast.

Autotransformer - Tapped winding transformer that changes the voltage available to the voltage required by a particular load.

Ballast - Device for starting and regulating fluorescent and high intensity discharge lamps among other lamps.

Ballast Cycling - Undesirable condition under which the ballast turns lamps on and off (cycles) due to the overheating of the thermal switch inside the ballast. This may occur for a number of reasons, including but not limited to, incorrect lamps, improper voltage being supplied, high ambient temperature around the fixture, or the early stage of ballast failure.

Ballast Efficacy Factor (BEF) - Measure used to compare various lighting systems based upon light output and input power. Higher BEF is favorable. $BEF = \text{Ballast Factor} \times 100 / \text{Input Watts}$.

Ballast Factor - Measure of light output from lamp operated by commercial ballast, as compared to a laboratory standard reference ballast.

Ballast Losses - Power that is supplied to the ballast but is not converted into light energy.

Ballast Luminous Efficiency (BLE) - Measure used to compare ballast efficiency based upon lamp power and input power. $BLE = \text{Total Lamp Arc Power} / \text{Input Watts}$.

Ballast Noise "Hum" - Sound made by operating Core & Coil assemblies in both electromagnetic and electronic ballasts, generated by the vibration of laminations in the electromagnetic field that transforms the voltage and current used by discharge lamps. The sound made by high frequency electronic ballasts is lower and any noise made by models with electronic power factor correction circuits is inaudible.

Ballast Regulation - The ability of a ballast to control lamp wattage (and therefore light output) when subject to changes in line voltage.

Bin - In LED's, the systematic dividing of distribution of performance parameters (Flux, Color or CCT, and Vf) in to smaller groups that meet aesthetic requirements of the assembly.

Binning - The separation of LEDs subsequent to a production run for full manufactured, distribution in terms of color, flux and forward voltage.

Canadian Standards Association (CSA) - Association that generates product performance and safety standards for many Canadian industries.

Capacitor - Device in ballast that stores electrical energy.

Centigrade (C) - Celsius temperature scale where $0^{\circ}\text{C} = 32^{\circ}\text{F}$ and $100^{\circ}\text{C} = 212^{\circ}\text{F}$.

Chip - A very small square of semi-conducting material. Also known as a die, it is the active light-emitting component of an LED.

Circle E - Marking on ballast that shows compliance with Federal Ballast Energy Law (Public Law 100-357).

Coil - Windings of copper or aluminum wire surrounding a core in ballast.

Conformal Coating - Material that surrounds and adheres to components and protects them.

Constant Wattage Autotransformer (CWA) - An HID ballast in which the primary and secondary coils are electrically connected and a capacitor is required as part of the lamp (secondary) circuit.

Core - Component of electromagnetic ballast that is surrounded by the coil and comprised of steel laminations or solid ferrite material.

Core & Coil Ballast - Another term for electromagnetic ballast.

Crest Factor - Ratio of peak lamp current to RMS (average) lamp current.

CSA E - Fluorescent lamp ballast energy efficiency regulations in Canada SOR 2006-271.

Cycling - See 'Ballast Cycling'.

DC forward current - Continuous direct current applied which is constant over time.

Decibel (dB) - Unit of measurement of the volume of sounds.

Die - Chip: heart of the LED.

Digital Addressable Lighting Interface (DALI) - An industry standard digital protocol that allows components from different manufacturers (ballasts, sensors, controllers, etc.) to be mixed together seamlessly into complete systems.

Diode - A two-electrode device with an anode and a cathode that passes current in only one direction. It may be designed as an electron tube or as a semiconductor device.

Direct Current (DC) - An electrical current flowing steadily in one direction only.

Discharge Lamp - A light producing device that depends on an electric arc, rather than a filament, to create illumination.

Driver - Electronics used to power illumination sources also referred to as a ballast.

Efficacy - See 'System Efficacy'.

Electrode - See 'Filament'.

Electromagnetic Ballast - A low frequency (50 - 60 Hz.) ballast that uses a "Core & Coil" assembly to transform electrical energy (voltage and current) to start and operate fluorescent and high intensity discharge (HID) lamps.

Electromagnetic Interference(EMI) - Electrical interference (noise) generated by electrical and electronic devices. Levels generated by high frequency electronic devices are subject to regulation by the Federal Communications Commission (FCC). Two classifications exist Non-Consumer (also referred to as Class A or Commercial) and Consumer (also referred to as Class B or Residential).

Electronic Ballast - A ballast that, with the aid of electronic components converts 60 Hz. input voltage and current to high frequency (20 kHz to 60 kHz.) to operate fluorescent and high intensity discharge (HID) lamps.

Electronic Component - A device or part employed in an electronic circuit to obtain some desired electronic action.

Energy – Work done by an electrical system measured in watts.

EOL Protection Circuit – For all T5 and smaller lamps, operating parameters within the ballast that, when exceeded, will shutdown the ballast.

ETL – Independent Intertek Testing laboratory, which is an independent testing facility, that performs ballast testing.

Federal Communication Commission (FCC) – The U.S. federal agency that is charged with regulating electrical interference emissions of the electromagnetic spectrum. The regulation entitled, “Title 47 CFR Part 18” deals with electromagnetic interference (EMI) from all lighting devices operating at frequencies higher than 9 kilohertz (kHz).

Feedback Signal – A control signal which regulates power through the LED driver to produce various effects in LEDs.

Filament – Coated coil of special wire that emits electrons or light when heated.

Filament Voltage – Voltage applied to heat the lamp filament coil.

Fluorescent Lamp – Gas filled lamp in which light is produced by the interaction of an arc with phosphors lining the lamp’s glass tube.

Forward Current – Current through a diode in the direction of its greatest conduction.

Forward Voltage (VF) – The voltage across a diode for a given forward current.

Frequency – Rate of alteration in an AC current. Expressed in cycles per second or Hertz (Hz).

Fundamental Frequency – Lowest frequency in a complex waveform. Also known as first harmonic.

Harmonic Distortion – A measurement of the magnitude of voltage and current harmonics as compared with the amplitude of the fundamental frequency. Harmonic distortion can be generated by a load and fed back into the AC mains, causing distortion of the sinusoidal waveform.

Harmonics – Refers to components of the overall frequency, an integral multiple of the fundamental sinewave frequency.

Hertz (Hz) – Unit used to measure frequency (cycles per second) of alternating current or voltage.

High Frequency Electronic Ballast – In this book, refers to the operation of electronic ballasts as frequencies > 20,000 Hertz (20 kHz).

High Intensity Discharge (HID) Lamp – A discharge lamp containing an arc tube in which the active elements within (mercury, sodium, etc.) becomes vaporized (a gaseous state) within the electric arc stream to produce light.

High Light Output – Ballast with a nominal ballast factor of 1.18.

High Power Factor Ballast – A ballast in which the power factor is greater than 0.9 (90%). These ballasts require less line current than normal power factor ballast.

High Reactance Autotransformer Ballast (HX) – HID ballast used when the input voltage does not meet the starting voltage requirement for a lamp. The ballast will transform the input voltage to the required level.

Hot Restart Time – The time it takes a HID lamp to restart and reach 90% of its light output after going from on to off to on. Typical restart times are 1 to 2 minutes for HPS and 5 to 20 minutes for Metal Halide.

IEC (International Electrotechnical Commission) – Organization made up of national committees from over 60 countries that sets international electrical and electronics standards

IEEE (Institute of Electrical and Electronics Engineers) – Organization of engineers that establishes standards for electrical and electronics industries.

Ignitor (Starter) – A device used within the ballast circuit to generate high voltage electrical pulses needed to start high pressure sodium and some metal halide lamps.

Illuminating Engineering Society (IES) – A volunteer professional membership agency dedicated to the advancement of the art and science of illumination and its dissemination.

InGaN – The preferred LED (Light Emitting Diode) semiconductor technology containing Indium, Gallium, and Nitrogen to produce green, blue and white-colored LED light sources.

Input Power – See Input Watts.

Input Voltage – Voltage, provided by a power line or power supply, to the ballast or driver.

Input Watts – Total power input to the ballast that includes lamp watts and ballast losses.

Inrush Current – Initial surge of current when an electrical device is turned on.

Instant Start Ballast – Electromagnetic or electronic lighting circuit without lamp filament heating that produces instant light.

Insulation Detector – See definition “Self Heating Thermal Protector”.

IntelliVolt – Multi-voltage feature of Philips Advance electronic ballasts that allow the ballast to operate from a nominal input voltage range of 120 – 277V at nominal frequencies of 50 or 60 Hz.

Kilohertz (kHz) – One thousand Hertz (cycles per second).

Laminations – Layers of steel, making up the ballast “core” that is surrounded by the coils in a core & coil ballast.

Lamp – The lighting industry term for light bulb. It refers to the complete assembly including the internal parts as well as the outer bulb or tube and base(s).

Lamp Current – The current delivered to the lamp by the ballast to generate light.

Lamp Current Crest Factor – See “Crest Factor.”

Lamp Watts (Rated) – The power consumed by the lamp to generate light.

Lead-Lag Slimline Ballast – Ballast that operate fluorescent lamps independently of one another. Can start lamps at 0°F.

LED Driver – See ‘Driver’.

Light – Radiant energy that can be sensed or seen by the human eye. Visible light is measured in lumens.

Light Emitting Diode (LED) – A solid-state semiconductor device that converts electrical energy directly into light. On its most basic level, the semiconductor is comprised of two regions. The p-region contains positive electrical charges while the n-region contains negative electrical charges. When voltage is applied and current begins to flow, the electrons move across the n region into the p region. The process of an electron moving through the p-n junction releases energy. The dispersion of this energy produces photons with visible wavelengths.

Line Current – See Ampere.

Low Power Factor – See ‘Normal Power Factor’.

Low Voltage Control – DC voltage used for signaling purposes.

Low Watt – Ballast with a nominal ballast factor of 0.78 or less.

Lumens – Measurement of light emitted by a lighted lamp.

Luminaire – A complete lighting fixture consisting of a lamp (or lamps), ballast(or ballasts) as required, together with the parts designed to distribute the light, position and protect the lamp, and connect them to the incoming power.

National Electric Code (NEC) – Electrical installation code developed by the National Fire Protection Association to reduce the risk of fire, which use is commonly mandated by state or local law in the U.S.

National Electrical Manufacturers Association (NEMA) – U.S. based association that sets many common standards used in electrical products.

NOM (Normas Oficial Mexicana) – Laboratory that sets safety standards for building materials, electrical appliances and other products for Mexico.

Normal Light Output - Ballast with a nominal ballast factor of 0.88 for most T8 ballasts, and 1.00 for most T5 and dimming ballasts.

Normal Power Factor - Ballast in which the power factor is less than 0.80 (80%). These ballasts require about twice the line current of high power factor ballasts.

Open Circuit Voltage [OCV] - Voltage, as measured at the lamp socket (HID or CFL) or across the lamp holders (fluorescent) when the lamp is not present, generated by the ballast needed to start a lamp when power is turned on.

Operating Position or Burn Position - The orientation of a lamp in a lighting fixture such as base up, base down, horizontal, or universal.

Packaged LED - Consists of the die, a lead frame, which houses the die, the encapsulation epoxy that protectively surrounds the die, and also disperses the light.

Parallel LED - Electrical condition where LEDs operate under the same voltage being provided by a driver.

Parallel Circuit - Ballast circuit in which the lamps connected to one ballast operate independently of one another - if one lamp fails, the rest remain lit.

PCB (Polychlorinated Biphenyls) - An organic compound that was used in ballasts manufactured prior to 1979. The ballast industry transitioned to non-PCB capacitors in or about 1979.

Potting - Compound used to completely surround and cover components of some magnetic and electronic ballasts in order to protect components, dampen sound, and dissipate heat.

Power - The amount of energy consumed or needed by a device (ballast, lamp, or ballast plus lamp) to perform its function. Power is measured in watts.

Power Factor (PF) - A measurement of how efficiently an electrical device uses power supplied by the power line. $PF = \text{Watts} / (\text{Volts} \times \text{Amps})$.

Power Factor Corrected (PFC) - Ballast with a power factor from 0.80 to 0.89.

Powerline Control - Method of dimming control where the phase of the sine wave is 'chopped' to dim the lamps.

Preheat Ballast - Electromagnetic ballast that requires a separate starter in order to ignite the lamp.

Probe Start - Method of starting mercury vapor and specific metal halide lamps in which an additional electrode at one end of the arc tube assists in lamp starting.

Programmed Start Ballast - An electronic lighting circuit similar to rapid start that provides precise heating of the lamp filaments and tightly controls the preheat duration before applying starting voltage to ignite the lamp.

Pulse Start - Method of starting high pressure sodium and specific metal halide lamps in which a high voltage starting pulse starts the lamps.

Quadri-Volt (Quad-Tap) - Feature within a ballast which gives you a choice of 4 different input voltages.

Rank - See 'Bin'.

Rapid Start Ballast - Electromagnetic or electronic ballast that provides both filament heating and starting voltage to the lamp at the same time in order to ignite the lamp.

Reference Ballast (standard reactor) - Laboratory device used to provide ANSI specified measurements of initial and mean lamp lumens.

Regulation, Lamp Wattage - The measure of the ability of a ballast or ballast circuit type to control (regulate) a lamp's operating wattage as the input voltage varies from nominal. It is the ratio of the percent change in line voltage (input voltage) divided by the resultant percent change in lamp wattage.

Reverse Current - Current flowing through a diode in the direction opposite to the direction of maximum conduction.

Reverse Voltage - Voltage across the diode for a given reverse current.

RoHS - Short for Directive on the restriction of the use of certain hazardous substances in electrical and electronic equipment, was adopted in February 2003 by the European Union.

RFI (Radio Frequency Interference) - Form of electromagnetic interference.

Series (LED) - Electrical condition where LEDs operate under the same current being provided by a driver.

Self Heating Thermal Protector - An add-on device required by various electrical codes for recessed downlight luminaires. This device is designed to shut power to the luminaire when the exterior luminaire surface reaches a defined temperature limit to prevent fire.

Series Circuit - Ballast circuit in which the lamps connected to one ballast operate as a group. If one lamp fails or is removed, then all lamps in the circuit turn off.

Series-Sequence Slimline Ballast - Ballasts that operate with lamps starting in sequence.

Series-Parallel Circuit - Ballast circuit in which the lamps connected to one ballast operate both as a group and independently. If one lamp fails or is removed in the series connected section, then all lamps in that section will turn off, but the lamps in the parallel circuit remain on.

Sine Wave - A mathematical function used to represent voltage and current.

Sound Rating - Classification given to a ballast based upon ballast noise.

Starting Temperature - The minimum ambient temperature at which the lamp will start. Light output may be affected due to lamp characteristics.

Striation - Spiraling or swirling of fluorescent lamps at initial turn on mostly with energy-saving lamps at low temperature or low current.

System Efficacy - Overall efficiency of the lamp/ballast system. $\text{System efficacy} = \text{total lamp lumens} / \text{system wattage}$.

Thermal Protector - A self-resetting switch that disconnects power to the ballast if internal temperatures rise above the trip point (typically 105°C).

Third Harmonic - Third multiple of the fundamental frequency that will add in the neutral wire of a three phase, 4 wire, Wye system and could cause over heating of the neutral wire should it exceed 33 1/3 percent.

Three-Phase, Four-Wire Wye - Most popular electrical wiring system used today for commercial building.

Total Harmonic Current (THC) - The combined effect of all of the harmonic distortion on the AC waveform produced by a ballast or other device. Excessive levels of THC can create large currents on the neutral line of a 3 phase 4 wire wye power system. See Total Harmonic Distortion.

Total Harmonic Distortion (THD) - Total Harmonic Current (THC) expressed as a percentage.

Transients - High voltage and resultant high current surges through an electrical system caused by lightning strikes to nearby transformers, overhead lines or the ground. May also be caused by switching of large motors or other electrical loads, as well as by short circuits or utility system switching. Can lead to premature failure of ballasts or other electrical devices.

Trigger Start Ballast - Electromagnetic ballast that starts and operates preheat lamps similar to a rapid start lamp. No separate starter is needed to ignite the lamp.

UL (Underwriters' Laboratories, Inc.) - A not for profit organization in the US that generates product performance and safety standards for electrical equipment, building materials, and other products. End use products such as lighting fixtures, fully encased ballasts, and home appliances are examples of products that may be listed with UL and may bear the UL logo.

UR (UL Recognized) - A part or subassembly covered under UL's Recognition Service and intended for factory installation in UL certified products. They are intended for use as components of complete equipment submitted for investigation by UL.

Voltage - A measurement of the electromotive force (electrical pressure) in an electrical circuit or device expressed in volts. Voltage can be thought of as being analogous to the pressure in a plumbing system.

Voltage Sag - Drop in voltage levels of electrical distribution system that interferes with the operation of electrical and electronic equipment. Commonly called "Brownout". Results when demand for electricity exceeds capacity of the distribution system.

Watt - The unit of measurement of electrical power.
Watts = Volts x Amps x Power Factor

Fluorescent/HID Ballast Specification for Lighting

Electronic Fluorescent

- Centium Micro Can
- Centium T5
- Centium T8, T12 and FT5
- Optanium T5
- Optanium T8
- SmartMate
- AmbiStar
- signPRO
- PowrKut
- PureVOLT
- Optanium Step-Dim
- Mark 7 0-10V
- Mark 10 Powerline
- ROVR

Magnetic HID (Including Metal Halide, High Pressure Sodium, and Low Pressure Sodium)

Electronic HID (Metal Halide)

- e-Vision and MasterColor Elite Medium Wattage
- CosmoPolis Xtreme

Corporate Offices
(800) 322-2086

Customer Support/Technical Service
(800) 372-3331 • (+) 1 847 390-5000 (International)

Visit our web site at www.philips.com/oemna.

Ballast Specification for Electronic Fluorescent

Centium Micro Can

Section I - Physical Characteristics

- 1.1 Ballast shall be physically interchangeable with standard electromagnetic or standard electronic ballasts, where applicable.
- 1.2 Ballast shall be provided with integral leads color-coded per ANSI C82.11.

Section II - Performance Requirements

- 2.1 Ballast shall be Instant Start.
- 2.2 Ballast shall contain auto restart circuitry in order to restart lamps without resetting power.
- 2.3 Ballast shall operate from 50/60 Hz input source of 120V through 277V with sustained variations of +/- 10% (voltage and frequency).
- 2.4 Ballast shall be high frequency electronic type and operate lamps at a frequency above 42 kHz to avoid interference with infrared devices and eliminate visible flicker.
- 2.5 Ballast shall have a Power Factor greater than 0.98 for primary lamp.
- 2.6 Ballast shall have a minimum ballast factor for primary lamp application as follows: 0.75 for Low Watt, 0.85 for Normal Light Output, and 1.20 for High Light.
- 2.7 Ballast shall provide for a Lamp Current Crest Factor of 1.7 or less.
- 2.8 Ballast input current shall have Total Harmonic Distortion (THD) of less than 10% when operated at nominal line voltage with primary lamp.
- 2.9 Ballast shall have a Class A sound rating.
- 2.10 Ballast shall have a minimum starting temperature of -18C (0F) for standard T8 lamps and 16C (60F) for energy-saving T8 lamps.
- 2.11 Ballast shall provide Lamp EOL Protection Circuit.
- 2.12 Ballast shall tolerate sustained open circuit and short circuit output conditions.

Section III - Regulatory

- 3.1 Ballast shall not contain any Polychlorinated Biphenyl (PCB).
- 3.2 Ballast shall be Underwriters Laboratories (UL) listed, Class P and Type 1 Outdoor; and Canadian Standards Association (CSA) certified where applicable.
- 3.3 Ballast shall comply with ANSI C62.41 Category A for Transient protection.
- 3.4 Ballast shall comply with ANSI C82.11 where applicable.
- 3.5 Ballast shall comply with applicable requirements of the Federal Communications Commission (FCC) rules and regulations, Title 47 CFR part 18, for Non-Consumer equipment.
- 3.6 Ballast shall comply with NEMA 410 for in-rush current limits.

Section IV - Other

- 4.1 Ballast shall be manufactured in a factory certified to ISO 9001 Quality System Standards.
- 4.2 Ballast shall carry a _____ year limited warranty from date of manufacture against defects in material or workmanship for operation at a maximum case temperature of _____ (Go to our web site for up-to-date warranty information: <http://www.usa.lighting.philips.com/support/support/warranty>).
- 4.3 Manufacturer shall have a twenty-year history of producing electronic ballasts for the North American market.
- 4.4 Ballast shall be Philips Advance part # _____ or approved equal.

Ballast Specification for Electronic Fluorescent

Centium T5

Section I - Physical Characteristics

- 1.1 Ballast shall be physically interchangeable with standard electromagnetic or standard electronic ballasts, where applicable.
- 1.2 Ballast shall be provided with color-coded integral leads or connectors per ANSI C82.11.

Section II - Performance Requirements

- 2.1 Ballast shall be Programmed Start.
- 2.2 Ballast shall contain auto restart circuitry in order to restart lamps without resetting power.
- 2.3 Ballast shall operate from 50/60 Hz input source of 120V through 277V or 347V or 347V through 480V with sustained variations of +/- 10% (voltage and frequency) with no damage to the ballast.
- 2.4 Ballast shall be high frequency electronic type and operate lamps at a frequency between 42 kHz and 52kHz to avoid interference with infrared devices, eliminate visible flicker and avoid Article Surveillance Systems, such as anti-theft devices.
- 2.5 Ballast shall have a Power Factor greater than 0.98 for primary lamp.
- 2.6 Ballast shall have a minimum ballast factor of 1.0 for primary lamps.
- 2.7 Ballast shall provide for a Lamp Current Crest Factor of 1.7 or less in accordance with lamp manufacturer recommendations.
- 2.8 Ballast input current shall have Total Harmonic Distortion (THD) of less than 10% when operated at normal line voltage with full load primary lamps.
- 2.9 Ballast shall have a Class A sound rating.
- 2.10 Ballast shall have a minimum starting temperature of -18°C (0°F) or -29°C (-20°F) or 0°C (32°F) for primary lamp.
- 2.11 Ballast shall provide Lamp EOL Protection.
- 2.12 Ballast shall tolerate sustained open circuit and short circuit output conditions without damage.

Section III - Regulatory

- 3.1 Ballast shall not contain any Polychlorinated Biphenyl (PCB).
- 3.2 Ballast shall be Underwriters Laboratories (UL) listed, Class P and Type 1 Outdoor; and Canadian Standards Association (CSA) certified where applicable.
- 3.3 Ballast shall comply with ANSI C62.41 Category A for transient protection.
- 3.4 Ballast shall comply with ANSI C82.11 where applicable.
- 3.5 Ballast shall comply with the requirements of the Federal Communications Commission (FCC) rules and regulations, Title 47 CFR part 18, Non-Consumer (Class A) for EMI/RFI (conducted and radiated).
- 3.6 Ballast shall comply with UL Type CC rating.
- 3.7 Ballast shall comply with NEMA 410 for in-rush current limits.

Section IV - Other

- 4.1 Ballast shall be manufactured in a factory certified to ISO 9001 Quality System Standards.
- 4.2 Ballast shall carry a _____ year limited warranty from date of manufacture against defects in material or workmanship for operation at a maximum case temperature of _____ (Go to our web site for up-to-date warranty information: <http://www.usa.lighting.philips.com/support/support/warranty>).
- 4.3 Manufacturer shall have a twenty-year history of producing electronic ballasts for the North American market.
- 4.4 Ballast shall be Philips Advance part # _____ or approved equal.

Ballast Specification for Electronic Fluorescent

Centium T8, T12 & FT5

Section I - Physical Characteristics

- 1.1 Ballast shall be physically interchangeable with standard electromagnetic or standard electronic ballasts, where applicable.
- 1.2 Ballast shall be provided with integral leads color-coded per ANSI C82.11.

Section II - Performance Requirements

- 2.1 Ballast shall be _____ (Instant, Rapid or Programmed start).
- 2.2 Ballast shall provide Independent Lamp Operation (ILO) for Instant Start ballasts allowing remaining lamp(s) to maintain full light output when one or more lamps fail.
- 2.3 Ballast shall contain auto restart circuitry in order to restart lamps without resetting power (except for T8/HO ballasts).
- 2.4 Ballast shall operate from 50/60 Hz input source of 120V through 277V with sustained variations of +/- 10% (voltage and frequency).
- 2.5 Ballast shall be high frequency electronic type and operate lamps at a frequency above 42 kHz to avoid interference with infrared devices and eliminate visible flicker.
- 2.6 Ballast shall have a Power Factor greater than 0.98 for primary lamp.
- 2.7 Ballast shall have a minimum ballast factor for primary lamp application as follows: 0.75 for Low Watt, 0.85 for Normal Light Output, and 1.20 for High Light.
- 2.8 Ballast shall provide for a Lamp Current Crest Factor of 1.7 or less.
- 2.9 Ballast input current shall have Total Harmonic Distortion (THD) of less than 10% when operated at nominal line voltage with primary lamp.
- 2.10 Ballast shall have a Class A sound rating.
- 2.11 Ballast shall have a minimum starting temperature of _____ [-18C (0F) for standard T8 and Long Twin Tube lamps, 10C (50F) for standard T12 lamps, 0C (32F) for Slimline T8 lamps -29C (-20F) for T8/HO lamps] for primary lamp application. Ballast shall have a minimum starting temperature of 16C (60F) for energy-saving T8 and T12 lamps.
- 2.12 Ballast shall tolerate sustained open circuit and short circuit output conditions.
- 2.13 Ballast for T8 lamps shall provide lamp striation-reduction circuitry.
- 2.14 Ballast for FT5 lamps shall provide Lamp EOL Protection Circuit.

Section III - Regulatory

- 3.1 Ballast shall not contain any Polychlorinated Biphenyl (PCB).
- 3.2 Ballast shall be Underwriters Laboratories (UL) listed, Class P and Type 1 Outdoor; and Canadian Standards Association (CSA) certified where applicable.
- 3.3 Ballast shall comply with ANSI C62.41 Category A for Transient protection.
- 3.4 Ballast shall comply with ANSI C82.11 where applicable.
- 3.5 Ballast shall comply with applicable requirements of the Federal Communications Commission (FCC) rules and regulations, Title 47 CFR part 18, for Non-Consumer equipment.
- 3.6 Ballast shall comply with NEMA 410 for in-rush current limits.

Section IV - Other

- 4.1 Ballast shall be manufactured in a factory certified to ISO 9001 Quality System Standards.
- 4.2 Ballast shall carry a _____ year limited warranty from date of manufacture against defects in material or workmanship for operation at a maximum case temperature of _____ (Go to our web site for up-to-date warranty information: <http://www.usa.lighting.philips.com/support/support/warranty>).
- 4.3 Manufacturer shall have a twenty-year history of producing electronic ballasts for the North American market.
- 4.4 Ballast shall be Philips Advance part # _____ or approved equal.

Ballast Specification for Electronic Fluorescent

Optanium T5

Section I - Physical Characteristics

- 1.1 Ballast shall be physically interchangeable with standard electromagnetic or standard electronic ballasts, where applicable.
- 1.2 Ballast shall be provided with integral leads color-coded per ANSI C82.11.

Section II - Performance Requirements

- 2.1 Ballast shall be Programmed Start.
- 2.2 Ballast shall provide Independent Lamp Operation (ILO) for Programmed Start Parallel ballasts allowing remaining lamp(s) to maintain full light output when one or more lamps fail.
- 2.3 Ballast shall operate from 50/60 Hz input source of _____ (120 through 277V or 347V or 347 through 480V) with sustained variations of +/- 10% (voltage and frequency).
- 2.4 Ballast shall be high frequency electronic type and operate lamps at a frequency between 42 kHz and 52kHz to avoid interference with infrared devices, eliminate visible flicker and avoid Article Surveillance Systems, such as anti-theft devices.
- 2.5 Ballast shall have a Power Factor greater than 0.98 for primary lamp.
- 2.6 Ballast shall have a minimum ballast factor for primary lamp application as follows: 1.0 for primary T5HO lamp or 0.95 or 1.15 for primary T5HE lamp.
- 2.7 Ballast shall provide for a Lamp Current Crest Factor of 1.7 or less.
- 2.8 Ballast input current shall have Total Harmonic Distortion (THD) of less than 10% when operated at nominal line voltage with primary lamp.
- 2.9 Ballast shall have a Class A sound rating for all 4-foot lamps and smaller.
- 2.10 Ballast shall have a minimum starting temperature of -29C (-20F) or -18C (0F) or 0C (32F) for primary lamp. Consult lamp manufacturer for temperature versus light output characteristics.
- 2.11 Ballast shall tolerate sustained open circuit and short circuit output conditions.
- 2.12 Programmed Start ballast shall provide lamp EOL protection circuitry.

Section III - Regulatory

- 3.1 Ballast shall not contain any Polychlorinated Biphenyl (PCB).
- 3.2 Ballast shall be Underwriters Laboratories (UL) listed, Class P and Type 1 Outdoor; and Canadian Standards Association (CSA) certified where applicable.
- 3.3 Ballast shall comply with ANSI C62.41 Category A for Transient protection.
- 3.4 Ballast shall comply with ANSI C82.11 where applicable.
- 3.5 Ballast shall comply with applicable requirements of the Federal Communications Commission (FCC) rules and regulations, Title 47 CFR part 18, for Non-Consumer equipment.
- 3.6 Ballast shall meet NEMA/CEE High Performance T8 Lighting System Specifications.
- 3.7 Ballast shall comply with UL Type CC rating.
- 3.8 Ballast shall comply with NEMA 410 for in-rush current limits.

Section IV - Other

- 4.1 Ballast shall be manufactured in a factory certified to ISO 9001 Quality System Standards.
- 4.2 Ballast shall carry a _____ year limited warranty from date of manufacture against defects in material or workmanship for operation at a maximum case temperature of _____ (Go to our web site for up-to-date warranty information: <http://www.usa.lighting.philips.com/support/support/warranty>).
- 4.3 Manufacturer shall have a twenty-year history of producing electronic ballasts for the North American market.
- 4.4 Ballast shall be Philips Advance part # _____ or approved equal.

Ballast Specification for Electronic Fluorescent

Optanium T8

Section I - Physical Characteristics

- 1.1 Ballast shall be physically interchangeable with standard electromagnetic or standard electronic ballasts, where applicable.
- 1.2 Ballast shall be provided with integral leads color-coded per ANSI C82.11.

Section II - Performance Requirements

- 2.1 Ballast shall be _____ (Instant or Programmed) Start.
- 2.2 Ballast shall provide Independent Lamp Operation (ILO) for Instant Start and Programmed Start Parallel ballasts allowing remaining lamp(s) to maintain full light output when one or more lamps fail.
- 2.3 Ballast shall operate from 50/60 Hz input source of _____ (120 through 277V or 347V or 347 through 480V) with sustained variations of +/- 10% (voltage and frequency).
- 2.4 Ballast shall be high frequency electronic type and operate lamps at a frequency between 42 kHz and 52kHz to avoid interference with infrared devices, eliminate visible flicker and avoid Article Surveillance Systems, such as anti-theft devices.
- 2.5 Ballast shall have a Power Factor greater than 0.98 for primary lamp.
- 2.6 Ballast shall have a minimum ballast factor for primary lamp application as follows: 0.77 for Low Watt, 0.87 for Normal Light Output, and 1.18 for High Light for Instant Start ballasts or 0.71 for Low Watt and 0.88 for Normal Light Output and 1.18 for High Light for Programmed Start ballasts.
- 2.7 Ballast shall provide for a Lamp Current Crest Factor of 1.7 or less.
- 2.8 Ballast input current shall have Total Harmonic Distortion (THD) of less than 10% when operated at nominal line voltage with primary lamp.
- 2.9 Ballast shall have a Class A sound rating for all 4-foot lamps and smaller.
- 2.10 Ballast shall have a minimum starting temperature of -29C (-20F) on Instant Start ballasts or -18C (0F) on Programmed Start ballasts for standard T8 lamps and 16C (60F) for energy-saving T8 lamps. Consult lamp manufacturer for temperature versus light output characteristics.
- 2.11 Ballast shall tolerate sustained open circuit and short circuit output conditions.

- 2.12 Ballast shall have lamp striation-reduction circuitry.
- 2.13 Programmed Start ballast shall provide lamp EOL protection circuitry.

Section III - Regulatory

- 3.1 Ballast shall not contain any Polychlorinated Biphenyl (PCB).
- 3.2 Ballast shall be Underwriters Laboratories (UL) listed, Class P and Type 1 Outdoor; and Canadian Standards Association (CSA) certified where applicable.
- 3.3 Ballast shall comply with ANSI C62.41 Category A for Transient protection.
- 3.4 Ballast shall comply with ANSI C82.11 where applicable.
- 3.5 Ballast shall comply with applicable requirements of the Federal Communications Commission (FCC) rules and regulations, Title 47 CFR part 18, for Non-Consumer equipment.
- 3.6 Ballast shall meet NEMA/CEE High Performance T8 Lighting System Specifications.
- 3.7 IOP ballasts shall comply with UL Type CC rating.
- 3.8 Ballast shall comply with NEMA 410 for in-rush current limits.

Section IV - Other

- 4.1 Ballast shall be manufactured in a factory certified to ISO 9001 Quality System Standards.
- 4.2 Ballast shall carry a _____ year limited warranty from date of manufacture against defects in material or workmanship for operation at a maximum case temperature of _____ (Go to our web site for up-to-date warranty information: <http://www.usa.lighting.philips.com/support/support/warranty>).
- 4.3 Manufacturer shall have a twenty-year history of producing electronic ballasts for the North American market.
- 4.4 Ballast shall be Philips Advance part # _____ or approved equal.

Ballast Specification for Electronic Fluorescent

SmartMate

Section I - Physical Characteristics

- 1.1 Ballast shall be physically interchangeable with standard electromagnetic or standard electronic ballasts, where applicable.
- 1.2 Ballast shall be available in a plastic/metal can or all metal can construction to meet plenum requirements.
- 1.3 Ballast shall be provided with poke-in wire trap connectors color-coded per ANSI C82.11.

Section II - Performance Requirements

- 2.1 Ballast shall be Programmed Start except for ballasts with -QS suffix, which shall be Rapid Start.
- 2.2 Ballast shall contain auto restart circuitry in order to restart lamps without resetting power.
- 2.3 Ballast shall operate from 50/60 Hz input source of 120V through 277V with sustained variations of +/- 10% (voltage and frequency).
- 2.4 Ballast shall be high frequency electronic type and operate lamps at a frequency above 42 kHz to avoid interference with infrared devices and eliminate visible flicker.
- 2.5 Ballast shall have a Power Factor greater than 0.98 for primary lamp.
- 2.6 Ballast shall have a minimum ballast factor of 1.00 for primary lamp.
- 2.7 Ballast shall provide for a Lamp Current Crest Factor of 1.7 or less.
- 2.8 Ballast input current shall have Total Harmonic Distortion (THD) of less than 10% when operated at nominal line voltage with primary lamp.
- 2.9 Ballast shall have a Class A sound rating.
- 2.10 Ballast shall have a minimum starting temperature of -18C (0F) for primary lamp.
- 2.11 Ballast shall provide Lamp EOL Protection Circuit.
- 2.12 Ballast shall tolerate sustained open circuit and shortcircuit output conditions.

Section III - Regulatory

- 3.1 Ballast shall not contain any Polychlorinated Biphenyl (PCB).
- 3.2 Ballast shall be Underwriters Laboratories (UL) listed, Class P and Type 1 Outdoor; and Canadian Standards Association (CSA) certified where applicable.
- 3.3 Ballast shall be rated for use in air-handling spaces.
- 3.4 Ballast shall comply with ANSI C62.41 Category A for transient protection.
- 3.5 Ballast shall comply with ANSI C82.11 where applicable.
- 3.6 Ballast shall comply with applicable requirements of the Federal Communications Commission (FCC) rules and regulations, Title 47 CFR part 18, for Non-Consumer equipment.
- 3.7 Ballast shall comply with NEMA 410 for in-rush current limits.

Section IV - Other

- 4.1 Ballast shall be manufactured in a factory certified to ISO 9001 Quality System Standards.
- 4.2 Ballast shall carry a _____ year limited warranty from date of manufacture against defects in material or workmanship for operation at a maximum case temperature of _____ (Go to our web site for up-to-date warranty information: <http://www.usa.lighting.philips.com/support/support/warranty>).
- 4.3 Manufacturer shall have a twenty-year history of producing electronic ballasts for the North American market.
- 4.4 Ballast shall be Philips Advance part # _____ or approved equal.

Ballast Specification for Electronic Fluorescent

AmbiStar

Section I - Physical Characteristics

- 1.1 Ballast shall be physically interchangeable with standard electromagnetic or standard electronic ballasts, where applicable.
- 1.2 Ballast shall be provided with integral leads or poke-in wire trap connectors color-coded per ANSI C82.11.

Section II - Performance Requirements

- 2.1 Ballast shall be _____ (Instant or Rapid) Start.
- 2.2 Ballast shall provide Independent Lamp Operation (ILO) for Instant Start ballasts allowing remaining lamp(s) to maintain full light output when one or more lamps fail.
- 2.3 Ballast shall contain auto restart circuitry in order to restart lamps without resetting power
- 2.4 Ballast shall operate from 60 Hz input source of 120V with sustained variations of +/- 10% (voltage and frequency).
- 2.5 Ballast shall be high frequency electronic type and operate lamps at a frequency above 42 kHz to avoid interference with infrared devices and eliminate visible flicker.
- 2.6 Ballast shall have a Power Factor for primary lamp as follows: greater than 0.98 for RCF and RELB models or greater than 0.50 for REB models.
- 2.7 Ballast shall have a minimum ballast factor of 0.85 for primary lamp.
- 2.8 Ballast shall provide for a Lamp Current Crest Factor of 1.7 or less.
- 2.9 Ballast input current shall have Total Harmonic Distortion (THD) when operated at nominal line voltage with primary lamp as follows: less than 10% for RCF models, less than 20% for RELB models or less than 150% for REB models.
- 2.10 Ballast shall have a Class A sound rating.
- 2.11 Ballast shall have a minimum starting temperature for primary lamp as follows: 0°F/-18°C for RCF, REB models or 50°F/10°C for standard T12 lamps and 60°F/16°C for energy-saving T12 lamps.
- 2.12 Ballast shall provide Lamp EOL Protection Circuit for CFL.
- 2.13 Ballast shall tolerate sustained open circuit and short circuit output conditions.

Section III - Regulatory

- 3.1 Ballast shall not contain any Polychlorinated Biphenyl (PCB).
- 3.2 Ballast shall be Underwriters Laboratories (UL) listed, Class P and Type 1 Outdoor; and Canadian Standards Association (CSA) certified where applicable.
- 3.3 Ballast for CFL lamps shall be rated for use in air-handling spaces.
- 3.4 Ballast shall comply with ANSI C62.41 Category A for Transient protection.
- 3.5 Ballast shall comply with ANSI C82.11 where applicable.
- 3.6 Ballast shall comply with applicable requirements of the Federal Communications Commission (FCC) rules and regulations, Title 47 CFR part 18, for Non-Consumer equipment.
- 3.7 Ballast shall comply with NEMA 410 for in-rush current limits.

Section IV - Other

- 4.1 Ballast shall be manufactured in a factory certified to ISO 9001 Quality System Standards.
- 4.2 Ballast shall carry a _____ year limited warranty from date of manufacture against defects in material or workmanship for operation at a maximum case temperature of _____ (Go to our web site for up-to-date warranty information: <http://www.usa.lighting.philips.com/support/support/warranty>).
- 4.3 Manufacturer shall have a twenty-year history of producing electronic ballasts for the North American market.
- 4.4 Ballast shall be Philips Advance part # _____ or approved equal.

Ballast Specification for Electronic Fluorescent

signPRO

Section I - Physical Characteristics

- 1.1 Ballast shall be physically interchangeable with standard electromagnetic or standard electronic ballasts, where applicable.
- 1.2 Ballast shall be provided with integral leads color-coded per ANSI C82.11.

Section II - Performance Requirements

- 2.1 Ballast shall be Instant Start.
- 2.2 Ballast shall provide Independent Lamp Operation (ILO) for Instant Start ballasts allowing remaining lamp(s) to maintain full light output when one or more lamps fail.
- 2.3 Ballast shall contain auto restart circuitry in order to restart lamps without resetting power..
- 2.4 Ballast shall operate from 50/60 Hz input source of 120V through 277V with sustained variations of +/- 10% (voltage and frequency).
- 2.5 Ballast shall be high frequency electronic type and operate lamps at a frequency above 42 kHz to avoid interference with infrared devices and eliminate visible flicker.
- 2.6 Ballast shall have a Power Factor greater than 0.98 for primary lamp.
- 2.7 Ballast shall have a minimum ballast factor for primary lamp application as follows: 0.60 for T12/HO and 0.80 for T8/HO.
- 2.8 Ballast shall provide for a Lamp Current Crest Factor of 1.7 or less.
- 2.9 Ballast input current shall have Total Harmonic Distortion (THD) of less than 10% when operated at nominal line voltage with primary lamp.
- 2.10 Ballast shall have a Class A sound rating.
- 2.11 Ballast shall have a minimum starting temperature of -29C (-20F) for primary lamp.
- 2.12 Ballast shall tolerate sustained open circuit and short circuit output conditions.

Section III - Regulatory

- 3.1 Ballast shall not contain any Polychlorinated Biphenyl (PCB).
- 3.2 Ballast shall be Underwriters Laboratories (UL) listed, Class P and Type 2 Outdoor; and Canadian Standards Association (CSA) certified where applicable.
- 3.3 Ballast shall comply with ANSI C62.41 Category A for Transient protection.
- 3.4 Ballast shall comply with ANSI C82.11 where applicable.
- 3.5 Ballast shall comply with applicable requirements of the Federal Communications Commission (FCC) rules and regulations, Title 47 CFR part 18, for Non-Consumer equipment.
- 3.6 Ballast shall comply with NEMA 410 for in-rush current limits.

Section IV - Other

- 4.1 Ballast shall be manufactured in a factory certified to ISO 9001 Quality System Standards.
- 4.2 Ballast shall carry a _____ year limited warranty from date of manufacture against defects in material or workmanship for operation at a maximum case temperature of _____ (Go to our web site for up-to-date warranty information: <http://www.usa.lighting.philips.com/support/support/warranty>).
- 4.3 Manufacturer shall have a twenty-year history of producing electronic ballasts for the North American market.
- 4.4 Ballast shall be Philips Advance part # _____ or approved equal.

Ballast Specification for Electronic Fluorescent

PowrKut

Section I - Physical Characteristics

- 1.1 Ballast shall be physically interchangeable with standard electromagnetic or standard electronic ballasts, where applicable.
- 1.2 Ballast shall be provided with integral leads color-coded per ANSI C82.11.

Section II - Performance Requirements

- 2.1 Ballast shall be Rapid Start.
- 2.2 Ballast shall contain auto restart circuitry in order to restart lamps without resetting power.
- 2.3 Ballast shall operate from 60 Hz input source of 120V or 277V as applicable with sustained variations of +/- 10% (voltage and frequency).
- 2.4 Ballast shall operate lamps at a frequency of 60 Hz.
- 2.5 Ballast shall have a Power Factor greater than 0.90 for primary lamp.
- 2.6 Ballast shall have a minimum ballast factor of 0.85 for primary lamp
- 2.7 Ballast shall provide for a Lamp Current Crest Factor of 1.7 or less.
- 2.8 Ballast input current shall have Total Harmonic Distortion (THD) of less than 20% when operated at nominal line voltage with primary lamp.
- 2.9 Ballast shall have a Class A sound rating.
- 2.10 Ballast shall have a minimum starting temperature of 10C (50F) for primary lamp.
- 2.11 Ballast shall tolerate sustained open circuit and shortcircuit output conditions.

Section III - Regulatory

- 3.1 Ballast shall not contain any Polychlorinated Biphenyl (PCB).
- 3.2 Ballast shall be Underwriters Laboratories (UL) listed, Class P and Type 1 Outdoor; and Canadian Standards Association (CSA) certified where applicable.
- 3.3 Ballast shall comply with ANSI C62.41 Category A for transient protection.
- 3.4 Ballast shall comply with ANSI C82.11 where applicable.
- 3.5 Ballast shall comply with applicable requirements of the Federal Communications Commission (FCC) rules and regulations, Title 47 CFR part 18, for Non-Consumer equipment

Section IV - Other

- 4.1 Ballast shall be manufactured in a factory certified to ISO 9001 Quality System Standards.
- 4.2 Ballast shall carry a _____ year limited warranty from date of manufacture against defects in material or workmanship for operation at a maximum case temperature of _____ (Go to our web site for up-to-date warranty information: <http://www.usa.lighting.philips.com/support/support/warranty>).
- 4.3 Manufacturer shall have a twenty-year history of producing electronic ballasts for the North American market.
- 4.4 Ballast shall be Philips Advance part # _____ or approved equal.

Ballast Specification for Electronic Fluorescent

PureVOLT

Section I - Physical Characteristics

- 1.1 Ballast shall be physically interchangeable with standard electromagnetic or standard electronic ballasts, where applicable.
- 1.2 Ballast shall be provided with integral leads color-coded per ANSI C82.11.

Section II - Performance Requirements

- 2.1 Ballast shall be Programmed Start.
- 2.2 Ballast shall contain auto restart circuitry in order to restart lamps without resetting power.
- 2.3 Ballast shall operate from 50/60 Hz input source of 120V through 277V with sustained variations of +/- 10% (voltage and frequency).
- 2.4 Ballast shall be high frequency electronic type and operate lamps at a frequency above 42 kHz to avoid interference with infrared devices and eliminate visible flicker.
- 2.5 Ballast shall have a Power Factor greater than 0.96 for primary lamp.
- 2.6 Ballast shall provide for a Lamp Current Crest Factor of 1.7 or less.
- 2.7 Ballast input current shall have Total Harmonic Distortion (THD) of less than 10% when operated at nominal line voltage with primary lamp.
- 2.8 Ballast shall have a Class A sound rating.
- 2.9 Ballast shall have a minimum starting temperature of -18C (0F) for primary lamp.
- 2.10 Ballast shall provide Lamp EOL Protection Circuit.
- 2.11 Ballast shall tolerate sustained open circuit and shortcircuit output conditions.

Section III - Regulatory

- 3.1 Ballast shall not contain any Polychlorinated Biphenyl (PCB).
- 3.2 Ballast shall be Underwriters Laboratories (UL) listed, Class P and Type 1 Outdoor; and Canadian Standards Association (CSA) certified where applicable.
- 3.3 Ballast shall be rated for use in air-handling spaces.
- 3.4 Ballast shall comply with ANSI C62.41 Category A for Transient protection.
- 3.5 Ballast shall comply with ANSI C82.11 where applicable.
- 3.6 Ballast shall comply with applicable requirements of the Federal Communications Commission (FCC) rules and regulations, Title 47 CFR part 18, for Non-Consumer equipment.
- 3.7 Ballast shall comply with NEMA 410 for in-rush current limits.

Section IV - Other

- 4.1 Ballast shall be manufactured in a factory certified to ISO 9001 Quality System Standards.
- 4.2 Ballast shall carry a _____ year limited warranty from date of manufacture against defects in material or workmanship for operation at a maximum case temperature of _____ (Go to our web site for up-to-date warranty information: <http://www.usa.lighting.philips.com/support/support/warranty>).
- 4.3 Manufacturer shall have a twenty-year history of producing electronic ballasts for the North American market.
- 4.4 Ballast shall be Philips Advance part # _____ or approved equal.

Ballast Specification for Controllable Light Output Electronic Fluorescent

Optanium Step-Dim

Section I - Physical Characteristics

- 1.1 Ballast shall be physically interchangeable with standard electromagnetic or standard electronic ballasts, where applicable.
- 1.2 Ballast shall be provided with integral leads color-coded per ANSI C82.11.

Section II - Performance Requirements

- 2.1 The ballast shall be Programmed Start.
- 2.2 The ballast shall contain auto restart circuitry in order to restart lamps without resetting power.
- 2.3 Ballast shall operate from 50/60 Hz input source of 120V through 277V with sustained variations of +/- 10% (voltage and frequency).
- 2.4 Ballast shall be high frequency electronic type and operate lamps at a frequency above 42 kHz to avoid interference with infrared devices and eliminate visible flicker.
- 2.5 Ballast shall have a Power Factor greater than 0.98 at 100% power and greater than 0.90 at 50% power for primary lamp.
- 2.6 Ballast shall have a ballast factor for primary lamp as follows: 0.87 for T8 lamp or 0.95 or 1.15 for T5HE lamp or 1.0 for T5HO lamp.
- 2.7 Ballast shall provide for a Lamp Current Crest Factor of 1.7 or less.
- 2.8 Ballast input current shall have Total Harmonic Distortion (THD) of less than 10% when operated at nominal line and 100% power.
- 2.9 Ballast shall have a Class A sound rating.
- 2.10 Ballast shall have a minimum starting temperature of -18C (0F) for standard T8 and T5HE lamps or 16C (60F) for energy-saving T8 lamps or 0C (32F) for standard T5HO lamps or 10C (50F) for energy-saving T5HO lamps.
- 2.11 Ballast shall tolerate sustained open circuit and short circuit output conditions.
- 2.12 Ballast shall provide Lamp EOL Protection Circuit for T5 lamps.
- 2.13 Ballast shall control light output in two steps: 100% power and 50% power. Control shall be any device that switches the line voltage input. Both line voltage inputs must be on the same phase.
- 2.14 Ballast shall ignite the lamps at any light output setting without first going to another output setting.

Section III - Regulatory

- 3.1 Ballast shall not contain any Polychlorinated Biphenyl (PCB).
- 3.2 Ballast shall be Underwriters Laboratories (UL) listed, Class P and Type 1 Outdoor; and Canadian Standards Association (CSA) certified where applicable.
- 3.3 Ballast shall comply with ANSI C62.41 Category A for Transient protection.
- 3.4 Ballast shall comply with ANSI C82.11 where applicable.
- 3.5 Ballast shall comply with applicable requirements of the Federal Communications Commission (FCC) rules and regulations, Title 47 CFR part 18, for Non-Consumer equipment.
- 3.6 Ballast shall comply with UL Type CC rating.
- 3.7 Ballast shall comply with NEMA 410 for in-rush current limits

Section IV - Other

- 4.1 Ballast shall be manufactured in a factory certified to ISO 9001 Quality System Standards.
- 4.2 Ballast shall carry a _____ year limited warranty from date of manufacture against defects in material or workmanship for operation at a maximum case temperature of _____ (Go to our web site for up-to-date warranty information: <http://www.usa.lighting.philips.com/support/support/warranty>).
- 4.3 Manufacturer shall have a twenty-year history of producing electronic ballasts for the North American market.
- 4.4 Ballast shall be Philips Advance part # _____ or approved equal.

Ballast Specification for Controllable Light Output Electronic Fluorescent

Mark 7 O-10V

Section I - Physical Characteristics

- 1.1 Ballast shall be physically interchangeable with standard electromagnetic or standard electronic ballasts, where applicable.
- 1.2 Ballast shall be available in a plastic/metal can or all metal can construction to meet all plenum requirements.
- 1.3 Ballast shall be provided with poke-in wire trap connectors or integral leads color coded per ANSI C82.11.

Section II - Performance Requirements

- 2.1 Ballast shall be Programmed Start.
- 2.2 Ballast shall provide Independent Lamp Operation (ILO) for Programmed Start Parallel ballasts allowing remaining lamp(s) to maintain full light output when one or more lamps fail.
- 2.3 Ballast shall be provided with integral protection circuitry to withstand connection of low voltage control leads to mains power supply. In this event, ballast shall default to maximum light output.
- 2.4 Ballast shall contain auto restart circuitry in order to restart lamps without resetting power.
- 2.5 Ballast shall operate from 50/60 Hz input source of 120V or 277V or 347V with sustained variations of +/- 10% (voltage and frequency). IntelliVolt models shall operate from 50/60 Hz input source of 120V through 277V with sustained variations of +/- 10% (voltage and frequency).
- 2.6 Ballast shall be high frequency electronic type and operate lamps at a frequency above 42 kHz to avoid interference with infrared devices and eliminate visible flicker.
- 2.7 Ballast shall have a Power Factor greater than 0.98 at full light output and greater than 0.90 throughout the dimming range for primary lamp.
- 2.8 Ballast shall have a minimum ballast factor of 1.00 (120V and 277V 1-3 lamp models) or 0.88 (120V and 277V 4 lamp models and 347V 2-3 lamp models) or 1.18 (277V 4 lamp HL models) at maximum light output and 0.03 at minimum light output for primary lamp.
- 2.9 Ballast shall provide for a Lamp Current Crest Factor of 1.7 or less.
- 2.10 Ballast input current shall have Total Harmonic Distortion (THD) of less than 10% when operated at nominal line voltage and 100% power.

- 2.11 Ballast shall have a Class A sound rating.
- 2.12 Ballast shall have a minimum starting temperature of 10°C (50°F) for primary lamp.
- 2.13 Ballast shall provide Lamp EOL Protection Circuit for all T5, T5/ HO and CFL lamps.
- 2.14 Ballast shall control lamp light output from 100% - 3% relative light output for series operation T8 and CFL lamps, 100% - 10% relative light output for parallel operation T8 and 100% - 1% relative light output for T5/HO lamps.
- 2.15 Ballast shall ignite the lamps at any light output setting without first going to another output setting.
- 2.16 Ballast shall tolerate sustained open circuit and short circuit output conditions.

Section III - Regulatory

- 3.1 Ballast shall not contain any Polychlorinated Biphenyl (PCB).
- 3.2 Ballast shall be Underwriters Laboratories (UL) listed, Class P and Type 1 Outdoor; and Canadian Standards Association (CSA) certified where applicable.
- 3.3 Ballast shall comply with ANSI C62.41 Category A for Transient protection.
- 3.4 Ballast shall comply with ANSI C82.11 where applicable.
- 3.5 Ballast shall comply with the requirements of the Federal Communications Commission (FCC) rules and regulations, Title 47 CFR part 18, Non-Consumer (Class A) for EMI/RFI (conducted and radiated).
- 3.6 Ballast shall comply with NEMA 410 for in-rush current limits.

Section IV - Other

- 4.1 Ballast shall be manufactured in a factory certified to ISO 9001 Quality System Standards.
- 4.2 Ballast shall carry a _____ year limited warranty from date of manufacture against defects in material or workmanship for operation at a maximum case temperature of _____ (Go to our web site for up-to-date warranty information: <http://www.usa.lighting.philips.com/support/support/warranty>).
- 4.3 Manufacturer shall have a twenty-year history of producing electronic ballasts for the North American market.
- 4.4 Ballast shall be Philips Advance part # _____ or approved equal.

Ballast Specification for Controllable Light Output Electronic Fluorescent

Mark 10 Powerline

Section I - Physical Characteristics

- 1.1 Ballast shall be physically interchangeable with standard electromagnetic or standard electronic ballasts, where applicable.
- 1.2 Ballast shall be available in a plastic/metal can or all metal can construction to meet all plenum requirements.
- 1.3 Ballast shall be provided with poke-in wire trap connectors or integral leads color coded per ANSI C82.11.

Section II - Performance Requirements

- 2.1 Ballast shall be Programmed Start.
- 2.2 Ballast shall contain auto restart circuitry in order to restart lamps without resetting power.
- 2.3 Ballast shall operate from 60 Hz input source of 120V or 277V as applicable with sustained variations of +/- 10% (voltage and frequency).
- 2.4 Ballast shall be high frequency electronic type and operate lamps at a frequency above 42 kHz to avoid interference with infrared devices and eliminate visible flicker.
- 2.5 Ballast shall have a Power Factor greater than 0.98 at full light output and greater than 0.90 throughout the dimming range for primary lamp.
- 2.6 Ballast shall have a minimum ballast factor of 1.00 at maximum light output and 0.05 at minimum light output for primary lamp application.
- 2.7 Ballast shall provide for a Lamp Current Crest Factor of 1.7 or less.
- 2.8 Ballast input current shall have Total Harmonic Distortion (THD) of less than 10% at maximum light output when operated at nominal line voltage with primary lamp. Total Harmonic Current (THC) at minimum light output shall not exceed THC at maximum light output.
- 2.9 Ballast shall have a Class A sound rating.
- 2.10 Ballast shall have a minimum starting temperature of 10° C (50° F) for primary lamp.
- 2.11 Ballast shall provide Lamp EOL Protection Circuit for all T5, T5/ HO, and CFL lamps.
- 2.12 Ballast shall control lamp light output from 100% - 5% relative light output for T8 and CFL lamps and 100% - 1% relative light output for T5/HO lamps.

- 2.13 Ballast shall ignite the lamps at any light output setting without first going to another output setting.
- 2.14 Ballast shall tolerate sustained open circuit and short circuit output conditions.

Section III - Regulatory

- 3.1 Ballast shall not contain any Polychlorinated Biphenyl (PCB).
- 3.2 Ballast shall be Underwriters Laboratories (UL) listed, Class P and Type 1 Outdoor; and Canadian Standards Association (CSA) certified where applicable.
- 3.3 Ballast shall comply with ANSI C62.41 Category A for Transient protection.
- 3.4 Ballast shall comply with ANSI C82.11 where applicable.
- 3.5 Ballast shall comply with the requirements of the Federal Communications Commission (FCC) rules and regulations, Title 47 CFR part 18, Non-Consumer (Class A) for EMI/RFI (conducted and radiated).
- 3.6 Ballast shall comply with NEMA 410 for in-rush current limits.

Section IV - Other

- 4.1 Ballast shall be manufactured in a factory certified to ISO 9001 Quality System Standards.
- 4.2 Ballast shall carry a _____ year limited warranty from date of manufacture against defects in material or workmanship for operation at a maximum case temperature of _____ (Go to our web site for up-to-date warranty information: <http://www.usa.lighting.philips.com/support/support/warranty>).
- 4.3 Manufacturer shall have a twenty-year history of producing electronic ballasts for the North American market.
- 4.4 Ballast shall be Philips Advance part # _____ or approved equal.

Ballast Specification for Controllable Light Output Electronic Fluorescent

ROVR

Section I - Physical Characteristics

- 1.1 Ballast shall be physically interchangeable with standard electromagnetic or standard electronic ballasts, where applicable.
- 1.2 Ballast shall be available in a plastic/metal can or all metal can construction to meet all plenum requirements.
- 1.3 Ballast shall be provided with poke-in wire trap connectors or integral leads color coded per ANSI C82.11.

Section II - Performance Requirements

- 2.1 Ballast shall be Programmed Start.
- 2.2 Ballast shall be provided with integral protection circuitry to withstand connection of low voltage control leads to mains power supply. In this event, ballast shall default to maximum light output.
- 2.3 Ballast shall contain auto restart circuitry in order to restart lamps without resetting power.
- 2.4 Ballast shall operate from 50/60Hz input source of 120V or 277V with sustained variations of +/-10% (voltage and frequency) with no damage to the ballast. IntelliVolt models shall operate from 50/60Hz input source of 120V through 277V with sustained variations of +/-10% (voltage and frequency) with no damage to the ballast.
- 2.5 Ballast shall be high frequency electronic type and operate lamps at a frequency above 42kHz to avoid interference with infrared devices and eliminate visible flicker.
- 2.6 Ballast shall have a Power Factor greater than 0.98 at full light output and greater than 0.90 throughout the dimming range for primary lamp.
- 2.7 Ballast shall have a minimum ballast factor of 1.00 at maximum light output and 0.03 at minimum light output for primary lamp.
- 2.8 Ballast shall provide for a Lamp Current Crest Factor of 1.7 or less throughout the dimming range in accordance with lamp manufacturer recommendations.
- 2.9 Ballast input current shall have Total Harmonic Distortion (THD) of less than 10% when operated at nominal line voltage with primary lamp.
- 2.10 Ballast shall have a Class A sound rating.
- 2.11 Ballast shall have a minimum starting temperature of 10°C (50° F) for primary lamp.
- 2.12 Ballast shall provide Lamp EOL Protection Circuit for all T5, T5/HO, and CFL lamps.

- 2.13 Ballast shall control lamp light output from 100% - 3% relative light output for T8 and CFL lamps and 100% - 1% relative light output for T5/HO lamps.
- 2.14 Ballast shall ignite the lamps at any light output setting without first going to another output setting.
- 2.15 Ballast shall tolerate sustained open circuit and short circuit output conditions without damage.

Section III - Regulatory

- 3.1 Ballast shall not contain any Polychlorinated Biphenyl (PCB).
- 3.2 Ballast shall be Underwriters Laboratories (UL) listed, Class P and Type 1 Outdoor; and Canadian Standards Association (CSA) certified where applicable.
- 3.3 Ballast shall comply with ANSI C62.41 Category A for Transient protection.
- 3.4 Ballast shall comply with ANSI C82.11 where applicable.
- 3.5 Ballast shall comply with the requirements of the Federal Communications Commission (FCC) rules and regulations, Title 47 CFR part 18, Non-Consumer (Class A) for EMI/RFI (conducted and radiated).
- 3.6 Ballast shall comply with NEMA 410 for in-rush current limits.

Section IV - Other

- 4.1 Ballast shall be manufactured in a factory certified to ISO 9001 Quality System Standards.
- 4.2 Ballast shall carry a _____ year limited warranty from date of manufacture against defects in material or workmanship for operation at a maximum case temperature of _____ (Go to our web site for up-to-date warranty information: <http://www.usa.lighting.philips.com/support/support/warranty>).
- 4.3 Manufacturer shall have a twenty-year history of producing electronic ballasts for the North American market.
- 4.4 Ballast shall be controlled by a Class 1 or Class 2 low voltage DALI controller.
- 4.5 Ballast shall be Philips Advance part # _____ or approved equal.

Magnetic HID

Ballast Specification for Magnetic HID Ballasts

Metal Halide, High Pressure Sodium & Low Pressure Sodium

Performance Requirements:

1. Ballasts shall be designed in accordance with all applicable ANSI specifications including ANSI C82.4.
2. The Core & Coil ballast shall be designed with class "H" (180°C) or higher insulation system and vacuum-pressure impregnated with a silica-filled polyester resin.
3. All coils shall be precision wound.
4. Core & Coil ballasts shall be designed to operate for 60,000 hours of continuous operation at their maximum rated temperature.
5. Core & Coil ballasts and starter combinations shall be designed to provide a reliable lamp starting down to -40°C for High Pressure Sodium and -30°C for Metal Halide at nominal line voltage of plus or minus 10%.
6. All HID ballast shall have a nominal ballast factor of 1.0
7. All HID ballasts shall contain no exposed live parts.

Other

1. Ballast shall be manufactured in an ISO 9001 and ISO 14001 Certified Facility.
2. Ballast shall carry a 2-year limited warranty from date of manufacture against defects in material or workmanship. (Go to our website for up-to-date warranty information: <http://www.usa.lighting.philips.com/support/support/warranty>).
3. Manufacturer shall have been manufacturing HID ballasts for at least twenty-five years.
4. All HID ballasts shall be UL component recognized.
5. All HID ballasts shall be CSA certified.
6. Ballast must be a Philips Advance branded ballast (or approved equal).

Capacitors for HID

1. All capacitors will be provided with a self-contained internal bleeder resistor where required according to UL1029.
2. Oil-filled capacitors will be housed in aluminum or corrosion resistant steel cans and contain .25" quick disconnect terminals.
3. Oil filled capacitors shall have a 90°C max case temperature rating.
4. Dry film capacitors shall have a 105°C max. case

temperature rating.

5. All dry film capacitors provided by the ballast manufacturer have been tested and approved for use with the manufacturer's ballast.
6. All capacitors rated 400V or less shall be dry film type.
7. All dry film capacitors shall have no exposed live parts.

Ignitors for HID

1. All ignitors will be polyester resin-filled with either a plastic or aluminum external housing.
2. The ignitor shall be so designed to provide six months of lamp open circuit operation without failure.
3. All ignitors shall have a case rating temperature of 105°C.
4. All ignitors shall be designed to withstand 10,000 hours of continuous pulsing.
5. All ignitors shall have no exposed live parts.

HID Retrofit Kits

1. All HID kits shall be precision wound to insure proper insulation.
2. All HID kits shall be pre-wired with ignitors.
3. HID core and coil shall be interchangeable with prior ballast or include mounting bracket to adapt ballast to intended fixture.
4. All HID kits shall be supplied with pre-insulated input voltage leads.
5. All HID kits are to be UL and CSA recognized following the guidelines found in UL 1029 and CAN/CSA-22.2 No. 74-92 (part 2 and 3).
6. The core & coil shall be designed with class "H" (180°C) or higher insulation system and vacuum-pressure impregnated with a silica-filled polyester resin.
7. All capacitors rated 400V or less shall be dry film type rated 105°C.
8. There are to be no exposed live parts on the core & coil, ignitor, or dry capacitor.
9. Must meet applicable ANSI Specifications for the specified lamp.
10. Kit must include installation instructions and a 1-800# for field assistance.
11. Ballast must be Philips Advance Part # _____ (or approved equal).

Electronic HID (Metal Halide)

Ballast Specification for Electronic Metal Halide

e-Vision Electronic Ballasts

Section I - Physical Characteristics

- 1.1 The electronic ballast shall be furnished with integral, color-coded leads.
- 1.2 The electronic ballast shall be furnished with a metallic enclosure for maximum thermal dissipation.

Section II - Performance

- 2.1 The electronic ballast shall be IntelliVolt[®] and operate from a nominal line voltage range of 120-277 volts, +/-10%, 50/60 Hz unless stated otherwise.
- 2.2 The electronic ballast input current shall have Total Harmonic Distortion (THD) of less than 15%.
- 2.3 The electronic ballast shall have a Power Factor greater than 90%.
- 2.4 The electronic ballast shall have a lamp end-of-life detection and shutdown circuit. Power to ballast shall be disconnected to reset end-of-life detection circuit.
- 2.5 The electronic ballast shall be Sound Rated A.
- 2.6 The electronic ballast output frequency to the lamps shall be less than 200 Hz to prevent acoustic resonance inside the lamp arc tube and to minimize visible flicker.
- 2.7 The electronic ballast shall provide a "Lamp Current Crest Factor" of less than 1.5.
- 2.8 The electronic ballast shall be thermally protected to shut off when operating temperatures reach unacceptable levels.

Section III - Regulatory

- 3.1 The electronic ballast shall meet the requirements of the Federal Communications Commission rules and regulations, Title 47 CFR part 18, for Non-Consumer equipment.
- 3.2 The electronic ballast shall be Underwriters Laboratories (UL) Listed and CSA Certified where applicable.
- 3.3 Ballast shall comply with ANSI C62.41 Category A for transient protection.

Section IV - Other

- 4.1 The electronic ballast shall not contain Polychlorinated Biphenyl (PCB's).
- 4.2 Ballast shall carry a 3-year limited warranty from date of manufacture against defects in material or workmanship when operated at marked case temperature (Go to our website for up-to-date warranty information: <http://www.usa.lighting.philips.com/support/support/warranty>).
- 4.3 The manufacturer shall have a twenty-five year history of producing HID lamp ballasts for the North American market.
- 4.4 The electronic ballast shall be produced in a factory certified to ISO 9001 Quality System Standards
- 4.5 The electronic ballast shall comply with RoHS.

Section V - Additional Specifications for MasterColor Elite Medium Wattage (IZTMH210315RLF and HZTMH210315RLF)

- 5.1 Ballast must automatically reduce lamp power to lower its operating temperature when its internal operating temperature increases beyond its maximum limit.
- 5.2 Ballast must be approved by Philips to operate MasterColor CDM Elite Medium Wattage Lamps.
- 5.3 Ballast must include a 0-10V dimming interface and control the dimming function such that the CDM Elite MW lamp is allowed to warm up for 10 minutes at full power before the lamp is allowed to dim, regardless of the level of the 0-10V dimming signal.
- 5.4 Ballast shall dim the lamp from 100% to 50% power in 30 seconds and shall be able to restore power to 100% in 3 seconds maximum.

Electronic HID (Metal Halide)

Ballast Specification for Electronic Metal Halide

CosmoPolis Xtreme Electronic Ballasts

Applicable to all Ballast Catalog Numbers beginning with ICW, IDCW, RCW

Section I - Physical Characteristics

- 1.1 The electronic ballast shall be made of a polymeric housing and double insulated with a double isolated functional ground to protect metal parts of the luminaire from becoming live in any normal operating or fault mode.
- 1.2 The electronic ballast shall incorporate integral wiring connectors with push button wire entrapment.

Section II - Performance

- 2.1 The electronic ballast shall have a minimum starting temperature of -30°C (-22°F) and maximum case temperature of 90°C (194°F)
- 2.2 The electronic ballast shall have integral common mode surge protection of 10kV/5kA (combination wave) and differential mode surge protection of 2kV (IEEE 62.41.2)
- 2.3 The electronic ballast shall be suitable for use up to $+55^{\circ}\text{C}$ ambient conditions.
- 2.4 The electronic ballast shall operate from a nominal line voltage range of either 208-277V or 120V as applicable, 50/60Hz, $\pm 10\%$.
- 2.5 The electronic ballast shall have a Total harmonic Distortion (THD) of 15% or less.
- 2.6 The electronic ballast shall have an input power factor of 90% or greater.
- 2.7 The electronic ballast shall have a lamp end-of-life detection and shutdown circuit. Power to ballast shall be disconnected to reset the shutdown circuit.
- 2.8 The electronic ballast shall be sound rated A.
- 2.9 The electronic ballast steady state output frequency to the lamps shall be less than 200Hz to prevent acoustic resonance in the lamps resulting in premature failure.
- 2.10 The electronic ballast shall be thermally protected to shut down the ballast and lamp if temperatures reach unacceptable levels.
- 2.11 The electronic ballast must have a rated average life of 80,000 hours or operation.

Section III - Regulatory

- 3.1 The electronic ballast shall be UL Recognized and CSA Recognized.
- 3.2 The electronic ballast shall be approved by Philips to operate Philips CosmoPolis lamps.
- 3.3 The electronic ballast shall be RoHS compliant.

Section IV - Other

- 4.1 The electronic ballast shall be provided with a 5-year limited warranty from date of manufacture against defects in material or workmanship when operated within its maximum rated case temperature. (refer to our website for updated warranty information, <http://www.usa.lighting.philips.com/support/support/warranty>)
- 4.2 The electronic ballast manufacturer must have a twenty five year history of producing HID lamp ballasts for the North American market.
- 4.3 The electronic ballast shall not contain any Polychlorinated Biphenyls (PCBs).
- 4.4 The electronic ballast shall be produced in a factory certified to ISO 9001 Quality System Standards.

Catalog Number to Page Number *Lead Lengths and Shipping Data (Fluorescent Ballasts)*

Catalog Number	See Page No.	Lead Lengths for ballasts purchased in bulk or mid-pack cartons Tolerance: +2", -1"												Shipping Data		
		Black	White	Blue	Red	Yellow	Blue/White	Black/White	Yellow/Blue	Brown	Red/White	Orange	Orange/Black	Units Std. Ctn.	Weight Std. Ctn. (lbs.)	Avail IC* Ctn.
GCN-2S28-L	3-30, 3-31	23	23	27	27	48								10	10	
GOP-2PSP32-LW-SC	3-39, 3-40, 3-43, 3-44, 3-47, 3-48, 3-50, 3-51, 3-53, 3-54	25	25	33	33	48								20	24	
GOP-2PSP32-SC	3-39, 3-40, 3-43, 3-44, 3-47, 3-48, 3-50, 3-51, 3-53, 3-54	25	25	33	33	48								20	24	
GOP-3PSP32-SC	3-41, 3-45, 3-49, 3-52, 3-55	25	25	33	33	48	33							20	24	
GOP-4PSP32-LW-SC	3-41, 3-42, 3-45, 3-46, 3-49, 3-52, 3-55, 3-56	25	25	33	33	48	33		33					20	24	
GOP-4PSP32-SC	3-41, 3-42, 3-45, 3-49, 3-52, 3-55, 3-56	25	25	33	33	48	33		33					20	24	
GOPA-IP32-LW-SC	3-39, 3-43, 3-47, 3-50, 3-53		25	31	37				25					20	28	
GOPA-IP32-SC	3-39, 3-43, 3-47, 3-50, 3-53		25	31	37				25					20	28	
GOPA-2P32-LW-SC	3-39, 3-40, 3-43, 3-44, 3-47, 3-48, 3-50, 3-51, 3-53, 3-54, 3-57	25	25	31	37									20	28	
GOPA-2P32-SC	3-39, 3-40, 3-43, 3-44, 3-47, 3-48, 3-50, 3-51, 3-53, 3-54, 3-57	25	25	31	37									20	28	
GOPA-3P32-LW-SC	3-40, 3-41, 3-44, 3-45, 3-48, 3-49, 3-51, 3-52, 3-54, 3-55, 3-57	25	25	31	37									20	28	
GOPA-3P32-SC	3-40, 3-41, 3-44, 3-45, 3-48, 3-49, 3-51, 3-52, 3-54, 3-55, 3-57	25	25	31	37									20	28	
GOPA-4P32-LW-SC	3-41, 3-42, 3-45, 3-46, 3-49, 3-52, 3-55, 3-56, 3-58	25	25	31	37	39								20	28	
GOPA-4P32-SC	3-41, 3-42, 3-45, 3-46, 3-49, 3-52, 3-55, 3-56, 3-58	25	25	31	37	39								20	28	
GZT-2S32-SC ***	4-15	22	22	26	26	46								20	21	
GZT-3S32-SC ***	4-15	22	22	26	46	26	46							20	21	
H-1B13-TP-W	5-9		15	15					15					36	36	✓
H-1B9-TP-W	5-9		15	15					15					36	29	
H-1Q26-TP-W	5-9		15	15					15					20	46	✓
H-2B13-TP-BLS	5-9	7	7	7										20	36	
H-2Q26-TP-BLS	5-9	7	7	7										10	40	
HCN-2S54-90C-WL	3-27 to 29, 3-32 to 35			28	28	48		31				31		12	12	✓
HCN-4S54-90C-2LS-G	3-27 to 29, 3-33 to 35			54	51	60	42	32		60		42	32	6	18	✓
HM-IP20-TP	5-6		8	10	10			8						10	32	✓
HM-2SP20-TP	5-6	10	10	13	13	16								10	34	✓
HOP-2PSP32-HL-L	3-39, 3-40, 3-43, 3-44, 3-47, 3-48, 3-50, 3-51, 3-53, 3-54	32	32	29	29	49								10	12	
HOP-2PSP54-L	3-33 to 35			28	28	48		31				31		12	12	
HOP-4PSP32-HL-G	3-41, 3-42, 3-45, 3-46, 3-49, 3-52, 3-55, 3-56	32	32	33	33	48	33			33				6	7.2	
HOP-4PSP54-2LS-G	3-33 to 35			28	30		25	31	56	25			31	6	18	
ICF-1D38-HI-LD	3-25						No Leads - Poke in Connectors						20	8		
ICF-2S13-HI-LD	3-22, 3-23, 3-25						No Leads - Poke in Connectors						20	8		
ICF-2S13-HI-LD-K	3-22, 3-23, 3-25						No Leads - Poke in Connectors						20	8	✓	
ICF-2S13-MI-BS	3-22, 3-23, 3-25						No Leads - Poke in Connectors						16	6.4		
ICF-2S13-MI-BS-QS	3-22, 3-23, 3-25						No Leads - Poke in Connectors						16	6.4		
ICF-2S18-HI-LD	3-22, 3-23, 3-25						No Leads - Poke in Connectors						20	8		
ICF-2S18-HI-LD-K	3-22, 3-23, 3-25						No Leads - Poke in Connectors						20	8	✓	
ICF-2S18-MI-BS	3-22, 3-23, 3-25						No Leads - Poke in Connectors						16	6.4		
ICF-2S18-MI-BS-QS	3-22, 3-23						No Leads - Poke in Connectors						16	6.4		
ICF-2S26-HI-LD	3-22 to 25, 3-27						No Leads - Poke in Connectors						20	8		
ICF-2S26-HI-LD-K	3-22 to 25, 3-27						No Leads - Poke in Connectors						20	8	✓	
ICF-2S26-MI-BS	3-22 to 25, 3-27						No Leads - Poke in Connectors						16	6.4		
ICF-2S26-MI-BS-QS	3-22 to 24, 3-27						No Leads - Poke in Connectors						16	6.4		
ICF-2S42-90C-M2-BS	3-22 to 25, 3-27, 3-28, 3-32						No Leads - Poke in Connectors						16	13		
ICF-2S42-90C-M2-LD	3-22 to 25, 3-27, 3-28, 3-32						No Leads - Poke in Connectors						20	16		
ICF-2S42-M2-BS	3-22 to 25, 3-27, 3-28, 3-32						No Leads - Poke in Connectors						16	13		
ICF-2S42-M2-LD	3-22 to 25, 3-27, 3-28, 3-32						No Leads - Poke in Connectors						20	16		
ICF-2S42-M2-LD-K	3-22 to 25, 3-27, 3-28, 3-32						No Leads - Poke in Connectors						20	16	✓	
ICN-132-MC	3-39, 3-43, 3-53		25	31	37			25						20	15	✓
ICN-IP32-N	3-39, 3-43, 3-47, 3-50, 3-53		25	31	37			25						30	24	✓

* Electromagnetic ballasts packed in individual cartons (IC) have shorter leads, typically 12 inches. Electronic ballasts in individual cartons (IC) have same lead lengths as listed in table.

** Also includes 36" violet & grey control leads.

*** Also includes 32" violet & grey control leads

Catalog Number to Page Number *Lead Lengths and Shipping Data (Fluorescent Ballasts)*

Catalog Number	See Page No.	Lead Lengths for ballasts purchased in bulk or mid-pack cartons Tolerance: +2", -1"												Shipping Data		
		Black	White	Blue	Red	Yellow	Blue/White	Black/White	Yellow/Blue	Brown	Red/White	Orange	Orange/Black	Units Std. Ctn.	Weight Std. Ctn. (lbs.)	Avail IC* Ctn.
ICN-1S80-T	3-29, 3-35, 3-68	No Leads - Poke in Connectors												18	18	
ICN-1TTP40-SC	3-28		25	30	30			25						20	28	✓
ICN-2M32-MC	3-40, 3-44, 3-54	25	25	31	37									20	15	✓
ICN-2P32-N	3-39, 3-40, 3-43, 3-44, 3-47, 3-48, 3-50, 3-51, 3-53, 3-54, 3-57	24	24	28	43									30	24	✓
ICN-2P60-N	3-62	25	25	46	79									30	24	✓
ICN-2S110-SC	3-63	25	25	46	46	79								20	34	✓
ICN-2S24-N	3-27, 3-32, 3-33	25	25	27	27	42								30	24	
ICN-2S24-T	3-27, 3-32, 3-33	No Leads - Poke in Connectors												18	18	✓
ICN-2S28-85-N	3-30, 3-31	23	23	27	27	42								30	30	
ICN-2S28-N	3-30, 3-31	23	23	27	27	42								30	30	✓
ICN-2S28-T	3-30, 3-31	No Leads - Poke in Connectors												18	18	✓
ICN-2S39-N	3-27, 3-32, 3-33	25	25	27	27	42								30	24	
ICN-2S39-T	3-27, 3-32, 3-33	No Leads - Poke in Connectors												18	18	✓
ICN-2S40-N	3-61	25	25	31	31	46								30	30	✓
ICN-2S54-90C-N	3-27 to 29, 3-32 to 35, 3-68	35	35	31	32	52								30	24	✓
ICN-2S54-90C-T	3-27 to 29, 3-32 to 35, 3-68	No Leads - Poke in Connectors												18	18	✓
ICN-2S54-N	3-27 to 29, 3-32 to 35, 3-68	25	25	27	27	42								30	24	✓
ICN-2S54-T	3-27 to 29, 3-32 to 35, 3-68	No Leads - Poke in Connectors												18	18	✓
ICN-2S86-SC	3-60	22	22	46	46	70								20	26	✓
ICN-2TTP40-SC	3-28	25	25	30	30									20	28	✓
ICN-3P32-N	3-40, 3-41, 3-44, 3-45, 3-48, 3-49, 3-51, 3-52, 3-54, 3-55, 3-57	24	24	28	42									30	30	✓
ICN-3S14-T	3-30	No Leads - Poke in Connectors												18	18	
ICN-3TTP40-SC	3-28	25	25	30	30									20	28	✓
ICN-4P32-N	3-41, 3-42, 3-45, 3-46, 3-49, 3-52, 3-55, 3-56, 3-58	24	24	28	28	42								30	30	✓
ICN-4S54-90C-2LS-G	3-27 to 29, 3-33 to 35, 3-68	32	32	54	51	60	42			60		42		6	18	✓
IDA-128-D	4-20	No Leads - Poke in Connectors												12	12	
IDA-132-SC	4-22		22	46	26			22						20	15	
IDA-154	4-19, 4-21	No Leads - Poke in Connectors												12	12	
IDA-2S28-D	4-20	No Leads - Poke in Connectors												12	12	
IDA-2S32-SC	4-22	22	22	26	26	46								20	21	
IDA-2S54	4-19, 4-21	No Leads - Poke in Connectors												12	12	
IDA-3S32-G	4-22	22	22	28	54	28								6	18	
IDA-4S32	4-22	No Leads - Poke in Connectors												12	12	
IDL-2S26-M5-BS	4-18	No Leads - Poke in Connectors												16	14	
IDL-2S26-M5-LD	4-18	No Leads - Poke in Connectors												20	16	
IDL-2T42-M5-BS	4-18	No Leads - Poke in Connectors												16	14	
IDL-2T42-M5-LD	4-18	No Leads - Poke in Connectors												20	16	
IEZ-128-D	4-7	No Leads - Poke in Connectors												12	12	
IEZ-2S24-D	4-6, 4-8	No Leads - Poke in Connectors												12	12	
IEZ-2S28-D	4-7	No Leads - Poke in Connectors												12	12	
IOP-1P32-HL-N	3-39, 3-43, 3-47, 3-50, 3-53		25	31	37			25						30	24	
IOP-1P32-LW-N	3-39, 3-43, 3-47, 3-50, 3-53		25	31	37			25						30	24	
IOP-1P32-N	3-39, 3-43, 3-47, 3-50, 3-53		25	31	37			25						30	24	✓
IOP-1PSP32-LW-N	3-39, 3-43, 3-47, 3-50, 3-53		25	26	36			25						30	24	
IOP-1PSP32-N	3-39, 3-43, 3-47, 3-50, 3-53		25	26	36			25						30	24	
IOP-2P32-HL-N	3-39, 3-40, 3-43, 3-44, 3-47, 3-48, 3-50, 3-51, 3-53, 3-54, 3-57	25	25	31	37									30	24	✓
IOP-2P32-LW-N	3-39, 3-40, 3-43, 3-44, 3-47, 3-48, 3-50, 3-51, 3-53, 3-54, 3-57	25	25	31	37									30	24	✓
IOP-2P32-N	3-39, 3-40, 3-43, 3-44, 3-47, 3-48, 3-51, 3-53, 3-54, 3-57	25	25	31	37									30	24	✓
IOP-2P59-N	3-59	22	22	46	70									30	24	✓
IOP-2PSP32-HL-N	3-39, 3-40, 3-43, 3-44, 3-47, 3-48, 3-50, 3-51, 3-53, 3-54	25	25	33	33	48								30	24	
IOP-2PSP32-LW-N	3-39, 3-40, 3-43, 3-44, 3-47, 3-48, 3-50, 3-51, 3-53, 3-54	25	25	33	33	48								30	24	
IOP-2PSP32-N	3-39, 3-40, 3-43, 3-44, 3-47, 3-48, 3-50, 3-51, 3-53, 3-54	25	25	33	33	48								30	24	✓
IOP-2PSP49-HL-SC	3-33, 3-34															
IOP-2PSP54-SC	3-33 to 35	26	26	28	27	46								20	40	
IOP-2S28-115-SC	3-30, 3-31	22	22	28	26	36								20	20	

* Electromagnetic ballasts packed in individual cartons (IC) have shorter leads, typically 12 inches. Electronic ballasts in individual cartons (IC) have same lead lengths as listed in table.
 ** Also includes 36" violet & grey control leads.

Catalog Number to Page Number *Lead Lengths and Shipping Data (Fluorescent Ballasts)*

Catalog Number	See Page No.	Lead Lengths for ballasts purchased in bulk or mid-pack cartons Tolerance: +2", -1"												Shipping Data		
		Black	White	Blue	Red	Yellow	Blue/White	Black/White	Yellow/Blue	Brown	Red/White	Orange	Orange/Black	Units Std. Ctn.	Weight Std. Ctn. (lbs.)	Avail IC* Ctn.
IOP-2S28-115-SC-SD	4-2	(2) 22	22	26	26	36							20	20		
IOP-2S28-95-SC	3-30, 3-31	22	22	26	26	36							20	20		
IOP-2S28-95-SC-SD	4-2	(2) 22	22	26	26	36							20	20		
IOP-2S32-SC-SD	4-3	(2) 25	25	27	27	48							20	20		
IOP-2S54-L-SD	4-2	(2) 25	25	28	28	48							10	12		
IOP-3P32-HL-N	3-40, 3-41, 3-44, 3-45, 3-48, 3-49, 3-51, 3-52, 3-54, 3-55, 3-57	25	25	31	37								20	32		
IOP-3P32-HL-90C-N	3-40, 3-41, 3-44, 3-45, 3-48, 3-49, 3-51, 3-52, 3-54, 3-55, 3-57	25	25	31	37								30	24		
IOP-3P32-LW-N	3-40, 3-41, 3-44, 3-45, 3-48, 3-49, 3-51, 3-52, 3-54, 3-55, 3-57	25	25	31	37								20	28	✓	
IOP-3P32-N	3-40, 3-41, 3-44, 3-45, 3-48, 3-49, 3-51, 3-52, 3-54, 3-55, 3-57	25	25	31	37								20	28	✓	
IOP-3PSP32-HL-SC	3-40, 3-41, 3-44, 3-45, 3-48, 3-49, 3-51, 3-52, 3-54, 3-55	25	25	33	33	48	33						20	24		
IOP-3PSP32-LW-SC	3-40, 3-41, 3-44, 3-45, 3-48, 3-49, 3-51, 3-52, 3-54, 3-55	25	25	33	33	48	33						20	24	✓	
IOP-3PSP32-SC	3-40, 3-41, 3-44, 3-45, 3-48, 3-49, 3-51, 3-52, 3-54, 3-55	25	25	33	33	48	33						20	24	✓	
IOP-4P32-HL-90C-SC	3-41, 3-42, 3-45, 3-46, 3-49, 3-52, 3-55, 3-56, 3-58	25	25	31	31	39							20	20		
IOP-4P32-HL-SC	3-41, 3-42, 3-45, 3-46, 3-49, 3-52, 3-55, 3-56, 3-58	25	25	31	31	39							20	28		
IOP-4P32-LW-N	3-41, 3-42, 3-45, 3-46, 3-49, 3-52, 3-55, 3-56, 3-58	25	25	31	31	39							20	28	✓	
IOP-4P32-N	3-41, 3-42, 3-45, 3-46, 3-49, 3-52, 3-55, 3-56, 3-58	25	25	31	31	39							20	28	✓	
IOP-4PSP32-HL-G	3-41, 3-42, 3-45, 3-46, 3-49, 3-52, 3-55, 3-56	25	25	33	33	48	33		33				6	18		
IOP-4PSP32-LW-SC	3-41, 3-42, 3-45, 3-46, 3-49, 3-52, 3-55, 3-56	25	25	33	33	48	33		33				20	20	✓	
IOP-4PSP32-SC	3-41, 3-42, 3-45, 3-46, 3-49, 3-52, 3-55, 3-56	25	25	33	33	48	33		33				20	20	✓	
IOP-4PSP49-HL-G	3-33, 3-34															
IOP-4PSP54-2LS-G	3-33 to 35	26	26	28	30		25		56	25			6	18		
IOPA-1P32-HL-N	3-39, 3-43, 3-47, 3-50, 3-53		25	31	37				25				30	24		
IOPA-1P32-LW-N	3-39, 3-43, 3-47, 3-50, 3-53		25	31	37				25				30	24	✓	
IOPA-1P32-N	3-39, 3-43, 3-47, 3-50, 3-53		25	31	37				25				30	24	✓	
IOPA-2P32-HL-N	3-39, 3-40, 3-43, 3-44, 3-47, 3-48, 3-50, 3-51, 3-53, 3-54, 3-57	25	25	31	37								30	24		
IOPA-2P32-LW-N	3-39, 3-40, 3-43, 3-44, 3-47, 3-48, 3-50, 3-51, 3-53, 3-54, 3-57	25	25	31	37								30	24	✓	
IOPA-2P32-N	3-39, 3-40, 3-43, 3-44, 3-47, 3-48, 3-50, 3-51, 3-53, 3-54, 3-57	25	25	31	37								30	24	✓	
IOPA-3P32-HL-N	3-40, 3-41, 3-44, 3-45, 3-48, 3-49, 3-51, 3-52, 3-54, 3-55, 3-57	25	25	31	37								30	24		
IOPA-3P32-LW-N	3-40, 3-41, 3-44, 3-45, 3-48, 3-49, 3-51, 3-52, 3-54, 3-55, 3-57	25	25	31	37								30	24	✓	
IOPA-3P32-N	3-40, 3-41, 3-44, 3-45, 3-48, 3-49, 3-51, 3-52, 3-54, 3-55, 3-57	25	25	31	37								30	24	✓	
IOPA-4P32-LW-N	3-41, 3-42, 3-45, 3-46, 3-49, 3-52, 3-55, 3-56, 3-58	25	25	31	31	39							30	24	✓	
IOPA-4P32-N	3-41, 3-42, 3-45, 3-46, 3-49, 3-52, 3-55, 3-56, 3-58	25	25	31	31	39							30	24	✓	
ISB-0216-12-E	3-64	24	24	120	120								1	6		
ISB-0432-14-E	3-64	24	24	120	120	120			120				1	10		
ISB-0848-46-E	3-64	24	24	120	120	120			120				1	14		
ISB-1040-14-E	3-64	24	24	120	120	120			120				1	10		
IUV-2S18-HI-LD	3-67						No Leads - Poke in Connectors						20	8		
IUV-2S36-M2-LD	3-67						No Leads - Poke in Connectors						20	16		
IUV-2S60-M4-LD	3-67						No Leads - Poke in Connectors						20	26		
IZT-124-D	4-14						No Leads - Poke in Connectors						12	12		
IZT-128-D	4-13						No Leads - Poke in Connectors						12	12		
IZT-132-SC **	4-15		22	46	26			22					20	15	P	

* Electromagnetic ballasts packed in individual cartons (IC) have shorter leads, typically 12 inches. Electronic ballasts in individual cartons (IC) have same lead lengths as listed in table.

** Also includes 36" violet & grey control leads.

Catalog Number to Page Number *Lead Lengths and Shipping Data (Fluorescent Ballasts)*

Catalog Number	See Page No.	Lead Lengths for ballasts purchased in bulk or mid-pack cartons Tolerance: +2", -1"												Shipping Data		
		Black	White	Blue	Red	Yellow	Blue/White	Black/White	Yellow/Blue	Brown	Red/White	Orange	Orange/Black	Units Std. Ctn.	Weight Std. Ctn. (lbs.)	Avail IC* Ctn.
IZT-154-D	4-12, 4-14	No Leads - Poke in Connectors												12	12	
IZT-180-D	4-12, 4-14	No Leads - Poke in Connectors												12	12	
IZT-2PSP32-SC **	4-15	25	25	26	26	46							20	20	✓	
IZT-2S24-D	4-14	No Leads - Poke in Connectors												12	12	
IZT-2S26-M5-BS	4-11	No Leads - Poke in Connectors												16	14	
IZT-2S26-M5-LD	4-11	No Leads - Poke in Connectors												20	16	
IZT-2S28-D	4-13	No Leads - Poke in Connectors												12	12	
IZT-2S54-D	4-12, 4-14	No Leads - Poke in Connectors												12	12	
IZT-2T42-M5-BS	4-11	No Leads - Poke in Connectors												16	14	
IZT-2T42-M5-LD	4-11	No Leads - Poke in Connectors												20	16	
IZT-2TTS40-SC **	4-12	12	12	24	24	24							20	21		
IZT-3PSP32-SC **	4-15	25	25	26	46	46	46						20	20	✓	
IZT-4PSP32-G **	4-15	32	32	58	58	13	61				61		6	18		
IZT-4S32	4-15	No Leads - Poke in Connectors												12	12	
LC-13-TP	5-8	17		14									50	35	✓	
LC-14-20-C	5-4, 5-5	14, 17											50	30	✓	
LC-14-20-C-TP	5-4, 5-5	17		14									50	35	✓	
LC-25-TP	5-5, 5-8	18		22									50	35	✓	
LC-4-9-C	5-4	(2) 10											50	30	✓	
LO-13-22	5-4, 5-5	(2) 15											72	43		
LO-13-22-TP	5-8	15		15									72	43		
LOS-1Q28	5-8	(2) 15											72	58		
LPL-5-9	5-4	(2) 9											135	41		
LPL-5-9-TP	5-8	9		9									120	36	✓	
RC-2S102-TP	5-3	18	18	43	43	19							4	46	✓	
RC-2S200-TP	5-3	22	22	44	44	68							4	60	✓	
RCF-2S13-MI-BS-QS	3-22, 3-23	No Leads - Poke in Connectors												16	6.4	
RCF-2S18-MI-BS-QS	3-22, 3-23	No Leads - Poke in Connectors												16	6.4	
RCF-2S26-HI-LD-QS	3-22 TO 3-24	No Leads - Poke in Connectors												20	8	
RCF-2S26-MI-BS-QS	3-22 TO 3-24	No Leads - Poke in Connectors												16	6.4	
REB-2P32-N	3-40, 3-43, 3-44, 3-53, 3-54, 3-57	22	22	26	43								30	24		
REB-4P32-SC	3-41, 3-42, 3-45, 3-46, 3-55, 3-56	25	25	31	31	39							20	20		
RELB-2S40-N	3-61	22	22	26	26	36							30	30	✓	
REZ-132-SC	4-9		22	46	26				22				20	20	✓	
REZ-154	4-6, 4-8	No Leads - Poke in Connectors												12	12	
REZ-1Q18-M2-BS	4-5	No Leads - Poke in Connectors												16	14	
REZ-1T42-M2-BS	4-5	No Leads - Poke in Connectors												16	14	
REZ-1T42-M2-LD	4-5	No Leads - Poke in Connectors												20	16	
REZ-1T42-M2-LD-K	4-5	No Leads - Poke in Connectors												20	16	✓
REZ-1TTS40-SC	4-6		12	24	24				12				20	20		
REZ-2Q18-M2-BS	4-5	No Leads - Poke in Connectors												16	14	
REZ-2Q18-M2-LD	4-5	No Leads - Poke in Connectors												20	16	
REZ-2Q26-M2-BS	4-5	No Leads - Poke in Connectors												16	14	
REZ-2Q26-M2-LD	4-5	No Leads - Poke in Connectors												20	16	
REZ-2Q26-M2-LD-K	4-5	No Leads - Poke in Connectors												20	16	✓
REZ-2S32-SC	4-9	22	22	26	26	46							20	20	✓	
REZ-2S54	4-6, 4-8	No Leads - Poke in Connectors												12	12	
REZ-2T42-M3-BS	4-5	No Leads - Poke in Connectors												16	18	
REZ-2T42-M3-LD	4-5	No Leads - Poke in Connectors												20	22	
REZ-2TTS40-SC	4-6	12	12	24	24	24							20	20		
REZ-3S32-SC	4-9	22	22	26	46	26	46						20	20	✓	
RIF-1	5-2	6	(2) 6		6								24	22		
RK-2S32-TP	3-54	22	22	26	26	36							10	38	✓	
RL-2SP20-TP	5-6	15	15	15	15	18							20	50	✓	
RLCS-140-TP-W	5-7		11	11	11				10				10	21	✓	
RLQ-120-TP	5-6		18	18	12				10				20	42	✓	
RLQS-122-TP-W	5-7		13/11	11	11				13				10	22	✓	
RS-22-32-TP-W	5-7	15	15	10	10	10							10	26	✓	
RS-2S200-TP	5-3	22	22	44	44	68							4	60	✓	
RS-32-40-TP-W	5-7	10	10	10	10	10							10	26	✓	
VC-2S102-TP	5-3	18	18	43	43	19							4	47	✓	
VEZ-132-SC	4-9		22	46	26				22				20	20	✓	
VEZ-154	4-6, 4-8	No Leads - Poke in Connectors												12	12	

* Electromagnetic ballasts packed in individual cartons (IC) have shorter leads, typically 12 inches. Electronic ballasts in individual cartons (IC) have same lead lengths as listed in table.

** Also includes 36" violet & grey control leads.

Catalog Number to Page Number *Lead Lengths and Shipping Data (Fluorescent Ballasts)*

Catalog Number	See Page No.	Lead Lengths for ballasts purchased in bulk or mid-pack cartons Tolerance: +2", -1"												Shipping Data		
		Black	White	Blue	Red	Yellow	Blue/ White	Black/ White	Yellow/ Blue	Brown	Red/ White	Orange	Orange/ Black	Units Std. Ctn.	Weight Std. Ctn. (lbs.)	Avail IC* Ctn.
VEZ-1Q18-M2-BS	4-5	No Leads - Poke in Connectors												16	14	
VEZ-1T42-M2-BS	4-5	No Leads - Poke in Connectors												16	14	
VEZ-1T42-M2-LD	4-5	No Leads - Poke in Connectors												20	16	
VEZ-1T42-M2-LD-K	4-5	No Leads - Poke in Connectors												20	16	✓
VEZ-1TTS40-SC	4-6		12	24	24			12					20	20		
VEZ-2Q18-M2-BS	4-5	No Leads - Poke in Connectors												16	14	
VEZ-2Q18-M2-LD	4-5	No Leads - Poke in Connectors												20	16	
VEZ-2Q26-M2-BS	4-5	No Leads - Poke in Connectors												16	14	
VEZ-2Q26-M2-LD	4-5	No Leads - Poke in Connectors												20	16	
VEZ-2Q26-M2-LD-K	4-5	No Leads - Poke in Connectors												20	16	✓
VEZ-2S32-SC	4-9	22	22	26	26	46							20	20	✓	
VEZ-2S54	4-6, 4-8	No Leads - Poke in Connectors												12	12	
VEZ-2T42-M3-BS	4-5	No Leads - Poke in Connectors												16	18	
VEZ-2T42-M3-LD	4-5	No Leads - Poke in Connectors												20	22	
VEZ-3S32-SC	4-9	22	22	26	46	26	46						20	20	✓	
VH-1B13-TP-W	5-9		15	15				15					24	34	✓	
VH-1B9-TP-W	5-9		15	15				15					24	26		
VH-1Q26-TP-W	5-9		15	15				15					24	36	✓	
VH-2B13-TP-BLS	5-9	7	7	7									27	40		
VH-2Q26-TP-BLS	5-9	7	7	7	7								10	36		
VK-2S32-TP	3-54	22	22	26	26	36							10	38	✓	
VLO-13-TP	5-8	15		15									72	72	✓	
VLO-2S13-TP	5-8	7		7									20	26	✓	
VS-2S200-TP	5-3	22	22	44	44	68							4	60	✓	
VZT-4S32-HL**	4-15	12	12	12	15	59	15			45			6	12		

* Electromagnetic ballasts packed in individual cartons (IC) have shorter leads, typically 12 inches. Electronic ballasts in individual cartons (IC) have same lead lengths as listed in table.
 ** Also includes 36" violet & grey control leads.

Catalog Number to Page Number *HID*

Catalog Number	Page Number	Catalog Number	Page Number	Catalog Number	Page Number	Catalog Number	Page Number	Catalog Number	Page Number
7IA0280	7-35	7IA57AO	7-17	7IA7907-B	7-27	7IA86E5	7-34	74P5104-01IP	7-51
7IA0490	7-35	7IA57A0-00ID	7-8, 7-17	7IA7941	7-27	7IA86F5	7-34	74P7703-01IP	7-52
7IA0490-00ID	7-7	7IA57A2	7-18	7IA7971-00ID	7-6, 7-27	7IA8743	7-34	74P7803-01IP	7-52
7IA0590	7-36	7IA57A2-00ID	7-8, 7-18	7IA7988	7-27	7IA8743-001	7-7, 7-34	74P790301IP	7-52
7IA05FO	7-36	7IA57HO	7-17	7IA7991	7-27	7IA8753	7-34	74P8003-01IP	7-52
7IA0790	7-36	7IA5842-00IDT	7-5, 7-19	7IA79A1	7-27	7IA8753-001	7-7, 7-34	74P8013-01IP	7-52
7IA07FO	7-36	7IA5842-TAEE	7-19	7IA79A1-00ID	7-8, 7-27	7IA8793	7-34	74P8023-01IP	7-52
7IA5005-P	7-11	7IA5852-AEE	7-19	7IA79E6	7-27	7IA87A3	7-34	74P8033-01IP	7-52
7IA5037-P	7-11	7IA5892-AEE	7-19	7IA8007	7-28, 7-42	7IA87A3-001	7-38, 7-34	74P8104-01IP	7-52
7IA5037-BP	7-11	7IA5892-00ID	7-5, 7-19	7IA8007-00IDB	7-6, 7-28	7IA87J3	7-34	77L5390-00ID	7-9
7IA5081	7-11	7IA58A2	7-8, 7-19	7IA8007-B	7-28	7IA8970-00ID	7-7, 7-31	77L5492-00ID	7-9
7IA5105-P	7-11	7IA5943-TAEE	7-20	7IA8041	7-28	7IA8990	7-31	77L5570-00ID	7-9
7IA5137-BP	7-11	7IA5953-AEE	7-20	7IA8041-00ID	7-6, 7-28	7IA8991	7-31	77L5750-00ID	7-9
7IA5137-P	7-11	7IA5993-AEE	7-20	7IA8071-00ID	7-6, 7-28	7IA9741	7-44	77L6051-00ID	7-9
7IA5181-00ID	7-11	7IA6041-00ID	7-5, 7-20	7IA8088	7-28	7IA9743	7-44	77L6552-001	7-9
7IA5191	7-5, 7-11	7IA59A3	7-20	7IA8091	7-6, 7-28	7IA9749	7-44	77L8172-00ID-MOG	7-9
7IA5191-00ID	7-5, 7-11	7IA6041-00IDT	7-5, 7-20	7IA80A1	7-28	7IA9833	7-44	77L8251-00ID	7-9
7IA5205-P	7-12	7IA6042-TAEE	7-21	7IA80A1-00ID	7-8, 7-28	7IA9839	7-44	77L8453-00ID	7-9
7IA5237-BP	7-12	7IA6051-00ID	7-5, 7-20	7IA80E6	7-28	7IA9843	7-44	77L8753-001	7-9
7IA5237-P	7-12	7IA6052-AEE	7-21	7IA80H8	7-28	7IA9862	7-44	78E6091-001	7-54
7IA5280	7-12	7IA6071-00ID	7-5, 7-20	7IA80J1	7-28	7IA9900	7-44	78E6052-00IEE	7-54
7IA5292	7-5, 7-12, 7-40	7IA6091	7-20	7IA80J3	7-28	7IA9001-NP	7-45	78E6542-001	7-54
7IA5292-00ID	7-5, 7-12	7IA6092-AEE	7-21	7IA80J9	7-28	72C5181-NP	7-45	78E6592-001	7-54
7IA52A1	7-12	7IA6092-00ID	7-5, 7-21	7IA8107	7-29, 7-38, 7-42	72C5181-NP-001	7-45	78E6592-WC1	7-54
7IA52A2	7-8, 7-12, 7-40	7IA60A1	7-20	7IA8107-00IDB	7-6, 7-29	72C5280-NP-001	7-45	78E8443-001	7-53
7IA52A2-00ID	7-8, 7-12	7IA60A1-00ID	7-8, 7-20	7IA8107-B	7-29	72C5281-NP-900	7-45	78E8493-001	7-53
7IA52H2	7-12	7IA60A2	7-8, 7-21	7IA8142	7-29	72C5282-NP	7-45	79W5590-001	7-55
7IA5337-BP	7-13	7IA60E6	7-20	7IA8142-00ID	7-6, 7-29	72C5282-NP-001	7-45	79W5790-001	7-55
7IA5337-P	7-13	7IA60H1	7-20	7IA8142-T	7-29	72C5282-NP-900	7-45	79W6041-001	7-55
7IA5340-T	7-13	7IA6343-TEE	7-21	7IA8146-00ID	7-6, 7-30	72C52C2-NP	7-45	79W6091-001	7-55
7IA5383	7-13, 7-40	7IA6393-EE	7-21	7IA8148	7-30	72C5381-NP	7-45	79W6341-001	7-55
7IA5390	7-13, 7-40	7IA6452-00ID	7-5, 7-22	7IA8172-00ID	7-6, 7-29	72C5381-NP-001	7-45	79W6351-001	7-55
7IA5390-00ID	7-5, 7-13	7IA6490	7-22	7IA8176-00ID	7-6, 7-30	72C5381-NP-900	7-45	79W6542-001	7-55
7IA53AO	7-13	7IA6498	7-22	7IA8188	7-30	72C53C1-NP	7-45	79W6592-001	7-55
7IA53AO-00ID	7-8, 7-13	7IA64FO-T	7-22	7IA8192	7-29	72C5481-NP	7-45	79W8443-001	7-56
7IA5437-BP	7-14	7IA64F2-00ID	7-5, 7-22	7IA8192-00IDC	7-6	72C5482-NP	7-45	79W8493-001	7-56
7IA5442-T	7-14	7IA64F8-T	7-22	7IA8196	7-30	72C5482-NP-900	7-45	79W8743-001	7-56
7IA5490	7-14	7IA6542-001	7-5, 7-23	7IA81A2	7-29	72C54C2-NP-900	7-45	79W8793-001	7-56
7IA5492	7-14	7IA6542-T	7-23	7IA81A2-00ID	7-8, 7-29	72C5581-NP-001	7-46		
7IA5492-00ID	7-5, 7-14	7IA6552	7-23	7IA81E6	7-30	72C5582-NP	7-46		
7IA54A2	7-14	7IA6552-001	7-5, 7-23	7IA81H8	7-30	72C55C1-NP	7-46		
7IA5443-T	7-14	7IA6572-001	7-5, 7-23	7IA81J2	7-29	72C5782-NP-001	7-46		
7IA5493	7-14, 7-37	7IA6590	7-23	7IA81J3	7-30	72C5783-NP	7-46		
7IA5493-00ID	7-14, 7-37	7IA6591	7-24	7IA81J9	7-30	72C57C2-NP	7-46		
7IA54A3	7-14, 7-37, 7-38, 7-40	7IA6592	7-23	7IA8241	7-32	72C5882-NP	7-46		
7IA5540-00ID	7-5, 7-15	7IA6593	7-5, 7-24	7IA8241-00ID	7-7, 7-32	72C6082-NP-001	7-46		
7IA5543-TEE	7-15	7IA65A2	7-23	7IA8241-T	7-32	72C6182-NP	7-46		
7IA5570-00ID	7-5, 7-15	7IA65A2-001	7-8, 7-23	7IA8251	7-32	72C6182-NP-001	7-46		
7IA5590	7-15	7IA65E6-T	7-23	7IA8251-00ID	7-7, 7-32	72C7884-NP-001	7-47		
7IA5593-EE	7-5, 7-15	7IA65FO-T	7-23	7IA8271-00ID	7-7, 7-32	72C7984-NP	7-47		
7IA5593-00ID	7-5, 7-15	7IA65F1-T	7-24	7IA8291	7-32	72C7984-NP-001	7-47		
7IA55AO	7-15	7IA65F3-T	7-24	7IA8291-00IDC	7-7	72C79C4-NP	7-47		
7IA55AO-00ID	7-8, 7-15	7IA65J0	7-23	7IA82A1	7-32	72C8084-NP	7-47		
7IA55A3	7-15	7IA6742	7-25	7IA82A1-00ID	7-8, 7-32	72C8084-NP-001	7-47		
7IA55HO	7-15	7IA6742-T	7-25	7IA82E6	7-32	72C8185-NP	7-47		
7IA5642-TEE	7-16	7IA6742-001	7-5, 7-25	7IA82H1	7-32	73B5282	7-48		
7IA5692-EE	7-5, 7-16	7IA6772-001	7-5, 7-25	7IA82J1	7-32	73B5383	7-48		
7IA5692-00ID	7-5, 7-16	7IA6792	7-25	7IA82J3	7-32	73B5482	7-48		
7IA56A2	7-16	7IA67A2	7-25	7IA82J9	7-32	73B5590	7-48		
7IA5741-00ID	7-5, 7-17	7IA67A2-001	7-8, 7-25	7IA8443-00ID	7-7, 7-34	73B5591-EE	7-48		
7IA5742-TEE	7-18	7IA7707	7-26, 7-38, 7-42	7IA8443-T	7-33	73B5790	7-48		
7IA5750	7-17	7IA7707-00IDB	7-6, 7-26	7IA8453	7-33	73B5792-EE	7-48		
7IA5750-00ID	7-5, 7-17	7IA7707-B	7-26	7IA8453-00ID	7-7, 7-34	73B5892-AEE	7-48		
7IA5752-AEE	7-18	7IA7801	7-26, 7-42	7IA8473-00ID	7-7, 7-34	73B6091	7-49		
7IA5770-00ID	7-5, 7-17	7IA7801-00ID	7-6, 7-26	7IA8493	7-33	73B6092-AEE	7-49		
7IA5771-00ID	7-5, 7-17	7IA7807	7-26, 7-42	7IA8493-00IDC	7-7	73B60A1	7-49		
7IA5790	7-17	7IA7807-00IDB	7-6, 7-26	7IA84A3	7-33	73B6590	7-49		
7IA5791	7-17	7IA7807-B	7-26	7IA84A3-00ID	7-8, 7-33	73B6593	7-49		
7IA5792	7-18	7IA7891	7-26	7IA84E6	7-33	73B65A2	7-49		
7IA5792-EE	7-18	7IA7907	7-27, 7-42	7IA85E5	7-34	73B8291	7-50		
7IA5792-00ID	7-5, 7-18	7IA7907-00IDB	7-6, 7-27	7IA85F5	7-34	73B8493	7-50		

Catalog Number to Page Number

Ignitors

eHID

Catalog Number	Page Number	Catalog Number	Page Number
LI501-H4-IC	7-42, 7-43	HZTMH-210315-R-LF	6-8
LI501-J4-IC	7-40, 7-42, 7-43	ICW-140-Q-LS	6-7
LI522-H5-IC	7-40	ICW-45-Q-LS	6-7
LI523-H5-IC	7-40	ICW-60-Q-LS	6-7
LI533-H4-IC	7-40	ICW-90-Q-LS	6-7
LI533-LR	7-40	IMH-100-A-BLS-ID	6-5
LI533-LRI	7-40	IMH-100-B-LF	6-5
LI533-LR3	7-40	IMH-100-D-BLS	6-5
LI551-H4-IC	7-42	IMH-100-D-LF	6-5
LI551-J4-IC	7-42	IMH-150-H-BLS	6-5
LI561-H5-IC	7-40, 7-43	IMH-150-H-LF	6-5
LI571-H5-IC	7-40, 7-43	IMH-239-A-BLS	6-4
LI571-J5-IC	7-43	IMH-239-A-LF	6-4
LI572-H5-IC	7-40	IMH-39-A-BLS-ID	6-4
LI573-H5-IC	7-40	IMH-39-E-LF	6-4
LISOD1	7-41	IMH-39-G-BLS	6-4
LISOD1-IC	7-41	IMH-39-G-LF	6-4
		IMH-39-K-LF	6-4
		IMH-39-K-BLS	6-4
		IMH-39-K-LFS	6-4
		IMH-50-E-LF	6-5
		IMH-50-G-BLS	6-5
		IMH-50-G-LF	6-5
		IMH-50-K-BLS	6-5
		IMH-50-K-LF	6-5
		IMH-50-K-LFS	6-5
		IMH-70-A-BLS-ID	6-5
		IMH-70-D-BLS	6-5
		IMH-70-D-LF	6-5
		IMH-70-E-LF	6-5
		IMH-70-G-BLS	6-5
		IMH-70-G-LF	6-5
		IMH-G20-E-LF	6-4
		IMH-G20-G-BLS	6-4
		IMH-G20-G-LF	6-4
		IMH-G20-K-BLS	6-4
		IMH-G20-K-LF	6-4
		IMH-G20-K-LFS	6-4
		IMH-P39-G-BLS	6-4
		IMH-P39-G-LF	6-4
		IZTMH-210315-R-LF	6-8
		RMH-20-K-BLS	6-4
		RMH-20-K-LF	6-4
		RMH-20-K-LFS	6-4
		RMH-39-K-BLS	6-4
		RMH-39-K-LF	6-4
		RMH-39-K-LFS	6-4

Discontinued Catalog Number to Replacement Number *Magnetic Fluorescent*

Discontinued Catalog Number	Current Catalog Number	Page No.	Discontinued Catalog Number	Current Catalog Number	Page No.	Discontinued Catalog Number	Current Catalog Number	Page No.
038-A40	-		ASB-2432-34-BL-TP	ISB-0432-14-E	3-64	HM-1P30-TP	ICN-2S40-N	3-61
065-A40	ISB-1040-14-E	3-64	ASB-2448-46	ISB-0848-46-E	3-64	HM-2SP15	HM-2SP20-TP	5-6
217-A40	-		ASB-2448-46-BL	ISB-0848-46-E	3-64	HM-3P20	-	
268-A40	ISB-0216-12-E	3-64	ASB-2448-46-BL-TP	ISB-0848-46-E	3-64	HQM-1P40	RELB-2S40-N	3-61
276-A40	-		DIM-140-H-TP	-		HQM-2S40	RELB-2S40-N	3-61
296-A40	-		DIM-140-L-TP	-		L-120F	LC-14-20-C	5-4, 5-5
492-A40	ISB-1040-14-E	3-64	DIM-240-H-TP	-		L-132	-	
494-A40	-		DS-2S110	-		L-140-F-TP	-	
580-A40	-		DS-2S200-TP	-		L-1B13-TP-BLS	-	
752-A40	ISB-1040-14-E	3-64	DSC-110	-		L-1B13-TP-W	-	
760-A40	-		DSC-2S100	-		L-1B9-TP-BLS	-	
762-A40	-		DSC-2S110	-		L-1B9-TP-W	-	
763-A40	-		DSM-1P40	-		L-1BC13-TP-BLS	-	
826-A40	ISB-1040-14-E	3-64	DSM-2E75-S	-		L-1BC13-TP-W	-	
834-A40	-		ESEQM-240-S	-		L-1Q13-TP-W	-	
843-A40	ISB-1040-14-E	3-64	ESM-2E40-S	-		L-1Q18-TP-BLS	-	
844-A40	ISB-0432-14-E	3-64	ESM-2E75-S	-		L-1Q18-TP-W	-	
849-A40	-		G-140-TP	-		L-1Q26-TP-BLS	-	
868-A40	-		G-1S32-TP	-		L-1Q26-TP-W	H-1Q26-TP-W	5-9
902-A40	-		G-2E75-S-TP	-		L-220F	(2) LC-14-20-C	5-4, 5-5
903-A40	-		G-2S110-TP	-		LC-25	LC-25-TP	5-5, 5-8
915-A40	-		G-2S32-TP	-		LC-4-8-C	LC-4-9-C	5-4
944-A40	ISB-0432-14-E	3-64	G-2S34-TP	-		LC-4-9-C-TP	-	
957-A40	-		G-2S40-TP	-		LO-14-20-C	LC-14-20-C	5-4, 5-5
966-A40	ISB-0216-12-E	3-64	G-2S86-TP	-		LO-1Q16-TP	-	
967-A40	-		GC-140-TP	-		LO-1Q22	-	
976-A40	ISB-1040-14-E	3-64	GC-2S40-TP	-		LO-1Q28	LOS-1Q28	5-8
977-A40	-		GM-2S20-TP	-		LO-1Q28-TP	-	
A-175-S	ICN-2P60-N	3-62	GQM-2S40-TP	-		LO-4-8-C	LC-4-9-C	5-4
A-2E75-S	ICN-2P60-N	3-62	GSC-2S110-TP	-		LPL-7-9	LPL-5-9	5-4
AD-240	-		GSC-2S200	-		LQ-106F-TP	-	
ADM-251-S	-		GSM-2E75-S-TP	-		LQ-206F-TP	-	
ADM-2E40-S	-		H-140	-		LQ-2S40	RELB-2S40-N	3-61
ADM-2E75-S	ICN-2P60-N	3-62	H-1B13-TP-BLS	-		LQF-140	-	
ASB-0412-12	ISB-0216-12-E	3-64	H-1B9-TP-BLS	-		LS-113-TP	-	
ASB-0412-12-BL	ISB-0216-12-E	3-64	H-1Q16-TP	-		LSX-113-TP	-	
ASB-0412-12-BL-TP	ISB-0216-12-E	3-64	H-1Q18-TP-BLS	-		LSX-213-TP	-	
ASB-06-20-24	ISB-1040-14-E	3-64	H-1Q18-TP-W	-		LX-140-F-TP	-	
ASB-06-20-24-BL	ISB-1040-14-E	3-64	H-1Q22-TP-BLS	-		MSM-175-S	-	
ASB-0620-24-BL-TP	ISB-1040-14-E	3-64	H-1Q22-TP-W	-		MT-2S110-TP	ICN-2S110-SC	3-63
ASB-1224-24	ISB-0432-14-E	3-64	H-1Q26-TP-BLS	-		MT-2S200-TP	-	
ASB-1224-24-BL	ISB-0432-14-E	3-64	H-1Q28-TP-BLS	-		MTM-140-TP	ICN-2S40-N	3-61
ASB-1224-24-BL-TP	ISB-0432-14-E	3-64	H-1Q28-TP-W	-		MTM-2E75-S	-	
ASB-1240-46	ISB-0848-46-E	3-64	H-2B13-TP-W	-		MTM-2S40-TP	ICN-2S40-N	3-61
ASB-1240-46-BL	ISB-0848-46-E	3-64	H-2B9-TP-BLS	-		R-140-TP	RELB-2S40-N	3-61
ASB-1240-46-BL-TP	ISB-0848-46-E	3-64	H-2B9-TP-W	-		R-1BP27-TP	-	
ASB-2040-24	ISB-1040-14-E	3-64	H-2Q18-TP-BLS	-		R-1BP39-TP	-	
ASB-2040-24-BL	ISB-1040-14-E	3-64	H-2Q18-TP-W	-		R-1BP40-TP	-	
ASB-2040-24-BL-TP	ISB-1040-14-E	3-64	H-2Q26-TP-W	-		R-1P32-TP	ICN-1P32-N	3-39, 3-43, 3-47, 3-50, 3-53
			HD-140	-		R-1P817-TP	ICN-1P32-N	3-39, 3-43, 3-47, 3-50, 3-53
			HM-140-TP	RELB-2S40-N	3-61			

Discontinued Catalog Number to Replacement Number

Magnetic Fluorescent

Discontinued Catalog Number	Current Catalog Number	Page No.
R-1P825-TP	ICN-1P32-N	3-39, 3-43, 3-47, 3-50, 3-53
R-1P840-TP	ICN-1P32-N	3-39, 3-43, 3-47, 3-50, 3-53
R-1S32-TP	ICN-1P32-N	3-39, 3-43, 3-47, 3-50, 3-53
R-1U40-TP	RELB-2S40-N	3-61
R-22-32-TP	RS-22-32-TP-W	5-7
R-2BP27-TP	-	
R-2BS39-TP	-	
R-2BS40-TP	-	
R-2E60-S-TP	ICN-2P60-N	3-62
R-2E75-S-TP	ICN-2P60-N	3-62
R-2E75-S-TP-AC	ICN-2P60-N	3-62
R-2E75-S-TP-MC	ICN-2P60-N	3-62
R-2P32-TP	ICN-2P32-N	3-39, 3-40, 3-43, 3-44, 3-47, 3-48, 3-50, 3-51, 3-53, 3-54
R-2P817-TP	ICN-2P32-N	3-39, 3-40, 3-43, 3-44, 3-47, 3-48, 3-50, 3-51, 3-53, 3-54
R-2P825-TP	ICN-2P32-N	3-39, 3-40, 3-43, 3-44, 3-47, 3-48, 3-50, 3-51, 3-53, 3-54
R-2P840-TP	ICN-2P32-N	3-39, 3-40, 3-43, 3-44, 3-47, 3-48, 3-50, 3-51, 3-53, 3-54
R-2Q18-4P-TP-BLS	-	
R-2Q18-4P-TP-W	-	
R-2Q26-4P-TP-BLS	-	
R-2Q26-4P-TP-W	-	
R-2S110-TP	ICN-2S110-SC	3-63
R-2S32-TP	ICN-2P32-N	3-39, 3-40, 3-43, 3-44, 3-47, 3-48, 3-50, 3-51, 3-53, 3-54
R-2S34-TP	RELB-2S40-N	3-61
R-2S40-TP	RELB-2S40-N	3-61
R-2S40-TP-AC	RELB-2S40-N	3-61
R-2S40-TP-MC	RELB-2S40-N	3-61
R-2S65-TP	ICN-2S86-SC	3-60
R-2S86-TP	ICN-2S86-SC	3-60
R-2SP30-TP	RELB-2S40-N	3-61
R-32-40-TP	RS-32-40-TP-W	5-7
R-3S34-TP	-	
R-4S40-A-TP-AC	(2) RELB-2S40-N	3-61
RC-140-TP	-	
RC-160-(FO or RO)	-	
RC-160-TP	ICN-2S110-SC	3-63
RC-180	-	
RC-1P40-TP	-	
RC-2E75-S-TP	-	
RC-2S102-FO	-	
RC-2S102-RO	-	

Discontinued Catalog Number	Current Catalog Number	Page No.
RC-2S110	ICN-2S110-SC	3-63
RC-2S110-FO	-	
RC-2S110-RO	-	
RC-2S200-(FO or RO)	-	
RC-2S40-TP	-	
RC-2S85-FO	-	
RC-2S85-RO	-	
RC-2S85-TP	-	
RC-2SP40-TP	-	
RC-2SP830-TP	-	
RC-3S150-TP	-	
RC-3S200-TP	-	
RC-4S155	-	
RC-4S60-TP	ISB-0432-14-E	3-64
RC-4S85-TP	ISB-0432-14-E	3-64
RH-2S200	RS-2S200-TP	5-3
RL-140-TP	-	
RL-3SP20-TP	-	
RLC-140	-	
RLCS-140	RLCS-140-TP-W	5-7
RLM-2SP20	RL-2SP20-TP	5-6
RLQ-122-TP	RLQS-122-TP-W	5-7
RLQC-1100-CW	-	
RLQC-140	-	
RLQCS-140	RLCS-140-TP-W	5-7
RM-140-TP	RELB-2S40-N	3-61
RM-2S35-TP	-	
RM-2S40-TP	RELB-2S40-N	3-61
RM-2SP30-TP	RELB-2S40-N	3-61
RMS-22-32-TP-W	RS-22-32-TP-W	5-7
RMS-32-40-TP-W	RS-32-40-TP-W	5-7
RQB-2S102	RC-2S102-TP	5-3
RQC-102-(FO or RO)	-	
RQC-102-CW	RC-2S102-TP	5-3
RQC-1100-CW	-	
RQC-2S100-CW	-	
RQC-2S102-(FO or RO)	-	
RQC-2S102-CW	RC-2S102-TP	5-3
RQC-3S60-CW	ISB-0432-14-E	3-64
RQC-3S85-CW	ISB-0432-14-E	3-64
RQM-2S40-TP	RELB-2S40-N	3-61
RS-110-(FO or RO)	-	
RS-110-TP	ICN-2S110-SC	3-63
RS-160-TP	ICN-2S110-SC	3-63
RS-2S100-TP	-	
RS-2S110-(FO or RO)	-	
RS-2S110-TP	ICN-2S110-SC	3-63
RS-2S200-FO	-	
RS-2S40-TP	RELB-2S40-N	3-61
RS-2S60-TP	-	

Discontinued Catalog Number	Current Catalog Number	Page No.
RS-2S80	-	
RS-2S85	-	
RS-2S85-(FO or RO)	-	
RS-3P40-TP	-	
RSC-2S155-TP	RC-2S200-TP	5-3
RSC-4S60	ISB-0432-14-E	3-64
RSD-140	-	
RSH-115	HM-1P20-TP	5-6
RSH-120	HM-1P20-TP	5-6
RSH-180	-	
RSH-1D40	-	
RSH-215	HM-2SP20-TP	5-6
RSH-220	HM-2SP20-TP	5-6
RSH-225-F	-	
RSH-248-S	-	
RSH-2E75-S	ICN-2P60-N	3-62
RSHM-130	-	
RSHM-140-TP	RELB-2S40-N	3-61
RSHM-175-S	ICN-2P60-N	3-62
RSHM-230-TP	-	
RSHM-240-TP	RELB-2S40-N	3-61
RSL-104	-	
RSL-118-G	-	
RSL-122	LC-14-20-C	5-4, 5-5
RSL-125	LC-25-TP	5-5, 5-8
RSL-131-G	-	
RSL-150	-	
RSL-180	-	
RSL-2232	-	
RSL-225	-	
RSM-175-S-TP	ICN-2P60-N	3-62
S-240	RELB-2S40-N	3-61
S-251-S-TP	-	
S-269-S	-	
S-275-S-TP	ICN-2P60-N	3-62
S-285-TP	-	
SI-240-S-TP	-	
SM-116-G	-	
SM-125-S-TP	-	
SM-140-S-TP	-	
SM-148-S	-	
SM-151-S-TP	-	
SM-225-S-TP	-	
SM-233-S	-	
SM-2E40-S-TP	-	
SM-2E51-S-TP	-	
SM-2E57-S-TP	ICN-2P60-N	3-62
SM-2E75-S-TP	ICN-2P60-N	3-62
TM-2E75-S-TP	-	
TM-2S40-TP	-	
UHQM-1P40	ICN-2S40-N	3-61

Discontinued Catalog Number to Replacement Number *Magnetic Fluorescent*

Discontinued Catalog Number	Current Catalog Number	Page No.	Discontinued Catalog Number	Current Catalog Number	Page No.	Discontinued Catalog Number	Current Catalog Number	Page No.
UM-140	ICN-2540-N	3-61	V-2540-TP	ICN-2540-N	3-61	VS-110-(FO or RO)	-	
UM-1P30	-		V-2586-TP	ICN-2586-SC	3-60	VS-110-TP	ICN-25110-SC	3-63
UM-2540	ICN-2540-N	3-61	V-25P30-TP	ICN-2540-N	3-61	VS-140-TP	ICN-2540-N	3-61
UM-25P30	-		V-3534-TP	-		VS-160-TP	ICN-25110-SC	3-63
UQC-25102	VC-25102-TP	5-3	VADM-2E75-S	ICN-2P60-N	3-62	VS-25110-(FO or RO)	-	
UQC-25102-CW	VC-25102-TP	5-3	VC-160-(FO or RO)	-		VS-25110-TP	ICN-25110-SC	3-63
UQM-2540	ICN-2540-N	3-61	VC-160-TP	ICN-25110-SC	3-63	VS-25200-FO	-	
UQM-25P20	-		VC-1P40-TP	-		VS-25200-RO	-	
US-110-TP	ICN-25110-SC	3-63	VC-2E75-S-TP	-		VS-2540-TP	ICN-2540-N	3-61
US-140	ICN-2540-N	3-61	VC-25102-FO	-		VS-2560-TP	-	
US-25110	ICN-25110-SC	3-63	VC-25102-RO	-		VS-2585	-	
US-2560	-		VC-25110-FO	-		VS-2585-(FO or RO)	-	
US-3P40	-		VC-25200-RO	-		VS-3P40	-	
USC-25200	VS-25200-TP	5-3	VC-25200-TP	-		VS-0412-12-BL-TP	-	
USH-110	ICN-25110-SC	3-63	VC-2585-TP	-		VS-0412-12-BL-TP	ISB-0216-12-E	3-64
USM-175-S	ICN-2P60-N	3-62	VC-25P40-TP	-		VS-0620-24-BL-TP	ISB-1040-14-E	3-64
USM-2E40-S	-		VH-1B13-TP-BLS	-		VS-1224-24-BL-TP	ISB-0432-14-E	3-64
USM-2E75-S	ICN-2P60-N	3-62	VH-1B9-TP-BLS	-		VS-1240-46-BL-TP	ISB-0848-46-E	3-64
V-140-TP	ICN-2540-N	3-61	VH-1Q18-TP-BLS	-		VS-2040-24-BL-TP	ISB-1040-14-E	3-64
V-1BP27-TP	-		VH-1Q18-TP-W	-		VS-2448-46-BL-TP	ISB-0848-46-E	3-64
V-1BP39-TP	-		VH-1Q26-TP-BLS	-		VSH-240	-	
V-1BP40-TP	-		VH-2B13-TP-W	-		VSH-240-S	-	
V-1P32-TP	ICN-1P32-N	3-39, 3-43, 3-47, 3-50, 3-53	VH-2B9-TP-BLS	-		VSH-275-S-TP	ICN-2P60-N	3-62
V-1P817-TP	ICN-1P32-N	3-39, 3-43, 3-47, 3-50, 3-53	VH-2B9-TP-W	-		VSH-285	-	
V-1P825-TP	ICN-1P32-N	3-39, 3-43, 3-47, 3-50, 3-53	VH-2Q18-TP-BLS	-		VSH-2E75-S	ICN-2P60-N	3-62
V-1P840-TP	ICN-1P32-N	3-39, 3-43, 3-47, 3-50, 3-53	VH-2Q18-TP-W	-		VSHM-125-S	-	
V-1U40-TP	ICN-2540-N	3-61	VH-2Q26-TP-W	-		VSHM-140	ICN-2540-N	3-61
V-2BP27-TP	-		VH-2Q26-TP-W	-		VSL-108-F-TP	-	
V-2B539-TP	-		VHQM-1P40	ICN-2540-N	3-61	VSM-140-S	-	
V-2B540-TP	-		VL-1B13-TP-BLS	-		VSM-175-S-TP	ICN-2P60-N	3-62
V-2E60-S-TP	ICN-2P60-N	3-62	VL-1B13-TP-W	-		VSM-225-S	-	
V-2E75-S-TP	ICN-2P60-N	3-62	VL-1B9-TP-BLS	-		VSM-2E40-S-TP	-	
V-2P32-TP	ICN-2P32-N	3-39, 3-40, 3-43, 3-44, 3-47, 3-48, 3-50, 3-51, 3-53, 3-54	VL-1B9-TP-W	-		VSM-2E75-S-TP	ICN-2P60-N	3-62
V-2P817-TP	ICN-2P32-N	3-39, 3-40, 3-43, 3-44, 3-47, 3-48, 3-50, 3-51, 3-53, 3-54	VL-1Q18-TP-BLS	-		X-140-TP	ICN-2540-N	3-61
V-2P825-TP	ICN-2P32-N	3-39, 3-40, 3-43, 3-44, 3-47, 3-48, 3-50, 3-51, 3-53, 3-54	VL-1Q18-TP-W	-		XHM-1P20-TP	-	
V-2P840-TP	ICN-2P32-N	3-39, 3-40, 3-43, 3-44, 3-47, 3-48, 3-50, 3-51, 3-53, 3-54	VL-1Q26-TP-BLS	-		XHQM-1P40-TP	ICN-2540-N	3-61
V-2Q18-4P-TP-BLS	-		VL-1Q26-TP-W	-		XM-25P20-TP	-	
V-2Q18-4P-TP-W	-		VLQ-106F-TP	-		XQM-2540-TP	ICN-2540-N	3-61
V-2Q26-4P-TP-BLS	-		VM-140-TP	ICN-2540-N	3-61	XT-2E57-S-TP	-	
V-2Q26-4P-TP-W	-		VM-1P30-TP	ICN-2540-N	3-61	YHQM-1P40-TP	ICN-2540-N	3-61
V-25110-TP	ICN-25110-SC	3-63	VM-2540-TP	ICN-2540-N	3-61	YQC-25102-TP	-	
V-2534-TP	ICN-2540-N	3-61	VM-25PI5	-		YQM-2540-TP	ICN-2540-N	3-61
			VM-25P20-TP	-		YS-25110-TP	ICN-25110-SC	3-63
			VM-25P30-TP	ICN-2540-N	3-61	YS-2585-TP	-	
			VQB-25102	VC-25102-TP	5-3	YSC-25200-TP	-	
			VQC-1100-CW	-		YSM-2E75-S-TP	ICN-2P60-N	3-62
			VQC-25100-CW	-				
			VQC-25102-(FO or RO)	-				
			VQC-25102-CW	VC-25102-TP	5-3			
			VQM-2540-TP	ICN-2540-N	3-61			

Discontinued Catalog Number to Replacement Number *Electronic Fluorescent*

Discontinued Catalog Number	Current Catalog Number	Page No.
GCN-1P32-SC	GOPA-1P32-SC	3-39, 3-43, 3-47, 3-50, 3-53
GCN-1S32	-	
GCN-2P32	GOPA-2P32-SC	3-39, 3-40, 3-43, 3-44, 3-47, 3-48, 3-50, 3-51, 3-53, 3-54, 3-57
GCN-2P32-SC	GOPA-2P32-SC	3-39, 3-40, 3-43, 3-44, 3-47, 3-48, 3-50, 3-51, 3-53, 3-54, 3-57
GCN-2P60-S-A	-	
GCN-2S32	GOP-2PSP32-SC	3-39, 3-40, 3-43, 3-44, 3-47, 3-48, 3-50, 3-51, 3-53, 3-54
GCN-3P32-SC	GOPA-3P32-SC	3-40, 3-41, 3-44, 3-45, 3-48, 3-49, 3-51, 3-52, 3-54, 3-55, 3-57
GCN-3S32	GOP-2PSP32-SC	3-39, 3-40, 3-43, 3-44, 3-47, 3-48, 3-50, 3-51, 3-53, 3-54
GCN-4P32-SC	GOPA-4P32-SC	3-41, 3-42, 3-45, 3-46, 3-49, 3-52, 3-55, 3-56, 3-58
GEL-1P32-SC	GOPA-1P32-SC	3-39, 3-43, 3-47, 3-50, 3-53
GEL-2P32-LW-RH-TP	GOPA-2P32-LW-SC	3-39, 3-40, 3-43, 3-44, 3-47, 3-48, 3-50, 3-51, 3-53, 3-54, 3-57
GEL-2P32-SC	GOPA-2P32-SC	3-39, 3-40, 3-43, 3-44, 3-47, 3-48, 3-50, 3-51, 3-53, 3-54, 3-57
GEL-2P59	-	
GEL-2S32-RH-TP	GOP-2PSP32-SC	3-39, 3-40, 3-43, 3-44, 3-47, 3-48, 3-50, 3-51, 3-53, 3-54
GEL-2S40-RH-TP	-	
GEL-3P32-RH-TP	GOPA-3P32-SC	3-40, 3-41, 3-44, 3-45, 3-48, 3-49, 3-51, 3-52, 3-54, 3-55, 3-57
GEL-3P32-SC	GOPA-3P32-SC	3-40, 3-41, 3-44, 3-45, 3-48, 3-49, 3-51, 3-52, 3-54, 3-55, 3-57
GEL-4P32-LW	GOPA-4P32-LW-SC	3-41, 3-42, 3-45, 3-46, 3-49, 3-52, 3-55, 3-56, 3-58
GEL-4P32-RH-TP	GOPA-4P32-SC	3-41, 3-42, 3-45, 3-46, 3-49, 3-52, 3-55, 3-56, 3-58
GEL-4P32-SC	GOPA-4P32-SC	3-41, 3-42, 3-45, 3-46, 3-49, 3-52, 3-55, 3-56, 3-58
GIC-132-TP	-	
GIC-140-TP	-	
GIC-2S32-TP	GOP-2PSP32-SC	3-39, 3-40, 3-43, 3-44, 3-47, 3-48, 3-50, 3-51, 3-53, 3-54
GIC-3S32-TP	GOP-2PSP32-SC	3-39, 3-40, 3-43, 3-44, 3-47, 3-48, 3-50, 3-51, 3-53, 3-54
ICF-1H120-M4-LD	-	
ICF-2S70-M4-LD	-	
ICN-1P32-LW-SC	IOPA-1P32-LW-N	3-39, 3-43, 3-47, 3-50, 3-53
ICN-1P32-SC	ICN-1P32-N	3-39, 3-43, 3-47, 3-50, 3-53
ICN-1S80	ICN-1S80-T	3-29, 3-35, 3-68
ICN-2P32-LW-SC	IOPA-2P32-LW-N	3-39, 3-40, 3-43, 3-44, 3-47, 3-48, 3-50, 3-51, 3-53, 3-54, 3-57

Discontinued Catalog Number	Current Catalog Number	Page No.
ICN-2P32-SC	ICN-2P32-N	3-39, 3-40, 3-43, 3-44, 3-47, 3-48, 3-50, 3-51, 3-53, 3-54, 3-57
ICN-2P60-SC	ICN-2P60-N	3-62
ICN-2S24	ICN-2S24-T	3-27, 3-32, 3-33
ICN-2S28	ICN-2S28-T	3-30, 3-31
ICN-2S39	ICN-2S39-T	3-27, 3-32, 3-33
ICN-2S54	ICN-2S54-T	3-27 to 29, 3-32 to 35, 3-68
ICN-2S54-90C	ICN-2S54-90C-T	3-27 to 29, 3-32 to 35, 3-68
ICN-2S54-90C-SC	ICN-2S54-90C-N	3-27 to 29, 3-32 to 35, 3-68
ICN-2S86	ICN-2S86-SC	3-60
ICN-3P32-LW-SC	IOPA-3P32-LW-N	3-40, 3-41, 3-44, 3-45, 3-48, 3-49, 3-51, 3-52, 3-54, 3-55, 3-57
ICN-3P32-SC	ICN-3P32-N	3-40, 3-41, 3-44, 3-45, 3-48, 3-49, 3-51, 3-52, 3-54, 3-55, 3-57
ICN-3S14-D	ICN-3S14-T	3-30
ICN-4P32-LW-SC	IOPA-4P32-LW-N	3-41, 3-42, 3-45, 3-46, 3-49, 3-52, 3-55, 3-56, 3-58
ICN-4P32-SC	ICN-4P32-N	3-41, 3-42, 3-45, 3-46, 3-49, 3-52, 3-55, 3-56, 3-58
IIC-132-SC	IOP-1PSP32-N	3-39, 3-43, 3-47, 3-50, 3-53
IIC-2S32-SC	IOP-2PSP32-N	3-39, 3-40, 3-43, 3-44, 3-47, 3-48, 3-50, 3-51, 3-53, 3-54
IIC-3S32-SC	IOP-3PSP32-SC	3-40, 3-41, 3-44, 3-45, 3-48, 3-49, 3-51, 3-52, 3-54, 3-55
IOP-1P32-HL-SC	IOP-1P32-HL-N	3-39, 3-43, 3-47, 3-50, 3-53
IOP-1P32-LW-SC	IOP-1P32-LW-N	3-39, 3-43, 3-47, 3-50, 3-53
IOP-1P32-SC	IOP-1P32-N	3-39, 3-43, 3-47, 3-50, 3-53
IOP-1S32-LW-SC	IOP-1PSP32-LW-N	3-39, 3-43, 3-47, 3-50, 3-53
IOP-1S32-SC	IOP-1PSP32-N	3-39, 3-43, 3-47, 3-50, 3-53
IOP-2P32-HL-SC	IOP-2P32-HL-N	3-39, 3-40, 3-43, 3-44, 3-47, 3-48, 3-50, 3-51, 3-53, 3-54, 3-57
IOP-2P32-LW-SC	IOP-2P32-LW-N	3-39, 3-40, 3-43, 3-44, 3-47, 3-48, 3-50, 3-51, 3-53, 3-54, 3-57
IOP-2P32-SC	IOP-2P32-N	3-39, 3-40, 3-43, 3-44, 3-47, 3-48, 3-50, 3-51, 3-53, 3-54, 3-57
IOP-2P59-SC	IOP-2P59-N	3-59
IOP-2S32-LW-SC	IOP-2PSP32-LW-N	3-39, 3-40, 3-43, 3-44, 3-47, 3-48, 3-50, 3-51, 3-53, 3-54
IOP-2S32-SC	IOP-2PSP32-N	3-39, 3-40, 3-43, 3-44, 3-47, 3-48, 3-50, 3-51, 3-53, 3-54
IOP-3P32-HL-SC	IOP-3P32-HL-N	3-40, 3-41, 3-44, 3-45, 3-48, 3-49, 3-51, 3-52, 3-54, 3-55, 3-57
IOP-3P32-LW-SC	IOP-3P32-LW-N	3-40, 3-41, 3-44, 3-45, 3-48, 3-49, 3-51, 3-52, 3-54, 3-55, 3-57
IOP-3P32-SC	IOP-3P32-N	3-40, 3-41, 3-44, 3-45, 3-48, 3-49, 3-51, 3-52, 3-54, 3-55, 3-57

Discontinued Catalog Number	Current Catalog Number	Page No.
IOP-3S32-LW-SC	IOP-3PSP32-LW-SC	3-40, 3-41, 3-44, 3-45, 3-48, 3-49, 3-51, 3-52, 3-54, 3-55
IOP-3S32-SC	IOP-3PSP32-SC	3-40, 3-41, 3-44, 3-45, 3-48, 3-49, 3-51, 3-52, 3-54, 3-55
IOP-4P32-LW-SC	IOP-4P32-LW-N	3-41, 3-42, 3-45, 3-46, 3-49, 3-52, 3-55, 3-56, 3-58
IOP-4P32-SC	IOP-4P32-N	3-41, 3-42, 3-45, 3-46, 3-49, 3-52, 3-55, 3-56, 3-58
IOP-4S32-LW-SC	IOP-4PSP32-LW-SC	3-41, 3-42, 3-45, 3-46, 3-49, 3-52, 3-55, 3-56
IOP-4S32-SC	IOP-4PSP32-SC	3-41, 3-42, 3-45, 3-46, 3-49, 3-52, 3-55, 3-56
IOPA-1P32-HL-SC	IOPA-1P32-HL-N	3-39, 3-43, 3-47, 3-50, 3-53
IOPA-1P32-LW-SC	IOPA-1P32-LW-N	3-39, 3-43, 3-47, 3-50, 3-53
IOPA-1P32-SC	IOPA-1P32-N	3-39, 3-43, 3-47, 3-50, 3-53
IOPA-2P32-HL-SC	IOPA-2P32-HL-N	3-39, 3-40, 3-43, 3-44, 3-47, 3-48, 3-50, 3-51, 3-53, 3-54, 3-57
IOPA-2P32-LW-SC	IOPA-2P32-LW-N	3-39, 3-40, 3-43, 3-44, 3-47, 3-48, 3-50, 3-51, 3-53, 3-54, 3-57
IOPA-2P32-SC	IOPA-2P32-N	3-39, 3-40, 3-43, 3-44, 3-47, 3-48, 3-50, 3-51, 3-53, 3-54, 3-57
IOPA-3P32-HL-90C-SC	IOP-3P32-HL-90C-N	3-40, 3-41, 3-44, 3-45, 3-48, 3-49, 3-51, 3-52, 3-54, 3-55, 3-57
IOPA-3P32-LW-SC	IOPA-3P32-LW-N	3-40, 3-41, 3-44, 3-45, 3-48, 3-49, 3-51, 3-52, 3-54, 3-55, 3-57
IOPA-3P32-SC	IOPA-3P32-N	3-40, 3-41, 3-44, 3-45, 3-48, 3-49, 3-51, 3-52, 3-54, 3-55, 3-57
IOPA-4P32-HL-90C-G	IOP-4P32-HL-90C-SC	3-41, 3-42, 3-45, 3-46, 3-49, 3-52, 3-55, 3-56, 3-58
IOPA-4P32-HL-SC	IOP-4P32-HL-SC	3-41, 3-42, 3-45, 3-46, 3-49, 3-52, 3-55, 3-56, 3-58
IOPA-4P32-LW-SC	IOPA-4P32-LW-N	3-41, 3-42, 3-45, 3-46, 3-49, 3-52, 3-55, 3-56, 3-58
IOPA-4P32-SC	IOPA-4P32-N	3-41, 3-42, 3-45, 3-46, 3-49, 3-52, 3-55, 3-56, 3-58
JOP-2S84-G	-	
JOP-2S95-G	-	
RCF-2S13-HI-LD-QS	-	
RCF-2S18-HI-LD-QS	-	
RCN-132-MC	ICN-132-MC	3-39, 3-43, 3-53
RCN-1P32	ICN-1P32-N	3-39, 3-43, 3-47, 3-50, 3-53
RCN-1P32-SC	ICN-1P32-N	3-39, 3-43, 3-47, 3-50, 3-53
RCN-1S28	ICN-2S28-T	3-30, 3-31
RCN-1S32-SC	IOP-1PSP32-N	3-39, 3-43, 3-47, 3-50, 3-53
RCN-1S40-SC	RELB-2S40-N	3-61
RCN-ITTP40-SC	ICN-ITTP40-SC	3-28
RCN-2M32-MC	ICN-2M32-MC	3-40, 3-44, 3-54

Discontinued Catalog Number to Replacement Number *Electronic Fluorescent*

Discontinued Catalog Number	Current Catalog Number	Page No.	Discontinued Catalog Number	Current Catalog Number	Page No.	Discontinued Catalog Number	Current Catalog Number	Page No.
RCN-2P32	ICN-2P32-N	3-39, 3-40, 3-43, 3-44, 3-47, 3-48, 3-50, 3-51, 3-53, 3-54, 3-57	REL-1S32-RH-TP	IOP-1PSP32-N	3-39, 3-43, 3-47, 3-50, 3-53	REL-3P32-RH-TP	ICN-3P32-N	3-40, 3-41, 3-44, 3-45, 3-48, 3-49, 3-51, 3-52, 3-54, 3-55, 3-57
RCN-2P32-LW	IOPA-2P32-LW-N	3-39, 3-40, 3-43, 3-44, 3-47, 3-48, 3-50, 3-51, 3-53, 3-54, 3-57	REL-1S40-RH-TP	RELB-2S40-N	3-61	REL-3P32-SC	ICN-3P32-N	3-40, 3-41, 3-44, 3-45, 3-48, 3-49, 3-51, 3-52, 3-54, 3-55, 3-57
RCN-2P32-SC	ICN-2P32-N	3-39, 3-40, 3-43, 3-44, 3-47, 3-48, 3-50, 3-51, 3-53, 3-54, 3-57	REL-1S40-SC	RELB-2S40-N	3-61	REL-3P32-TP	ICN-3P32-N	3-40, 3-41, 3-44, 3-45, 3-48, 3-49, 3-51, 3-52, 3-54, 3-55, 3-57
RCN-2P54-SC	ICN-2S54-N	3-27 to 29, 3-32 to 35, 3-68	REL-1S40-TP	RELB-2S40-N	3-61	REL-3S32-LW-RH-TP	IOP-3PSP32-LW-SC	3-40, 3-41, 3-44, 3-45, 3-48, 3-49, 3-51, 3-52, 3-54, 3-55
RCN-2P59	IOP-2P59-N	3-59	REL-1T32	ICF-2S18-HI-LD	3-22, 3-23, 3-25	REL-3S32-RH-TP	IOP-3PSP32-SC	3-40, 3-41, 3-44, 3-45, 3-48, 3-49, 3-51, 3-52, 3-54, 3-55
RCN-2S28	ICN-2S28-T	3-30, 3-31	REL-1T42	ICF-2S18-HI-LD	3-22, 3-23, 3-25	REL-3S40-RH-TP	-	-
RCN-2S32-LW	IOP-2PSP32-LW-N	3-39, 3-40, 3-43, 3-44, 3-47, 3-48, 3-50, 3-51, 3-53, 3-54	REL-2P17-RH-TP	ICN-2P32-N	3-39, 3-40, 3-43, 3-44, 3-47, 3-48, 3-50, 3-51, 3-53, 3-54, 3-57	REL-3S40-TP	-	-
RCN-2S32-SC	IOP-2PSP32-N	3-39, 3-40, 3-43, 3-44, 3-47, 3-48, 3-50, 3-51, 3-53, 3-54	REL-2P30-G	-	-	REL-4P32-2LS	-	-
RCN-2S40	ICN-2S40-N	3-61	REL-2P32-HL-RH-TP	IOPA-2P32-HL-N	3-39, 3-40, 3-43, 3-44, 3-47, 3-48, 3-50, 3-51, 3-53, 3-54, 3-57	REL-4P32-LW-RH-TP	IOPA-4P32-LW-N	3-41, 3-42, 3-45, 3-46, 3-49, 3-52, 3-55, 3-56, 3-58
RCN-2S40-SC	ICN-2S40-N	3-61	REL-2P32-HL-SC	IOPA-2P32-HL-N	3-39, 3-40, 3-43, 3-44, 3-47, 3-48, 3-50, 3-51, 3-53, 3-54, 3-57	REL-4P32-LW-SC	IOPA-4P32-LW-N	3-41, 3-42, 3-45, 3-46, 3-49, 3-52, 3-55, 3-56, 3-58
RCN-2S86	ICN-2S86-SC	3-60	REL-2P32-LW-RH-TP	IOPA-2P32-LW-N	3-39, 3-40, 3-43, 3-44, 3-47, 3-48, 3-50, 3-51, 3-53, 3-54, 3-57	REL-4P32-RH-TP	ICN-4P32-N	3-41, 3-42, 3-45, 3-46, 3-49, 3-52, 3-55, 3-56, 3-58
RCN-2TTP40-SC	ICN-2TTP40-SC	3-28	REL-2P32-LW-SC	IOPA-2P32-LW-N	3-39, 3-40, 3-43, 3-44, 3-47, 3-48, 3-50, 3-51, 3-53, 3-54, 3-57	REL-4P32-SC	ICN-4P32-N	3-41, 3-42, 3-45, 3-46, 3-49, 3-52, 3-55, 3-56, 3-58
RCN-3P32	ICN-3P32-N	3-40, 3-41, 3-44, 3-45, 3-48, 3-49, 3-51, 3-52, 3-54, 3-55, 3-57	REL-2P32-RH-TP	ICN-2P32-N	3-39, 3-40, 3-43, 3-44, 3-47, 3-48, 3-50, 3-51, 3-53, 3-54, 3-57	REL-4P32-TP	ICN-4P32-N	3-41, 3-42, 3-45, 3-46, 3-49, 3-52, 3-55, 3-56, 3-58
RCN-3P32-LW-SC	IOPA-3P32-LW-N	3-40, 3-41, 3-44, 3-45, 3-48, 3-49, 3-51, 3-52, 3-54, 3-55, 3-57	REL-2P32-SC	ICN-2P32-N	3-39, 3-40, 3-43, 3-44, 3-47, 3-48, 3-50, 3-51, 3-53, 3-54, 3-57	RELB-1S40-SC	RELB-2S40-N	3-61
RCN-3P32-SC	ICN-3P32-N	3-40, 3-41, 3-44, 3-45, 3-48, 3-49, 3-51, 3-52, 3-54, 3-55, 3-57	REL-2P50-SC	-	-	RELB-2S40-SC	RELB-2S40-N	3-61
RCN-3S32-SC	IOP-3PSP32-SC	3-40, 3-41, 3-44, 3-45, 3-48, 3-49, 3-51, 3-52, 3-54, 3-55	REL-2P59-HL	-	-	RIC-132	IOP-1PSP32-N	3-39, 3-43, 3-47, 3-50, 3-53
RCN-3TTP40-SC	ICN-3TTP40-SC	3-28	REL-2P59-S	IOP-2P59-N	3-59	RIC-132-TP	IOP-1PSP32-N	3-39, 3-43, 3-47, 3-50, 3-53
RCN-4P32	ICN-4P32-N	3-41, 3-42, 3-45, 3-46, 3-49, 3-52, 3-55, 3-56, 3-58	REL-2P60-S	IOP-2P59-N	3-59	RIC-140-TP	ICN-2S40-N	3-61
RCN-4P32-LW-SC	IOPA-4P32-LW-N	3-41, 3-42, 3-45, 3-46, 3-49, 3-52, 3-55, 3-56, 3-58	REL-2P60-S-A	IOP-2P59-N	3-59	RIC-2S32	IOP-2PSP32-N	3-39, 3-40, 3-43, 3-44, 3-47, 3-48, 3-50, 3-51, 3-53, 3-54
RCN-4P32-SC	ICN-4P32-N	3-41, 3-42, 3-45, 3-46, 3-49, 3-52, 3-55, 3-56, 3-58	REL-2P64-IS	-	-	RIC-2S32-TP	IOP-2PSP32-N	3-39, 3-40, 3-43, 3-44, 3-47, 3-48, 3-50, 3-51, 3-53, 3-54
RCN-4S32-SC	IOP-4PSP32-SC	3-41, 3-42, 3-45, 3-46, 3-49, 3-52, 3-55, 3-56	REL-2P75-S-RH-TP	ICN-2P60-N	3-62	RIC-2S40-TP	ICN-2S40-N	3-61
REB-113-M6-BLS	-	-	REL-2P75-S-TP	ICN-2P60-N	3-62	RIC-3S32	IOP-3PSP32-SC	3-40, 3-41, 3-44, 3-45, 3-48, 3-49, 3-51, 3-52, 3-54, 3-55
REB-113-M6-EL	-	-	REL-2Q18	ICF-2S18-HI-LD	3-22, 3-23, 3-25	RIC-3S32-TP	IOP-3PSP32-SC	3-40, 3-41, 3-44, 3-45, 3-48, 3-49, 3-51, 3-52, 3-54, 3-55
REB-118-M6-BLS	-	-	REL-2Q26	ICF-2S18-HI-LD	3-22, 3-23, 3-25	ROP-2P32-LW-SC	IOP-2P32-LW-N	3-39, 3-40, 3-43, 3-44, 3-47, 3-48, 3-50, 3-51, 3-53, 3-54, 3-57
REB-118-M6-EL	-	-	REL-2S110	ICN-2S110-SC	3-63	ROP-2P32-SC	IOP-2P32-N	3-39, 3-40, 3-43, 3-44, 3-47, 3-48, 3-50, 3-51, 3-53, 3-54, 3-57
REB-126-M6-BLS	-	-	REL-2S32-LW-RH-TP	IOP-2PSP32-LW-N	3-39, 3-40, 3-43, 3-44, 3-47, 3-48, 3-50, 3-51, 3-53, 3-54	ROP-3P32-LW-SC	IOP-3P32-LW-N	3-40, 3-41, 3-44, 3-45, 3-48, 3-49, 3-51, 3-52, 3-54, 3-55, 3-57
REB-126-M6-EL	-	-	REL-2S32-RH-TP	IOP-2PSP32-N	3-39, 3-40, 3-43, 3-44, 3-47, 3-48, 3-50, 3-51, 3-53, 3-54	ROP-3P32-SC	IOP-3P32-N	3-40, 3-41, 3-44, 3-45, 3-48, 3-49, 3-51, 3-52, 3-54, 3-55, 3-57
REB-2P32-SC	REB-2P32-N	3-40, 3-43, 3-44, 3-53, 3-54, 3-57	REL-2S40-RH-TP	RELB-2S40-N	3-61	ROP-4P32-LW-SC	IOP-4P32-LW-N	3-41, 3-42, 3-45, 3-46, 3-49, 3-52, 3-55, 3-56, 3-58
REB-2S13-M6-EL	-	-	REL-2S40-SC	RELB-2S40-N	3-61			
REB-2S18-M6-EL	-	-	REL-2S40-TP	RELB-2S40-N	3-61			
REB-2S26-M6-EL	-	-	REL-2S86	ICN-2S86-SC	3-60			
REL-1P32-HL-SC	IOPA-1P32-HL-N	3-39, 3-43, 3-47, 3-50, 3-53	REL-3P32-HL	IOPA-3P32-HL-N	3-40, 3-41, 3-44, 3-45, 3-48, 3-49, 3-51, 3-52, 3-54, 3-55, 3-57			
REL-1P32-LW-SC	IOPA-1P32-LW-N	3-39, 3-43, 3-47, 3-50, 3-53	REL-3P32-HL-SC	IOPA-3P32-HL-N	3-40, 3-41, 3-44, 3-45, 3-48, 3-49, 3-51, 3-52, 3-54, 3-55, 3-57			
REL-1P32-RH-TP	ICN-1P32-N	3-39, 3-43, 3-47, 3-50, 3-53	REL-3P32-LW-RH-TP	IOPA-3P32-LW-N	3-40, 3-41, 3-44, 3-45, 3-48, 3-49, 3-51, 3-52, 3-54, 3-55, 3-57			
REL-1P32-SC	ICN-1P32-N	3-39, 3-43, 3-47, 3-50, 3-53	REL-3P32-LW-SC	IOPA-3P32-LW-N	3-40, 3-41, 3-44, 3-45, 3-48, 3-49, 3-51, 3-52, 3-54, 3-55, 3-57			

Discontinued Catalog Number to Replacement Number *Electronic Fluorescent*

Discontinued Catalog Number	Current Catalog Number	Page No.
ROP-4P32-SC	IOP-4P32-N	3-41, 3-42, 3-45, 3-46, 3-49, 3-52, 3-55, 3-56, 3-58
VCN-132-MC	ICN-132-MC	3-39, 3-43, 3-53
VCN-1P32	ICN-1P32-N	3-39, 3-43, 3-47, 3-50, 3-53
VCN-1P32-SC	ICN-1P32-N	3-39, 3-43, 3-47, 3-50, 3-53
VCN-1S28	ICN-2S28-T	3-30, 3-31
VCN-1S32-SC	IOP-1PSP32-N	3-39, 3-43, 3-47, 3-50, 3-53
VCN-1S40-SC	ICN-2S40-N	3-61
VCN-1TTP40-SC	ICN-1TTP40-SC	3-28
VCN-2M32-MC	ICN-2M32-MC	3-40, 3-44, 3-54
VCN-2P32	ICN-2P32-N	3-39, 3-40, 3-43, 3-44, 3-47, 3-48, 3-50, 3-51, 3-53, 3-54, 3-57
VCN-2P32-LW	IOPA-2P32-LW-N	3-39, 3-40, 3-43, 3-44, 3-47, 3-48, 3-50, 3-51, 3-53, 3-54, 3-57
VCN-2P32-SC	ICN-2P32-N	3-39, 3-40, 3-43, 3-44, 3-47, 3-48, 3-50, 3-51, 3-53, 3-54, 3-57
VCN-2P54-SC	ICN-2S54-N	3-27 to 29, 3-32 to 35, 3-68
VCN-2P59	IOP-2P59-N	3-59
VCN-2S28	ICN-2S28-T	3-30, 3-31
VCN-2S32-LW	IOP-2PSP32-LW-N	3-39, 3-40, 3-43, 3-44, 3-47, 3-48, 3-50, 3-51, 3-53, 3-54
VCN-2S32-SC	IOP-2PSP32-N	3-39, 3-40, 3-43, 3-44, 3-47, 3-48, 3-50, 3-51, 3-53, 3-54
VCN-2S40	ICN-2S40-N	3-61
VCN-2S40-SC	ICN-2S40-N	3-61
VCN-2S86	ICN-2S86-SC	3-60
VCN-2TTP40-SC	ICN-2TTP40-SC	3-28
VCN-3P32	ICN-3P32-N	3-40, 3-41, 3-44, 3-45, 3-48, 3-49, 3-51, 3-52, 3-54, 3-55, 3-57
VCN-3P32-LW-SC	IOPA-3P32-LW-N	3-40, 3-41, 3-44, 3-45, 3-48, 3-49, 3-51, 3-52, 3-54, 3-55, 3-57
VCN-3P32-SC	ICN-3P32-N	3-40, 3-41, 3-44, 3-45, 3-48, 3-49, 3-51, 3-52, 3-54, 3-55, 3-57
VCN-3S32-SC	IOP-3PSP32-SC	3-40, 3-41, 3-44, 3-45, 3-48, 3-49, 3-51, 3-52, 3-54, 3-55
VCN-3TTP40-SC	ICN-3TTP40-SC	3-28
VCN-4P32	ICN-4P32-N	3-41, 3-42, 3-45, 3-46, 3-49, 3-52, 3-55, 3-56, 3-58
VCN-4P32-LW-SC	IOPA-4P32-LW-N	3-41, 3-42, 3-45, 3-46, 3-49, 3-52, 3-55, 3-56, 3-58
VCN-4P32-SC	ICN-4P32-N	3-41, 3-42, 3-45, 3-46, 3-49, 3-52, 3-55, 3-56, 3-58
VCN-4S32-SC	IOP-4PSP32-SC	3-41, 3-42, 3-45, 3-46, 3-49, 3-52, 3-55, 3-56
VEL-175-S-TP	ICN-2P60-N	3-62
VEL-1P32-HL-SC	IOPA-1P32-HL-N	3-39, 3-43, 3-47, 3-50, 3-53
VEL-1P32-LW-SC	IOPA-1P32-LW-N	3-39, 3-43, 3-47, 3-50, 3-53

Discontinued Catalog Number	Current Catalog Number	Page No.
VEL-1P32-RH-TP	ICN-1P32-N	3-39, 3-43, 3-47, 3-50, 3-53
VEL-1P32-SC	ICN-1P32-N	3-39, 3-43, 3-47, 3-50, 3-53
VEL-1S32-RH-TP	IOP-1PSP32-N	3-39, 3-43, 3-47, 3-50, 3-53
VEL-1S40-RH-TP	ICN-2S40-N	3-61
VEL-1S40-SC	ICN-2S40-N	3-61
VEL-1S40-TP	ICN-2S40-N	3-61
VEL-1T32	ICF-2S18-HI-LD	3-22, 3-23, 3-25
VEL-1T42	ICF-2S18-HI-LD	3-22, 3-23, 3-25
VEL-2E75-S-TP	ICN-2P60-N	3-62
VEL-2P17-RH-TP	ICN-2P32-N	3-39, 3-40, 3-43, 3-44, 3-47, 3-48, 3-50, 3-51, 3-53, 3-54, 3-57
VEL-2P32-HL-RH-TP	IOPA-2P32-HL-N	3-39, 3-40, 3-43, 3-44, 3-47, 3-48, 3-50, 3-51, 3-53, 3-54, 3-57
VEL-2P32-HL-SC	IOPA-2P32-HL-N	3-39, 3-40, 3-43, 3-44, 3-47, 3-48, 3-50, 3-51, 3-53, 3-54, 3-57
VEL-2P32-LW-RH-TP	IOPA-2P32-LW-N	3-39, 3-40, 3-43, 3-44, 3-47, 3-48, 3-50, 3-51, 3-53, 3-54, 3-57
VEL-2P32-LW-SC	IOPA-2P32-LW-N	3-39, 3-40, 3-43, 3-44, 3-47, 3-48, 3-50, 3-51, 3-53, 3-54, 3-57
VEL-2P32-RH-TP	ICN-2P32-N	3-39, 3-40, 3-43, 3-44, 3-47, 3-48, 3-50, 3-51, 3-53, 3-54, 3-57
VEL-2P32-SC	ICN-2P32-N	3-39, 3-40, 3-43, 3-44, 3-47, 3-48, 3-50, 3-51, 3-53, 3-54, 3-57
VEL-2P50-SC	-	
VEL-2P59-HL	-	
VEL-2P59-SC	IOP-2P59-N	3-59
VEL-2P59-S-RH-TP	IOP-2P59-N	3-59
VEL-2P75-S	ICN-2P60-N	3-62
VEL-2Q18	ICF-2S18-HI-LD	3-22, 3-23, 3-25
VEL-2Q26	ICF-2S18-HI-LD	3-22, 3-23, 3-25
VEL-2S110	ICN-2S110-SC	3-63
VEL-2S32-LW-RH-TP	IOP-2PSP32-LW-N	3-39, 3-40, 3-43, 3-44, 3-47, 3-48, 3-50, 3-51, 3-53, 3-54
VEL-2S32-RH-TP	IOP-2PSP32-N	3-39, 3-40, 3-43, 3-44, 3-47, 3-48, 3-50, 3-51, 3-53, 3-54
VEL-2S40-RH-TP	ICN-2S40-N	3-61
VEL-2S40-SC	ICN-2S40-N	3-61
VEL-2S40-TP	ICN-2S40-N	3-61
VEL-2S86	ICN-2S86-SC	3-60
VEL-3P32-HL	IOPA-3P32-HL-N	3-40, 3-41, 3-44, 3-45, 3-48, 3-49, 3-51, 3-52, 3-54, 3-55, 3-57
VEL-3P32-HL-SC	IOPA-3P32-HL-N	3-40, 3-41, 3-44, 3-45, 3-48, 3-49, 3-51, 3-52, 3-54, 3-55, 3-57
VEL-3P32-LW-RH-TP	IOPA-3P32-LW-N	3-40, 3-41, 3-44, 3-45, 3-48, 3-49, 3-51, 3-52, 3-54, 3-55, 3-57
VEL-3P32-LW-SC	IOPA-3P32-LW-N	3-40, 3-41, 3-44, 3-45, 3-48, 3-49, 3-51, 3-52, 3-54, 3-55, 3-57

Discontinued Catalog Number	Current Catalog Number	Page No.
VEL-3P32-RH-TP	ICN-3P32-N	3-40, 3-41, 3-44, 3-45, 3-48, 3-49, 3-51, 3-52, 3-54, 3-55, 3-57
VEL-3P32-SC	ICN-3P32-N	3-40, 3-41, 3-44, 3-45, 3-48, 3-49, 3-51, 3-52, 3-54, 3-55, 3-57
VEL-3P32-TP	ICN-3P32-N	3-40, 3-41, 3-44, 3-45, 3-48, 3-49, 3-51, 3-52, 3-54, 3-55, 3-57
VEL-3S32-LW-RH-TP	IOP-3PSP32-LW-SC	3-40, 3-41, 3-44, 3-45, 3-48, 3-49, 3-51, 3-52, 3-54, 3-55
VEL-3S32-RH-TP	IOP-3PSP32-SC	3-40, 3-41, 3-44, 3-45, 3-48, 3-49, 3-51, 3-52, 3-54, 3-55
VEL-3S40-RH-TP	-	
VEL-3S40-TP	-	
VEL-4P32-2LS	-	
VEL-4P32-LW-RH-TP	IOPA-4P32-LW-N	3-41, 3-42, 3-45, 3-46, 3-49, 3-52, 3-55, 3-56, 3-58
VEL-4P32-LW-SC	IOPA-4P32-LW-N	3-41, 3-42, 3-45, 3-46, 3-49, 3-52, 3-55, 3-56, 3-58
VEL-4P32-RH-TP	ICN-4P32-N	3-41, 3-42, 3-45, 3-46, 3-49, 3-52, 3-55, 3-56, 3-58
VEL-4P32-SC	ICN-4P32-N	3-41, 3-42, 3-45, 3-46, 3-49, 3-52, 3-55, 3-56, 3-58
VEL-4P32-TP	ICN-4P32-N	3-41, 3-42, 3-45, 3-46, 3-49, 3-52, 3-55, 3-56, 3-58
VIC-132	IOP-1PSP32-N	3-39, 3-43, 3-47, 3-50, 3-53
VIC-132-TP	IOP-1PSP32-N	3-39, 3-43, 3-47, 3-50, 3-53
VIC-140-TP	ICN-2S40-N	3-61
VIC-2S32	IOP-2PSP32-N	3-39, 3-40, 3-43, 3-44, 3-47, 3-48, 3-50, 3-51, 3-53, 3-54
VIC-2S32-TP	IOP-2PSP32-N	3-39, 3-40, 3-43, 3-44, 3-47, 3-48, 3-50, 3-51, 3-53, 3-54
VIC-2S40-TP	ICN-2S40-N	3-61
VIC-3S32	IOP-3PSP32-SC	3-40, 3-41, 3-44, 3-45, 3-48, 3-49, 3-51, 3-52, 3-54, 3-55
VIC-3S32-TP	IOP-3PSP32-SC	3-40, 3-41, 3-44, 3-45, 3-48, 3-49, 3-51, 3-52, 3-54, 3-55
VIC-3S40-TP	-	
VOP-2P32-LW-SC	IOP-2P32-LW-N	3-39, 3-40, 3-43, 3-44, 3-47, 3-48, 3-50, 3-51, 3-53, 3-54, 3-57
VOP-2P32-SC	IOP-2P32-N	3-39, 3-40, 3-43, 3-44, 3-47, 3-48, 3-50, 3-51, 3-53, 3-54, 3-57
VOP-3P32-LW-SC	IOP-3P32-LW-N	3-40, 3-41, 3-44, 3-45, 3-48, 3-49, 3-51, 3-52, 3-54, 3-55, 3-57
VOP-3P32-SC	IOP-3P32-N	3-40, 3-41, 3-44, 3-45, 3-48, 3-49, 3-51, 3-52, 3-54, 3-55, 3-57
VOP-4P32-LW-SC	IOP-4P32-LW-N	3-41, 3-42, 3-45, 3-46, 3-49, 3-52, 3-55, 3-56, 3-58
VOP-4P32-SC	IOP-4P32-N	3-41, 3-42, 3-45, 3-46, 3-49, 3-52, 3-55, 3-56, 3-58

Discontinued Catalog Number to Replacement Number

Controllable Fluorescent

Low Frequency Fluorescent

Discontinued Catalog Number	Current Catalog Number	Page No.
HDF128T5	-	
HDF132T8	-	
HDF140T5	-	
HDF154T5	-	
HDF224T5	-	
HDF226T4	-	
HDF228T5	-	
HDF232T8	-	
HDF239T5	-	
HDF240T5	-	
HDF242T5	-	
HDF254T5	-	
HDF332T8	-	
HDF432T8	-	
IEZ-124-D	-	
ILV-2S32-SC	-	
ILV-4S32-G	-	
IZT-1T42-M2-BS	IZT-2S26-M5-BS	4-11
IZT-1T42-M2-LD	IZT-2S26-M5-LD	4-11
IZT-2Q26-M2-BS	IZT-2S26-M5-BS	4-11
IZT-2Q26-M2-LD	IZT-2S26-M5-LD	4-11
IZT-2S32-SC	IZT-2PSP32-SC	4-15
IZT-2T42-M3-BS	IZT-2T42-M5-BS	4-11
IZT-2T42-M3-LD	IZT-2T42-M5-LD	4-11
IZT-3S32-SC	IZT-3PSP32-SC	4-15
RDC-132-TP	IZT-132-SC	4-15
RDC-140-TP	-	
RDC-2BS40-TP	IZT-2TTS40-SC	4-12
RDC-2S32-TP	IZT-2PSP32-SC	4-15
RDC-2S40-TP	-	
RDC-3S32-TP	IZT-3PSP32-SC	4-15
RDC-3S40-TP	-	
REB-2S26-M1-BS-DIM	-	
REB-2S26-M1-LS-DIM	-	
REZ-132	REZ-132-SC	4-9
REZ-1Q18-M2-LD	-	
REZ-1T32	REZ-1T42-M2-LD-K	4-5
REZ-1T42	REZ-1T42-M2-LD-K	4-5
REZ-1TTS40	REZ-1TTS40-SC	4-6
REZ-2Q26	REZ-2Q26-M2-LD-K	4-5
REZ-2S32	REZ-2S32-SC	4-9
REZ-2TTS40	REZ-2TTS40-SC	4-6
REZ-3S32	REZ-3S32-SC	4-9
REZ-C1200-A	-	
REZ-C500-I	-	
RTR-2S32-SC	-	
RZT-132	IZT-132-SC	4-15

Discontinued Catalog Number	Current Catalog Number	Page No.
RZT-154	IZT-154-D	4-12, 4-14
RZT-1TTS40	-	
RZT-1TTS40-SC	-	
RZT-2S32	IZT-2PSP32-SC	4-15
RZT-2S54	IZT-2S54-D	4-12, 4-14
RZT-2TTS40	IZT-2TTS40-SC	4-12
RZT-3S32	IZT-3PSP32-SC	4-15
VDC-132-TP	IZT-132-SC	4-15
VDC-140-TP	-	
VDC-2BS40-TP	IZT-2TTS40-SC	4-12
VDC-2S32-TP	IZT-2PSP32-SC	4-15
VDC-2S40-TP	-	
VDC-3S32-TP	IZT-3PSP32-SC	4-15
VDC-3S40-TP	-	
VEZ-132	VEZ-132-SC	4-9
VEZ-1Q18-M2-LD	-	
VEZ-1T32	VEZ-1T42-M2-LD-K	4-5
VEZ-1T42	VEZ-1T42-M2-LD-K	4-5
VEZ-1TTS40	VEZ-1TTS40-SC	4-6
VEZ-2Q26	VEZ-2Q26-M2-LD-K	4-5
VEZ-2S32	VEZ-2S32-SC	4-9
VEZ-2TTS40	-	
VEZ-2TTS40-SC	-	
VEZ-3S32	VEZ-3S32-SC	4-9
VEZ-C1200-A	-	
VEZ-C500-I	-	
VTR-2S32-SC	-	
VZT-132	IZT-132-SC	4-15
VZT-154	IZT-154-D	4-12, 4-14
VZT-180	IZT-180-D	4-12, 4-14
VZT-1TTS40	-	
VZT-2S32	IZT-2PSP32-SC	4-15
VZT-2S54	IZT-2S54-D	4-12, 4-14
VZT-2TTS40-SC	IZT-2TTS40-SC	4-12
VZT-3S32	IZT-3PSP32-SC	4-15
VZT-4PSP32-G	IZT-4PSP32-G	4-15
VZT-4S32-4	IZT-4S32	4-15
VZT-4S32-8	IZT-4S32	4-15
VZT-4S32-G	IZT-4S32	4-15

Discontinued Catalog Number	Current Catalog Number	Page No.
GK-132-TP	-	
GK-2S110-TP	-	
GK-2S32-TP	-	
RK-132-TP	-	
RK-134-TP	-	
RK-2S110-TP	-	
RK-2S34-TP	-	
RK-2S40-TP	-	
RK-3S34-TP	-	
VK-132-TP	-	
VK-134-TP	-	
VK-2S34-TP	-	
VK-2S40-TP	-	
VK-3S34-TP	-	
YK-2S32-TP	-	

Discontinued Catalog Number to Replacement Number *HID*

Obsolete Catalog Numbers	Suggested Replacement Catalog Number	Page No.	Alternate Quadri-volt 120/208/240/277V	Obsolete Catalog Numbers	Suggested Replacement Catalog Number	Page No.	Alternate Quadri-volt 120/208/240/277V	Obsolete Catalog Numbers	Suggested Replacement Catalog Number	Page No.	Alternate Quadri-volt 120/208/240/277V
71A0201	71A0280	7-35	71A2803	71A4001
71A0401-791	71A2810	71A4020
71A0410	71A0490	7-35	71A0490	71A2820	71A4021
71A0430	71A0490	7-35	71A0490	71A2840	71A4030
71A0440	71A2960	71A4031
71A0450	71A0490	7-35	71A0490	71A3000	71A4040
71A04D0	71A0490	7-35	71A3001	71A4041
71A04F0	71A3002	71A4051
71A0540	71A05F0	7-36	71A3010	71A4061
71A0550	71A0590	7-36	71A0590	71A3011	71A4091
71A0560	71A0590	7-36	71A0590	71A3012	71A40D1
71A05D0	71A0590/05F0	7-36	71A3020	71A40J1
71A0740	71A07F0	7-36	71A3021	71A40R1
71A0750	71A0790	7-36	71A0790	71A3022	71A4142
71A0760	71A0790	7-36	71A0790	71A3030	71A4152
71A07D0	71A0790/07F0	7-36	71A3031	71A4310
71A1500	71A3032	71A4320
71A1510	71A3040	71A4401
71A1530	71A3041	71A4411
71A1540	71A3042	71A4421
71A1580	71A3050	71A4431
71A15R0	71A3052	71A4441
71A1800	71A3060	71A4451
71A1801	71A3062	71A5000
71A1810	71A3072	71A5005	71A5005-P	7-11
71A1820	71A3092	71A5030*
71A1830	71A30J2	71A5037	71A5037-P	7-11
71A2000	71A3140	71A5037-B	71A5037-BP	7-11
71A2020	71A3150	71A5050
71A2030	71A3301	71A5060
71A2080	71A3306	71A5090
71A20R0	71A3307	71A5090
71A2300	71A3320	71A50R0
71A2301	71A3325	71A50Y1
71A2303	71A3330	71A50Y5
71A2310	71A3335	71A5102
71A2320	71A3340	71A5105	71A5105-P	7-11
71A2330	71A3500	71A5122
71A2340	71A3501	71A5137	71A5137-P	7-11
71A2500	71A3502	71A5137-B	71A5137-BP	7-11
71A2501	71A3510	71A5142
71A2502	71A3520	71A5202
71A2510	71A3521	71A5205	71A5205-P	7-12
71A2512	71A3522	71A5227 (Reactor)	71A5292 (3x4 Core)
71A2520	71A3530	71A5228
71A2522	71A3531	71A5229 (Reactor)	71A5292 (3x4 Core)
71A2530	71A3532	71A5237	71A5237-P	7-12
71A2531	71A3540	71A5237-B	71A5237-BP	7-12
71A2532	71A3541	71A5281	71A52A1	7-12
71A2540	71A3542	71A5282	71A5292	7-12	71A5292
71A2541	71A3552	71A5283
71A2542	71A3562	71A5288
71A2551	71A3592	71A5289 (Reactor + Transformer)	71A5292 (3x4 Core)
71A2561	71A35J2	71A52C0
71A2571	71A35R2	71A52S7
71A2591	71A3640	71A5300	71A5390	7-13
71A25D1 (120/240/347V)	71A3650	71A5303	71A5383	7-13
71A25J1	71A3800	71A5337	71A5337-P	7-13
71A25M1	71A3810	71A5337-B	71A5337-BP	7-13
71A25N1	71A3820	71A5338
71A25R1	71A3825	71A5380	71A5390	7-13
71A2800	71A3825-791	71A5386
71A2801	71A3830				
71A2802	71A3840				
				71A4000				

* Availability limited to existing stocks.

** The CWA ballasts offered as replacements are furnished with a capacitor which must be used in the ballast circuit as shown in the wiring diagram in this Atlas. The original ballast circuit in the lighting fixture may have been low or normal power factor, and therefore, no capacitor was used. If the CWA ballast with its capacitor does not fit in the fixture, contact Philips for assistance.

Philips Advance replacement ballasts shown are functionally equivalent to listed obsolete ballasts. Dimensional differences can exist.

Suffix "T" ballast catalog numbers indicate ballast is equipped with 120V output tap. Standard practice is to use 120V tap on quadri-volt ballast, where quadri-volt ballasts are available.

Where no replacement ballast is shown, ballast has been discontinued and inventories are exhausted. Consult nearest Philips sales office for assistance.

Discontinued Catalog Number to Replacement Number *HID*

Obsolete Catalog Numbers	Suggested Replacement Catalog Number	Page No.	Alternate Quadri-volt 120/208/240/277V	Obsolete Catalog Numbers	Suggested Replacement Catalog Number	Page No.	Alternate Quadri-volt 120/208/240/277V	Obsolete Catalog Numbers	Suggested Replacement Catalog Number	Page No.	Alternate Quadri-volt 120/208/240/277V
71A5780	71A5770/90	7-5, 17	71A5770/90	71A6310 (Series)	71A5730	71A5770/90	7-5, 17	71A5770/90
71A5792	71A5792-EE	7-5, 18	71A6320 (Series)	71A5731	71A5771/91	7-5, 17	71A5771/91
71A5793	71A5792	7-5, 18	71A5792	71A6330 (Series)	71A5734
71A57A3	71A57A2	7-18	71A6340 (Series)	71A5737
71A57D0 (120/240/347V)	71A57A0 (120/277/347V)	7-17	71A5770/90	71A6342	71A5740	71A5750	7-17
71A57E6	71A5387 (Reactor + Transformer)	71A5390 (3x4 Core)	71A5744
71A57J0	71A5388	71A5756
71A57V0	71A53M0	71A5760	7-17	71A5770/90
71A5837	71A53Y3	71A5766
71A5841	71A5402	71A6352 (120/240V)
71A5842	71A5842-T	7-5, 19	71A5427 (Reactor)	71A5390 (3x4 Core)	71A6382
71A5843-T	71A5842-T	7-5, 19	71A5428 (Reactor)	71A5390 (3x4 Core)	71A63A3
71A5871	71A5429 (Reactor)	71A5392 (3x4 Core)	71A63J2
71A5880	71A5437	71A5437-P	7-14	71A6498
71A5893	71A5892	7-5, 19	71A5892	71A5437-B	71A5437-BP	7-14	71A64E2
71A58H2	71A5480	71A5490	7-14	71A5490	71A64F8
71A5937	71A5482	71A5492	7-14	71A5492	71A6500	7-23	71A6572/92
71A5942-T	71A5943-T	71A5486	71A6501	7-23	71A6572/92
71A5992	71A5993	7-5, 20	71A5993	71A5488 (Reactor + Autotransformer)	71A5490 (3x4 Core)	71A6502	71A6572/92	7-5, 23	71A6572/92
71A59A2	71A59A3	7-20	71A5489 (Reactor + Autotransformer)	71A5492 (3x4 Core)	71A6510	71A6590	7-23	71A6590
71A59N2	71A54CO	71A6511	71A6591	7-24	71A6591
71A59N3	71A54J9	71A6512	71A6572/92	7-5, 23	71A6572/92
71A6000	7-5, 20	71A6071/91	71A54M2	71A6520	71A6590	7-23	71A6590
71A6001	71A6071/91	7-5, 20	71A54Y2	71A6521	71A6591	7-24	71A6591
71A6004	71A5500	71A5570/90	7-5, 15	71A5570/90	71A6522	71A6572/92	7-5, 23	71A6572/92
71A6010	71A6071/91	7-5, 20	71A6071/91	71A5504	71A6530	71A6590	7-23	71A6590
71A6011	71A6071/91	7-5, 20	71A6071/91	71A5510	71A5570/90	7-5, 15	71A5570/90	71A6531	71A6591	7-24	71A6591
71A6020	71A6021	7-5	71A6071/91	71A5520	71A5570/90	7-5, 15	71A5570/90	71A6532	71A6572/92	7-5, 23	71A6572/92
71A6021	71A6071/91	7-5, 20	71A6071/91	71A5530	71A5570/90	7-5, 15	71A6540 (4x4)	71A65FOT (347/480/120T)	7-23	71A6542T (4x6)
71A6030	71A6031	71A6071/91	71A5534	71A6551 (4x4)	71A6553 (4x6)	7-24
71A6031	71A6071/91	7-5, 20	71A5541TEE (3x4)	71A5543TEE (4x4)	7-15	71A5543TEE (4x4)	71A6561	71A6591	7-24	71A6591
71A6034	71A5544	71A6571	71A6591	7-24	71A6591
71A6037	71A5540T	71A6586
71A6040	71A6041	7-5, 20	71A6071/91	71A5550	71A5570/90	7-5, 15	71A5570/90	71A65B2	71A65A2 (120/277/347V)	7-23
71A6043-T	71A6042-T	7-21	71A5560	71A5570/90	7-5, 15	71A5570/90	71A65D2 (120/240/347V)	71A65A2	7-23
71A6044	71A5580	71A5570/90	7-5, 15	71A65E3 (120/240/347V)
71A6056	71A5591EE (3x4)	71A5593EE (4x4)	7-15	71A5593EE (4x4)	71A65F3 (277/347/480V)	71A65F3-T (277/347/480V/120T)	7-24
71A6061	71A6071/91	7-5, 20	71A6071/91	71A5592	71A5593	7-5, 15	71A5593	71A65J2-M
71A6066	71A55A2	71A55A3	7-15	71A65M6
71A6081	71A6071/91	7-5, 20	71A55B0	71A55A0	7-15	71A65N3
71A6084 (120/277V)	71A55D0 (120/240/347V)	71A55A0 (120/277/347V)	7-15	71A5570/90	71A65Y6
71A6093	71A6092	7-5, 21	71A6092	71A55G0	71A55H0	7-15	71A6700	71A6772/92	7-5, 25	71A6772/92
71A60B1	71A60A1 (120/277/347V)	7-20	71A55J0	71A55H0	7-15	71A6701	71A6772/92	7-5, 25	71A6772/92
71A60D1 (120/240/347V)	71A60A1 (120/277/347V)	7-20	71A6071/91	71A55MO	71A6710	71A6772/92	7-5, 25	71A6772/92
71A60F6	71A55RO	71A55N0	7-59	71A6711	71A6772/92	7-5, 25	71A6772/92
71A60J1	71A60H1	7-20	71A5693	71A5692EE	7-5, 18	71A6712	71A6772/92	7-5, 25	71A6772/92
71A60J9	71A56A3	71A56A2	7-16	71A6720	71A6772/92	7-5, 25	71A6772/92
71A60M2	71A56J9	71A6721	71A6772/92	7-5, 25	71A6772/92
71A60S4	71A56N3	71A6722	71A6772/92	7-5, 25	71A6772/92
71A60V1	71A5700	71A5770/90	7-5, 17	71A5770/90	71A6730	71A6772/92	7-5, 25	71A6772/92
71A60Y1	71A5701	71A5771/91	7-5, 17	71A5771/91
71A61E6	71A5710	71A5770/90	7-5, 17	71A5770/90
71A6240	71A5711	71A5771/91	7-5, 17	71A5771/91
71A62E0	71A5720	71A5770/90	7-5, 17	71A5770/90
71A6300 (Series)	71A5721	71A5771/91	7-5, 17	71A5771/91

* Availability limited to existing stocks.

** The CWA ballasts offered as replacements are furnished with a capacitor which must be used in the ballast circuit as shown in the wiring diagram in this Atlas. The original ballast circuit in the lighting fixture may have been low or normal power factor, and therefore, no capacitor was used. If the CWA ballast with its capacitor does not fit in the fixture, contact Philips for assistance.

Philips Advance replacement ballasts shown are functionally equivalent to listed obsolete ballasts. Dimensional differences can exist.

Suffix "T" ballast catalog numbers indicate ballast is equipped with 120V output tap. Standard practice is to use 120V tap on quadri-volt ballast, where quadri-volt ballasts are available.

Where no replacement ballast is shown, ballast has been discontinued and inventories are exhausted.

Consult nearest Philips sales office for assistance.

Discontinued Catalog Number to Replacement Number *HID*

Obsolete Catalog Numbers	Suggested Replacement Catalog Number	Page No.	Alternate Quadri-volt 120/208/240/277V
71A6731	71A6772/92	7-5, 25	71A6772/92
71A6740	71A6742	7-5, 25
71A6753	71A6742	7-5, 25
71A6771	71A6772	7-5, 25	71A6772/92
71A6791	71A6792	7-5, 25	71A6772/92
71A67D2 (120/240/347V)	71A67A2 (120/277/347V)	7-25	71A6772/92
71A67J2
71A6890
71A68JO
71A69E5
71A69H0
71A7781
71A7805
71A7809
71A78R1
71A7900
71A8791	71A8773/93	7-7, 34	71A8773/93
71A87D3 (120/240/347V)	71A87A3 (120/277/347V)	7-34	71A8773/93
71A87J3
71A87V9
71A8900	7-31	71A8970/90
71A8930	7-31	71A8970/90
71A8931	7-31	71A8991
71A8940
71A8941
71A8950	71A8970/90	7-7, 31
71A8954
71A8964
71A8976	71A8970/90	7-7, 31
71A8984 (120/277V)	71A8970/90 (CWA)
71A9068
71A9073
71A9074
71A9082
71A9114
71A9115
71A9124
71A9127
71A9135
71A9136
71A9137
71A9138
71A9139
71A9189	71A0590	7-36
71A9192	71A0490	7-35
71A9209	71A5570/90	7-5, 15	71A5570/90
71A9212
71A9240
71A9242	71A5570/90
71A9243	71A5540	7-5, 15
71A9263
71A9278
71A9279
71A9301	71A07FO	7-36
71A9302	7-20	71A6071/91
71A9303	7-20	71A6071/91
71A9305	7-23	71A6572/92
71A9306
71A9312

Obsolete Catalog Numbers	Suggested Replacement Catalog Number	Page No.	Alternate Quadri-volt 120/208/240/277V
71A9313
71A9314
71A9315
71A9316
71A9317	71A0790	7-36
71A9318	71A0790	7-36
71A9319
71A9325
71A9326	71A07FO	7-36
71A9327	71A04FO	7-35
71A9328	71A05FO	7-36
71A9331
71A9332
71A9334
71A9335
71A9341	71A0590	7-36
71A9352
71A9355	71A0790	7-36
71A7901	71A7991	7-27	71A7991
71A7910*
71A7920
71A7931	71A7991	7-27	71A7991
71A7948
71A7950
71A7956	71A79E6 (120/208/240V)	7-27
71A7960 (240/480V)
71A79D1 (120/240/347V)	71A79A1 (120/277/347V)	7-27	71A7971/91
71A79S1
71A79T8
71A8000
71A8001	71A8091	7-6, 28	71A8091
71A8005
71A8021	71A8091	7-6, 28	71A8091
71A8030
71A8050
71A8056	71A80E6 (120/277/347)	7-28
71A8060 (240/480V)
71A8080
71A80B6
71A80D1 (120/240/347V)	71A80A1 (120/277/347V)	7-28	71A8071/91
71A80J9
71A80L1	71A8071/91	7-6, 28
71A80S1
71A80W1
71A8102	71A8192	7-29	71A8192
71A8106*	7-30	71A8176/96
71A8111	7-30	71A8176/96
71A8116*	7-30	71A8176/96
71A8127
71A8130
71A8131	71A8176/96	7-6, 30	71A8176/96
71A8136	71A8176/96	7-6, 30	71A8176/96
71A8141
71A8150
71A8151	7-6, 30	71A8176/96
71A8156	71A81E6 (120/208/240V)	7-30

Obsolete Catalog Numbers	Suggested Replacement Catalog Number	Page No.	Alternate Quadri-volt 120/208/240/277V
71A8160
71A8180
71A81B6
71A81D2 (120/240/347V)	71A81A2 (120/277/347V)	7-8, 29	71A8172/92
71A81L2
71A81R6
71A81S2
71A81W2
71A8201	71A8271/91	7-7, 32	71A8271/91
71A8211	71A8271/91	7-7, 32	71A8271/91
71A8221	71A8271/91	7-7, 32	71A8271/91
71A8230
71A8231	71A8271/91	7-7, 32	71A8271/91
71A8250 (120/240V)
71A8256	71A82E6 (120/208/240V)	7-32
71A8260 (240/480V)
71A8280
71A8281	71A8271/91	7-7, 32	71A8271/91
71A8290
71A8294 (120/208/240/277V)
71A82B1	71A82A1 (120/277/347V)	7-32
71A82B6
71A82D1 (120/240/347V)	71A82A1 (120/277/347V)	7-32	71A8271/91
71A82L1	71A8271/91	7-7, 32
71A82V1
71A82W1
71A8311	71A8351	7-33
71A8321	71A8351	7-33
71A8331	71A8351	7-33
71A8341	71A8351	7-33
71A8343
71A8350
71A8360
71A8371	71A8351	7-33
71A8391	71A8351	7-33
71A8392
71A8401	71A8473/93	7-7, 33	71A8473/93
71A8402	71A8473/93	7-7, 33	71A8473/93
71A8403	71A8473/93	7-7, 33
71A8411	71A8473/93	7-7, 33	71A8473/93
71A8412	71A8473/93	7-7, 33	71A8473/93
71A8413	71A8473/93	7-7, 33	71A8473/93
71A8420
71A8421	71A8473/93	7-7, 33	71A8473/93
71A8422	71A8473/93	7-7, 33	71A8473/93
71A8423	71A8473/93	7-7, 33	71A8473/93
71A8430
71A8431	71A8473/93	7-7, 33	71A8473/93
71A8432	71A8473/93	7-7, 33	71A8473/93
71A8433	71A8473/93	7-7, 33
71A8440
71A8441	71A8443	7-33
71A8442	71A8443	7-33
71A8450
71A8456	71A84E6 (120/208/240V)	7-33
71A8460
71A8471	7-7, 33	71A8473/93
71A8472	7-7, 33	71A8473/93
71A8480
71A8482	7-7, 33	71A8473/93

* Availability limited to existing stocks.

** The CWA ballasts offered as replacements are furnished with a capacitor which must be used in the ballast circuit as shown in the wiring diagram in this Atlas. The original ballast circuit in the lighting fixture may have been low or normal power factor, and therefore, no capacitor was used. If the CWA ballast with its capacitor does not fit in the fixture, contact Philips for assistance.

Philips Advance replacement ballasts shown are functionally equivalent to listed obsolete ballasts.

Dimensional differences can exist.

Suffix "T" ballast catalog numbers indicate ballast is equipped with 120V output tap. Standard practice is to use 120V tap on quadri-volt ballast, where quadri-volt ballasts are available.

Where no replacement ballast is shown, ballast has been discontinued and inventories are exhausted.

Consult nearest Philips sales office for assistance.

Discontinued Catalog Number to Replacement Number *HID*

Obsolete Catalog Numbers	Suggested Replacement Catalog Number	Page No.	Alternate Quadri-volt 120/208/240/277V	Obsolete Catalog Numbers	Suggested Replacement Catalog Number	Page No.	Alternate Quadri-volt 120/208/240/277V	Obsolete Catalog Numbers	Suggested Replacement Catalog Number	Page No.	Alternate Quadri-volt 120/208/240/277V
71A8484	71A9526	71A07F0	7-36	72C80C4
71A8490	71A9530	72C8IC5
71A8491	7-7, 33	71A8473/93	71A9532	72C9156
71A8492	7-7, 33	71A8473/93	71A9533	72C9159
71A84B6	71A9534	72C9160
71A84D3 (120/240/347V)	71A84A3 (120/247/347V)	7-33	71A8473/93	71A9545	71A8107	7-29	72C9163
71A84H3	71A9546	71A8007	7-28	72C9164
71A84J7	71A9547	71A7907	7-27	72C9167
71A84L3	71A8473/93	7-7, 33	71A8473/93	71A9590	7-30	71A8176/96	72C9168
71A84V3	71A9597	72C9171
71A84W2	71A9646	72C9221
71A8540	71A85F5	7-34	71A9665	72C9222
71A8590 (120/208/240/277V)	71A85E5 (120/208/240V)	7-34	71A85F5 (277/347/480)	71A9696	72C9223
71A85A3	71A9720	71A60HI	7-20	72C9224
71A85B0	71A9722	71A55H0	7-15	72E5005-NP	IMH50ALF	6-5
71A85E6	71A9733	72E5005-NP-BLS	IMH50ABLS	6-5
71A85F6	71A9734	73B5181
71A8703	71A8773/93	7-7, 34	71A8773/93	71A9735	73B5380
71A8733	71A8773/93	7-7, 34	71A8773/93	71A9737	73B5480
71A8741	71A8743	7-34	71A9740	73B5492	73B5482	7-48
71A8755	71A8753	7-34	71A9740-2T	73B54A3
71A8771	71A8773/93	7-7, 34	71A8773/93	71A9742	71A9743	7-44	73B5580	73B5590	7-48	73B5590
71A9356	71A0590	7-36	71A9744	73B5593	73B5591-EE	7-48
71A9357	71A0490	7-35	71A9745-2T	73B55A0
71A9359	71A0490	7-35	71A9748*	73B5692
71A9366	71A9770	73B5740
71A9377*	71A9775	73B5780	73B5790	7-48	73B5790
71A9378*	71A9784	71A57H0	7-17	73B57A0
71A9416	71A9787	73B57A2
71A9417	71A9789	73B58A2
71A9418	71A9791	73B5993
71A9424	71A65A2	7-23	71A9800 (120/277V)	73B6041
71A9432 (240/480V)	71A9808*	73B6042
71A9437 (240/480V)	71A9814	73B6081	73B6091	7-49	73B6091
71A9445	71A0490	7-35	71A9833	73B60A2
71A9446	71A9846	73B6542
71A9449	71A9847	73B6592	73B6590	7-49
71A9451	71A82H1	7-32	71A9863	73B65N2
71A9452	71A9876	71A9749	7-44	73B7705
71A9462	71A9877	71A9900	7-44	73B7901
71A9465	71A9884	73B8005
71A9467	71A9885	71A9862	7-44	73B8102
71A9468	71A9893	73B8188
71A9469	71A9907	71A8192	7-29	73B8281	73B8291	7-50
71A9470	71A9911	71A80J1	7-28	73B82A1
71A9471	71A9923	73B8483	73B8493	7-50
71A9473	71A9928	74P1801
71A9474	71A9932	74P1831-011
71A9475	71A9934	74P2001
71A9476	71A9945	71A8990	7-31	74P2321-011
71A9477	71A9947	71A8271	7-7, 32	74P2503
71A9487	71A9948	74P2513
71A9491	71A9951	74P2523
71A9492	70A87R3	7-60	71A9955	71A8196	7-30	74P2533
71A9494	71A9971	74P2802
71A9502(240/480V)	71A8241 (480V)	7-32	71A8271/91 (240V)	71A9969	74P2832
71A9519	72C2584	74P3003
71A9520	72C3084	74P3013
71A9521	72C5005	72C5081	7-45	74P3023
71A9522	71A7941	7-27	72C51C1	74P3033
71A9523	71A8041	7-28	72C52C1	74P3303
71A9524	72C54C1	74P3313
71A9525	72C55C1	74P3323
				72C57C2	74P3333
				72C5983-NP	74P3503
				72C8005				

* Availability limited to existing stocks.

** The CWA ballasts offered as replacements are furnished with a capacitor which must be used in the ballast circuit as shown in the wiring diagram in this Atlas. The original ballast circuit in the lighting fixture may have been low or normal power factor, and therefore, no capacitor was used. If the CWA ballast with its capacitor does not fit in the fixture, contact Philips for assistance.

Philips Advance replacement ballasts shown are functionally equivalent to listed obsolete ballasts. Dimensional differences can exist.

Suffix "T" ballast catalog numbers indicate ballast is equipped with 120V output tap. Standard practice is to use 120V tap on quadri-volt ballast, where quadri-volt ballasts are available.

Where no replacement ballast is shown, ballast has been discontinued and inventories are exhausted.

Consult nearest Philips sales office for assistance.

Discontinued Catalog Number to Replacement Number *HID*

Obsolete Catalog Numbers	Suggested Replacement Catalog Number	Page No.	Alternate Quadri-volt 120/208/240/277V
74P3533
74P5103	74P5104	7-51
74P7702	74P7703	7-52
74P7802	74P7803	7-52
74P7902	74P7903	7-52
74P7913
74P7923
74P7933
74P8002	74P8003	7-52
74P8103	74P8104	7-52
77K5570	77L5570	7-9
77K5892
77K5993
77K6051	77L6051	7-9
77K6071	77L6051	7-9
77K8172	77L8172	7-9
77K8473	77L8453	7-9
77L5292
77L7971
77L8071
78E3542-001
78E4041
78E4300 (Series)
78E4310 (Series)
78E4320 (ILO)
78E4330 (Series)
78E4340 (Series)
78E5040-001
78E5090-001
78E5330
78E5590
78E5591
78E5752
78E5852
78E5993
78E6041
78E6092	78E6052-EE	7-54
78E6300 (Series)
78E6310 (Series)
78E6320 (Series)
78E6330 (Series)
78E6340 (Series)
78E6351*
78E64E2
78E64F2
78E65A2
78E65F3
78E6593
78E8291
78E8391
78E8492	78E8493	7-53
78E8703
78E8743
78E8793
79W3092
79W3140
79W3150
79W3640
79W3650
79W4041
79W4300 (Series)	79W6351(ILO)	7-55
79W4320 (Series)	79W6351(ILO)	7-55
79W4330 (Series)
79W4340 (Series)	79W6341(ILO)	7-55
79W5090
79W6300 (Series)	79W6351(ILO)	7-55

Obsolete Catalog Numbers	Suggested Replacement Catalog Number	Page No.	Alternate Quadri-volt 120/208/240/277V
79W6310 (Series)
79W6320 (Series)	79W6351(ILO)	7-55
79W6330 (Series)
79W6340 (Series)	79W6341(ILO)	7-55
79W6381*
79W6541	79W6542	7-55
79W6591	79W6592	7-55
79W6526
79W6742
79W6792
79W8192
79W8241
79W8291
79W8463 (240/480V)	79W8443 (480V)	7-56	79W8493 (240V)
79W8492	79W8493	7-56
79W9256	79W6351	7-55
79W9499*
79W9500 (240/480V)
79W9502 (240/480V)
79W9503 (240/480V)	79W8443 (480V)	7-56	79W8493 (240V)

Ignitors

Obsolete Catalog Numbers	Suggested Replacement Catalog Number	Page No.	Alternate Quadri-volt 120/208/240/277V
LI500	LI501-H4-IC	7-42, 43
LI501-A	LI501-H4-IC	7-42, 43
LI501-B5	LI501-H4-IC	7-42, 43
LI501-E	LI501-J4-IC	7-42, 43
LI505-H4 (Cut-off)	LI501-H4-IC	7-42, 43
LI520-H5	LI522-H5-IC	7-40
LI521-H5	LI522-H5-IC	7-40
LI525-H6 (Cut-off)	LI522-H5-IC	7-40
LI530-H5	LI533-H4-IC	7-40
LI531-H5	LI533-H4-IC	7-40
LI532-H4	LI533-H4-IC	7-40
LI533-H4A	LI533-H4-IC	7-40
LI540-H4
LI550	LI551-H4-IC	7-42
LI551-B5	LI551-H4-IC	7-42
LI551-RS
LI555-H4 (Cut-off)	LI551-H4-IC	7-42
LI560-H5	LI561-H5-IC	7-40, 43
LI570	LI571-H5-IC	7-43

Electronic HID

Obsolete Catalog Numbers	Suggested Replacement Catalog Number	Page No.
ICW140MLS	ICW140QLS	6-7
ICW60NLS	ICW60QLS	6-7
ICW90MLS	ICW90QLS	6-7
IDCW45MLS	No Replacement
IDCW45QLS	No Replacement
IDCW60MLS	No Replacement
IDCW60QLS	No Replacement
IDCW90MLS	No Replacement
IDCW90QLS	No Replacement
IDCW140MLS	No Replacement
IDCW140QLS	No Replacement
IDMH210TLS	No Replacement
ILCW140MLS-6,-8,-10	No Replacement
ILCW60NLS-6,-8,-10	No Replacement
ILCW90MLS-6,-8,-10	No Replacement
IMH50A8LS (39W operation)	IMH39GBLS	6-4
IMH50A8LS (50W operation)	IMH50GBLS	6-5
IMH50ALF (39W operation)	IMH39GLF	6-4
IMH50ALF (50W operation)	IMH50GLF	6-5
IMH100ALF (100W operation)	IMH100BLF	6-5
IMH100ALF (70W operation)	IMH70DLF	6-5
IMH100A8LS (100W operation)	IMH100DBLS	6-5
IMH175C8LS (150W operation)	IMH150H8LS	6-5
IMH175C8LS (175W operation)	No Replacement
IMH175CFL (150W operation)	IMH150HLF	6-5
IMH175CFL (175W operation)	No Replacement
IMH210TLS	No Replacement
IMH39JLF	IMH39ELF	6-4
IMH70JLF	IMH70ELF	6-5
IMH200CLF	No Replacement
IWSN100C8LS	No Replacement
IWSN100CLF	No Replacement
IZTEMH4003PS	No Replacement
IZTEMH4003PSF	No Replacement
IZTEMH4003PSXJ	No Replacement
IZTMH150CLF	No Replacement
IZTSN150CLF	No Replacement
RCW140TLS	No Replacement
RCW45MLS	No Replacement
RCW60MLS	No Replacement
RCW90TLS	No Replacement
RLCW140MLS-6,-8,10	No Replacement
RLCW60MLS-6,-8,10	No Replacement
RLCW90TLS-6,-8,10	No Replacement
RMH20ELF	RMH20KLF	6-4
RMHG20KLF	IMHG20KLF	6-4
RMHG20KLF	IMHG20KLF	6-4

* Availability limited to existing stocks.

** The CWA ballasts offered as replacements are furnished with a capacitor which must be used in the ballast circuit as shown in the wiring diagram in this Atlas. The original ballast circuit in the lighting fixture may have been low or normal power factor, and therefore, no capacitor was used. If the CWA ballast with its capacitor does not fit in the fixture, contact Philips for assistance.

Philips Advance replacement ballasts shown are functionally equivalent to listed obsolete ballasts. Dimensional differences can exist.

Suffix "T" ballast catalog numbers indicate ballast is equipped with 120V output tap. Standard practice is to use 120V tap on quadri-volt ballast, where quadri-volt ballasts are available.

Where no replacement ballast is shown, ballast has been discontinued and inventories are exhausted.

Consult nearest Philips sales office for assistance.

Fluorescent Lamp to Ballast

Lamp Type	Ballast Type		
	Electronic		Electromagnetic
	High Frequency Page Number	Dimming Page Number	
CF13DD			5-8, 5-9
CF13DD/E	3-22	4-11, 4-18	
CF13DS			5-8, 5-9
CF13DS/E			
CF13DT/E	3-22	4-11, 4-18	
CF18DD			
CF18DD/E	3-22	4-5, 4-11, 4-18	
CF18DF			
CF18DT			
CF18DT/E	3-22	4-5, 4-11, 4-18	
CF24DF			
CF26DD			5-8, 5-9
CF26DD/E	3-22	4-5, 4-11, 4-18	
CF26DT			5-9
CF26DT/E	3-23	4-5, 4-11, 4-18	
CF32DT/E	3-24	4-5, 4-11, 4-18	
CF36DF			
CF42DT/E	3-24	4-5, 4-11, 4-18	
CF57DT/E	3-24	4-5, 4-11, 4-18	
CF5DS			5-8, 5-9
CF5DS/E			
CF70DT/E	3-24	4-5, 4-11, 4-18	
CF7DS			5-8, 5-9
CF7DS/E			
CF9DD			5-8, 5-9
CF9DS			5-8, 5-9
CF9DS/E			
CFM18W/2G10			
CFM24W/2G10			
CFM36W/2G10			
CFQ10W/G24q			
CFQ13W/G24d			
CFQ13W/G24q	3-22	4-11, 4-18	
CFQ13W/GX23			5-8, 5-9
CFQ18W/G24d			
CFQ18W/G24q	3-22	4-5, 4-11, 4-18	
CFQ20W/GX32d			
CFQ26W/G24d			5-8, 5-9
CFQ26W/G24q	3-22	4-5, 4-11, 4-18	
CFQ27W/GX32d			5-8
CFQ9W/G23			5-8, 5-9
CFS10W/GRI0q	3-25		
CFS16W/GRI0q	3-25		
CFS21W/GRI0q	3-25		
CFS28W/GRI0q	3-25		
CFS38W/GRI0q	3-25		
CFS55W/GRY10q			
CFT13W/2GX7			
CFT13W/GX23			5-8, 5-9
CFT5W/2G7			
CFT5W/G23			5-8, 5-9
CFT7W/2G7			
CFT7W/G23			5-8, 5-9
CFT9W/2G7			
CFT9W/G23			5-8, 5-9
CFTR13W/GX24q	3-23	4-11, 4-18	
CFTR18W/GX24d			
CFTR18W/GX24q	3-23	4-5, 4-11, 4-18	
CFTR26W/GX24d			5-9
CFTR26W/GX24q	3-23	4-5, 4-11, 4-18	
CFTR32W/GX24q	3-24	4-5, 4-11, 4-18	
CFTR42W/GX24q	3-24	4-5, 4-11, 4-18	
CFTR57W/GX24q	3-24	4-5, 4-11, 4-18	
CFTR70W/GX24q	3-24	4-5, 4-11, 4-18	
F10 2D/4P	3-25		
F13BX			5-8, 5-9
F13DBX/4P	3-22	4-11, 4-18	
F13DBX23T4			5-8, 5-9

Fluorescent Lamp to Ballast

Lamp Type	Ballast Type		
	Electronic		Electromagnetic
	High Frequency Page Number	Dimming Page Number	
F13DBXT4			
F13T5			
F13T8			5-4, 5-6
F13TBX/4P	3-23	4-11, 4-18	
F14T12			5-5, 5-6
F14T5	3-30	4-2, 4-7, 4-13, 4-20	
F14T8			5-4
F15T12			5-5, 5-6
F15T8			5-4, 5-6
F15T8/PLUS			
F15T8/XL			
F16 2D/4P	3-25		
F17T8	3-39 to 3-42	4-3, 4-9, 4-15, 4-22	
F18BX			5-8
F18BX/RS			
F18DBX/4P	3-22	4-5, 4-11, 4-18	
F18DBXT4			
F18T12/HO			
F18T8			5-4
F18TBX/4P	3-23	4-5, 4-11, 4-18	
F19T8			5-4
F20T12			5-5, 5-6
F21 2D/4P	3-25		
F21T5	3-30	4-2, 4-7, 4-13, 4-20	
F24T12			
F24T12/HO	3-64		
F24T5/HO	3-33	4-8, 4-14	
F25T12 (28-33")			5-5
F25T12 (36")			
F25T8	3-43 to 3-46	4-3, 4-9, 4-15, 4-22	
F26DBX/4P	3-23	4-5, 4-11, 4-18	
F26DBXT4			5-8, 5-9
F26TBX/4P	3-23	4-5, 4-11, 4-18	
F27BX/RS	3-27	4-6	
F28 2D/4P	3-25		
F28T5	3-30, 3-31	4-2, 4-7, 4-13, 4-20	
F30T12	3-61		
F30T12/HO	3-64		
F30T8			
F32T8	3-53 to 3-56	4-3, 4-9, 4-15, 4-22	
F32T8/ES (25W)	3-47 to 3-49	4-3	
F32T8/ES (28W)	3-50 to 3-52	4-3	
F32T8/ES (30W)			
F32T8/U6	3-53 to 3-56	4-3, 4-9, 4-15, 4-22	
F32TBX/4P	3-24	4-5, 4-11, 4-18	
F34T12	3-61		
F34T12/U	3-61		
F35T5	3-31	4-2	
F36T12			
F36T12/HO	3-64		
F38 2D/4P	3-25		
F39BX/RS	3-27	4-6, 4-12	
F39T5/HO	3-33	4-8, 4-14	
F40BX	3-28	4-6, 4-12	
F40T10			
F40T12	3-61		
F40T12/IS			
F40T12/U	3-61		
F40T17/IS			
F40T8	3-57, 3-58		
F42T12			

Fluorescent Lamp to Ballast

Lamp Type	Ballast Type		
	Electronic		Electromagnetic
	High Frequency Page Number	Dimming Page Number	
F42T12/HO	3-64		
F42T6			
F42TBX/4P	3-24	4-5, 4-11, 4-18	
F48PG17/VHO			5-3
F48T10/VHO			5-3
F48T12			
F48T12/ES			
F48T12/HO	3-63, 3-64		
F48T12/VHO			5-3
F48T5/VHO			
F48T8/HO	3-60, 3-64		
F48T8/VHO			
F4T5			5-4
F50BX/RS	3-28		
F54T5/HO	3-33 to 3-35	4-2, 4-8, 4-14, 4-21	
F54T5/HO/ES	3-33 to 3-35	4-2, 4-8, 4-14, 4-21	
F55 2D/4P			
F55BX	3-29	4-6, 4-12, 4-19	
F57QBX/4P	3-24	4-5, 4-11, 4-18	
F58T8	3-68		
F5BX			5-8, 5-9
F60T10/VHO			5-3
F60T12			
F60T12/HO	3-63, 3-64		
F60T12/VHO			5-3
F60T8/HO			
F64T12			
F64T12/HO	3-64		
F64T6			
F6T5			5-4
F70QBX/4P	3-24	4-5, 4-11, 4-18	
F70T8	3-68		
F72PG17/VHO			5-3
F72T10/VHO			5-3
F72T12	3-62		
F72T12/HO	3-63, 3-64		
F72T12/VHO			5-3
F72T8 (200mA)			
F72T8 (265mA)			
F72T8/HO	3-60, 3-64		
F7BX			5-8, 5-9
F80T5/HO	3-35	4-12	
F84T12			
F84T12/HO	3-64		
F8T5			5-4
F96PG17/HO/ES			5-3
F96PG17/VHO			5-3
F96T10/VHO			5-3
F96T12	3-62		
F96T12/ES	3-62		
F96T12/HO	3-63, 3-64		
F96T12/HO/ES	3-63, 3-64		
F96T12/VHO			5-3
F96T12/VHO/ES			5-3
F96T8 (200mA)			
F96T8 (265mA)	3-59		
F96T8/ES			
F96T8/HO	3-60, 3-64		
F9BX			5-8, 5-9
F9DBX23T4			5-8, 5-9

Fluorescent Lamp to Ballast

Lamp Type	Ballast Type		
	Electronic		Electromagnetic
	High Frequency Page Number	Dimming Page Number	
FB016T8	3-39 to 3-42	4-3, 4-9, 4-15, 4-22	
FB024T8	3-43 to 3-46	4-3, 4-9, 4-15, 4-22	
FB031T8	3-53 to 3-56	4-3, 4-9, 4-15, 4-22	
FC12T5	3-32		
FC12T5/HO	3-32	4-8, 4-14, 4-21	
FC12T9			5-7
FC16T9			5-7
FC6T9			5-7
FC8T9			5-7
FC9T5	3-32		
FO13T8/XP			
FT18DL			5-8
FT18DL/RS			
FT18W/2G11			5-8
FT18W/2G11/RS			
FT24DL	3-27	4-6	
FT24W/2G11	3-27	4-6	
FT36DL	3-27	4-6, 4-12	
FT36W/2G11	3-27	4-6, 4-12	
FT40DL/RS	3-28	4-6, 4-12	
FT40W/2G11/RS	3-28	4-6, 4-12	
FT50W/2G11/RS	3-28		
FT55DL	3-29	4-6, 4-12, 4-19	
FT55W/2G11	3-29	4-6, 4-12, 4-19	
FT80DL	3-29	4-12	
FT80W/2G11	3-29	4-12	
G15T8			
G30T8			
G64T5			
PL-C13W			
PL-C13W/4P	3-22	4-11, 4-18	
PL-C13W/USA			5-8, 5-9
PL-C15MM/22W			
PL-C15MM/28W			5-8
PL-C18W			
PL-C18W/4P	3-22	4-5, 4-11, 4-18	
PL-C26W			5-8, 5-9
PL-C26W/4P	3-23	4-5, 4-11, 4-18	
PL-H120W/4P			
PL-H60W/4P			
PL-H85W/4P			
PL-L18W			5-8
PL-L18W/TUV	3-67		
PL-L24W	3-27	4-6	
PL-L35WHO/TUV	3-67		
PL-L36W	3-27	4-6, 4-12	
PL-L36W/TUV	3-67		
PL-L40W	3-28	4-6, 4-12	
PL-L50W	3-28		
PL-L55W	3-29	4-6, 4-12, 4-19	
PL-L60WHO/TUV	3-67		
PL-L80W	3-29	4-12	
PL-L95WHO/TUV	3-67		
PL-Q 28W/4P	3-25		
PL-Q 38W/4P	3-25		
PL-S13W			5-8, 5-9
PL-S5W			5-8, 5-9
PL-S7W			5-8, 5-9
PL-S9W			5-8, 5-9
PL-T18W	3-23	4-5, 4-11, 4-18	
PL-T26W	3-23	4-5, 4-11, 4-18	
PL-T32W	3-24	4-5, 4-11, 4-18	
PL-T42W	3-24	4-5, 4-11, 4-18	
PL-T57W	3-24	4-5, 4-11, 4-18	
TUV36T5/HO	3-67		
TUV64T5/HO	3-67		

HID Lamp to Ballast

Lamp Description		Ballast Type								
		Core & Coil				Encapsulated Page Number	F-Can Page Number	Postline Page Number	Indoor Enclosed Page No.	Outdoor Weatherproof Page Number
Watts	ANSI Code	Electronic Page No.	Replacement Page Number	OEM Page No.	50 Hz Page Number					

Metal Halide

20	M or C156	6-4
22	C175	6-4
35/39	C179	6-4
35/39	M or C130	6-4	7-11	7-45
45	C196	6-7
50	M110	6-5	7-11	7-45	7-51
50 CDM Elite	C193	6-5
60	C187	6-7
70	M or C 98	6-5	7-12	7-59	7-48	7-45
70	M85	7-12	7-45
70	M143	6-5	7-12	7-59	7-45
70	M or C139	6-5	7-12	7-45
90	C188	6-7
100	M85	7-13	7-45
100	M90	6-5	7-13	7-59	7-48	7-45
100	M140, C191	6-5	7-13	7-59	7-48	7-45
100	CDM Elite C191	6-5
140	C189	6-7
145 (AllStart)	C192	7-15
150	M or C102	6-5	7-14	7-48	7-45
150	M107	7-15	7-59	7-45	7-55
150	M81	7-14	7-45
150	M or C142	6-5	7-14	7-48	7-45
175	M57	7-15	7-48	7-46	7-55
175 (Pulse-Start)	M137	7-15	7-48	7-46
175 (Pulse-Start)	M152	7-15	7-48	7-46
200 (Pulse-Start)	M136	7-16
205 (AllStart)	C184	7-17, 7-18	7-55
210	C183	6-8
250	M58	7-17	7-48	7-46	7-55
250	M80
250 (Pulse-Start)	M138	7-18	7-48	7-46
250 (Pulse-Start)	M153	7-18	7-48	7-46
250	M168	7-32
315	C182	6-8
320 (Pulse-Start)	M132	7-19	7-48	7-46
320 (Pulse-Start)	M154	7-19	7-59	7-48	7-46
330 (AllStart)	C185	7-20, 7-21	7-55
350 (Pulse-Start)	M131	7-20	7-48	7-46	7-54
400	M169	7-33
400	M59	7-20	7-59	7-49	7-46	7-54	7-55
400 (Pulse-Start)	M135	7-21	7-49	7-46	7-54
400 (Pulse-Start)	M155	7-21	7-49	7-46	7-54
450 (Pulse-Start)	M144	7-21
750 (Pulse-Start)	M149	7-22
860 (AllStart)	C194	7-23, 7-24
1000 (Pulse-Start)	M141	7-24	7-49	7-54
1000	M47	7-23	7-49	7-54	7-55
1500	M48	7-25	7-59

High Pressure Sodium

35	S76	7-26	7-52
50	S68	7-26	7-47	7-52
70	S62	7-27	7-60	7-47	7-52
100	S54	7-28	7-60	7-47	7-52
150 (55V)	S55	7-29, 7-30	7-60	7-47	7-52
150 (100V)	S56	7-30
200	S66	7-31
250	S50	7-32	7-60	7-50
310	S67	7-33
400	S51	7-33	7-60	7-50	7-53	7-56
430	S145
600	S106	7-34
750	S111	7-34
1000	S52	7-34	7-60	7-53	7-56

Low Pressure Sodium

18	L69	7-35
35	L70	7-35
55	L71	7-35
90	L72	7-36
135	L73	7-36
180	L74	7-36

Compact Fluorescent Lamp Reference Guide

Lamp Type	Lamp Watts	NEMA Lamp Designation	PHILIPS	GE	OSRAM/ SYLVANIA	PANASONIC	Page No.
2-Pin lamps with built-in starter							
Twin Tube	5W	CFT5W/G23	PL-S5W	F5BX	CF5DS	-	5-8, 5-9
	7W	CFT7W/G23	PL-S7W	F7BX	CF7DS	-	5-8, 5-9
	9W	CFT9W/G23	PL-S9W	F9BX	CF9DS	-	5-8, 5-9
	13W	CFT13W/GX23	PL-S13W	F13BX	CF13DS	-	5-8, 5-9
Quad Tube	9W	CFQ9W/G23	-	F9DBX23T4	CF9DD	-	5-8, 5-9
	13W	CFQ13W/GX23	PL-C13W/USA	F13DBX23T4	CF13DD	FDS13/2	5-8, 5-9
	13W	CFQ13W/G24d	PL-C13W	F13DBXT4	-	-	-
	18W	CFQ18W/G24d	PL-C18W	F18DBXT4	CF18DD	FDS18/2	-
	22W	CFQ20W/GX32d	PL-C15MM/22W	-	-	FDL22	-
	26W	CFQ26W/G24d	PL-C26W	F26DBXT4	CF26DD	FDS26/2	5-8, 5-9
Triple Tube	28W	CFQ27W/GX32d	PL-C15MM/28W	-	-	FDL28	5-8
	18W	CFTR18W/GX24d	-	-	CF18DT	-	-
26W	CFTR26W/GX24d	-	-	CF26DT	-	5-9	
4-Pin lamps							
Flat Tube	18W	CFM18W/2G10	-	-	CF18DF	-	-
	24W	CFM24W/2G10	-	-	CF24DF	-	-
	36W	CFM36W/2G10	-	-	CF36DF	-	-
Twin Tube	5W	CFT5W/2G7	-	-	CF5DS/E	-	-
	7W	CFT7W/2G7	-	-	CF7DS/E	-	-
	9W	CFT9W/2G7	-	-	CF9DS/E	-	-
	13W	CFT13W/2GX7	-	-	CF13DS/E	-	-
Quad Tube	10W	CFQ10W/G24q	-	-	-	FDS10/4	-
	13W	CFQ13W/G24q	PL-C13W/4P	F13DBX/4P	CF13DD/E	FDS13/4	3-22
	18W	CFQ18W/G24q	PL-C18W/4P	F18DBX/4P	CF18DD/E	FDS18/4	3-22
	26W	CFQ26W/G24q	PL-C26W/4P	F26DBX/4P	CF26DD/E	-	3-23
Triple Tube	13W	CFTR13W/GX24q	-	F13TBX/4P	CF13DT/E	-	3-23
	18W	CFTR18W/GX24q	PL-T18W	F18TBX/4P	CF18DT/E	FHT18	3-23
	26W	CFTR26W/GX24q	PL-T26W	F26TBX/4P	CF26DT/E	FHT26	3-23
	32W	CFTR32W/GX24q	PL-T32W	F32TBX/4P	CF32DT/E	FHT32	3-24
	42W	CFTR42W/GX24q	PL-T42W	F42TBX/4P	CF42DT/E	-	3-24
	57W	CFTR57W/GX24q	PL-T57W	F57QBX/4P	CF57DT/E	-	3-24
	60W		PL-H60W/4P	-	-	-	-
	70W	CFTR70W/GX24q	-	F70QBX/4P	CF70DT/E	-	3-24
	85W		PL-H85W/4P	-	-	-	-
120W		PL-H120W/4P	-	-	-	-	
2D	10W	CFS10W/GRI0q	-	F10 2D/4P	-	-	3-25
	16W	CFS16W/GRI0q	-	F16 2D/4P	-	-	3-25
	21W	CFS21W/GRI0q	-	F21 2D/4P	-	-	3-25
	28W	CFS28W/GRI0q	PL-Q 28W/4P	F28 2D/4P	-	-	3-25
	38W	CFS38W/GRI0q	PL-Q 38W/4P	F38 2D/4P	-	-	3-25
	55W	CFS55W/GRY10q	-	F55 2D/4P	-	-	-
Long Twin Tube	18W	FT18W/2G11	PL-L18W	F18BX	FT18DL	-	5-8
	18W	FT18W/2G11/RS	-	F18BX/RS	FT18DL/RS	-	-
	24-27W	FT24W/2G11	PL-L24W	F27BX/RS	FT24DL	-	3-27
	36-39W	FT36W/2G11	PL-L36W	F39BX/RS	FT36DL	-	3-27
	40W	FT40W/2G11/RS	PL-L40W	F40BX	FT40DL/RS	-	3-28
	50W	FT50W/2G11/RS	PL-L50W	F50BX/RS	-	-	3-28
	55W	FT55W/2G11	PL-L55W	F55BX	FT55DL	-	3-29
	80W	FT80W/2G11	PL-L80W	-	FT80DL	-	3-29



©2016 Philips Lighting Holding B.V. All rights reserved. Philips reserves the right to make changes in specifications and/or to discontinue any product at any time without notice or obligation and will not be liable for any consequences resulting from the use of this publication.

PAd-1522BR 03/16 philips.com/oemna

Philips Lighting
North America Corporation
10275 W. Higgins Road
Rosemont, IL 60018
Tel: 800-322-2086
Fax: 888-423-1882
Customer Support/
Technical Service: 800-372-3331
OEM Support: 866-915-5886

Philips Lighting Canada Ltd.
281 Hillmount Rd,
Markham, ON, Canada L6C 2S3
Tel. 800-668-9008