

RFS Microwave Antennas

A Comprehensive Selection Guide

Edition 2

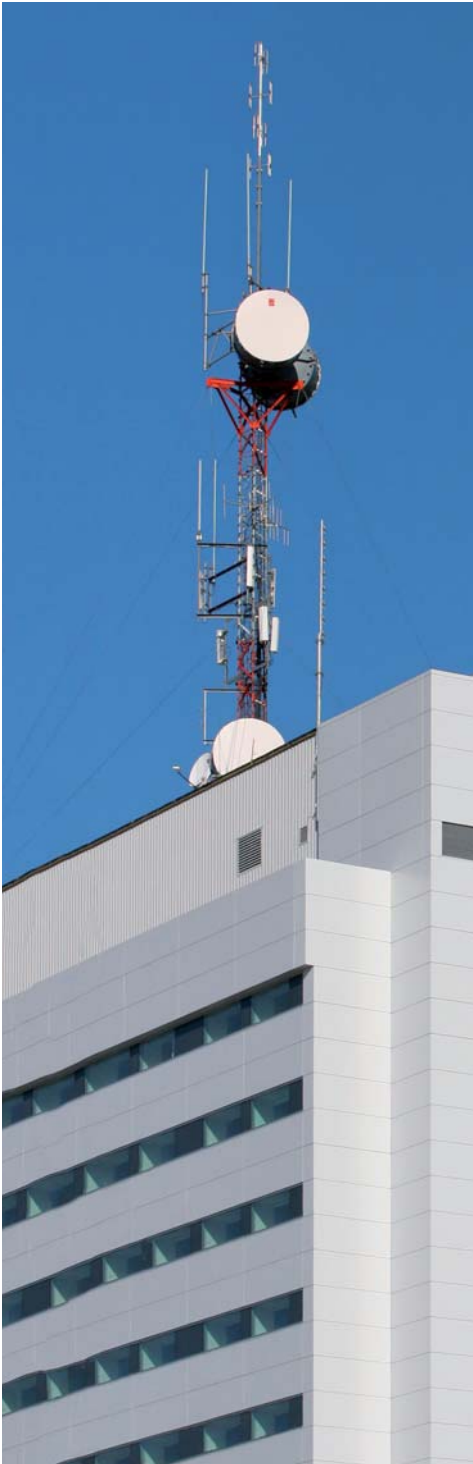

RADIO FREQUENCY SYSTEMS
The Clear Choice®



Table of contents

PAGE 1

RFS offers a complete portfolio of microwave antennas to meet all of your needs

PAGE 2 TO 5

Compact antennas optimized for integrated applications (SB and SC)

PAGE 6 TO 9

Antennas for long distances and high capacity applications (UA, DA, PAD)

PAGE 10 TO 13

Dual polarized antennas delivering ultra high performance and the highest XPD (UXA)

PAGE 14 TO 17

Robust antennas for the harshest environments

PAGE 18

Glossary

PAGE 19

Mechanical, environmental and electrical testing

PAGE 20

Understanding RFS model names

PAGE 21

Why RFS?

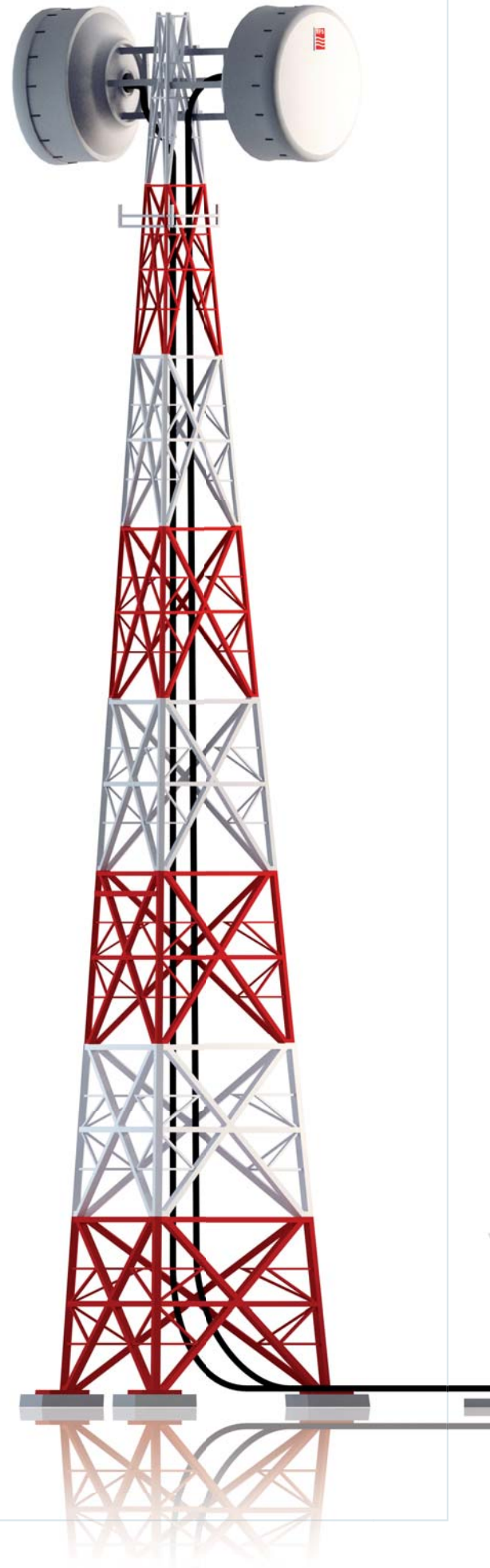

RFS offers a complete portfolio of microwave antennas to meet all of your needs

RFS offers four types of microwave antennas, each one designed for a specific application in your network. Together, our complete portfolio of microwave antennas takes your network from rooftops in dense urban areas, through suburbs and across long stretches of land to the harshest mountaintop and seaside environments.

Whether you are a telecom operator, a telecom manufacturer, a government agency, an enterprise or a strategic industry, RFS offers microwave antennas that support your applications and deliver dependable performance at low total cost of ownership (TCO):

- ⊕ Stringent design and quality testing procedures ensure that every RFS microwave antenna meets or exceeds electrical, mechanical and environmental performance standards with no compromises and no surprises.
- ⊕ Simplified installation and deployment procedures, low maintenance and long-term reliability keep post-purchase costs to a minimum. Compact packaging keeps transportation costs low.
- ⊕ Modular designs let you “pay as you grow”, evolving antennas and adding capacity as needed without the cost of replacing the antenna.

We also offer a full range of options and accessories for each antenna type to support your end-to-end radio link network (RLN). With manufacturing facilities and teams around the world, RFS is ready to serve customers in any location.







RFS offers four types of microwave antennas to meet all of your needs

⊕ **CompactLine and CompactLine Easy:**
Compact antennas optimized for integrated applications.

⊕ **TrunkLine:**
Large antennas for long distances and high-capacity applications.

⊕ **PrimeLine:** Dual-polarized antennas delivering ultra-high performance and the highest cross-polarization discrimination (XPD).

⊕ **Harsh Areas Line:**
Robust antennas that can withstand the harshest environmental conditions.

Size ft (m)	1 (0.3)		2 (0.6)		3 (0.9)		4 (1.2)		6 (1.8)		8 (2.4)		10 (3.0)		12 (3.7)		15 (4.6)	
Polarizations	single	dual	single	dual	single	dual	single	dual	single	dual	single	dual	single	dual	single	dual	single	dual
Antennas (Prefix)	CompactLine (SB & SBX) 										TrunkLine Class 3 (UA & UDA) 							
	SB1	SBX1	SB2 ¹	SBX2 ¹	SB3 ¹	SBX3 ¹	SB4	SBX4	SB6	SBX6	UA8	UDA8	UA10	UDA10	UA12	UDA12	UA15	UDA15
	CompactLine EASY (SC & SCX) 				TrunkLine Class 2 (DA & DAX) 													
			SC2	SCX2	SC3	SCX3			DA6	DAX6	DA8	DAX8	DA10	DAX10	DA12	DAX12	DA15	DAX15
											Trunkline FCC A (PAD ² & PADX ²) 							
									PAD6	PADX6	PAD8	PADX8	PAD10	PADX10				
										PrimeLine (UXA) 								
		-	UXA2	-	-	-	UXA4	-	UXA6	-	UXA8	-	UXA10	-	UXA12	-	UXA15	
										Harsh Areas Line (SU & SUX, DA & DAX) 								
		SU2	SUX2	-	-	SU4	SUX4	SU6	SUX6	DA8	DAX8	DA10	DAX10	DA12	DAX12			

Additional antenna variants and customized antenna versions are also available. They include:

⊕ Non-parabolic antennas, such as lens antennas that are available in some frequencies

⊕ Antennas that support higher wind speeds

⊕ Antennas that are not part of the RFS Harsh Areas Line but are custom-treated with our harsh environment protective coatings

⊕ Antennas that are manufactured in our US facility and optimized for North American standards

⊕ Antennas with different colors, flanges and mounting options such as those required for 219 mm pipe

Please contact your RFS representative to discuss your specific requirements and identify the RFS antenna that best fits your needs.

¹ Progressively phased out and replaced by new generation ² Available in North America only

RFS CompactLine (SB) & CompactLine EASY (SC)

Compact antennas optimized for integrated applications

Designed for: Dense urban areas, metropolitan and suburban locations, aggregation points

Installed on: Rooftop poles or towers

Featuring:

- ➔ Support for integrated radios to **reduce costs**, installation complexity and time
- ➔ Tested and validated **ultra-high** (ETSI EN 302 217 Class 3, FCC Class A) **electrical performance**
- ➔ Low-profile design to **reduce transportation requirements, wind load and antenna weight**
- ➔ Simplified mounting design to **accelerate installation**
- ➔ Hardcover radomes
- ➔ Support for **winds up to 252 km/h** (155 mph)
Note: Antennas 1.2 m (4 ft) and larger support wind speeds up to 200 km/h (125 mph) by default but can be enhanced to support winds up to 252 km/h (155 mph)
- ➔ Supports for **winds up to 320 km/h** (198 mph) on the new SB1/SBX1 antennas
Note: SB1/SBX1 revision C has been introduced in July 2013
- ➔ An **optional sway bar** for antennas 0.9 m (3 ft) and larger for added assurance in case mistakes are made during installation

Available in:

- ➔ Frequencies ranging **from 5.925 GHz to 52.6 GHz** with support for three wideband frequency ranges (5.925-7.125, 7.125-8.5 and 10-11.7) to reduce antenna requirements and simplify logistics
- ➔ Sizes ranging **from 0.3 m (1 ft) to 1.8 m (6 ft)**
- ➔ **Single- and dual-polarized** models with the ability to upgrade from single to dual polarization and change frequencies in the field¹ **CompactLine EASY models**, which are **extra light and easy** to transport, deploy and upgrade



¹ Please contact your RFS representative to verify which RFS CompactLine antenna models support these upgrades in the field.

Integrated radios, compact design minimize TCO

Antenna models

Frequency Range (GHz)	Sizes (m)	Sizes (ft)	Model Name (Single Polarized)	Model Name (Dual Polarized)
5.925-7.125	0.9	3	SC3-W60 ^{1,2}	SCX3-W60 ^{1,2}
	1.2	4	SB4-W60 ¹	SBX4-W60 ¹
	1.8	6	SB6-W60 ¹	SBX6-W60 ¹
7.125-8.5	0.6	2	SC2-W71 ¹	SCX2-W71 ¹
	0.9	3	SC3-W71 ¹	SCX3-W71 ¹
	1.2	4	SB4-W71 ¹	SBX4-W71 ¹
10-11.7	0.6	2	SC2-W100 ¹	SCX2-W100 ¹
	0.9	3	SC3-W100 ¹	SCX3-W100 ¹
	1.2	4	SB4-W100 ¹	SBX4-W100 ¹
12.7-13.25	0.3	1	SB1-127	SBX1-127
	0.6	2	SC2-127	SCX2-127
	0.9	3	SC3-127	SCX3-127
14.2-15.35	1.2	4	SB4-127	SBX4-127
	1.8	6	SB6-127	SBX6-127
	0.3	1	SB1-142	SBX1-142
17.7-19.7	0.6	2	SC2-142	SCX2-142
	0.9	3	SC3-142	SCX3-142
	1.2	4	SB4-142	SBX4-142
21.2-23.6	1.8	6	SB6-142	SBX6-142
	0.3	1	SB1-190	SBX1-190
	0.6	2	SC2-190	SCX2-190
24.25-26.5	0.9	3	SC3-190	SCX3-190
	1.2	4	SB4-190	SBX4-190
	1.8	6	SB6-190	SBX6-190
27.5-29.5	0.3	1	SB1-220	SBX1-220
	0.6	2	SC2-220	SCX2-220
	0.9	3	SC3-220	SCX3-220
31-33.4	1.2	4	SB4-220	SBX4-220
	1.8	6	SB6-220	SBX6-220
	0.3	1	SB1-250	SBX1-250
37-40	0.6	2	SC2-250	SCX2-250
	0.9	3	SC3-250	SCX3-250
	1.2	4	SB4-250	SBX4-250
40.5-43.5	0.3	1	SB1-280	SBX1-280
	0.6	2	SC2-280	SCX2-280
	0.3	1	SB1-320	SBX1-320
51.2-52.6	0.6	2	SC2-320	SCX2-320
	0.3	1	SB1-380	SBX1-380
	0.6	2	SC2-380	SCX2-380
	0.3	1	SB1-420	SBX1-420
	0.6	2	SC2-420	SCX2-420
	0.3	1	SB1-520	NA

This table summarizes the main RFS CompactLine (SB) and CompactLine EASY (SC) antenna models.

Additional antenna variants and customized versions are also available.

For example, variants that support specific vendor's radios are available.

To confirm proper ordering models, please contact your RFS representative.

¹ Wideband model

² Planned for 1Q14

Performance specifications

Note: The specifications for the SB1/SBX1 (revision C) and SC2/SCX2 (revision B) reflect the new generation introduced in July 2013. Visit our on-line e-catalog dataXpress for the latest and most complete data specifications: www.rfsworld.com/dataXpress

Frequency (GHz)	Polarization	Model Number	Diameter m (ft)	Gain (dBi)			3 dB-BW (deg)	VSWR/R L (dB)	X-Pol (dB)	IPI (dB)	F/B (dB)	ETSI RPE class	US FCC 101 Cat	Fine Adjust.		Windspeed km/h (mph)		Net weight kg (lb)
				Low	Mid	High								Az	Elev	Operational	Survival	
5.925 to 7.125	Single	SC3-W60 ³	0.9 (3)	32.0	33.2	33.9	3.00	1.38 (16.0)	30		61	3	B2	±15	±15	180 (112)	252 (155)	21 (47)
		SB4-W60	1.2 (4)	34.5	34.8	35.5	2.8	1.30 (17.7)	30		60	3	B2	±5	±15	200 (125)	200 (125)	35 (77)
		SB6-W60	1.8 (6)	38.0	38.8	39.4	1.7	1.30 (17.7)	30		65	3	A	±5	±5	200 (125)	200 (125)	90 (198)
	Dual	SCX3-W60 ³	0.9 (3)	32.0	33.2	33.9	3.00	1.38 (16.0)	30	35	60	3	B2	±15	±15	180 (112)	252 (155)	21 (47)
		SBX4-W60	1.2 (4)	34.5	34.8	35.5	2.8	1.30 (17.7)	30	35	61	3	B2	±5	±15	200 (125)	200 (125)	35 (77)
		SBX6-W60	1.8 (6)	38.0	38.8	39.4	1.7	1.30 (17.7)	30	35	65	3	A	±5	±5	200 (125)	200 (125)	90 (198)
7.125 to 8.5	Single	SC2-W71	0.6 (2)	30.5	31.3	31.9	4.3	1.38 (16.0)	30		57	3		±15	±20	180 (112)	252 (155)	9 (20)
		SC3-W71	0.9 (3)	34.7	35.6	35.8	2.6	1.38 (16.0)	30		62	3		±15	±15	180 (112)	252 (155)	18 (40)
		SB4-W71	1.2 (4)	36.2	36.9	37.6	2.3	1.30 (17.7)	30		63	3		±5	±15	200 (125)	200 (125)	35 (77)
		SB6-W71	1.8 (6)	40.1	40.6	41.1	1.5	1.30 (17.7)	30		67	3		±5	±5	200 (125)	200 (125)	90 (198)
		SBX6-W71	1.8 (6)	40.1	40.6	41.1	1.5	1.30 (17.7)	30	35	67	3		±5	±5	200 (125)	200 (125)	90 (198)
	Dual	SCX2-W71	0.6 (2)	30.5	31.3	31.9	4.3	1.38 (16.0)	30	35	57	3		±15	±20	180 (112)	252 (155)	9 (20)
		SCX3-W71	0.9 (3)	34.7	35.6	35.8	2.6	1.38 (16.0)	30	35	62	3		±15	±15	180 (112)	252 (155)	18 (40)
		SBX4-W71	1.2 (4)	36.2	36.9	37.6	2.3	1.30 (17.7)	30	35	63	3		±5	±15	200 (125)	200 (125)	35 (77)
		SBX6-W71	1.8 (6)	40.1	40.6	41.1	1.5	1.30 (17.7)	30	35	67	3		±5	±5	200 (125)	200 (125)	90 (198)
10 to 11.7	Single	SC2-W100	0.6 (2)	33.8	34.5	35.2	3.2	1.38 (16.0)	30		61	3	A/B ¹	±15	±20	180 (112)	252 (155)	9 (20)
		SC3-W100	0.9 (3)	37.6	38.3	39.1	2.0	1.38 (16.0)	30		64	3	A	±15	±15	180 (112)	252 (155)	18 (40)
		SB4-W100	1.2 (4)	39.4	39.9	40.3	1.5	1.30 (17.7)	30		66	3	A	±5	±15	200 (125)	200 (125)	35 (77)
		SB6-W100	1.8 (6)	42.7	43.4	43.9	1.0	1.30 (17.7)	30		70	3	A	±5	±5	200 (125)	200 (125)	90 (198)
		SBX6-W100	1.8 (6)	42.7	43.4	43.9	1.0	1.30 (17.7)	30	35	70	3	A/B ¹	±15	±20	180 (112)	252 (155)	9 (20)
	Dual	SCX3-W100	0.9 (3)	37.6	38.3	39.1	2.0	1.38 (16.0)	30	35	64	3	A	±15	±15	180 (112)	252 (155)	18 (40)
		SBX4-W100	1.2 (4)	39.4	39.9	40.3	1.5	1.30 (17.7)	30	35	66	3	A	±5	±15	200 (125)	200 (125)	35 (77)
		SBX6-W100	1.8 (6)	42.7	43.4	43.9	1.0	1.30 (17.7)	30	35	70	3	A	±5	±5	200 (125)	200 (125)	90 (198)
		SBX6-W100	1.8 (6)	42.7	43.4	43.9	1.0	1.30 (17.7)	30	35	70	3	A	±5	±5	200 (125)	200 (125)	90 (198)
12.7 to 13.25	Single	SB1-127	0.3 (1)	31.2	31.5	31.8	4.5	1.38 (16.0)	30		57	3		±15	±20	252 (155)	320 (198)	6 (13)
		SC2-127	0.6 (2)	35.8	36.0	36.2	2.7	1.38 (16.0)	30		62	3		±15	±20	180 (112)	252 (155)	9 (20)
		SC3-127	0.9 (3)	39.9	40.0	40.1	1.6	1.38 (16.0)	30		66	3	A	±15	±15	180 (112)	252 (155)	18 (40)
		SB4-127	1.2 (4)	41.7	41.9	42.1	1.3	1.30 (17.7)	30		68	3	A	±5	±15	200 (125)	200 (125)	35 (77)
		SB6-127	1.8 (6)	45.1	45.4	45.7	0.9	1.30 (17.7)	30		72	3	A	±5	±5	200 (125)	200 (125)	90 (198)
		SBX1-127	0.3 (1)	31.2	31.5	31.8	4.5	1.38 (16.0)	30	35	57	3		±15	±20	252 (155)	320 (198)	6 (13)
	Dual	SCX2-127	0.6 (2)	35.8	36.0	36.2	2.7	1.38 (16.0)	30	35	62	3		±15	±20	180 (112)	252 (155)	9 (20)
		SCX3-127	0.9 (3)	39.9	40.0	40.1	1.6	1.38 (16.0)	30	35	66	3	A	±15	±15	180 (112)	252 (155)	18 (40)
		SBX4-127	1.2 (4)	41.7	41.9	42.1	1.3	1.30 (17.7)	30	35	68	3	A	±5	±15	200 (125)	200 (125)	35 (77)
		SBX6-127	1.8 (6)	45.1	45.4	45.7	0.9	1.30 (17.7)	30	35	72	3	A	±5	±5	200 (125)	200 (125)	90 (198)
		SBX6-127	1.8 (6)	45.1	45.4	45.7	0.9	1.30 (17.7)	30	35	72	3	A	±5	±5	200 (125)	200 (125)	90 (198)
		SBX6-127	1.8 (6)	45.1	45.4	45.7	0.9	1.30 (17.7)	30	35	72	3	A	±5	±5	200 (125)	200 (125)	90 (198)
14.2 to 15.35	Single	SB1-142	0.3 (1)	32.0	32.1	32.2	4.2	1.30 (17.7)	30		55	2		±15	±20	252 (155)	320 (198)	6 (13)
		SC2-142	0.6 (2)	36.7	37.1	37.3	2.3	1.38 (16.0)	30		65	3		±15	±20	180 (112)	252 (155)	9 (20)
		SC3-142	0.9 (3)	40.6	41.0	41.3	1.5	1.38 (16.0)	30		69	3		±15	±15	180 (112)	252 (155)	18 (40)
		SB4-142	1.2 (4)	42.7	42.9	43.1	1.1	1.30 (17.7)	30		72	3		±5	±15	200 (125)	200 (125)	35 (77)
		SB6-142	1.8 (6)	45.9	46.2	46.5	0.8	1.30 (17.7)	30		74	3		±5	±5	200 (125)	200 (125)	90 (198)
		SBX1-142	0.3 (1)	32.0	32.1	32.2	4.2	1.30 (17.7)	30	35	55	2		±15	±20	252 (155)	320 (198)	6 (13)
	Dual	SCX2-142	0.6 (2)	36.7	37.1	37.3	2.3	1.38 (16.0)	30	35	65	3		±15	±20	180 (112)	252 (155)	9 (20)
		SCX3-142	0.9 (3)	40.6	41.0	41.3	1.5	1.38 (16.0)	30	35	69	3		±15	±15	180 (112)	252 (155)	18 (40)
		SBX4-142	1.2 (4)	42.7	42.9	43.1	1.1	1.30 (17.7)	30	35	72	3		±5	±15	200 (125)	200 (125)	35 (77)
		SBX6-142	1.8 (6)	45.9	46.2	46.5	0.8	1.30 (17.7)	30	35	74	3		±5	±5	200 (125)	200 (125)	90 (198)
		SBX6-142	1.8 (6)	45.9	46.2	46.5	0.8	1.30 (17.7)	30	35	74	3		±5	±5	200 (125)	200 (125)	90 (198)
		SBX6-142	1.8 (6)	45.9	46.2	46.5	0.8	1.30 (17.7)	30	35	74	3		±5	±5	200 (125)	200 (125)	90 (198)
17.7 to 19.7	Single	SB1-190	0.3 (1)	33.8	34.2	35.2	3.4	1.30 (17.7)	30		56	2	B2	±15	±20	252 (155)	320 (198)	6 (13)
		SC2-190	0.6 (2)	38.5	39.0	39.5	1.8	1.38 (16.0)	30		68	3	A	±15	±20	180 (112)	252 (155)	9 (20)
		SC3-190	0.9 (3)	42.8	43.3	43.8	1.1	1.38 (16.0)	30		71	3	A	±15	±15	164 (102)	252 (155)	18 (40)
		SB4-190	1.2 (4)	44.2	44.7	45.2	1.0	1.30 (17.7)	30		72	3	A	±5	±15	200 (125)	200 (125)	35 (77)
		SB6-190	1.8 (6)	47.6	48.2	48.8	0.7	1.30 (17.7)	30		76	3	A	±5	±5	200 (125)	200 (125)	90 (198)
		SBX1-190	0.3 (1)	33.8	34.2	35.2	3.4	1.30 (17.7)	30	35	56	2	B2	±15	±20	252 (155)	320 (198)	6 (13)
	Dual	SCX2-190	0.6 (2)	38.5	39.0	39.5	1.8	1.38 (16.0)	30	35	68	3	A	±15	±20	180 (112)	252 (155)	9 (20)
		SCX3-190	0.9 (3)	42.8	43.3	43.8	1.1	1.38 (16.0)	30	35	71	3	A	±15	±15	164 (102)	252 (155)	18 (40)
		SBX4-190	1.2 (4)	44.2	44.7	45.2	1.0	1.30 (17.7)	30	35	72	3	A	±5	±15	200 (125)	200 (125)	35 (77)
		SBX6-190	1.8 (6)	47.6	48.2	48.8	0.7	1.30 (17.7)	30	35	76	3	A	±5	±5	200 (125)	200 (125)	90 (198)
		SBX6-190	1.8 (6)	47.6	48.2	48.8	0.7	1.30 (17.7)	30	35	76	3	A	±5	±5	200 (125)	200 (125)	90 (198)
		SBX6-190	1.8 (6)	47.6	48.2	48.8	0.7	1.30 (17.7)	30	35	76	3	A	±5	±5	200 (125)	200 (125)	90 (198)
21.2 to 23.6	Single	SB1-220	0.3 (1)	35.5	35.8	36.2	2.7	1.30 (17.7)	30		61	3	A	±15	±20	252 (155)	320 (198)	6 (13)
		SC2-220	0.6 (2)	40.5	41.0	41.5	1.5	1.29 (18.0)	30		66	3	A	±15	±20	180 (112)	252 (155)	9 (20)
		SC3-220	0.9 (3)	44.1	44.8	45.0	1.0	1.29 (18.0)	30		71	3	A	±15	±15	140 (87)	252 (155)	18 (40)
		SB4-220	1.2 (4)	45.5	46.1	46.6	0.8	1.30 (17.7)	30		74	3	A	±5	±15	200 (125)	200 (125)	35 (77)
		SB6-220	1.8 (6)	49.3	50.0	50.5	0.5	1.30 (17.7)	30		75	3	A	±5	±5	200 (125)	200 (125)	90 (198)
		SBX1-220	0.3 (1)	35.5	35.8	36.2	2.7	1.30 (17.7)	30	35	61	3	A	±15	±20	252 (155)	320 (198)	6 (13)
	Dual	SCX2-220	0.6 (2)	40.5	41.0	41.5	1.5	1.29 (18.0)	30									

Performance specifications

Frequency (GHz)	Polarization	Model Number	Diameter m (ft)	Gain (dBi)			3 dB-BW (deg)	VSWR/R L (dB)	X-Pol (dB)	IPI (dB)	F/B (dB)	ETSI RPE class	US FCC 101 Cat	Fine Adjust.		Windspeed km/h (mph)		Net weight kg (lb)
				Low	Mid	High								Az	Elev	Operational	Survival	
27.5 to 29.5	Single	SB1-280	0.3 (1)	37.7	37.9	38.5	2.2	1.30 (17.7)	30		63	3		±15	±20	252 (155)	320 (198)	6 (13)
		SC2-280	0.6 (2)	42.7	43.0	43.4	1.2	1.29 (18.0)	30		70	3		±15	±20	180 (112)	252 (155)	9 (20)
	Dual	SBX1-280	0.3 (1)	37.7	37.9	38.5	2.2	1.30 (17.7)	30	35	63	3		±15	±20	252 (155)	320 (198)	6 (13)
		SCX2-280	0.6 (2)	42.7	43.0	43.4	1.2	1.29 (18.0)	30	35	70	3		±15	±20	180 (112)	252 (155)	9 (20)
31 to 33.4	Single	SB1-320	0.3 (1)	39.2	39.5	39.7	2.1	1.30 (17.7)	30		63	3b		±15	±20	252 (155)	320 (198)	6 (13)
		SC2-320	0.6 (2)	43.8	44.2	44.4	1.0	1.29 (18.0)	30		70	3b		±15	±20	164 (102)	252 (155)	9 (20)
	Dual	SBX1-320	0.3 (1)	39.2	39.5	39.7	2.1	1.30 (17.7)	30	35	63	3b		±15	±20	252 (155)	320 (198)	6 (13)
		SCX2-320	0.6 (2)	43.8	44.2	44.4	1.0	1.29 (18.0)	30	35	70	3b		±15	±20	164 (102)	252 (155)	9 (20)
37 to 40	Single	SB1-380	0.3 (1)	40.0	40.3	40.5	1.6	1.30 (17.7)	30		65	3b	A	±15	±20	252 (155)	320 (198)	6 (13)
		SC2-380	0.6 (2)	44.8	45.4	45.8	0.8	1.29 (18.0)	30		70	3b	A	±15	±20	140 (87)	252 (155)	9 (20)
	Dual	SBX1-380	0.3 (1)	40.0	40.3	40.5	1.6	1.30 (17.7)	30	35	65	3b	A	±15	±20	252 (155)	320 (198)	6 (13)
		SCX2-380	0.6 (2)	44.8	45.4	45.8	0.8	1.29 (18.0)	30	35	70	3b	A	±15	±20	140 (87)	252 (155)	9 (20)
40.5 to 43.5	Single	SB1-420	0.3 (1)	40.8	41.3	41.6	1.4	1.30 (17.7)	30		60	3b		±15	±20	252 (155)	320 (198)	6 (13)
		SC2-420	0.6 (2)	45.5	45.8	46.1	0.7	1.29 (18.0)	30		65	3b		±15	±20	140 (87)	252 (155)	9 (20)
	Dual	SBX1-420 ³	0.3 (1)	40.8	41.3	41.6	1.4	1.30 (17.7)	30	30	60	3b		±15	±20	252 (155)	320 (198)	6 (13)
		SCX2-420 ³	0.6 (2)	45.5	45.8	46.1	0.7	1.29 (18.0)	30	30	65	3b		±15	±20	140 (87)	252 (155)	9 (20)
51.2 to 52.6	Single	SB1-520	0.3 (1)	41.7	41.8	41.9	1.2	1.30 (17.7)	30		62	3a / 2 ²		±23	±30	140 (87)	252 (155)	6 (13)

¹ A in 10.55-10.68 GHz, B in 10.7-11.7 GHz

² 3a in Vertical polar, 2 in Vertical and Horizontal polar







³ Planned for 1Q14

The windspeed performance specifications of 4 and 6 feet in this table apply to antennas categorized under "Configuration 1" in the associated wind speed and sway bar selection guide. All "Configuration 1" antennas with a survival wind speed of 200 km/h are also available in models that offer higher survival wind speed performance ("Configuration 2").

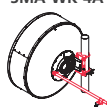
Wind speed and sway bar selection guide

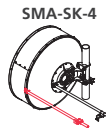
A wind kit, perimeter sway bar and sway bar connecting kit are available to complement your RFS CompactLine and CompactLine EASY antennas:

- ⊕ A wind kit increases antenna survival wind speed support from 200 km/h (125 mph) to 252 km/h (155 mph). Wind kits give customers the flexibility to upgrade survival wind speed support levels in the field during installation if wind conditions are more severe than anticipated. Note that:
 - The wind kit is available for 1.2 m (4 ft) antennas
 - 0.3 m (1 ft) have a survival wind speed of 320 km/h (198 mph)
 - 0.6 m (2 ft) and 0.9 m (3 ft) antennas have a survival wind speed of 252 km/h (155 mph)
 - 1.8 m (6 ft) antennas are available in either in 200 km/h (125 mph) or 252 km/h (155 mph) versions and cannot be upgraded in the field
- ⊕ An optional perimeter sway bar provides added assurance on antennas that are 0.9 m (3 ft) and larger in case mistakes are made during installation.
- ⊕ A universal sway bar tower connecting kit allows sway bars to be attached to pipes or L-structures without drilling a hole in the pipe or structure.

Sizes (ft)	1	2	3	4		6	
Model (Prefix)	SB/SBX	SC/SCX	SC/SCX	SB/SBX		SB/SBX	
Wind Speed (km/h)	320	252	252	Configuration 1	Configuration 2	Configuration 1	Configuration 2
				200	252*	200	252*
Sway Bar Qty	0	0	0	1	1	1	1
252 km/h Windkit	-	-	-			Not Available**	
Additional Perimeter Sway Bar	Not Available	Not Available					
Sway Bar Tower Fixation Kit	-	-					

* Order as a unique model number. For example: SB6-127AB is the standard 200 km/h (125 mph) version; SB6-127AB2 is the 252 km/h (155 mph) version. See page 20 for details.

** It is not possible to upgrade in field a SB6/SBX6 antenna from 200km/h to 252km/h.

RFS TrunkLine Class 3 (UA & UDA), Class 2 (DA & DAX) & FCC A (PAD & PADX)

For long distances and high-capacity applications

Designed for: Microwave backbone networks,
long distances, high-capacity links

Installed on: Towers

Featuring¹:

- Field-proven **reliability** and **long life**
- A choice between tested and validated ultra-high (ETSI EN 302 217 Class 3 and FCC Class A) electrical performance or high (ETSI Class 2 and FCC Class B) performance
- Support for winds up to 200 km/h (125 mph) with high-wind versions that support winds up to 252 km/h (155 mph) and an optional sway bar for added assurance in case mistakes are made during installation
- A single-piece or a split-reflector configuration² and compact packaging to reduce transportation costs
- A full line of waveguides, options and accessories

Available in:

- Frequencies ranging from 3.6 GHz to 15.35 GHz with support for two wideband frequency ranges (5.725-6.875 and 7.125-8.5) to reduce antenna requirements and simplify logistics
- Sizes ranging from 1.2 m (4 ft) to 4.6 m (15 ft)
- Single- and dual-polarized models with the ability to upgrade from single to dual polarization and change frequencies in the field in most cases³

**North America-only antennas
(PAD and PADX models) feature:**

- Improved performance that meets Federal Communications Commission (FCC) category A standards without a shroud
- Good radiation performance, particularly in the back end
- An efficient feed design and a deep-dish reflector to improve front-to-back ratio
- Support for an ultra-wideband frequency range (5.725-7.125) and two wideband frequency ranges (5.725-6.875 and 5.925-6.875)
- Antenna sizes ranging from 1.8 m (6 ft) to 3 m (10 ft)
- Single- and dual-polarized models with the ability to upgrade from single to dual polarization and change frequencies in the field in most cases³



RFS TrunkLine antennas go the distance

RFS TrunkLine antennas are proven
around the world:

- In Russia, a microwave backbone network based on RFS TrunkLine antennas provides cellular coverage along the main road and train arteries between Moscow and St. Petersburg
- In Arizona, USA, RFS TrunkLine antennas, waveguides and accessories provide the lifeline for the state's highway patrol, Emergency Medical Services (EMS) providers and other public safety services operating across long distances.

¹ These features and model ranges apply to RFS TrunkLine DA, DAX, UA and UDA antenna models. Features and models for RFS TrunkLine PAD and PADX antennas are described separately.

² The split-reflector configuration is available on antennas 2.4 m (8 ft) and larger. Single-piece is the default configuration for antennas 2.4 m (8 ft) and 3 m (10 ft). Split-reflector is the default configuration for antennas 3.7 m (12 ft) and 4.6 m (15 ft)

³ Please contact your RFS representative to verify which RFS TrunkLine antenna models support these upgrades in the field.



Antenna models

Frequency Range (GHz)	Sizes (m)	Sizes (ft)	Model Name (Single Polarized High performance)	Model Name (Single Polarized Ultra-High performance)	Model Name (Dual Polarized High performance)	Model Name (Dual Polarized Ultra-High performance)
3.6-4.2	1.8	6	DA6-36	-	DAX6-36	-
	2.4	8	DA8-36	-	DAX8-36	-
	3	10	DA10-36	-	DAX10-36	-
	3.7	12	DA12-36	-	DAX12-36	-
	4.6	15	DA15-36	-	DAX15-36	-
4.4-5	1.2	4	DA4-44	-	DAX4-44	-
	1.8	6	DA6-44	-	DAX6-44	-
	2.4	8	DA8-44	-	DAX8-44	-
	3	10	DA10-44	-	DAX10-44	-
	3.7	12	DA12-44	-	DAX12-44	-
5.725-6.875	1.8	6	PAD6-W57 ^{1,2,3}	-	-	-
	2.4	8	DA8-W57 ^{1,2}	-	-	-
			PAD8-W57 ^{1,2,3}	-	PADX8-W57 ^{1,2,3}	-
	3	10	DA10-W57 ^{1,2}	-	-	-
5.725-7.125	1.8	6	PAD10-W57 ^{1,2,3}	-	PADX10-W57 ^{1,2,3}	-
			-	-	PADX6-U57 ^{2,3}	-
			-	-	PADX8-U57 ^{2,3}	-
5.925-6.425	1.8	6	PAD6-59 ^{2,3}	UA6-59	-	-
			DA8-59	UA8-59	DAX8-59	-
	2.4	8	PAD8-59 ^{2,3}	-	-	-
			DA10-59	UA10-59	DAX10-59	-
	3.7	12	PAD10-59 ^{2,3}	-	-	-
4.6	15	DA12-59	UA12-59	DAX12-59	-	
5.925-6.875	1.8	6	DA15-59	-	DAX15-59	-
			PADX6-W59	-	-	-
			-	-	PADX8-W59 ^{1,2,3}	-
6.425-7.125	1.8	6	-	-	PADX10-W59 ^{1,2,3}	-
			PAD6-65 ^{2,3}	UA6-65	-	-
	2.4	8	DA8-65	UA8-65	DAX8-65	-
			PAD8-65 ^{2,3}	-	-	-
	3	10	DA10-65	UA10-65	DAX10-65	-
3.7	12	PAD10-65 ^{2,3}	-	-	-	
7.125-8.5	2.4	8	DA12-65	UA12-65	DAX12-65	-
			DA15-65	-	DAX15-65	-
	3	10	DA8-W71 ¹	UA8-W71 ¹	DAX8-W71 ¹	UDA8-W71 ¹
			DA10-W71 ¹	UA10-W71 ¹	DAX10-W71 ¹	UDA10-W71 ¹
3.7	12	DA12-W71 ¹	UA12-W71 ¹	DAX12-W71 ¹	UDA12-W71 ¹	
		DA15-W71 ¹	UA15-W71 ¹	DAX15-W71 ¹	UDA15-W71 ¹	
10.3-10.7	2.4	8	DA8-103	-	DAX8-103	-
	3	10	DA10-103	-	DAX10-103	-
	3.7	12	DA12-103	-	DAX12-103	-
10.7-11.7	1.8	6	PAD6-107 ^{2,3}	-	PADX6-107 ^{2,3}	-
	2.4	8	DA8-107	-	DAX8-107	-
			PAD8-107 ^{2,3}	-	PADX8-107 ^{2,3}	-
	3	10	DA10-107	-	DAX10-107	-
-			-	PADX10-107 ^{2,3}	-	
3.7	12	DA12-107	-	DAX12-107	-	
12.7-13.25	2.4	8	DA8-127	UA8-127	DAX8-127	-
	3	10	DA10-127	UA10-127	DAX10-127	-
14.2-15.35	2.4	8	DA8-142	UA8-142	DAX8-142	-

This table summarizes the main RFS TrunkLine antenna models.

Additional antenna variants and customized versions are also available.

To confirm proper ordering models, please contact your RFS representative.

¹ Wideband model

² Available only in North America

³ PAD and PADX antenna models offer improved performance

RFS PrimeLine (UXA)

Dual-polarized antennas delivering ultra-high performance and the highest XPD

Designed for: All applications that require the best RF performance, especially where interference could be an issue

Installed on: Rooftop poles or towers

Featuring:

- ⌚ Extremely high XPD for complete isolation between the radios in each polarization
- ⌚ Tested and validated ultra-high (ETSI EN 302 217 Class 3 and FCC Class A) electrical performance
- ⌚ Excellent radiation pattern envelope (RPE), particularly in the cross-polar area
- ⌚ Support for winds up to 200 km/h (125 mph) with high-wind versions that support winds up to 252 km/h (155 mph) and an optional sway bar for added assurance in case mistakes are made during installation
- ⌚ Ability to change frequencies in the field in most cases¹

Available in:

- ⌚ Frequencies ranging from 3.6 GHz to 23.6 GHz with support for two wideband frequency ranges (5.725-6.875 and 5.925-6.875) to reduce antenna requirements and simplify logistics
- ⌚ Sizes ranging from 0.6 m (2 ft) to 4.6 m (15 ft)
- ⌚ Configurations with single-piece or split reflectors; RFS recommends single-piece reflectors for optimal performance²

¹ Please contact your RFS representative to verify which RFS PrimeLine antenna models support this upgrade in the field

² Split reflectors are available on request for 2.4 m to 3.7 m (8 ft to 12 ft) antennas.

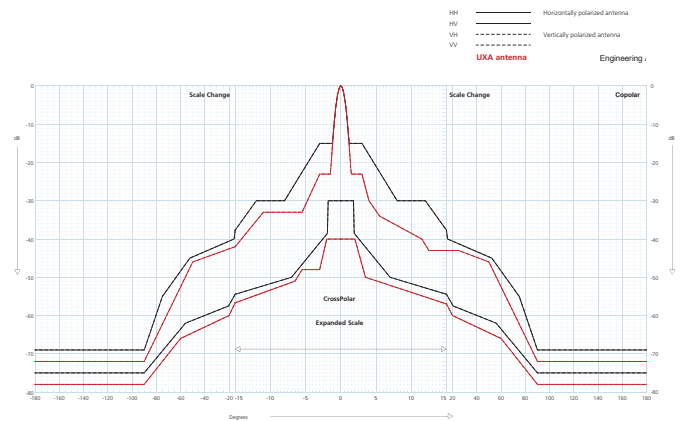

RFS PrimeLine antennas offer XPD that is typically higher than 40 dB, very low secondary lobe levels and excellent front-to-back ratios





Antenna models

Frequency Range (GHz)	Sizes (m)	Sizes (ft)	Model Name (Dual Polarized)
3.6-4.2	1.8	6	UXA6-36
	2.4	8	UXA8-36
	3	10	UXA10-36
	3.7	12	UXA12-36
	4.6	14	UXA15-36
4.4-5	1.8	6	UXA6-44
	2.4	8	UXA8-44
	3	10	UXA10-44
	3.7	12	UXA12-44
	4.6	14	UXA15-44
5.725-6.875	1.8	6	UXA6-W57 ^{1,2}
	2.4	8	UXA8-W57 ^{1,2}
	3	10	UXA10-W57 ^{1,2}
5.725-7.125	1.8	6	UXA6-U57 ²
	2.4	8	UXA8-U57 ²
	3.0	10	UXA10-U57 ²
5.925-6.425	1.2	4	UXA4-59
	1.8	6	UXA6-59
	2.4	8	UXA8-59
	3	10	UXA10-59
	3.7	12	UXA12-59
	4.6	15	UXA15-59
5.925-6.875	1.8	6	UXA6-W59 ^{1,2}
	2.4	8	UXA8-W59 ^{1,2}
	3	10	UXA10-W59 ^{1,2}
	3.7	12	UXA12-W59 ^{1,2}
6.425-7.125	1.2	4	UXA4-65
	1.8	6	UXA6-65
	2.4	8	UXA8-65
	3	10	UXA10-65
	3.7	12	UXA12-65
	4.6	15	UXA15-65
7.125-7.75	1.2	4	UXA4-71
	1.8	6	UXA6-71
	2.4	8	UXA8-71
	3	10	UXA10-71
	3.7	12	UXA12-71
	4.6	15	UXA15-71
7.725-8.5	1.2	4	UXA4-78
	1.8	6	UXA6-78
	2.4	8	UXA8-78
	3	10	UXA10-78
	3.7	12	UXA12-78
	4.6	15	UXA15-78
10.3-10.7	1.2	4	UXA4-103
	1.8	6	UXA6-103
	2.4	8	UXA8-103
	3	10	UXA10-103
	3.7	12	UXA12-103
10.5-10.7	1.2	4	UXA4-105
	1.8	6	UXA6-105
10.7-11.7	1.2	4	UXA4-107
	1.8	6	UXA6-107
	2.4	8	UXA8-107
	3	10	UXA10-107
12.7-13.25	3.7	12	UXA12-107
	1.2	4	UXA4-127
	1.8	6	UXA6-127
	2.4	8	UXA8-127
	3	10	UXA10-127
14.2-15.35	0.6	2	UXA2-142
	1.2	4	UXA4-142
	1.8	6	UXA6-142
	2.4	8	UXA8-142
17.7-19.7	0.6	2	UXA2-190
	1.2	4	UXA4-190
	1.8	6	UXA6-190
21.2-23.6	0.6	2	UXA2-220
	1.2	4	UXA4-220
	1.8	6	UXA6-220

This table summarizes the main RFS PrimeLine models.

Additional antenna variants and customized versions are also available.

For example, RFS PrimeLine antennas can be upgraded with our specialized epoxy paints and corrosion-resistant hardware so you can bring ultra-high performance and the highest XPD levels to the harshest environments. Antenna models that are designed to meet North American standards are also available.

To confirm proper ordering models, please contact your RFS representative.

¹ Wideband model
² Available only in North America

Performance specifications

Frequency (GHz)	Polarization	Model Number	Diameter m (ft)	Gain (dBi)			3 dB-BW (deg)	VSWR/R L (dB)	X-Pol (dB)	IPI (dB)	F/B (dB)	ETSI RPE class	US FCC 101 Cat	Fine Adjust.		Windspeed km/h (mph)		Net weight kg (lb)
				Low	Mid	High								Az	Elev	Operational	Survival	
12.7 to 13.25	Dual	UXA4-127	1.2 (4)	41.3	41.4	41.6	1.7	1.10 (26.4)	40	45	67	3	A	±5	±15	190 (118)	200 (125)	45 (99)
		UXA6-127	1.8 (6)	45	45.1	45.3	0.9	1.10 (26.4)	40	45	73	3	A	±5	±5	190 (118)	200 (125)	95 (209)
		UXA8-127	2.4 (8)	47.4	47.5	47.7	0.7	1.10 (26.4)	40	45	75	3	A	±5	±5	190 (118)	200 (125)	180 (396)
		UXA10-127	3.0 (10)	49.2	49.3	49.5	0.6	1.10 (26.4)	40	45	76	3	A	±5	±5	190 (118)	200 (125)	290 (638)
14.2 to 15.35	Dual	UXA2-142	0.6 (2)	36.3	36.5	36.8	2.3	1.13 (24.3)	36	40	64	3		±23	±30	190 (118)	252 (155)	15 (33)
		UXA4-142	1.2 (4)	42.3	42.5	42.8	1.2	1.10 (26.4)	36	40	70	3		±5	±15	190 (118)	200 (125)	40 (88)
		UXA6-142	1.8 (6)	45.8	46	46.3	0.8	1.10 (26.4)	38	40	75	3		±5	±5	190 (118)	200 (125)	95 (209)
		UXA8-142	2.4 (8)	48.3	48.5	48.8	0.6	1.10 (26.4)	38	40	76	3		±5	±5	190 (118)	200 (125)	180 (396)
17.7 to 19.7	Dual	UXA2-190	0.6 (2)	37.8	38.3	38.7	1.9	1.13 (24.3)	36	40	66	3	A	±23	±30	190 (118)	252 (155)	15 (33)
		UXA4-190	1.2 (4)	44	44.5	44.9	0.9	1.13 (24.3)	36	40	72	3	A	±5	±15	190 (118)	200 (125)	40 (88)
		UXA6-190	1.8 (6)	47.5	48	48.4	0.7	1.13 (24.3)	36	40	76	3	A	±5	±5	190 (118)	200 (125)	95 (209)
21.2 to 23.6	Dual	UXA2-220	0.6 (2)	39.5	40	40.5	1.6	1.15 (23.1)	36	40	66	3	A	±23	±30	190 (118)	252 (155)	15 (33)
		UXA4-220	1.2 (4)	45.5	46	46.4	0.8	1.13 (24.3)	36	40	72	3	A	±5	±15	190 (118)	200 (125)	40 (88)
		UXA6-220	1.8 (6)	49	49.5	49.9	0.5	1.13 (24.3)	36	40	76	3	A	±5	±5	190 (118)	200 (125)	95 (209)

¹ 1.5 @ 5.725-5.85 GHz











² 14 @ 5.725-5.85 GHz

The performance specifications in this table apply to antennas categorized under "Configuration 1" in the associated wind speed and sway bar selection guide. In most cases, "Configuration 1" antennas offer a survival wind speed of 200 km/h. However, most 200 km/h antennas (except 4.6 m (15 ft) models) are also available in models that offer higher survival wind speed performance.

Wind speed and sway bar selection guide

A wind kit, perimeter sway bar and sway bar connecting kit are available to complement your RFS PrimeLine antennas:

- ⊕ A wind kit increases antenna survival wind speed support from 200 km/h (125 mph) to 252 km/h (155 mph). Wind kits give customers the flexibility to upgrade survival wind speed support levels in the field during installation if wind conditions are more severe than anticipated.
- ⊕ An optional perimeter sway bar provides added assurance in case mistakes are made during installation
- ⊕ A universal sway bar tower connecting kit allows sway bars to be attached to pipes or L-structures without drilling a hole in the pipe or structure.

Sizes (ft)	2	4	4	6	8	10	12						
Model (Prefix)	UXA	UXA (below 10GHz)	UXA	UXA	UXA	UXA	UXA						
Wind Speed (km/h)	252	Configuration 1 200	Configuration 2 252*	Configuration 1 200	Configuration 2 252*	Configuration 1 200	Configuration 2 252*						
Sway Bar Qty	0	0	1	1	1	1	1						
252 km/h Windkit	-		-		-		-		-		-		-
Additional Perimeter Sway Bar	Not Available	Not Available											
Sway Bar Tower Fixation Kit	-												

*Order as a unique model number. For example: UXA6-65BD is the standard 200 km/h (125 mph) version; UXA6-65BD2 is the 252 km/h (155 mph) version. See page 20 for details.

RFS Harsh Areas Line

Robust antennas for the harshest environmental conditions

Designed for: Marine environments, off-shore locations, industrial and highly corrosive locations, volcanic areas, tropical climates, mountaintops with severe wind, ice and snow conditions

Installed on: Rooftop poles or towers

Featuring:

- Reflectors and shrouds painted inside and outside with a two-component epoxy paint
- Feeds painted with a two-component epoxy paint
- Mounting hardware and attachment hardware in corrosion-resistant ISO 3506 A4 (SAE 316L) steel stabilized with molybdenum
- Steel mounting with an extended galvanic layer
- Additional silicon sealant applied to screws, connectors and couplings during installation
- Factory-installed equipment to support winds up to 252 km/h (155 mph)
- A single-piece reflector to ensure all antenna surfaces are treated and protected
- A flexible radome that is designed to avoid snow accumulation¹

Available in:

- Frequencies ranging from 3.6 GHz to 26.5 GHz with support for a wideband frequency range (7.125-8.5) to reduce antenna requirements and simplify logistics
- Sizes ranging from 0.6 m (2 ft) to 3.7 m (12 ft)
- Single- and dual-polarized models with the ability to upgrade from single to dual polarization and change frequencies in the field²

¹ Provided on all RFS Harsh Areas Line antennas 1.2 m (4 ft) and larger.

² Please contact your RFS representative to verify which RFS Harsh Areas Line antenna models support these upgrades in the field.



RFS Harsh Areas Line antennas help Pioneer Cellular maintain communications after a severe ice storm in Oklahoma, United States

Despite the damage they sustained, the RFS microwave antenna systems that comprise approximately 98 percent of the 200-hop microwave backhaul network remained functional.



Antenna models

Frequency Range (GHz)	Sizes (m)	Sizes (ft)	Model Name (Single Polarized)	Model Name (Dual Polarized)
3.6-4.2	2.4	8	DA8-36**2H	DAX8-36**2H
	3	10	DA10-36**2H	DAX10-36**2H
	3.7	12	DA12-36**5H	DAX12-36**5H
4.4-5	2.4	8	DA8-44**2H	DAX8-44**2H
	3	10	DA10-44**2H	DAX10-44**2H
	3.7	12	DA12-44**5H	DAX12-44**5H
5.925-6.425	1.2	4	SU4-59**2H	SUX4-59**2H
	1.8	6	SU6-59**2H	SUX6-59**2H
	2.4	8	DA8-59**2H	DAX8-59**2H
	3	10	DA10-59**2H	DAX10-59**2H
	3.7	12	DA12-59**5H	DAX12-59**5H
6.425-7.125	1.2	4	SU4-65**2H	SUX4-65**2H
	1.8	6	SU6-65**2H	SUX6-65**2H
	2.4	8	DA8-65**2H	DAX8-65**2H
	3	10	DA10-65**2H	DAX10-65**2H
	3.7	12	DA12-65**5H	DAX12-65**5H
7.125-8.5	0.6	2	SU2-W71**2H ¹	-
	1.2	4	SU4-W71**2H ¹	SUX4-W71**2H ¹
	1.8	6	SU6-W71**2H ¹	SUX6-W71**2H ¹
	2.4	8	DA8-W71**2H ¹	DAX8-W71**2H ¹
	3	10	DA10-W71**2H ¹	DAX10-W71**2H ¹
	3.7	12	DA12-W71**5H ¹	DAX12-W71**5H ¹
10.3-10.7	0.6	2	SU2-103**2H	-
	1.2	4	SU4-103**2H	SUX4-103**2H
	1.8	6	SU6-103**2H	SUX6-103**2H
	2.4	8	DA8-103**2H	DAX8-103**2H
	3	10	DA10-103**2H	DAX10-103**2H
	3.7	12	DA12-103**5H	DAX12-103**5H
10.7-11.7	0.6	2	SU2-107**2H	-
	1.2	4	SU4-107**2H	SUX4-107**2H
	1.8	6	SU6-107**2H	SUX6-107**2H
	2.4	8	DA8-107**2H	DAX8-107**2H
	3	10	DA10-107**2H	DAX10-107**2H
	3.7	12	DA12-107**2H	DAX12-107**5H
12.7-13.25	0.6	2	SU2-127**2H	SUX2-127**2H
	1.2	4	SU4-127**2H	SUX4-127**2H
	1.8	6	SU6-127**2H	SUX6-127**2H
	2.4	8	DA8-127**2H	DAX8-127**2H
	3	10	DA10-127**2H	DAX10-127**2H
14.2-15.35	0.6	2	SU2-142**2H	SUX2-142**2H
	1.2	4	SU4-142**2H	SUX4-142**2H
	1.8	6	SU6-142**2H	SUX6-142**2H
	2.4	8	DA8-142**2H	DAX8-142**2H
17.7-19.7	0.6	2	SU2-190**2H	SUX2-190**2H
	1.2	4	SU4-190**2H	SUX4-190**2H
	1.8	6	SU6-190**2H	SUX6-190**2H
21.2-23.6	0.6	2	SU2-220**2H	SUX2-220**2H
	1.2	4	SU4-220**2H	SUX4-220**2H
	1.8	6	SU6-220**2H	SUX6-220**2H
24.25-26.5	0.6	2	SU2-250**2H	SUX2-250**2H
	1.2	4	SU4-250**2H	SUX4-250**2H

This table summarizes the main RFS Harsh Areas Line antenna models.

Additional antenna variants and customized versions are also available. For example:

- RFS PrimeLine antenna models can be upgraded with our specialized epoxy paints and corrosion-resistant hardware so you can bring ultra-high performance and the highest XPD levels to the harshest environments.
- RFS can develop customized Harsh Areas Line antennas to meet requirements for specific projects or specific wind, humidity, ice, snow, volcanic ash or pollution challenges. An antenna ice shield is also available in North America.

** : these 2 digits indicates the antenna revision index and the flange option – see the RFS naming structure in page 20 for more details.

To confirm proper ordering models, please contact your RFS representative.

¹ Wideband model

Performance specifications

Frequency (GHz)	Polarization	Model Number	Diameter m (ft)	Gain (dBi)			3 dB-BW (deg)	VSWR/R L (dB)	X-Pol (dB)	IPI (dB)	F/B (dB)	ETSI RPE class	US FCC 101 Cat	Fine Adjust.		Windspeed km/h (mph)		Net weight kg (lb)	
				Low	Mid	High								Az	Elev	Operational	Survival		
12.7 to 13.25	Single	SU2-127***2H	0.6 (2)	35.2	35.4	35.6	2.7	1.20 (20.8)	32		62	3		±23	±30	190 (118)	252 (155)	15 (33)	
		SU4-127***2H	1.2 (4)	41.3	41.5	41.7	1.4	1.20 (20.8)	32		67	3	B	±5	±15	190 (118)	252 (155)	45 (99)	
		SU6-127***2H	1.8 (6)	44.9	45.1	45.3	0.9	1.20 (20.8)	32		72	3	A	±5	±5	190 (118)	252 (155)	115 (254)	
		DA8-127***2H	2.4 (8)	47.6	47.7	47.9	0.7	1.08 (28.3)	30		71	2	A	±5	±5	190 (118)	252 (155)	190 (419)	
		DA10-127***2H	3 (10)	49.4	49.5	49.7	0.6	1.08 (28.3)	30		71	2	A	±5	±5	190 (118)	252 (155)	320 (706)	
	Dual	SUX2-127***2H	0.6 (2)	35.1	35.3	35.5	2.7	1.25 19.1	32	35	65	3		±23	±30	190 (118)	252 (155)	15 (33)	
		SUX4-127***2H	1.2 (4)	41.3	41.5	41.7	1.4	1.25 19.1	32	35	67	3	B	±5	±15	190 (118)	252 (155)	45 (99)	
		SUX6-127***2H	1.8 (6)	44.8	45.0	45.2	0.9	1.25 19.1	32	35	72	3	A	±5	±5	190 (118)	252 (155)	115 (254)	
		DAX8-127***2H	2.4 (8)	47.4	47.5	47.7	0.7	1.10 26.4	30	35	70	2	A	±5	±5	190 (118)	252 (155)	190 (419)	
		DAX10-127***2H	3 (10)	49.2	49.3	49.5	0.6	1.10 26.4	30	35	71	2	A	±5	±5	190 (118)	252 (155)	320 (706)	
14.2 to 15.35	Single	SU2-142***2H	0.6 (2)	36.2	36.5	36.8	2.3	1.20 (20.8)	32		62	2		±23	±30	190 (118)	252 (155)	15 (33)	
		SU4-142***2H	1.2 (4)	42.2	42.5	42.8	1.2	1.20 (20.8)	32		70	2		±5	±15	190 (118)	252 (155)	45 (99)	
		SU6-142***2H	1.8 (6)	45.7	46	46.3	0.8	1.20 (20.8)	32		73	2		±5	±5	190 (118)	252 (155)	115 (254)	
		DA8-142***2H	2.4 (8)	48.3	48.5	48.8	0.6	1.10 (26.4)	30		70	1		±5	±5	190 (118)	252 (155)	190 (419)	
	Dual	SUX2-142***2H	0.6 (2)	36.2	36.5	36.8	2.3	1.20 (20.8)	32	35	62	2		±23	±30	190 (118)	252 (155)	15 (33)	
		SUX4-142***2H	1.2 (4)	42.1	42.4	42.7	1.2	1.20 (20.8)	32	35	70	2		±5	±15	190 (118)	252 (155)	45 (99)	
		SUX6-142***2H	1.8 (6)	45.6	45.9	46.2	0.8	1.20 (20.8)	32	35	74	2		±5	±5	190 (118)	252 (155)	115 (254)	
		DAX8-142***2H	2.4 (8)	48.3	48.5	48.8	0.6	1.10 (26.4)	30	35	69	1		±5	±5	190 (118)	252 (155)	190 (419)	
17.7 to 19.7	Single	SU2-190***2H	0.6 (2)	41.6	42.1	42.6	1.3	1.20 (20.8)	32		63	2	A	±23	±30	190 (118)	252 (155)	15 (33)	
		SU4-190***2H	1.2 (4)	44.1	44.6	45.1	0.9	1.20 (20.8)	32		71	2	A	±5	±15	190 (118)	252 (155)	45 (99)	
		SU6-190***2H	1.8 (6)	47.5	48	48.5	0.7	1.20 (20.8)	32		75	2	A	±5	±5	190 (118)	252 (155)	115 (254)	
	Dual	SUX2-190***2H	0.6 (2)	41.6	42.1	42.6	1.3	1.20 (20.8)	32	35	63	2	A	±23	±30	190 (118)	252 (155)	15 (33)	
		SUX4-190***2H	1.2 (4)	44.0	44.5	45.0	0.9	1.20 (20.8)	32	35	67	2	A	±5	±15	190 (118)	252 (155)	45 (99)	
		SUX6-190***2H	1.8 (6)	47.4	47.9	48.4	0.7	1.20 (20.8)	32	35	76	2	A	±5	±5	190 (118)	252 (155)	115 (254)	
21.2 to 23.6	Single	SU2-220***2H	0.6 (2)	39.5	40	40.5	1.6	1.25 (19.1)	32		66	2	A	±23	±30	190 (118)	252 (155)	15 (33)	
		SU4-220***2H	1.2 (4)	45.6	46.1	46.6	0.8	1.20 (20.8)	32		72	3	A	±5	±15	190 (118)	252 (155)	45 (99)	
		SU6-220***2H	1.8 (6)	49	49.5	50	0.5	1.20 (20.8)	32		75	2	A	±5	±5	190 (118)	252 (155)	115 (254)	
	Dual	SUX2-220***2H	0.6 (2)	39.5	40	40.5	1.6	1.25 (19.1)	32	35	66	2	A	±23	±30	190 (118)	252 (155)	15 (33)	
		SUX4-220***2H	1.2 (4)	45.6	46.1	46.6	0.8	1.20 (20.8)	32	35	72	3	A	±5	±15	190 (118)	252 (155)	45 (99)	
		SUX6-220***2H	1.8 (6)	49	49.5	50	0.5	1.20 (20.8)	32	35	75	2	A	±5	±5	190 (118)	252 (155)	115 (254)	
24.25 to 26.5	Single	SU2-250***2H	0.6 (2)	40.5	40.8	41.3	1.4	1.25 (19.1)	32		67	2	B	±23	±30	190 (118)	252 (155)	15 (33)	
		SU4-250***2H	1.2 (4)	46.8	47.2	47.6	0.7	1.20 (20.8)	32		73	3	A	±5	±15	190 (118)	252 (155)	45 (99)	
	Dual	SUX2-250***2H	0.6 (2)	40.5	40.8	41.3	1.4	1.25 (19.1)	32	35	67	2	B	±23	±30	190 (118)	252 (155)	15 (33)	
		SUX4-250***2H	1.2 (4)	46.7	47.1	47.5	0.7	1.25 (19.1)	32	35	73	3	A	±5	±15	190 (118)	252 (155)	45 (99)	



** : these 2 digits indicate the antenna revision index and the flange option – see the RFS naming structure on page 20 for more details.

Wind speed and sway bar selection guide

A perimeter sway bar and sway bar connecting kit are available to complement your RFS Harsh Areas Line antennas:

⊕ An optional perimeter sway bar provides added assurance in case mistakes are made during installation

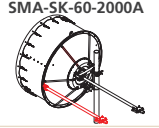
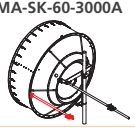
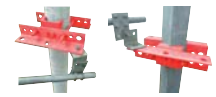
⊕ A universal sway bar tower connecting kit allows sway bars to be attached to pipes or L-structures without drilling a hold in the pipe or structure.

Sizes (ft)	2	4	4	6	8	10	12
Model (Prefix)	SU/SUX	SUX (below 10 GHz)	SU/SUX	SU/SUX	DA/DAX	DA/DAX	DA/DAX
Wind Speed (km/h)	252	252	252	252	252	252	252
Sway Bar Qty	0	1	1	1	1	1	1
Additional Perimeter Sway Bar	Not Available	Not Available					
Sway Bar Tower Fixation Kit							

Glossary

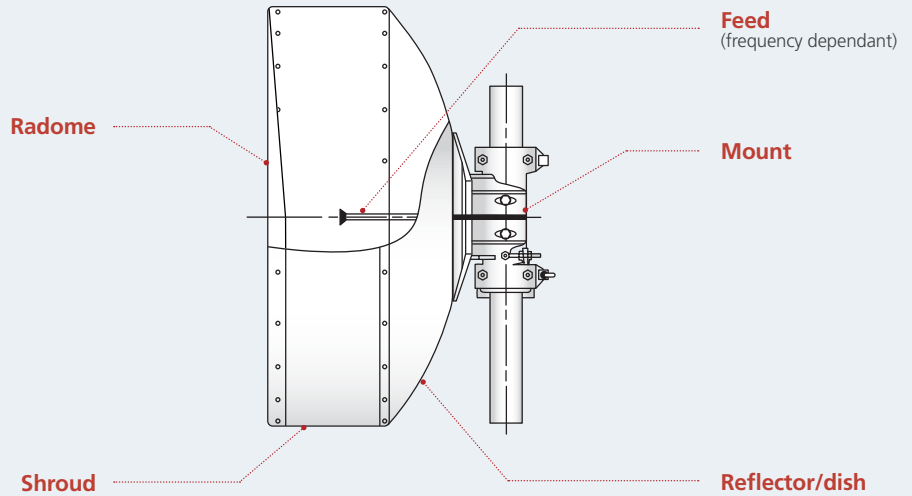

Gain

The ratio of the radiation intensity in the main beam axis to the radiation intensity that would be obtained if the power accepted by the antenna were radiated isotropically. Value measured in dBi. The values are stated for the three frequencies at mid-band as well as for the bottom and top of the frequency band. The tolerance for antenna gain is ± 0.5 dB.

Half power beam width (3 dB-BW)

The angle, relative to the main beam axis, between the two directions at which the co-polar pattern is 3 dB below the value on the main beam axis.

Voltage standing wave ratio (VSWR) or return loss

The voltage standing wave ratio, or return loss, characterizes the level of energy reflected by impedance mismatching along an electrical transmission line. Expressed in dB, the return loss is a logarithmic measure of the reflection coefficient. It represents the ratio of the transmitted power to the reflected power.

The stated values are guaranteed across the frequency band of operation.

Radiation pattern envelope (RPE)

The envelope represents the worst values of measurements taken on the pattern test range at the three frequencies that are mid-band, bottom and top of band, in copolar and cross-polar conditions, horizontal and vertical polarized, over the full 360° of azimuth.

Since the envelope is drawn over the highest peaks of all measurements, actual interference radiation in an operational system will generally be smaller than calculated from the RPE. Tolerance on given values is 3 dB in an angular region of $\pm 100^\circ$ and 2 dB from 100° to 180° .

Front-to-back ratio (F/B)

The highest level of radiation relative to the main beam in an angular zone of $180^\circ \pm 40^\circ$ for all antennas. Tolerance on stated values is 2 dB.

Cross polarization discrimination (XPD)

The difference in dB between the co-polarized main beam gain and the orthogonal signal measured within an angular zone of azimuth that is twice the maximum half power beam width of the frequency band.

Inter-port isolation (IPI)

The ratio in dB of the power level applied to one input port of a dual-polarized antenna to the power level received in the other input port on the same antenna.

Operational wind speed

The antenna axis deflection is less than one-third of the half power beam width at the highest frequency supported. The drop in signal is only approximately 1 dB; the radio link will therefore continue to operate.

Survival wind speed

The antenna sub-system will survive the specified survival wind speed without any permanent deformation or changes of shape, although realignment might be needed. An additional load of a 25 mm (1 in) radial ice layer is taken into account.

Mechanical, environmental and electrical testing

All RFS microwave antennas undergo extensive mechanical, environmental and radio-electrical tests during development to ensure they meet or exceed specifications.

Mechanical tests include:

Shock and vibration tests



Mechanical and static wind load tests



Wind tunnel tests

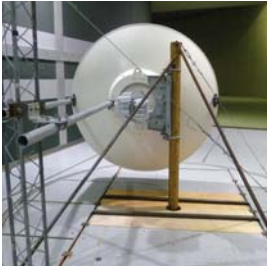

Packing tests

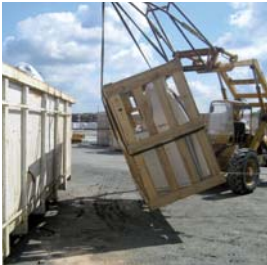

Environmental tests include:

Corrosion tests

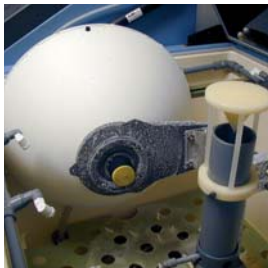

Temperature tests



Humidity tests



Rain tests



Radio-electrical tests include:

Far field radiation measurement (co-polar and cross-polar) tests

Test range for small antennas



Test range for large antennas



Return loss / VSWR measurement tests



¹ All radio-electrical tests are performed on all antenna sizes (up to or 4.6 m or 15 ft) and frequencies (up to 80 GHz).

Understanding RFS model names



All RFS model names are based on a naming structure that tells you*:

The antenna family to which they belong The antenna diameter The antenna frequency range The antenna mechanical options The antenna color



UA	8	-	W71	A	C	1 ¹	S ¹	1 ¹	T ¹
ANTENNA FAMILY	DIAMETER		FREQUENCY RANGE GHz	ANTENNA REVISION	FLANGE OPTIONS	MECHANICAL OPTIONS	ENVIRONMENT OPTIONS	COLOR OPTIONS*	RADOME OPTIONS
SB Single polarized CompactLine®	05² 0.5 ft (0.15m)	23	2.3-2.5	A 1 st revision	B PBR flange	1 Survival Wind speed 200 km/h, standard reflector condition • From 1 ft to 10 ft: reflector is non-split • 12 ft: reflector is split (except UXA type which is non split) • 15 ft: reflector is split (including UXA) <i>This digit is omitted in the model name when no other specific option is needed.</i>	S Standard Environment Corresponds to the most common configurations. <i>This digit is therefore omitted in the model name when no other specific option is needed.</i>	1 Natural White (Standard) <i>Corresponds to the RFS standard configuration. Other options are available upon request.</i>	T Teflon Radome
SBX Dual polarized CompactLine®	1 1 ft (0.3 m)	34	3.4-3.9	B 2 nd revision	C CPR flange				R Rigid radome for standard performance antenna only
SC Single polarized CompactLine Easy	2 2 ft (0.6 m)	36	3.6-4.2	C 3 rd revision	D PDR flange				L No logo on radome
SCX Dual polarized CompactLine Easy	3 3 ft (0.9 m)	44	4.4-5		J N-male connector with Jumper				
DA Single polarized High Performance	4 4 ft (1.2 m)	52	5.25-5.85		N N-female connector	2 Survival Wind speed 250 km/h, standard reflector condition		D Dark Grey (RAL 7030)	
DAX Dual polarized High Performance	6 6 ft (1.8 m)	W57	5.725-6.875		U UG-flange	4 Survival Wind speed 200 km/h, non standard reflector condition • From 8 ft to 10 ft: reflector is split • 12 ft: reflector is non split (except UXA type which is split)	H Harsh Environment	G Grey (RAL7000)	
UA Single polarized Ultra High Performance	8 8 ft (2.4 m)	U57	5.725-7.125		V UDR-flange	5 Survival Wind speed 250 km/h, non standard reflector condition	Q Northern Climate (High Wind/High Ice)	L Light Grey (RAL 7035)	
UDA Dual polarized Ultra High Performance	10 10 ft (3 m)	59	5.925-6.425		W UBR-flange	7 Survival Wind speed 200 km/h, standard reflector and extra sway bar at the rim		O Olive Green (RAL 6003)	
PAD ³ Single polarized improved performance	12 12 ft (3.7 m)	W59	5.925-6.875		X PBR 260-flange in 250 band/ Flange R84 on frequency 71	8 Survival Wind speed 250 km/h, standard reflector and extra sway bar at the rim			
PADX ³ Dual polarized improved performance	15 15 ft (4.6 m)	W60	5.925-7.125		Z Choke-flange	B Installation on pipe diameter 219 mm			
UXA Dual polarized Ultra High performance with High Cross Polarization Discrimination		65	6.425-7.125			Q Survival wind speed 250km/h and installation on pipe diameter 219mm			
SU Single polarized SlimLine® Ultra High Performance		71	7.125-7.75			R Class 1 antenna (200 km/h +25mm ice or 180 km/h +55 mm ice) applicable on specific antenna			
SUX Dual polarized SlimLine® Ultra High Performance		71	7.125-8.5			S Class 2 antenna (250 km/h +25mm ice or 225 km/h +55 mm ice) applicable on specific antenna			
LA Single polarized Lens antenna		78	7.725-8.5			T Survival Wind speed 200 km/h, standard reflector and 2 extra sway bars at the rim applicable on specific antenna			
SPF Single polarized Slimline® Standard performance Non pressurized		W100	10-11.7			U Survival Wind speed 250 km/h, standard reflector and 2 extra sway bars at the rim applicable on specific antenna			
		101	10.1-10.7						
		100	10-10.7						
		103	10.3-10.7						
		105	10.5-10.7						
		107	10.7-11.7						
		127	12.7-13.25						
		142	14.2-15.35						
		190	17.7-19.7						
		220	21.2-23.6						
		250	24.25-26.5						
		280	27.5-29.5						
		320	31-33.4						
		380	37-40						
		420	40.2-43.5						
		520	51.4-52.6						
		W800	71-86						

FEED HORN RECTANGULAR WAVEGUIDE SIZE		
Frequency	IEC	EIA
36	R40	WR-229
44	R48	WR-187
W57	R70	WR-137
U57	R70	WR-137
59	R70	WR-137
W59	R70	WR-137
W60	R70	WR-137
65	R70	WR-137
71**	R70	WR-137
W71	R84	WR-112
78	R84	WR-112
W100	R100	WR-90
101	R100	WR-90
100	R100	WR-90
103	R100	WR-90
105	R100	WR-90
107	R100	WR-90
127	R120	WR-75
142	R140	WR-62
190	R220	WR-42
220	R220	WR-42
250***	R220	WR-42
280	R320	WR-28
320	R320	WR-28
380	R320	WR-28
420	R500	WR-19

* Antenna versions that support specific vendor radios are not shown in this table

Some options might not be available on all antennas – please refer to RFS for specific requests

¹ Digits are omitted when options are not present

² Lens antenna only

³ Specific to North America

⁴ Other color options are available upon request

** 71 is available with R84/WR-112 as option

***250 is available with PBR260 as option

Why RFS?



RFS has been a leader in designing and manufacturing microwave antennas for more than 30 years and has deployed several million microwave antennas around the globe. With manufacturing facilities on five continents, RFS can ensure its customers enjoy low transportation costs and short lead times.

Here are just a few of the reasons customers choose RFS microwave antennas

- ⊕ **Innovative structural designs** minimize materials without sacrificing mechanical stability.
 - Lightweight, yet robust antennas reduce tower loading as well as installation costs and time.
- ⊕ **Mechanical designs are based on advanced calculation methods**, such as the finite element method.
 - Mechanical stability and higher wind resistance reduce maintenance requirements and increase antenna life span.
- ⊕ **A spun backing design** on antenna dishes 1.8 m (6 ft) and larger increases mechanical stability and link security.
- ⊕ **Rear-mounted feeds** on most models simplify installation.
- ⊕ **Small antennas meet key radiation pattern requirements.**
 - Smaller antennas can be used in place of larger antennas to simplify site negotiations and minimize leasing costs.
- ⊕ **Modular designs, low maintenance requirements and long-term reliability** reduce total cost of ownership.
- ⊕ **Compact packaging** reduces transportation requirements and simplifies logistics.
- ⊕ **Very simple installation procedures** accelerate installations and reduce training requirements.
- ⊕ **Optional split-reflector designs** further reduce packaging and transportation requirements.
- ⊕ **Customized fittings** allow specific radios and hot-standby couplers to be mounted directly on the antenna, eliminating the need for a waveguide link to the radio¹.
- ⊕ **Extensive testing and qualification procedures** mean there are no compromises in performance or safety. Our customers have complete confidence in our microwave antennas.

¹ RFS CompactLine and CompactLine EASY antennas support integrated radios.

**For more information, please contact
the nearest RFS sales office:**

Southern Europe, Middle East, Africa & India

www.rfsworld.com/sales/semesai

Northern Europe

www.rfsworld.com/sales/euno

Latin America

www.rfsworld.com/sales/latam

North America

www.rfsworld.com/sales/na

Asia Pacific

www.rfsworld.com/sales/apac

www.rfsworld.com

RADIO FREQUENCY SYSTEMS
The Clear Choice®

