

MaxGard®

DuraGard®

ABB IEC



Choose Thomas & Betts and connect to the power you need.

For over 100 years, Thomas & Betts has successfully applied innovative design and manufacturing techniques to meet the changing needs of the marketplace. Today, we offer more than 100,000 electrical components and systems to terminate, connect, fasten, protect and identify wires, components and raceway. Our vast offering makes us one of the largest and best sources of electrical components in North America.

At T&B, we're committed to:

- Products which provide solutions to your electrical needs
- Convenience of single-order, single-shipment to your site for thousands of stocking items
- Expert local point of contact for clear, consistent information regarding training, codes and standards
- Quality brands that have proven themselves over time
- Inventive design and manufacture of problem-solving products
- Offering a best-of-class warranty and returns policy
- Uniform carton labeling with additional bar-coding for convenient inventory management
- Nationwide network of stocking electrical distributors
- Outstanding customer service capability
- Supplying you with the right products, convenient packaging, on-time delivery and competitive pricing

We deliver the solutions that make your job easier and offer the power to bring it all together in one package. Call us today and let us help you profit from sourcing your electrical products from the leader, Thomas & Betts.



Healthcare



Wastewater Treatment



Food and Beverage



Oil and Gas



Customer Service

1-800-816-7809

Immediate, Knowledgeable Assistance

Every Thomas & Betts Customer Service Representative is right where the action is — surrounded by all the support and information they need to answer your questions and fill your orders faster than ever. Your calls and faxes are automatically routed to Customer Service Specialists who personally serve your account and can answer questions about products, order status, price and availability, and other service-related inquiries.

Phone: 1-800-816-7809

Fax: 1-800-816-7810

Email: generalcustomerserviceteam@tnb.com



T&B Access®

tnbaccess.tnb.com

T&B Access® is a global sales tool for our distributor partners, offering:

- Quote Requests
- Stock Checks
- Pricing Inquiries
- Cross Reference
- Order Entry
- Order Resolution
- Shipping Status
- Document Look-Up
- Automatic Order Receiving
- Item History Search
- Multiple-Location User Search
- Context-Sensitive Help
- Shipping Confirmations
- Tracking Data
- Expediting
- Returns Processing
- Quality Issues
- Customer Report Cards
- Web Catalog Look-Up

All of these tools and more are available online 24 hours a day – 7 days a week, without having to make a single phone call. Multi-lingual options are available in English, French and Spanish. T&B Access® now serves over 10,000 satisfied customer users at over 3,500 locations every month.

Contents

T&B Services	1-3
The Russellstoll® Advantage	4-6
MaxGard®	
Interconnection Systems	7-49
GSUL Safe Ground Indicator System	50-52
DuraGard® Waterproof Connections	53-70
ABB IEC 60 309 International Pin and Sleeve	71-85



Thomas & Betts

A Member of the ABB Group

www.tnb.com

T&B Services

Technical Services

1-888-862-3289

Over 170 Years of Industry Experience

Meeting and exceeding our customers' expectations is a fundamental goal of Thomas & Betts. Call our Technical Services Department and talk LIVE to an expert who'll answer questions and concerns regarding all aspects of our products and services. Our experienced and knowledgeable staff is second to none in the industry!



Tool Services

1-800-284-TOOL

Quality You Can Trust

Trust T&B's dedicated Tool Services Department to answer all questions regarding tool applications, repair, warranties, sales/lease/rental and technical information. Ask about our specialized services, including customer/sales training, demos and calibration/certification of tools.

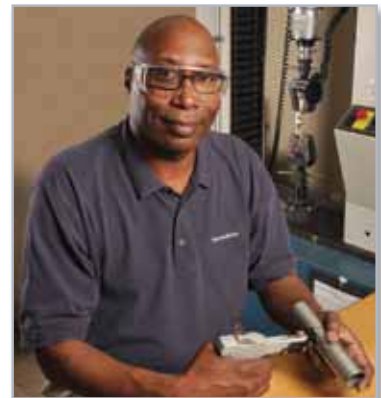

Web Catalog

www.tnb.com/webcatalog

Thousands of Products at Your Fingertips

U.S. contractors and specifiers have made our web catalog their number one stop. Users can search for technical information by catalog number, UPC code, competitor number, keyword search, product category and/or brand. Having found the item(s) they are searching for, they can then use our **Where To Buy** function to locate a T&B local distributor and/or other support services.



T&B Services

Web CAD Library

www.tnb.com/CADLibrary

Over 4,000 2D and 3D CAD Models Available FREE!

The T&B CAD Library is an on-line source of 2D and 3D CAD models, available FREE to customers who register. Users can download these files to their desktops for import into their working drawings. Drawings are offered in 90 of the most popular native file formats. This is a valuable tool for CAD designers, OEMs and engineering firms, as it will allow them to quickly locate and download T&B drawings into their projects. Over 4,000 drawings of T&B® Fittings, PMA® Cable Protection, Kindorf®, Red•Dot® and Superstrut® products and Steel City® and Carlon® Floor Boxes are currently available, and we're continually adding more products to the library.



BIM Library

Now available to you through Autodesk® Seek (**seek.autodesk.com**), our BIM (Building Information Modeling) objects can easily be imported to your Revit® models. These BIM objects are fully standards compliant, Revit® Certified and completely configurable.

Autodesk and Revit are registered trademarks of Autodesk, Inc.

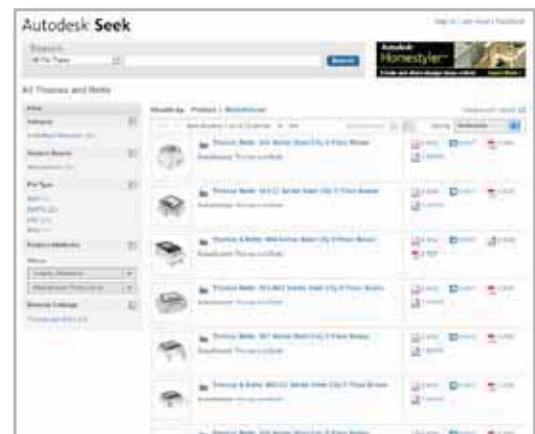

The Russellstoll® Advantage

Count on Better Safety, Durability and Performance

Russellstoll® Pin and Sleeve Power Connectors

Safety	
	
SAFETY	LIQUID INGRESS PROTECTION
<p>The high-performance designs of Russellstoll® interconnection systems exceed UL® and IEC 60 309 ratings. Through superior engineering, special material selection and patented design features, Russellstoll has maintained global leadership in the industry for more than 30 years.</p>	<p>Russellstoll helps protect electrical systems against short circuits in wet conditions. Design features such as mating screw collars, O-ring sealed pin and sleeves and Neoprene O-ringed interior components prevent liquid ingress, resulting in prolonged system life and higher operational reliability.</p>

Durability

CORROSION RESISTANCE
<p>Through the use of durable brass pins, stainless steel hardware and components and highly corrosion-resistant materials such as PBT and double electrostatic powder coating on housings, Russellstoll interconnection systems help prevent costly downtime due to corrosion.</p>

The Russellstoll® Advantage

Durability



RELIABILITY AND POWER QUALITY

Russellstoll® is designed to be one of the longest lasting interconnection systems in the market. Large circular electrical contacts enhance current flow by reducing the contact temperature, and IEC 60 309 products use glass-reinforced nylon materials for contact inlets, minimizing the need for replacement parts.

Performance



CONTINUOUS OPERATION

Russellstoll maximizes uptime in critical power areas like food and beverage and data centers through design features such as self-cleaning pin configurations and corrosion-resistant double steel screws in the terminals that promote sustainability.



SUSTAINABILITY

Well-designed product features combined with decades of experience in the industry enable Russellstoll interconnection systems to ensure the highest sustainability through safety, durability and performance.

The Russellstoll® Advantage

Russellstoll® interconnection systems has added ABB IEC Industrial Pin and Sleeve to its product line to enhance the Thomas & Betts industrial interconnect selection. The consolidation of these industry-leading interconnection systems creates one of the market's most comprehensive offerings of explosion-proof, heavy- and light-industrial plugs, sockets, connectors and receptacles, which range from 20 to 600 amps.



MaxGard® — Heavy Industrial Applications

Harsh environments and extreme conditions such as explosion-proof areas, high-corrosion atmospheres and rugged terrain

Applications:

- Mining
- Oil & Gas
- Heavy Marine
- Welding Equipment
- Industrial OEMs



MaxGard®

DuraGard® — Light Industrial Applications

Waterproof (1000-PSI water test)

Areas where there are size constraints, chemicals, moisture, high water pressure and the need for waterproof rather than water-resistant protection

Applications:

- Data Centers
- Food & Beverage
- Shore-to-Ship Power
- Portable Power
- Distribution Equipment Manufacturers
- Industrial OEMs



DuraGard®

ABB IEC 60 309 — Light Industrial Applications

International IEC 60 309 — IP67 Watertight

Situations that require international interchangeability, watertight construction and corrosion and chemical resistance

Applications:

- Data Centers
- Food & Beverage
- Shore-to-Ship Power
- Portable Power
- Distribution Equipment Manufacturers
- Industrial OEMs



ABB

MaxGard® Interconnection Systems

In this section...



MaxGard® Interconnection Systems

Overview	8-12
Competitive Checklist and Catalog Numbering System.....	13
Load-Breaking Plugs, Receptacles and Connectors — 30 Amp.....	14-17
Load-Breaking Plugs, Receptacles and Connectors — 60 Amp.....	18-21
Load-Breaking Plugs, Receptacles and Connectors — 100 Amp.....	22-25
Load-Breaking Plugs, Receptacles and Connectors — 200 Amp.....	26-29
Load-Breaking Plugs, Receptacles and Connectors — 400 Amp.....	30-33
Accessories	34-37
Engineering Specifications	38-39
Voltage Selector.....	40
Dimensions.....	41-42
Industrial Interlocked Receptacles.....	43-49
GSUL Safe Ground Indicator System	50-52

Thomas & Betts

A Member of the ABB Group

MaxGard® Interconnection Systems

30A–400A (30–200A Load Breaking), Maximum 600VAC/250VDC
Receptacles, Inlets, Plugs, Connectors, Interlocked Receptacles, Explosion-Proof Interlocked Receptacles



Safety

- **Different power supply ratings can't mix:** 24 single-rate device polarizations ensure exact voltage, frequency and phase differentiation
- **Safe connections:** Safely connect and disconnect, even in the most extreme conditions such as heavy industrial and explosion-proof environments
- **Added safety measures:** Explosion-proof rating on all plugs
- **Plugs stay in:** Standard delayed-action pull-and-turn withdrawal offers all plugs an explosion-proof rating
- **Waterproof construction:** Standard O-ringed interior components provide environmental separation; watertight mated or unmated

Durability

- **Built for durability:** Rugged cast aluminum housings with an electrostatic epoxy coating are standard, along with stainless steel hardware
- **The best connections for life:** Pins and sleeves are made from Marine-grade CDA 485 brass; 200- and 400-amp pins and sleeves are silver plated

Performance

- **Foreign objects stay out:** All receptacles and connectors have a gated rotating disk (gated deadfront) on the face of the interior, which engages upon insertion
- **Any configuration you need:** Through 4-pole 5-wire configurations, all have a safety center earth ground pin design that makes first and breaks last
- **Ease of assembly:** Solderless pressure-type screw terminals with hex socket heads and rear-access, take-apart housings provide quick wiring access — no interior removal required for wiring receptacles and connectors
- **More control available:** Two optional pilot/control pins for contactors, load monitoring circuit, shunt trip or any other communication function you need
- **More power:** 150% non UL® rating enables MaxGard® installations to be extended up to 600-amp custom loads with separate disconnect service

MaxGard® Interconnection Systems

30A–400A (30–200A Load Breaking), Maximum 600VAC/250VDC Receptacles, Inlets, Plugs, Connectors, Interlocked Receptacles, Explosion-Proof Interlocked Receptacles

Plug and Receptacle with Angle Adapter and Junction Box

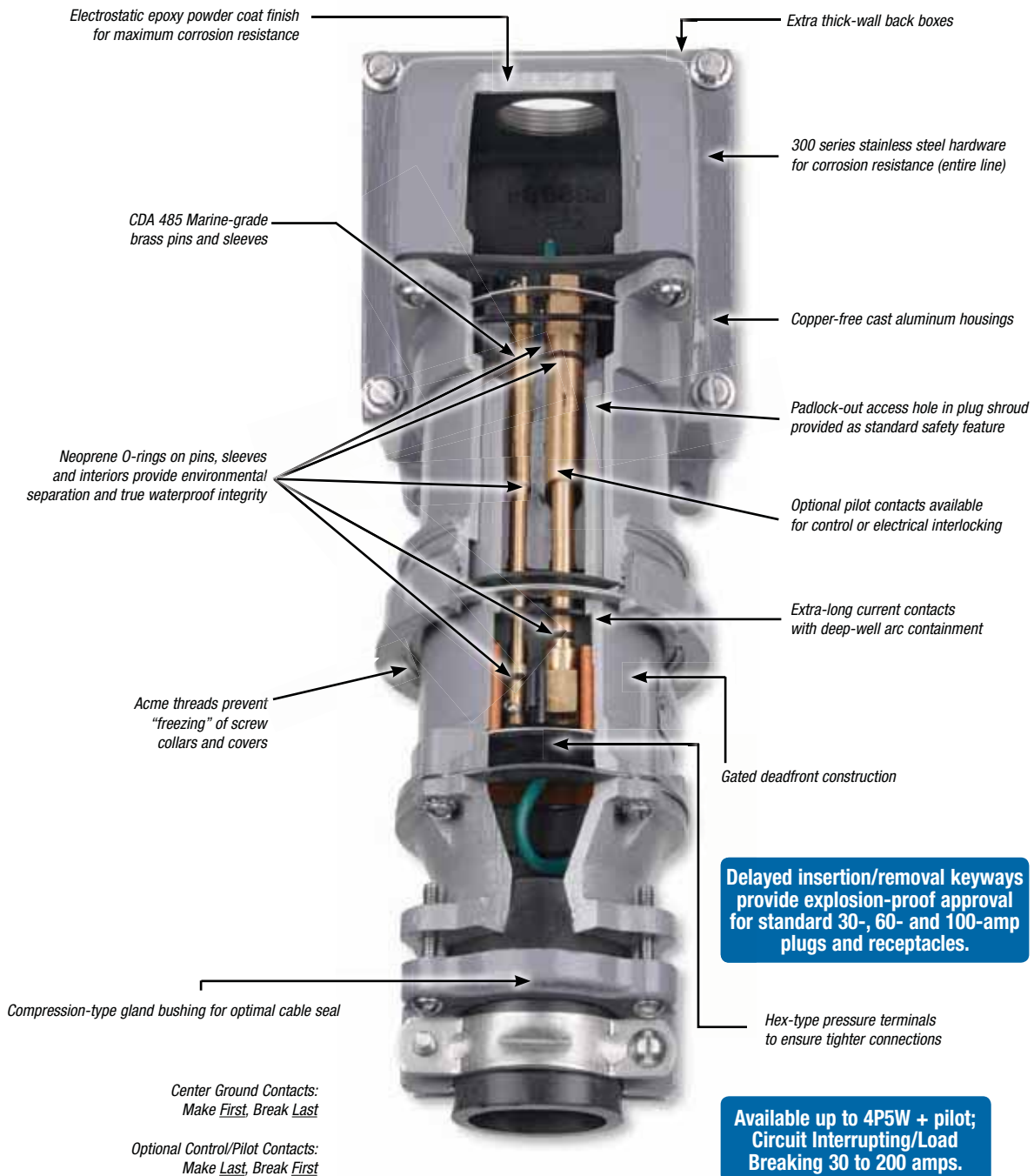

Russellstoll® Pin and Sleeve Power Connectors

MaxGard® Interconnection Systems

30A–400A (30–200A Load Breaking), Maximum 600VAC/250VDC Receptacles, Inlets, Plugs, Connectors, Interlocked Receptacles, Explosion-Proof Interlocked Receptacles

Cast Aluminum Circuit Breaker Interlocked Receptacle (Cutaway View)

Russellstoll® Pin and Sleeve Power Connectors

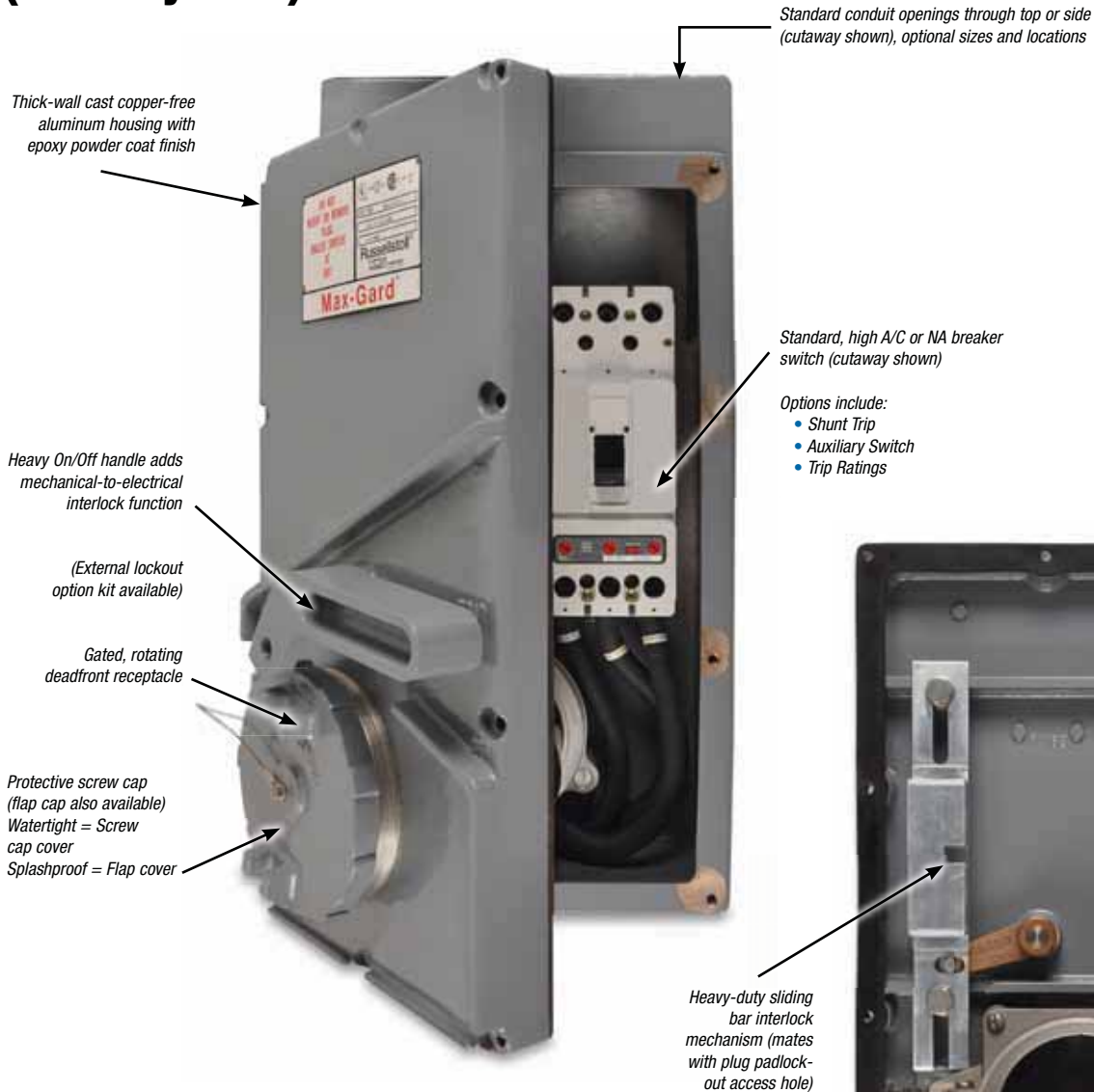

NEMA 4X interlocks available in 30–400-amp ranges through 4P5W, with 2 optional pilot/control contacts.

MaxGard® Interconnection Systems

30A–400A (30–200A Load Breaking), Maximum 600VAC/250VDC
 Receptacles, Inlets, Plugs, Connectors, Interlocked Receptacles, Explosion-Proof Interlocked Receptacles

Fused-Disconnect Switch* Interlocked Receptacle

Available in 30-, 60- and 100-amp sizes, all polarizations through 600VAC.

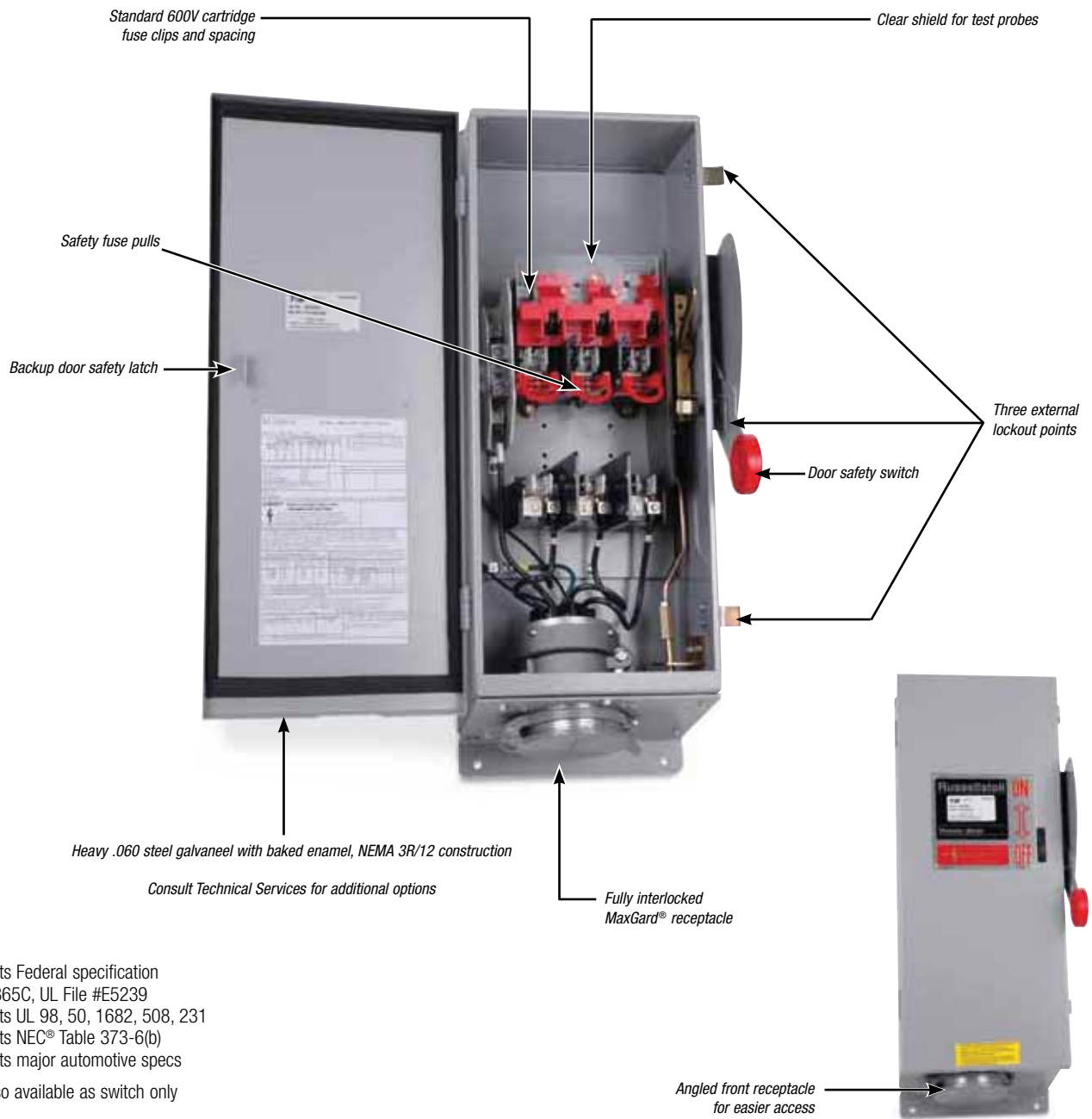

Meets Federal specification
 WS865C, UL File #E5239
 Meets UL 98, 50, 1682, 508, 231
 Meets NEC® Table 373-6(b)
 Meets major automotive specs

* Also available as switch only

Russellstoll® Pin and Sleeve Power Connectors

MaxGard® Interconnection Systems

30A–400A (30–200A Load Breaking), Maximum 600VAC/250VDC
 Receptacles, Inlets, Plugs, Connectors, Interlocked Receptacles, Explosion-Proof Interlocked Receptacles

MaxGard® DBRE and DSRE series interlocks are explosion proof and waterproof (O-ring sealed), along with optional control contacts, and are fully UL® Listed.

Explosion-Proof Waterproof Circuit Breaker Interlocked Receptacle

Available in 30-, 60- and 100-amp sizes, all polarizations.

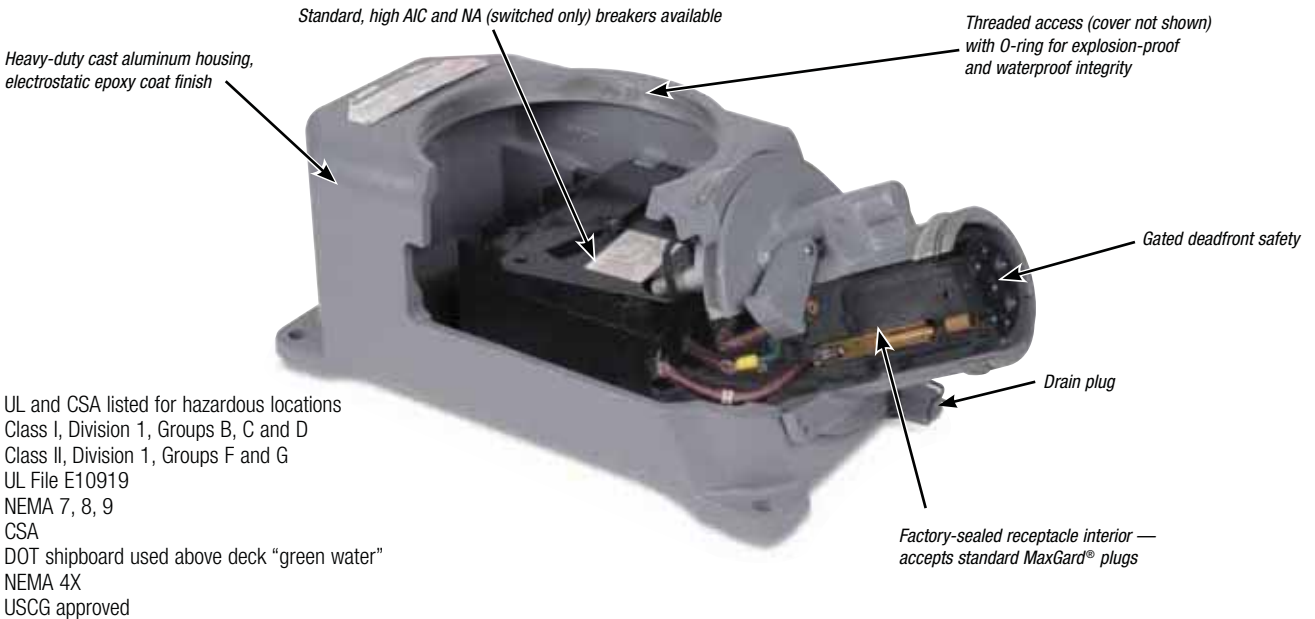

UL and CSA listed for hazardous locations
 Class I, Division 1, Groups B, C and D
 Class II, Division 1, Groups F and G
 UL File E10919
 NEMA 7, 8, 9
 CSA
 DOT shipboard used above deck "green water"
 NEMA 4X
 USCG approved

Explosion-Proof Waterproof Non-Interlocked Receptacle

Available in 30A 480VAC max, all polarizations

- Factory-sealed interior (no filled conduits)
- Easy low-cost installation



UL and CSA Listed for hazardous locations
 Class I, Division 1, C and D
 Class II, Division 1, Groups F and G
 UL File E10919
 NEMA 7, 8, 9
 CSA
 DOT shipboard used above deck "green water"
 NEMA 4X
 USCG approved

MaxGard® Interconnection Systems

30A–400A Plugs, Connectors, Receptacles, Inlets and Interlocked Receptacles

Receptacles, Plugs and Connectors

FEATURE	RUSSELLSTOLL MAXGARD®	CROUSE-HINDS ARKTITE®**	APPLETON POWERTITE®***
Center ground contact	Yes	No	No
24 single-rated factory polarizations	Yes	No	No
Gated deadfront construction	Yes	No	No
Two optional control contacts	Yes	No	No
Marine-grade CDA485 brass pins/sleeves (200–400 amp silver-plated)	Yes	No	No
O-rings/environmental separation, full line	Yes	No	No
Available to 5-wire (4-pole, 5-wire)	Yes	30 and 60 amp only	No
Complete line epoxy powder coated — standard	Yes	No	Some

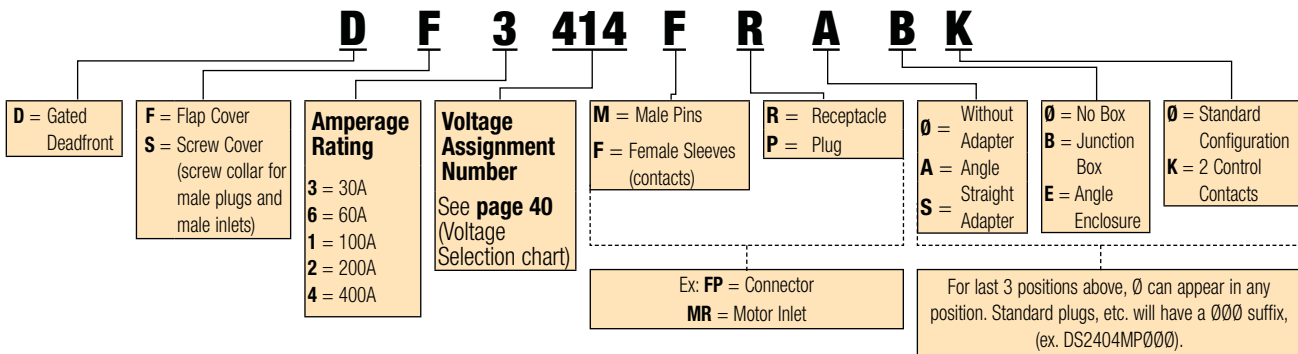

Interlocked Receptacles

FEATURE	RUSSELLSTOLL DBRE/DSRE SERIES	CROUSE-HINDS EPC SERIES	APPLETON EBR SERIES (WITH FB BREAKER)
Waterproof (DurORing™) O-ring sealing	Yes	No	No
Available to 5-wire (4-pole, 5-wire) through 100 amp	Yes	No	No
Gated deadfront	Yes	No	No
Center ground sleeve contact	Yes	No	No
24 single-rated factory polarizations	Yes	No	No
Class I, Div. 1, Groups B, C, D	Yes	Yes	Yes
Class II, Div. 1, Groups F and G	Yes	Yes	Yes*
Meets Coast Guard (was CG259) approvals	Yes	No	No

* Group F excepting electrically conductive dusts. ** Crouse-Hinds and Arktite are trademarks of Cooper Industries, Inc. *** Appleton and Powertite are trademarks of Appleton Electric Inc.

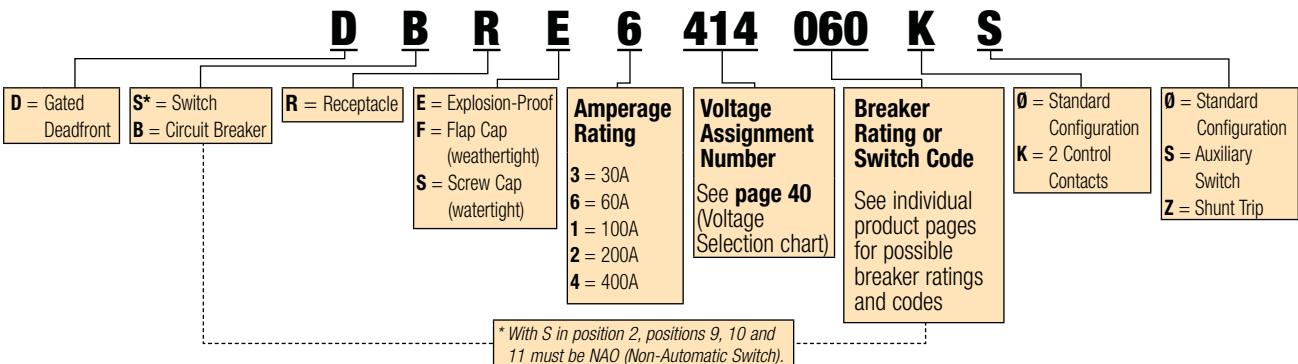

MaxGard® Interconnection Systems

30 Amp Standard Service

** If receptacle is desired with a Straight Adapter instead of standard Angle Adapter, substitute "S" for the "A" in the catalog number of the Receptacle with Angle Adapter or Adapter and Box.

† Standard cable bushings shown; see **page 34** for other sizes available at no extra cost if specified on order.

†† Always furnished with screw collar. We recommend cup cap with male plug; order catalog number DS3CC.

Maximum lug wire 8 AWG 7-strand or flexible, cable entrance .187" diameter.

Receptacles furnished with flap cap also have screw thread to accept male collar on plug.

Catalog numbers shown are for flap cap receptacles; change "DF" to "DS" for ordering screw cap.

Boldface figures are for voltage assignment.

For different ratings, see **page 40**.

Outlet furnished at location "B" unless otherwise specified. 1" NPT.

▼ **Control contacts for plug/receptacles:**
Use "K" where noted. Ex: DS3104MP00K

For Adapters, Junction Boxes and Accessories, see **pages 34–37**.

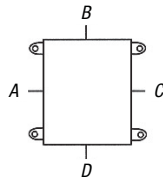

Male Plug††

Female Connector

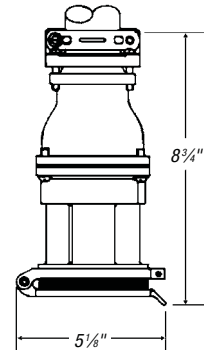
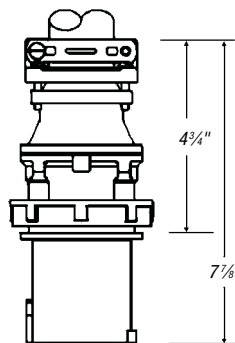

Device Ratings and Polarizations

Maximum 600VAC or 250VDC

(For full polarization, see **page 40**)

POLE	WIRE	CONDUCTOR PLACEMENT	VOLTAGE 60 HZ	CAT. NO.	STANDARD BUSHING I.D.†	CAT. NO.	STANDARD BUSHING I.D.†
2	3		277	DS3104MP000	7/8"	DF3104FP000	7/8"
			125	DS3107MP000		DF3107FP000	
2	3		480	DS3204MP000	7/8"	DF3204FP000	7/8"
			250	DS3207MP000		DF3207FP000	
			600	DS3214MP000		DF3214FP000	
			208	DS3216MP000		DF3216FP000	
3	4		277/480	DS3304MP000	1"	DF3304FP000	1"
			125/250	DS3307MP000		DF3307FP000	
			120/208	DS3316MP000		DF3316FP000	
3	4		3Ø 480	DS3404MP000	1"	DF3404FP000	1"
			3Ø 250	DS3407MP000		DF3407FP000	
			3Ø 600	DS3414MP000		DF3414FP000	
			3Ø 208	DS3416MP000		DF3416FP000	
			3Ø 440	DS3421MP000		DF3421FP000	
4	5		3ØY 277/480	DS3504MP000	1 1/16"	DF3504FP000	1 1/16"
			3ØY 347/600	DS3514MP000		DF3514FP000	
			3ØY 120/208	DS3516MP000		DF3516FP000	
			3ØY 250/440	DS3521MP000		DF3521FP000	

MaxGard® Interconnection Systems



Female Receptacle with Angle Enclosure



Female Receptacle with Angle Adapter** and Junction Box



Female Receptacle with Angle Adapter**



Female Receptacle

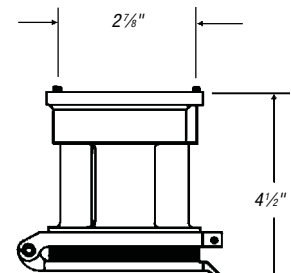
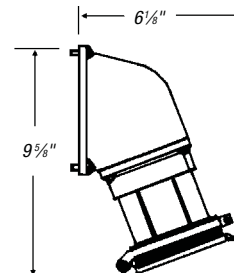
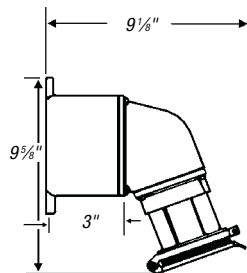
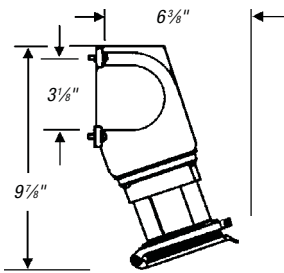

CAT. NO.	CAT. NO.	CAT. NO.	CAT. NO.
DF3104FR0E0	DF3104FRAB0	DF3104FRA00	DF3104FR000
DF3107FR0E0	DF3107FRAB0	DF3107FRA00	DF3107FR000
DF3204FR0E0	DF3204FRAB0	DF3204FRA00	DF3204FR000
DF3207FR0E0	DF3207FRAB0	DF3207FRA00	DF3207FR000
DF3214FR0E0	DF3214FRAB0	DF3214FRA00	DF3214FR000
DF3216FR0E0	DF3216FRAB0	DF3216FRA00	DF3216FR000
DF3304FR0E0	DF3304FRAB0	DF3304FRA00	DF3304FR000
DF3307FR0E0	DF3307FRAB0	DF3307FRA00	DF3307FR000
DF3316FR0E0	DF3316FRAB0	DF3316FRA00	DF3316FR000
DF3404FR0E0	DF3404FRAB0	DF3404FRA00	DF3404FR000
DF3407FR0E0	DF3407FRAB0	DF3407FRA00	DF3407FR000
DF3414FR0E0	DF3414FRAB0	DF3414FRA00	DF3414FR000
DF3416FR0E0	DF3416FRAB0	DF3416FRA00	DF3416FR000
DF3421FR0E0	DF3421MRAB0	DF3421FRA00	DF3421FR000
DF3504FR0E0	DF3504FRAB0	DF3504FRA00	DF3504FR000
DF3514FR0E0	DF3514FRAB0	DF3514FRA00	DF3514FR000
DF3516FR0E0	DF3516FRAB0	DF3516FRA00	DF3516FR000
DF3521FR0E0	DF3521FRAB0	DF3521FRA00	DF3521FR000

MaxGard® Interconnection Systems

30 Amp Reverse Service

** If receptacle is desired with a Straight Adapter instead of standard Angle Adapter, substitute "S" for the "A" in the catalog number of the Receptacle with Angle Adapter or Adapter and Box.

† Standard cable bushings shown; see **page 34** for other sizes available at no extra cost if specified on order.

†† Always furnished with screw collar. We recommend cup cap with male plug; order catalog number DS3CC.

Maximum lug wire 4 AWG 7-strand or flexible, cable entrance .187" diameter.

Receptacles furnished with flap cap also have screw thread to accept male collar on plug.

Catalog numbers shown are for flap cap receptacles; change "DF" to "DS" for ordering screw cap.

Boldface figures are for voltage assignment. For different ratings, see **page 40**.

Outlet furnished at location "B" unless otherwise specified. 1" NPT.

▼ **Control contacts for plug/receptacles:**
Use "K" where noted. Ex: DS3104MR00K

For Adapters, Junction Boxes and Accessories, see **pages 34–37**.

Device Ratings and Polarizations

Maximum 600VAC or 250VDC

(For full polarization, see **page 40**)

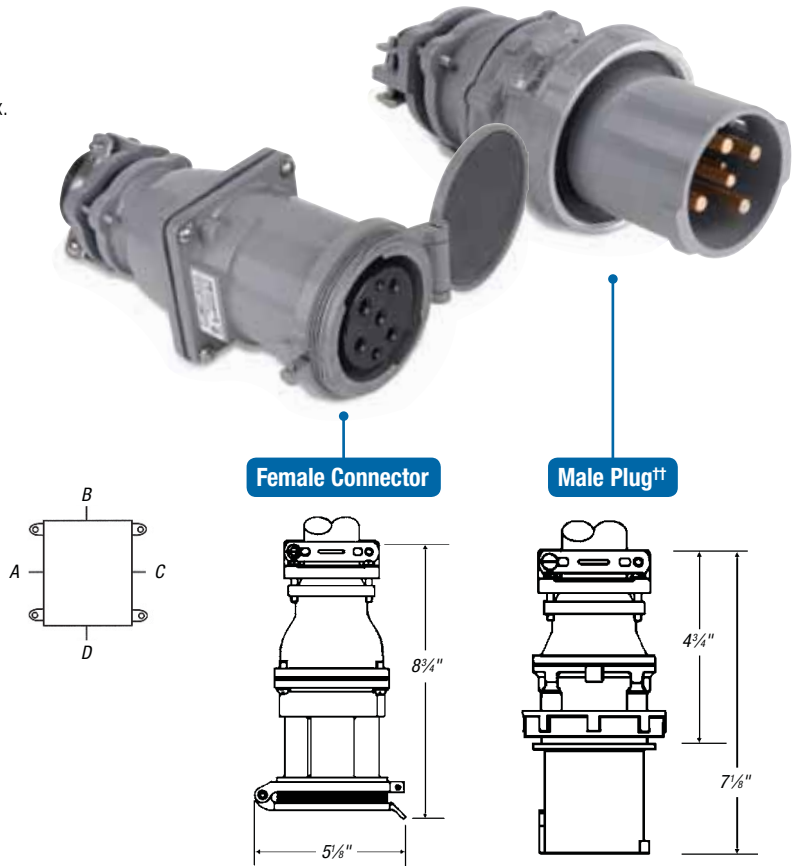

POLE	WIRE	CONDUCTOR PLACEMENT	VOLTAGE 60 HZ	CAT. NO.	STANDARD BUSHING I.D.†	CAT. NO.	STANDARD BUSHING I.D.†
2	3		277	DF3104FP000	7/8"	DS3104MP000	7/8"
			125	DF3107FP000		DS3107MP000	
2	3		480	DF3204FP000	7/8"	DS3204MP000	7/8"
			250	DF3207FP000		DS3207MP000	
			600	DF3214FP000		DS3214MP000	
			208	DF3216FP000		DS3216MP000	
3	4		277/480	DF3304FP000	1"	DS3304MP000	1"
			125/250	DF3307FP000		DS3307MP000	
			120/208	DF3316FP000		DS3316MP000	
3	4		3Ø 480	DF3404FP000	1"	DS3404MP000	1"
			3Ø 250	DF3407FP000		DS3407MP000	
			3Ø 600	DF3414FP000		DS3414MP000	
			3Ø 208	DF3416FP000		DS3416MP000	
			3Ø 440	DF3421FP000		DS3421MP000	
4	5		3ØY 277/480	DF3504FP000	1 1/16"	DS3504MP000	1 1/16"
			3ØY 347/600	DF3514FP000		DS3514MP000	
			3ØY 120/208	DF3516FP000		DS3516MP000	
			3ØY 250/440	DF3521FP000		DS3521MP000	

MaxGard® Interconnection Systems

Russellstoll® Pin and Sleeve Power Connectors



Male Inlet with Angle Enclosure



Male Inlet with Angle Adapter** and Junction Box



Male Inlet with Angle Adapter**



Male Inlet††

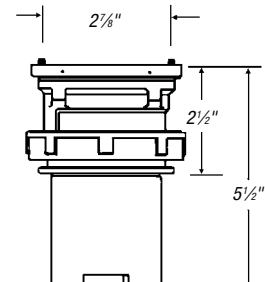
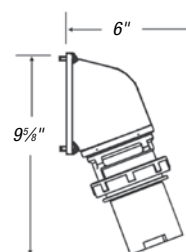
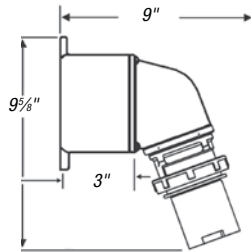
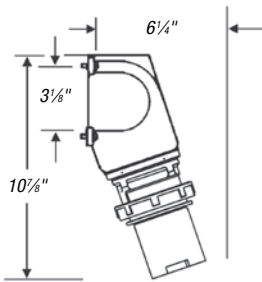

CAT. NO.	CAT. NO.	CAT. NO.	CAT. NO.
DS3104MR0E0	DS3104MRAB0	DS3104MRA00	DS3104MR000
DS3107MR0E0	DS3107MRAB0	DS3107MRA00	DS3107MR000
DS3204MR0E0	DS3204MRAB0	DS3204MRA00	DS3204MR000
DS3207MR0E0	DS3207MRAB0	DS3207MRA00	DS3207MR000
DS3214MR0E0	DS3214MRAB0	DS3214MRA00	DS3214MR000
DS3216MR0E0	DS3216MRAB0	DS3216MRA00	DS3216MR000
DS3304MR0E0	DS3304MRAB0	DS3304MRA00	DS3304MR000
DS3307MR0E0	DS3307MRAB0	DS3307MRA00	DS3307MR000
DS3316MR0E0	DS3316MRAB0	DS3316MRA00	DS3316MR000
DS3404MR0E0	DS3404MRAB0	DS3404MRA00	DS3404MR000
DS3407MR0E0	DS3407MRAB0	DS3407MRA00	DS3407MR000
DS3414MR0E0	DS3414MRAB0	DS3414MRA00	DS3414MR000
DS3416MR0E0	DS3416MRAB0	DS3416MRA00	DS3416MR000
DS3421MR0E0	DS3421MRAB0	DS3421MRA00	DS3421MR000
DS3504MR0E0	DS3504MRAB0	DS3504MRA00	DS3504MR000
DS3514MR0E0	DS3514MRAB0	DS3514MRA00	DS3514MR000
DS3516MR0E0	DS3516MRAB0	DS3516MRA00	DS3516MR000
DS3521MR0E0	DS3521MRAB0	DS3521MRA00	DS3521MR000

MaxGard® Interconnection Systems

60 Amp Standard Service

** If receptacle is desired with a Straight Adapter instead of standard Angle Adapter, substitute "S" for the "A" in the catalog number of the Receptacle with Angle Adapter or Adapter and Box.

† Standard cable bushings shown; see **page 34** for other sizes available at no extra cost if specified on order.

†† Always furnished with screw collar. We recommend cup cap with male plug; order catalog number DS6CC.

Maximum lug wire 4 AWG 7-strand or flexible, cable entrance .302" diameter.

Receptacles furnished with flap cap also have screw thread to accept male collar on plug.

Catalog numbers shown are for flap cap receptacles; change "DF" to "DS" for ordering screw cap.

Boldface figures are for voltage assignment. For different ratings, see **page 40**.

Outlet furnished at location "B" unless otherwise specified. 1½" NPT.

▼ **Control contacts for plug/receptacles:**
Use "K" where noted. Ex: DS6104MP00K

For Adapters, Junction Boxes and Accessories, see **pages 34–37**.

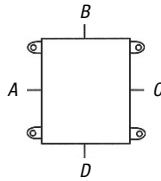

Male Plug††

Female Connector

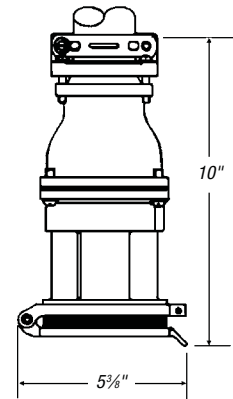
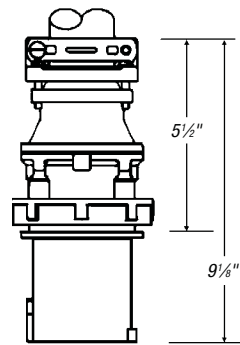

Device Ratings and Polarizations

Maximum 600VAC or 250VDC

(For full polarization, see **page 40**)

POLE	WIRE	CONDUCTOR PLACEMENT	VOLTAGE 60 HZ	CAT. NO.	STANDARD BUSHING I.D. †	CAT. NO.	STANDARD BUSHING I.D. †
2	3		277	DS6104MP000	1 3/16"	DF6104FP000	1 3/16"
			125	DS6107MP000		DF6107FP000	
2	3		480	DS6204MP000	1 3/16"	DF6204FP000	1 3/16"
			250	DS6207MP000		DF6207FP000	
			600	DS6214MP000		DF6214FP000	
			208	DS6216MP000		DF6216FP000	
3	4		277/480	DS6304MP000	1 3/16"	DF6304FP000	1 3/16"
			125/250	DS6307MP000		DF6307FP000	
			120/208	DS6316MP000		DF6316FP000	
3	4		3Ø 480	DS6404MP000	1 3/16"	DF6404FP000	1 3/16"
			3Ø 250	DS6407MP000		DF6407FP000	
			3Ø 600	DS6414MP000		DF6414FP000	
			3Ø 208	DS6416MP000		DF6416FP000	
			3Ø 440	DS6421MP000		DF6421FP000	
4	5		3ØY 277/480	DS6504MP000	1 1/2"	DF6504FP000	1 1/2"
			3ØY 347/600	DS6514MP000		DF6514FP000	
			3ØY 110/208	DS6516MP000		DF6516FP000	
			3ØY 250/440	DS6521MP000		DF6521FP000	

MaxGard® Interconnection Systems



Female Receptacle with Angle Enclosure

Female Receptacle with Angle Adapter and Junction Box**

Female Receptacle with Angle Adapter**

Female Receptacle

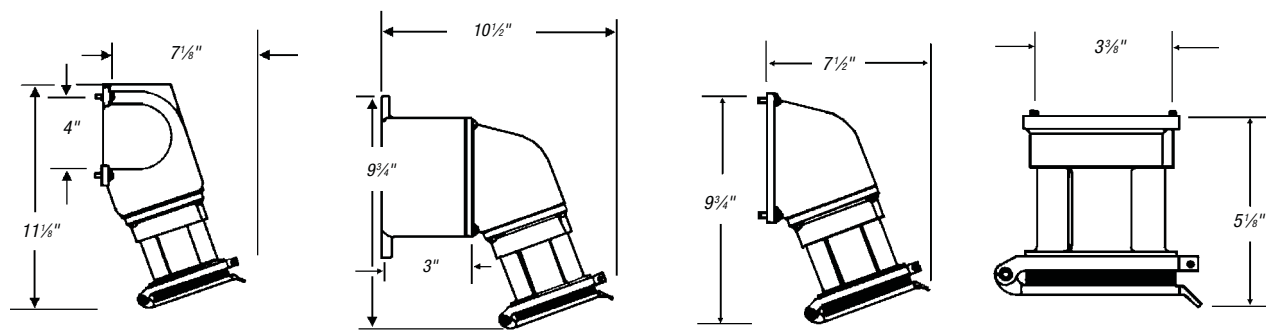

CAT. NO.	CAT. NO.	CAT. NO.	CAT. NO.
DF6104FR0E0	DF6104FRAB0	DF6104FRA00	DF6104FR000
DF6107FR0E0	DF6107FRAB0	DF6107FRA00	DF6107FR000
DF6204FR0E0	DF6204FRAB0	DF6204FRA00	DF6204FR000
DF6207FR0E0	DF6207FRAB0	DF6207FRA00	DF6207FR000
DF6214FR0E0	DF6214FRAB0	DF6214FRA00	DF6214FR000
DF6216FR0E0	DF6216FRAB0	DF6216FRA00	DF6216FR000
DF6304FR0E0	DF6304FRAB0	DF6304FRA00	DF6304FR000
DF6307FR0E0	DF6307FRAB0	DF6307FRA00	DF6307FR000
DF6316FR0E0	DF6316FRAB0	DF6316FRA00	DF6316FR000
DF6404FR0E0	DF6404FRAB0	DF6404FRA00	DF6404FR000
DF6407FR0E0	DF6407FRAB0	DF6407FRA00	DF6407FR000
DF6414FR0E0	DF6414FRAB0	DF6414FRA00	DF6414FR000
DF6416FR0E0	DF6416FRAB0	DF6416FRA00	DF6416FR000
DF6421FR0E0	DF6421FRAB0	DF6421FRA00	DF6421FR000
DF6504FR0E0	DF6504FRAB0	DF6504FRA00	DF6504FR000
DF6514FR0E0	DF6514FRAB0	DF6514FRA00	DF6514FR000
DF6516FR0E0	DF6516FRAB0	DF6516FRA00	DF6516FR000
DF6521FR0E0	DF6521FRAB0	DF6521FRA00	DF6521FR000

MaxGard® Interconnection Systems

60 Amp Reverse Service

** If receptacle is desired with a Straight Adapter instead of standard Angle Adapter, substitute "S" for the "A" in the catalog number of the Receptacle with Angle Adapter or Adapter and Box.

† Standard cable bushings shown; see **page 34** for other sizes available at no extra cost if specified on order.

†† Always furnished with screw collar. We recommend cup cap with male plug; order catalog number DS6CC.

Maximum lug wire 4 AWG 7-strand or flexible, cable entrance .302" diameter.

Receptacles furnished with flap cap also have screw thread to accept male collar on plug.

Catalog numbers shown are for flap cap receptacles; change "DF" to "DS" for ordering screw cap.

Boldface figures are for voltage assignment.

For different ratings, see **page 40**.

Outlet furnished at location "B" unless otherwise specified. 1½" NPT.

▼ **Control contacts for plug/receptacles:**
Use "K" where noted. Ex: **DS3104MP00K**

For Adapters, Junction Boxes and Accessories, see **pages 34–37**.

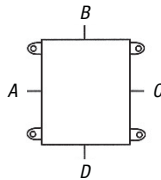

Female Connector

Male Plug††

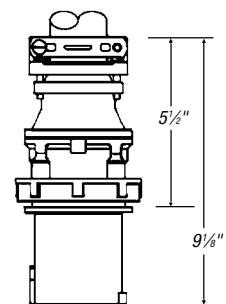
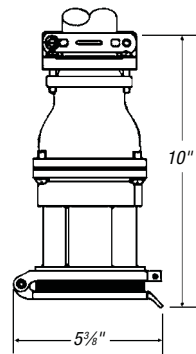

Device Ratings and Polarizations

Maximum 600VAC or 250VDC

(For full polarization, see **page 40**)

POLE	WIRE	CONDUCTOR PLACEMENT	VOLTAGE 60 HZ	CAT. NO.	STANDARD BUSHING I.D.†	CAT. NO.	STANDARD BUSHING I.D.†
2	3		277	DF6104FP000	1 3/16"	DS6104MP000	1 3/16"
			125	DF6107FP000		DS6107MP000	
2	3		480	DF6204FP000	1 3/16"	DS6204MP000	1 3/16"
			250	DF6207FP000		DS6207MP000	
			600	DF6214FP000		DS6214MP000	
			208	DF6216FP000		DS6216MP000	
3	4		277/480	DF6304FP000	1 3/16"	DS6304MP000	1 3/16"
			125/250	DF6307FP000		DS6307MP000	
			120/208	DF6316FP000		DS6316MP000	
3	4		3Ø 480	DF6404FP000	1 3/16"	DS6404MP000	1 3/16"
			3Ø 250	DF6407FP000		DS6407MP000	
			3Ø 600	DF6414FP000		DS6414MP000	
			3Ø 208	DF6416FP000		DS6416MP000	
			3Ø 440	DF6421FP000		DS6421MP000	
4	5		3ØY 277/480	DF6504FP000	1 1/2"	DS6504MP000	1 1/2"
			3ØY 347/600	DF6514FP000		DS6514MP000	
			3ØY 120/208	DF6516FP000		DS6516MP000	
			3ØY 250/440	DF6521FP000		DS6521MP000	

MaxGard® Interconnection Systems



Male Inlet with Angle Enclosure

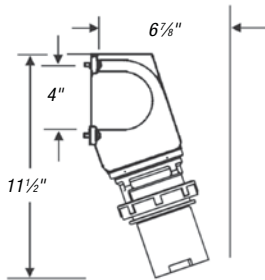

Male Inlet with Angle Adapter** and Junction Box

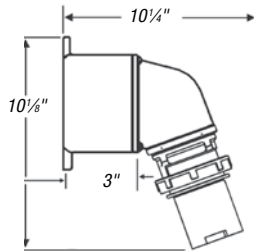

Male Inlet with Angle Adapter**

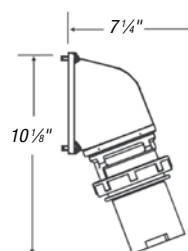

Male Inlet††

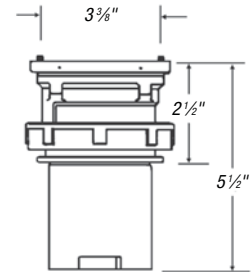

CAT. NO.	CAT. NO.	CAT. NO.	CAT. NO.
DS6104MR0E0	DS6104MRAB0	DS6104MRA00	DS6104MR000
DS6107MR0E0	DS6107MRAB0	DS6107MRA00	DS6107MR000
DS6204MR0E0	DS6204MRAB0	DS6204MRA00	DS6204MR000
DS6207MR0E0	DS6207MRAB0	DS6207MRA00	DS6207MR000
DS6214MR0E0	DS6214MRAB0	DS6214MRA00	DS6214MR000
DS6216MR0E0	DS6216MRAB0	DS6216MRA00	DS6216MR000
DS6304MR0E0	DS6304MRAB0	DS6304MRA00	DS6304MR000
DS6307MR0E0	DS6307MRAB0	DS6307MRA00	DS6307MR000
DS6316MR0E0	DS6316MRAB0	DS6316MRA00	DS6316MR000
DS6404MR0E0	DS6404MRAB0	DS6404MRA00	DS6404MR000
DS6407MR0E0	DS6407MRAB0	DS6407MRA00	DS6407MR000
DS6414MR0E0	DS6414MRAB0	DS6414MRA00	DS6414MR000
DS6416MR0E0	DS6416MRAB0	DS6416MRA00	DS6416MR000
DS6421MR0E0	DS6421MRAB0	DS6421MRA00	DS6421MR000
DS6504MR0E0	DS6504MRAB0	DS6504MRA00	DS6504MR000
DS6514MR0E0	DS6514MRAB0	DS6514MRA00	DS6514MR000
DS6516MR0E0	DS6516MRAB0	DS6516MRA00	DS6516MR000
DS6521MR0E0	DS6521MRAB0	DS6521MRA00	DS6521MR000

MaxGard® Interconnection Systems

100 Amp Standard Service

** If receptacle is desired with a Straight Adapter instead of standard Angle Adapter, substitute "S" for the "A" in the catalog number of the Receptacle with Angle Adapter or Adapter and Box.

† Standard cable bushings shown; see **page 34** for other sizes available at no extra cost if specified on order.

†† Always furnished with screw collar. We recommend cup cap with male plug; order catalog number DS1CC.

Maximum lug wire 0 AWG 19-strand or 1 AWG flexible, cable entrance .386" diameter.

Receptacles furnished with flap cap also have screw thread to accept male collar on plug.

Catalog numbers shown are for flap cap receptacles; change "DF" to "DS" for ordering screw cap.

Boldface figures are for voltage assignment. For different ratings, see **page 40**.

Outlet furnished at location "B" unless otherwise specified. 2" NPT.

▼ **Control contacts for plug/receptacles:**
Use "K" where noted. Ex: **DS1104MP00K**

For Adapters, Junction Boxes and Accessories, see **pages 34-37**.

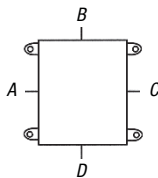

Male Plug††

Female Connector

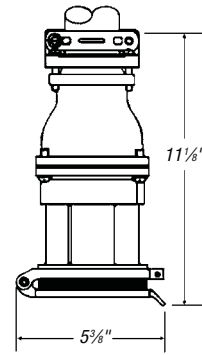
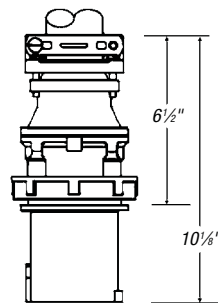

Device Ratings and Polarizations

Maximum 600VAC or 250VDC

(For full polarization, see **page 40**)

POLE	WIRE	CONDUCTOR PLACEMENT	VOLTAGE 60HZ	CAT. NO.	STANDARD BUSHING I.D. †	CAT. NO.	STANDARD BUSHING I.D. †
2	3		277	DS1104MP000	1 1/16"	DF1104FP000	1 1/16"
			125	DS1107MP000		DF1107FP000	
2	3		480	DS1204MP000	1 1/16"	DF1204FP000	1 1/16"
			250	DS1207MP000		DF1207FP000	
			600	DS1214MP000		DF1214FP000	
			208	DS1216MP000		DF1216FP000	
3	4		277/480	DS1304MP000	1 13/16"	DF1304FP000	1 13/16"
			125/250	DS1307MP000		DF1307FP000	
			120/208	DS1316MP000		DF1316FP000	
3	4		30 480	DS1404MP000	1 13/16"	DF1404FP000	1 13/16"
			30 250	DS1407MP000		DF1407FP000	
			30 600	DS1414MP000		DF1414FP000	
			30 208	DS1416MP000		DF1416FP000	
			30 440	DS1421MP000		DF1421FP000	
4	5		30Y 277/480	DS1504MP000	2"	DF1504FP000	2"
			30Y 347/600	DS1514MP000		DF1514FP000	
			30Y 118/208	DS1516MP000		DF1516FP000	
			30Y 250/440	DS1521MP000		DF1521FP000	

MaxGard® Interconnection Systems



Female Receptacle with Angle Enclosure



Female Receptacle with Angle Adapter** and Junction Box



Female Receptacle with Angle Adapter**



Female Receptacle

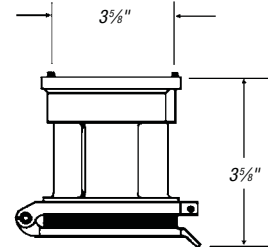
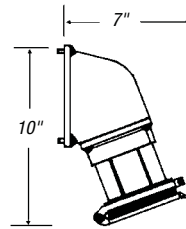
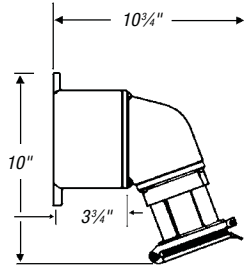
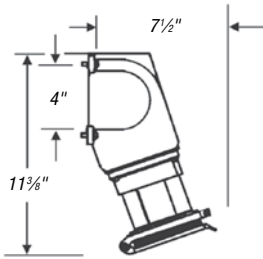

CAT. NO.	CAT. NO.	CAT. NO.	CAT. NO.
DF1104FR0E0	DF1104FRAB0	DF1104FRA00	DF1104FR000
DF1107FR0E0	DF1107FRAB0	DF1107FRA00	DF1107FR000
DF1204FR0E0	DF1204FRAB0	DF1204FRA00	DF1204FR000
DF1207FR0E0	DF1207FRAB0	DF1207FRA00	DF1207FR000
DF1214FR0E0	DF1214FRAB0	DF1214FRA00	DF1214FR000
DF1216FR0E0	DF1216FRAB0	DF1216FRA00	DF1216FR000
DF1304FR0E0	DF1304FRAB0	DF1304FRA00	DF1304FR000
DF1307FR0E0	DF1307FRAB0	DF1307FRA00	DF1307FR000
DF1316FR0E0	DF1316FRAB0	DF1316FRA00	DF1316FR000
DF1404FR0E0	DF1404FRAB0	DF1404FRA00	DF1404FR000
DF1407FR0E0	DF1407FRAB0	DF1407FRA00	DF1407FR000
DF1414FR0E0	DF1414FRAB0	DF1414FRA00	DF1414FR000
DF1416FR0E0	DF1416FRAB0	DF1416FRA00	DF1416FR000
DF1421FR0E0	DF1421FRAB0	DF1421FRA00	DF1421FR000
DF1504FR0E0	DF1504FRAB0	DF1504FRA00	DF1504FR000
DF1514FR0E0	DF1514FRAB0	DF1514FRA00	DF1514FR000
DF1516FR0E0	DF1516FRAB0	DF1516FRA00	DF1516FR000
DF1521FR0E0	DF1521FRAB0	DF1521FRA00	DF1521FR000

MaxGard® Interconnection Systems

100 Amp Reverse Service

** If receptacle is desired with a Straight Adapter instead of standard Angle Adapter, substitute "S" for the "A" in the catalog number of the Receptacle with Angle Adapter or Adapter and Box.

† Standard cable bushings shown; see **page 34** for other sizes available at no extra cost if specified on order.

†† Always furnished with screw collar. We recommend cup cap with male plug; order catalog number DS1CC.

Maximum lug wire 0 AWG 19-strand or 1 AWG flexible, cable entrance .386" diameter.

Receptacles furnished with flap cap also have screw thread to accept male collar on plug.

Catalog numbers shown are for flap cap receptacles; change "DF" to "DS" for ordering screw cap.

Boldface figures are for voltage assignment. For different ratings, see **page 40**.

Outlet furnished at location "B" unless otherwise specified. 2" NPT.

▼ **Control contacts for plug/receptacles:**
Use "K" where noted. Ex: DS1104MR00K

For Adapters, Junction Boxes and Accessories, see **pages 34–37**.

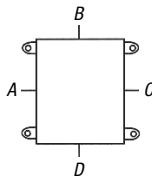

Female Connector

Male Plug††

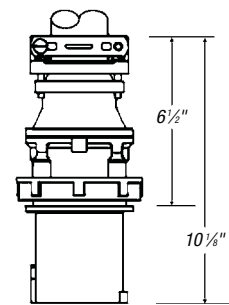
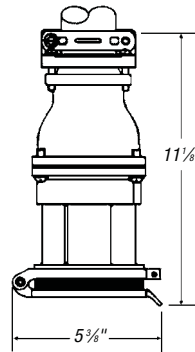

Device Ratings and Polarizations

Maximum 600VAC or 250VDC

(For full polarization, see **page 40**)

POLE	WIRE	CONDUCTOR PLACEMENT	VOLTAGE 60 HZ	CAT. NO.	STANDARD BUSHING I.D. †	CAT. NO.	STANDARD BUSHING I.D. †
2	3		277	DF1104FP000	1 1/16"	DS1104MP000	1 1/16"
			125	DF1107FP000		DS1107MP000	
2	3		480	DF1204FP000	1 1/16"	DS1204MP000	1 1/16"
			250	DF1207FP000		DS1207MP000	
			600	DF1214FP000		DS1214MP000	
			208	DF1216FP000		DS1216MP000	
3	4		277/480	DF1304FP000	1 3/16"	DS1304MP000	1 3/16"
			125/250	DF1307FP000		DS1307MP000	
			120/208	DF1316FP000		DS1316MP000	
3	4		3Ø 480	DF1404FP000	1 3/16"	DS1404MP000	1 3/16"
			3Ø 250	DF1407FP000		DS1407MP000	
			3Ø 600	DF1414FP000		DS1414MP000	
			3Ø 208	DF1416FP000		DS1416MP000	
			3Ø 440	DF1421FP000		DS1421MP000	
4	5		3ØY 277/480	DF1504FP000	2"	DS1504MP000	2"
			3ØY 347/600	DF1514FP000		DS1514MP000	
			3ØY 110/208	DF1516FP000		DS1516MP000	
			3ØY 250/440	DF1521FP000		DS1521MP000	

MaxGard® Interconnection Systems



Male Inlet with Angle Enclosure

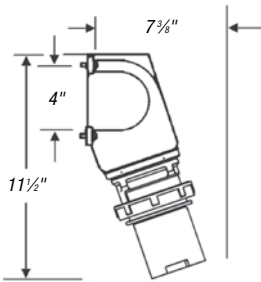

Male Inlet with Angle Adapter** and DJB3 Junction Box

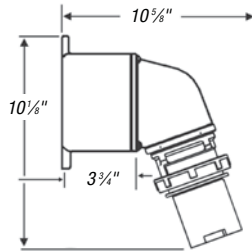

Male Inlet with Angle Adapter**

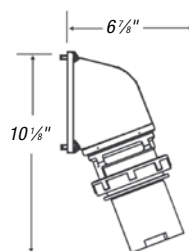

Male Inlet**

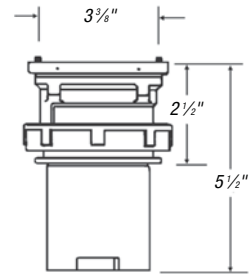

CAT. NO.	CAT. NO.	CAT. NO.	CAT. NO.
DS1104MR0E0	DS1104MRAB0	DS1104MRA00	DS1104MR000
DS1107MR0E0	DS1107MRAB0	DS1107MRA00	DS1107MR000
DS1204MR0E0	DS1204MRAB0	DS1204MRA00	DS1204MR000
DS1207MR0E0	DS1207MRAB0	DS1207MRA00	DS1207MR000
DS1214MR0E0	DS1214MRAB0	DS1214MRA00	DS1214MR000
DS1216MR0E0	DS1216MRAB0	DS1216MRA00	DS1216MR000
DS1304MR0E0	DS1304MRAB0	DS1304MRA00	DS1304MR000
DS1307MR0E0	DS1307MRAB0	DS1307MRA00	DS1307MR000
DS1316MR0E0	DS1316MRAB0	DS1316MRA00	DS1316MR000
DS1404MR0E0	DS1404MRAB0	DS1404MRA00	DS1404MR000
DS1407MR0E0	DS1407MRAB0	DS1407MRA00	DS1407MR000
DS1414MR0E0	DS1414MRAB0	DS1414MRA00	DS1414MR000
DS1416MR0E0	DS1416MRAB0	DS1416MRA00	DS1416MR000
DS1421MR0E0	DS1421MRAB0	DS1421MRA00	DS1421MR000
DS1504MR0E0	DS1504MRAB0	DS1504MRA00	DS1504MR000
DS1514MR0E0	DS1514MRAB0	DS1514MRA00	DS1514MR000
DS1516MR0E0	DS1516MRAB0	DS1516MRA00	DS1516MR000
DS1521MR0E0	DS1521MRAB0	DS1521MRA00	DS1521MR000

MaxGard® Interconnection Systems

200 Amp Standard Service

** If receptacle is desired with a Straight Adapter instead of standard Angle Adapter, substitute "S" for the "A" in the catalog number of the Receptacle with Angle Adapter or Adapter and Box.

† Standard cable bushings shown; see **page 34** for other sizes available at no extra cost if specified on order.

†† Always furnished with screw collar. We recommend cup cap with male plug; order catalog number DS2CC.

Maximum lug wire 4/0 AWG 19-strand or flexible, cable entrance .625" diameter.

Receptacles furnished with flap cap also have screw thread to accept male collar on plug.

Catalog numbers shown are for flap cap receptacles; change "DF" to "DS" for ordering screw cap.

Boldface figures are for voltage assignment. For different ratings, see **page 40**.

Outlet furnished at location "B" unless otherwise specified. 3" NPT.

▼ **Control contacts for plug/receptacles:**
Use "K" where noted. Ex: **DS2104MP00K**

For Adapters, Junction Boxes and Accessories, see **pages 34–37**.

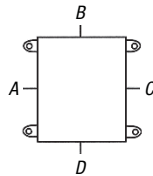

Male Plug††

Female Connector

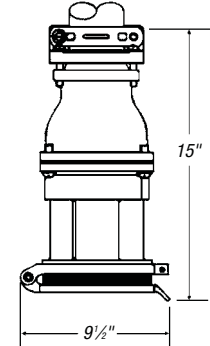
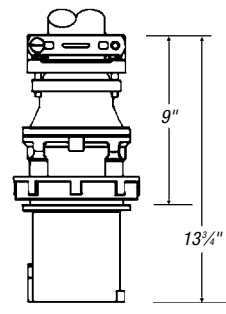

Device Ratings and Polarizations

Maximum 600VAC or 250VDC

(For full polarization, see **page 40**)

POLE	WIRE	CONDUCTOR PLACEMENT	VOLTAGE 60 HZ	CAT. NO.	STANDARD BUSHING I.D.†	CAT. NO.	STANDARD BUSHING I.D.†
2	3		277	DS2104MP000	2 1/8"	DF2104FP000	2 1/8"
			125	DS2107MP000		DF2107FP000	
2	3		480	DS2204MP000	2 1/8"	DF2204FP000	2 1/8"
			250	DS2207MP000		DF2207FP000	
			600	DS2214MP000		DF2214FP000	
			208	DS2216MP000		DF2216FP000	
3	4		277/480	DS2304MP000	2 1/4"	DF2304FP000	2 1/4"
			125/250	DS2307MP000		DF2307FP000	
			120/208	DS2316MP000		DF2316FP000	
3	4		3Ø 480	DS2404MP000	2 1/4"	DF2404FP000	2 1/4"
			3Ø 250	DS2407MP000		DF2407FP000	
			3Ø 600	DS2414MP000		DF2414FP000	
			3Ø 208	DS2416MP000		DF2416FP000	
			3Ø 440	DS2421MP000		DF2421FP000	
4	5		3ØY 277/480	DS2504MP000	2 1/2"	DF2504FP000	2 1/2"
			3ØY 347/600	DS2514MP000		DF2514FP000	
			3ØY 110/208	DS2516MP000		DF2516FP000	
			3ØY 250/440	DS2521MP000		DF2521FP000	

MaxGard® Interconnection Systems



Female Receptacle with Angle Adapter** and Junction Box



Female Receptacle with Angle Adapter**



Female Receptacle

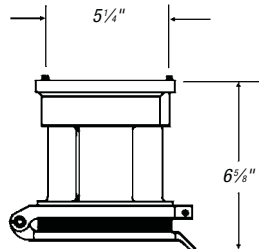
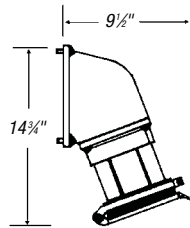
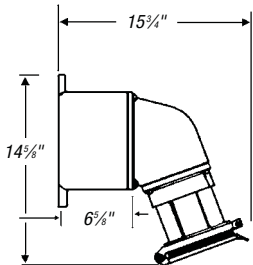

CAT. NO.	CAT. NO.	CAT. NO.
DF2104FRAB0	DF2104FRA00	DF2104FR000
DF2107FRAB0	DF2107FRA00	DF2107FR000
DF2204FRAB0	DF2204FRA00	DF2204FR000
DF2207FRAB0	DF2207FRA00	DF2207FR000
DF2214FRAB0	DF2214FRA00	DF2214FR000
DF2216FRAB0	DF2216FRA00	DF2216FR000
DF2304FRAB0	DF2304FRA00	DF2304FR000
DF2307FRAB0	DF2307FRA00	DF2307FR000
DF2316FRAB0	DF2316FRA00	DF2316FR000
DF2404FRAB0	DF2404FRA00	DF2404FR000
DF2407FRAB0	DF2407FRA00	DF2407FR000
DF2414FRAB0	DF2414FRA00	DF2414FR000
DF2416FRAB0	DF2416FRA00	DF2416FR000
DF2421FRAB0	DF2421FRA00	DF2421FR000
DF2504FRAB0	DF2504FRA00	DF2504FR000
DF2514FRAB0	DF2514FRA00	DF2514FR000
DF2516FRAB0	DF2516FRA00	DF2516FR000
DF2521FRAB0	DF2521FRA00	DF2521FR000

Staten Island Ferry

SOLUTION 200 Amp

200A MaxGard® connections on ferry deck



200A MaxGard® inlets with disconnects



30A and 200A MaxGard® interlocks



200A MaxGard® interlocks in parallel

Russellstoll® Pin and Sleeve Power Connectors

MaxGard® Interconnection Systems

200 Amp Reverse Service

** If receptacle is desired with a Straight Adapter instead of standard Angle Adapter, substitute "S" for the "A" in the catalog number of the Receptacle with Angle Adapter or Adapter and Box.

† Standard cable bushings shown; see **page 34** for other sizes available at no extra cost if specified on order.

†† Always furnished with screw collar. We recommend cup cap with male plug; order catalog number DS2CC.

Maximum lug wire 4/0 AWG 19-strand or flexible, cable entrance .625" diameter.

Receptacles furnished with flap cap also have screw thread to accept male collar on plug.

Catalog numbers shown are for flap cap receptacles; change "DF" to "DS" for ordering screw cap.

Boldface figures are for voltage assignment. For different ratings, see **page 40**.

Outlet furnished at location "B" unless otherwise specified. 3" NPT.



Female Connector

Male Plug††

▼ **Control contacts for plug/receptacles:**
Use "K" where noted. Ex: DS2104MR00K

For Adapters, Junction Boxes and Accessories, see **pages 34–37**.

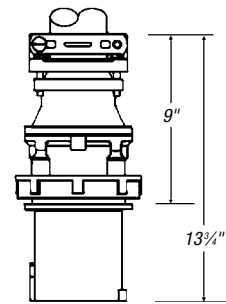
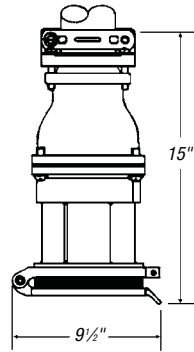
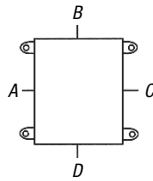

Device Ratings and Polarizations

Maximum 600VAC or 250VDC

(For full polarization, see **page 40**)

POLE	WIRE	CONDUCTOR PLACEMENT	VOLTAGE 60 HZ	CAT. NO.	STANDARD BUSHING I.D. †	CAT. NO.	STANDARD BUSHING I.D. †
2	3		277	DF2104FP000	2 1/8"	DS2104MP000	2 1/8"
			125	DF2107FP000		DS2107MP000	
2	3		480	DF2204FP000	2 1/8"	DS2204MP000	2 1/8"
			250	DF2207FP000		DS2207MP000	
			600	DF2214FP000		DS2214MP000	
			208	DF2216FP000		DS2216MP000	
3	4		277/480	DF2304FP000	2 1/4"	DS2304MP000	2 1/4"
			125/250	DF2307FP000		DS2307MP000	
			120/208	DF2316FP000		DS2316MP000	
3	4		3Ø 480	DF2404FP000	2 1/4"	DS2404MP000	2 1/4"
			3Ø 250	DF2407FP000		DS2407MP000	
			3Ø 600	DF2414FP000		DS2414MP000	
			3Ø 208	DF2416FP000		DS2416MP000	
			3Ø 440	DF2421FP000		DS2421MP000	
4	5		3ØY 277/480	DF2504FP000	2 1/2"	DS2504MP000	2 1/2"
			3ØY 347/600	DF2514FP000		DS2514MP000	
			3ØY 110/208	DF2516FP000		DS2516MP000	
			3ØY 250/440	DF2521FP000		DS2521MP000	

MaxGard® Interconnection Systems



Male Inlet with Angle Enclosure



Male Inlet with Angle Adapter**



Male Inlet††

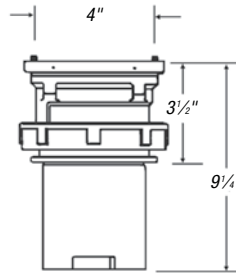
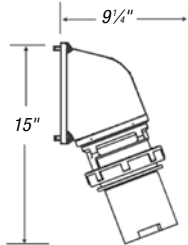
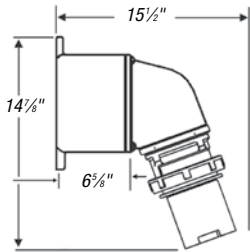

CAT. NO.	CAT. NO.	CAT. NO.
DS2104MRAB0	DS2104MRA00	DS2104MR000
DS2107MRAB0	DS2107MRA00	DS2107MR000
DS2204MRAB0	DS2204MRA00	DS2204MR000
DS2207MRAB0	DS2207MRA00	DS2207MR000
DS2214MRAB0	DS2214MRA00	DS2214MR000
DS2216MRAB0	DS2216MRA00	DS2216MR000
DS2304MRAB0	DS2304MRA00	DS2304MR000
DS2307MRAB0	DS2307MRA00	DS2307MR000
DS2316MRAB0	DS2316MRA00	DS2316MR000
DS2404MRAB0	DS2404MRA00	DS2404MR000
DS2407MRAB0	DS2407MRA00	DS2407MR000
DS2414MRAB0	DS2414MRA00	DS2414MR000
DS2416MRAB0	DS2416MRA00	DS2416MR000
DS2421MRAB0	DS2421MRA00	DS2421MR000
DS2504MRAB0	DS2504MRA00	DS2504MR000
DS2514MRAB0	DS2514MRA00	DS2514MR000
DS2516MRAB0	DS2516MRA00	DS2516MR000
DS2521MRAB0	DS2521MRA00	DS2521MR000

MMI Trailer



SOLUTION 200 Amp

Application:

Electrical hook-up of mobile medical imaging (MMI) trailers

Mobile medical units provide trailer-transportable blood banks, dental clinics, magnetic resonance imaging (MRI), X-ray and other diagnostic equipment to many hospitals and clinics throughout the country on a regular leased basis. Safe outdoor usage connections are required for up to 200-amp power supplies at each facility. Major specialized custom trailer manufacturers rely on the MaxGard® 200-amp interface.

Installation:

Site-mounted 200-amp receptacles with trailer-mounted plugs and connectors

When a mobile medical unit trailer is at the desired location, a heavy-duty MaxGard® 200-amp cable assembly connects the trailer with a corresponding receptacle or connector at each site, usually mounted on an outside wall. A primary safety feature is the receptacle's gated deadfront construction that ensures no exterior access to live receptacle contacts. With so many different hands involved on a daily basis, the MaxGard epoxy powder-coat finish and rugged waterproof construction provide hospital-safe long service life.

Russellstoll® Pin and Sleeve Power Connectors

MaxGard® Interconnection Systems

400 Amp Standard Service

** If receptacle is desired with a Straight Adapter instead of standard Angle Adapter, substitute "S" for the "A" in the catalog number of the Receptacle with Angle Adapter or Adapter and Box.

† Standard cable bushings shown; see **page 34** for other sizes available at no extra cost if specified on order.

†† Always furnished with screw collar. We recommend cup cap with male plug; order catalog number DS4CC.

Maximum lug wire 500 kcmil 37-strand or flexible, cable entrance .937" diameter.

Receptacles furnished with flap cap also have screw thread to accept male collar on plug.

Catalog numbers shown are for flap cap receptacles; change "DF" to "DS" for ordering screw cap.

Boldface figures are for voltage assignment. For different ratings, see **page 40**.

Outlet furnished at location "B" unless otherwise specified. 4" NPT.

▼ **Control contacts for plug/receptacles:**
Use "K" where noted. Ex: **DS4104MP00K**

For Adapters, Junction Boxes and Accessories, see **pages 34-37**.

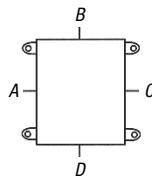

Male Plug††

Female Connector

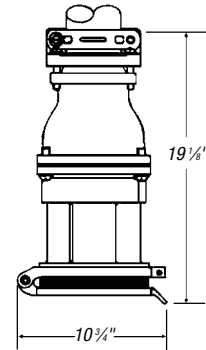
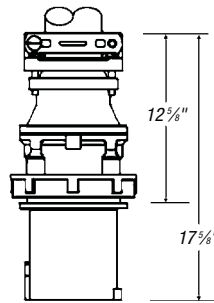

Device Ratings and Polarizations

Maximum 600VAC or 250VDC

(For full polarization, see **page 40**)

POLE	WIRE	CONDUCTOR PLACEMENT	VOLTAGE 60 HZ	CAT. NO.	STANDARD BUSHING I.D. †	CAT. NO.	STANDARD BUSHING I.D. †
2	3		277	DS4104MP000	2 1/4"	DF4104FP000	2 1/4"
			125	DS4107MP000		DF4107FP000	
2	3		480	DS4204MP000		DF4204FP000	
			250	DS4207MP000		DF4207FP000	
			600	DS4214MP000		DF4214FP000	
			208	DS4216MP000		DF4216FP000	
3	4		277/480	DS4304MP000	3"	DF4304FP000	3"
			125/250	DS4307MP000		DF4307FP000	
			120/208	DS4316MP000		DF4316FP000	
3	4		3Ø 480	DS4404MP000	3"	DF4404FP000	3"
			3Ø 250	DS4407MP000		DF4407FP000	
			3Ø 600	DS4414MP000		DF4414FP000	
			3Ø 208	DS4416MP000		DF4416FP000	
			3Ø 440	DS4421MP000		DF4421FP000	
4	5		3ØY 277/480	DS4504MP000	3 3/4"	DF4504FP000	3 3/4"
			3ØY 347/600	DS4514MP000		DF4514FP000	
			3ØY 110/208	DS4516MP000		DF4516FP000	
			3ØY 250/440	DS4521MP000		DF4521FP000	

MaxGard® Interconnection Systems



Female Receptacle with Angle Adapter** and Junction Box



Female Receptacle with Angle Adapter**



Female Receptacle

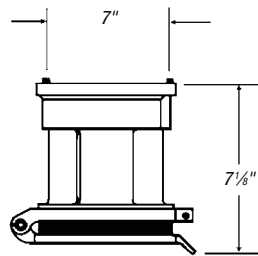
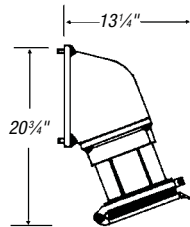
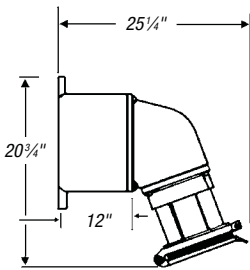

Shore-to-ship power



SOLUTION 200 Amp

Application:

Shore power to marine vessels — sightseeing boats

When docked, marine vessels need shore power when their engines aren't running. Dockside designs need to be as safe as possible during heavy use, rough treatment and adverse weather conditions. High amperage-rated systems are installed using parallel power delivery with cross-network protection.

Installation:

400-amp male inlets and power connectors with control contacts

Watertight devices are necessary for dockside installations. MaxGard® connections go further with O-rings on both pins and interiors for environmental separation and true waterproof performance. The male inlet center ground pin feature and keyed entry design align easily, make ground first and break last, while quarter-turn insertion delayed-action removal and locking screw collars provide accidental pull-out protection. Upon connector insertion, two auxiliary control contacts complete a contactor circuit, which powers the line through a make-last-and-break-first configuration. Contactors are installed separately in an on-shore sheltered power distribution panel.

This can be wired for each contactor or for multiple connections; if one plug is removed, power is cut off.

Russellstoll® Pin and Sleeve Power Connectors

CAT. NO.	CAT. NO.	CAT. NO.
DF4104FRAB0	DF4104FRA00	DF4104FR000
DF4107FRAB0	DF4107FRA00	DF4107FR000
DF4204FRAB0	DF4204FRA00	DF4204FR000
DF4207FRAB0	DF4207FRA00	DF4207FR000
DF4214FRAB0	DF4214FRA00	DF4214FR000
DF4216FRAB0	DF4216FRA00	DF4216FR000
DF4304FRAB0	DF4304FRA00	DF4304FR000
DF4307FRAB0	DF4307FRA00	DF4307FR000
DF4316FRAB0	DF4316FRA00	DF4316FR000
DF4404FRAB0	DF4404FRA00	DF4404FR000
DF4407FRAB0	DF4407FRA00	DF4407FR000
DF4414FRAB0	DF4414FRA00	DF4414FR000
DF4416FRAB0	DF4416FRA00	DF4416FR000
DF4421FRAB0	DF4421FRA00	DF4421FR000
DF4504FRAB0	DF4504FRA00	DF4504FR000
DF4514FRAB0	DF4514FRA00	DF4514FR000
DF4516FRAB0	DF4516FRA00	DF4516FR000
DF4521FRAB0	DF4521FRA00	DF4521FR000

MaxGard® Interconnection Systems

400 Amp Reverse Service

** If receptacle is desired with a Straight Adapter instead of standard Angle Adapter, substitute "S" for the "A" in the catalog number of the Receptacle with Angle Adapter or Adapter and Box.

† Standard cable bushings shown; see **page 34** for other sizes available at no extra cost if specified on order.

†† Always furnished with screw collar. We recommend cup cap with male plug; order catalog number DS4CC.

Maximum lug wire 500 kcmil 37-strand or flexible, cable entrance .937" diameter.

Receptacles furnished with flap cap also have screw thread to accept male collar on plug.

Catalog numbers shown are for flap cap receptacles; change "DF" to "DS" for ordering screw cap.

Boldface figures are for voltage assignment.

For different ratings, see **page 40**.

Outlet furnished at location "B" unless otherwise specified. 4" NPT.

▼ **Control contacts for plug/receptacles:**
Use "K" where noted. Ex: DS4104MR00K

For Adapters, Junction Boxes and Accessories, see **pages 34–37**.

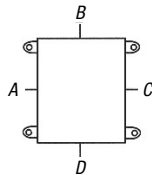

Female Connector

Male Plug††

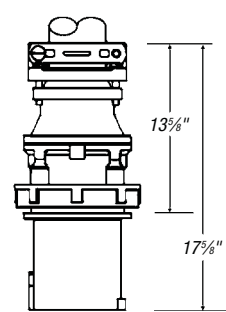
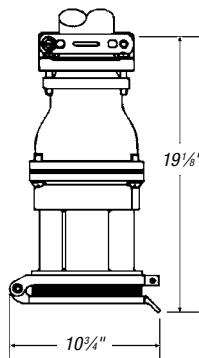

Device Ratings and Polarizations

Maximum 600VAC or 250VDC

(For full polarization, see **page 40**)

POLE	WIRE	CONDUCTOR PLACEMENT	VOLTAGE 60 HZ	CAT. NO.	STANDARD BUSHING I.D.†	CAT. NO.	STANDARD BUSHING I.D.†		
2	3		277	DF4104FP000	2 3/4"	DS4104MP000	2 3/4"		
			125	DF4107FP000		DS4107MP000			
2	3		480	DF4204FP000		3"		DS4204MP000	3"
			250	DF4207FP000				DS4207MP000	
			600	DF4214FP000				DS4214MP000	
			208	DF4216FP000				DS4216MP000	
3	4		277/480	DF4304FP000	3"	DS4304MP000	3"		
			125/250	DF4307FP000		DS4307MP000			
			120/208	DF4316FP000		DS4316MP000			
3	4		3Ø 480	DF4404FP000	3 1/4"	DS4404MP000	3 1/4"		
			3Ø 250	DF4407FP000		DS4407MP000			
			3Ø 600	DF4414FP000		DS4414MP000			
			3Ø 208	DF4416FP000		DS4416MP000			
			3Ø 440	DF4421FP000		DS4421MP000			
4	5		3ØY 277/480	DF4504FP000	3 1/4"	DS4504MP000	3 1/4"		
			3ØY 347/600	DF4514FP000		DS4514MP000			
			3ØY 120/208	DF4516FP000		DS4516MP000			
			3ØY 250/440	DF4521FP000		DS4521MP000			

MaxGard® Interconnection Systems



Male Inlet with Angle Adapter** and Junction Box

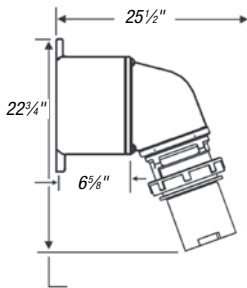

Male Inlet with Angle Adapter**

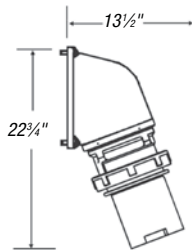

Male Inlet††

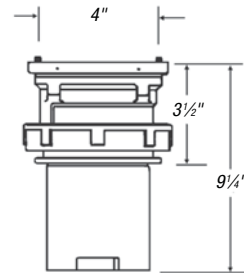

Russellstoll® Pin and Sleeve Power Connectors

CAT. NO.	CAT. NO.	CAT. NO.
DS4104MRAB0	DS4104MRA00	DS4104MR000
DS4107MRAB0	DS4107MRA00	DS4107MR000
DS4204MRAB0	DS4204MRA00	DS4204MR000
DS4207MRAB0	DS4207MRA00	DS4207MR000
DS4214MRAB0	DS4214MRA00	DS4214MR000
DS4216MRAB0	DS4216MRA00	DS4216MR000
DS4304MRAB0	DS4304MRA00	DS4304MR000
DS4307MRAB0	DS4307MRA00	DS4307MR000
DS4316MRAB0	DS4316MRA00	DS4316MR000
DS4404MRAB0	DS4404MRA00	DS4404MR000
DS4407MRAB0	DS4407MRA00	DS4407MR000
DS4414MRAB0	DS4414MRA00	DS4414MR000
DS4416MRAB0	DS4416MRA00	DS4416MR000
DS4421MRAB0	DS4421MRA00	DS4421MR000
DS4504MRAB0	DS4504MRA00	DS4504MR000
DS4514MRAB0	DS4514MRA00	DS4514MR000
DS4516MRAB0	DS4516MRA00	DS4516MR000
DS4521MRAB0	DS4521MRA00	DS4521MR000

MaxGard® Interconnection Systems

Cable Bushings for MaxGard® Plugs and Connectors

To order non-standard bushing, add cable bushing number to the end of a catalog number. The bushing is furnished at no additional cost at time of order.

Ex: DF2504FP000/DF2032.

Shaded areas show Cable Bushings provided with a strain-relief neck; larger bushings are collar style.



Size No. 3 and 6
(Identification Letter Inside Hole)



Size No. 10, 20 and 40

HOLE DIAMETER FOR CABLE	SIZE 3 30 AMP	SIZE 6 60 AMP	SIZE 10 100 AMP	SIZE 20 200 AMP	SIZE 40 400 AMP
.625"	JG63				
.750"	JG64	JG104			
.875"	JG65	JG105			
1.000"	JG66	JG106	DF1020	DF2020	
1.188"	JG67	JG107	DF1022	DF2022	
1.313"		JG108	DF1024	DF2024	
1.375"	JG69				
1.500"	JG610	JG1010	DF1026	DF2026	
1.625"					
1.688"		JG1011	DF1027	DF2027	
1.813"			DF1029	DF2029	
1.875"		JG1013	DF1030	DF2032	
2.000"			DF1032		
2.125"				DF2034	
2.250"				DF2036	
2.500"				DF2040	
2.625"					DF4042
2.750"					DF4044
3.000"					DF4048
3.250"					DF4054

Standard Cable Bushings

Notes: When ordering, select bushing size slightly larger than your cable O.D. for best fit.

Material — Neoprene

MaxGard® Interconnection Systems

Adapters for Conduit and Fittings

Adapters are tapped NPT standard pipe thread to accommodate rigid conduit or standard connectors for armored and non-metallic cable or flexible conduit.



JPA Conduit Adapters

30 AMP CAT. NO.	TAPPED HOLE SIZE NPT	60 AMP CAT. NO.	TAPPED HOLE SIZE NPT	100 AMP CAT. NO.	TAPPED HOLE SIZE NPT	200 AMP CAT. NO.	TAPPED HOLE SIZE NPT	400 AMP CAT. NO.	TAPPED HOLE SIZE NPT
JPA62	¾"	JPA104	1¼"	DFA14	1¼"	DFA25	1½"	DFA46	2"
JPA63	1"	JPA105	1½"	DFA15	1½"	DFA26	2"	DFA47	2½"
JPA64	1¼"	JPA 106	2"	DFA16	2"	DFA27	2½"	DFA48	3"
JPA65	1½"	—	—	—	—	—	—	—	—

Note:

Material — cast aluminum, corrosion-resistant copper-free alloy, electrostatic epoxy coated. Furnished complete with gasket and screws.

To specify standard plugs or connectors equipped with one of the above adapters, add the catalog number of the adapter selected to the catalog number of the plug or connector. Complete list price is the list price of the device plus list price of the adapter.

Ex.: Cat. No. DS3107MP000 with adapter tapped 1" would be Cat. No. DS3107MP000/JPA63.

Replacement Flap Covers and Screw Covers

- For connectors, receptacles and interlocks

CAT. NO.	DESCRIPTION	AMPERAGE
DFC3	Flap Cover Assembly (Weathertight)	30
DFC6		60
DFC10		100
DFC20		200
DFC40		400
DSC3	Screw Cap and STS — Lanyard Assembly (Watertight)	30
DSC6		60
DSC10		100
DSC20		200
DSC40		400









DFC6



DSC6

MaxGard® Interconnection Systems

Accessories for Receptacles

	DESCRIPTION	30 AMP CAT. NO.	60 AMP CAT. NO.	100 AMP CAT. NO.	200 AMP CAT. NO.	400 AMP CAT. NO.
	<p>Cup Caps For watertight plugs/inlets. Cup caps are used where portable equipment is on a standby basis and plugs are not in use. Effectively protect insulation and contacts from excessive moisture, dirt, dust and corrosion.</p> <p>Material — Cast aluminum, corrosion-resistant copper-free alloy, electrostatic epoxy coated with steel braid cable attached.</p>	DS3CC	DS6CC	DS1CC	DS2CC	DS4CC
	<p>Adapter Flush Frames — Single Gang Provide suitable means for mounting box covers of junction box receptacles flush in a wall.</p>	JFA6	JFA10	JFA10	JFA20	—
	<p>Adapters for Conduit Box Receptacles Adapters to fit existing boxes and for special mounting requirements can also be furnished. Consult your Thomas & Betts representative.</p> <p>20° Vertical Angle Adapter</p> <p>30° Vertical Angle Adapter</p> <p>45° Vertical Angle Adapter</p> <p>Straight Adapter</p>	JAA6-AB6 — JAA6-45 JRA6-AB6	JAA10 — JAA10-45 JRA10	DAA10 — — DRA10	DAA20 — — DRA20	— DAA40 — DRA40
	<p>Junction Box — Single Gang</p>	JB6-1	JB10-B150	JB10-B200	DJB20	DJB40
	<p>Angle Enclosure</p>	JE6	JE10	JE10M	—	—
	<p>MACK Adapter Plates Enables mounting of MaxGard® receptacles to competitive existing back boxes. This involves removing the existing non-hazardous location receptacle from back box, inserting adapter plate and installing MaxGard® receptacle. Adapter plates are available for competitors' boxes including Hubbel, Killark, Appleton and Crouse-Hinds.</p>	DCCA3	DCCA6	DCCA10	DCCA20	—
	<p>Russellstoll® Adapter Plates Adapt MaxGard® receptacles to existing J-Line™, Angle Type and Heavy-Service Ever-Lok® back boxes.</p>	DRCA3	DRCA6	DRCA10	—	N/A

MaxGard® Interconnection Systems

Replacement Interiors for Receptacles, Connectors, Plugs and Male Inlets



Russellstoll® Pin and Sleeve Power Connectors

RATING	VOLTAGE	POLARIZATION	CORRESPONDING MALE INTERIOR ASSEMBLY		CORRESPONDING FEMALE INTERIOR ASSEMBLY	
			PLUG/INLET	MALE INTERIOR	CONNECTOR/RECEPTACLE*	FEMALE INTERIOR
30A	2P3W	125VAC	DS3107MP000	DFPU3107	DF3107FP000	DFRU3107
	2P3W	250VAC	DS3207MP000	DFPU3207	DF3207FP000	DFRU3207
	3P4W	125/250VAC	DS3307MP000	DFPU3307	DF3307FP000	DFRU3307
	3P4W	3-ph 480VAC	DS3404MP000	DFPU3404	DF3404FP000	DFRU3404
	4P5W	277/480VAC	DS3504MP000	DFPU3504	DF3504FP000	DFRU3504
60A	2P3W	250VAC	DS6207MP000	DFPU6207	DF6207FP000	DFRU6207
	3P4W	125/250VAC	DS6307MP000	DFPU6307	DF6307FP000	DFRU6307
	3P4W	3-ph 480VAC	DS6404MP000	DFPU6404	DF6404FP000	DFRU6404
	4P5W	277/480VAC	DS6504MP000	DFPU6504	DF6504FP000	DFRU6504
100A	2P3W	250VAC	DS1207MP000	DFPU1207	DF1207FP000	DFRU1207
	3P4W	125/250VAC	DS1307MP000	DFPU1307	DF1307FP000	DFRU1307
	3P4W	3-ph 480VAC	DS1404MP000	DFPU1404	DF1404FP000	DFRU1404
	4P5W	277/480VAC	DS1504MP000	DFPU1504	DF1504FP000	DFRU1504
200A	3P4W	277/480VAC	DS2304MP000	DFPU2304	DF2304FP000	DFRU2304
	3P4W	3-ph 480VAC	DS2404MP000	DFPU2404	DF2404FP000	DFRU2404
	4P5W	277/480VAC	DS2504MP000	DFPU2504	DF2504FP000	DFRU2504
400A	3P4W	277/480VAC	DS4304MP000	DFPU4304	DF4304FP000	DFRU4304
	3P4W	3-ph 480VAC	DS4404MP000	DFPU4404	DF4404FP000	DFRU4404
	4P5W	277/480VAC	DS4504MP000	DFPU4504	DF4504FP000	DFRU4504

Note: For other interiors not shown, use same polarization index as plug, connector, etc. Ex: DS6416MP000 plug uses a DFPU6416 interior. If your original product had option "K - Control Contacts," include a "K" at the end of the replacement part number. Ex: If your plug/inlet is a DS3404MP00K, then the male replacement interior would be a DFPU3404K. If your connector/receptacle is a DF3404FP00K, then your female replacement/interior would be a DFRU3404K.

* To order replacement interior parts for the MaxGard Interlock, replace "DFRU" with "DFIU".

Accessories for Interlocked NEMA 12/3R Receptacles

DESCRIPTION	30 AMP CAT. NO.	60 AMP CAT. NO.	100 AMP CAT. NO.	200 AMP CAT. NO.	400 AMP CAT. NO.
Fused Disconnect Interlocked Receptacle with Safety Switch					
30-100A					
1 NO — 1 NC Contact	F34757	F34757	F34757	N/A	N/A
2 NO — 2 NC Contact	F34758	F34756B	N/A	N/A	N/A
Copper Body Lugs — 6 lugs per kit	F34756A	F34756B	F34756C	N/A	N/A
Type R Fuse Clips — 3 per kit	F34755A	F34755B	F34755C	N/A	N/A
Neutral Block	F34754A	F34754B	F34754B	N/A	N/A

MaxGard® Interconnection Systems

Pin and Sleeve Plugs, Receptacles and Systems

1.0 Scope

- 1.1 This document covers multi-contact pin and sleeve, industrial grade, arc-quenching, circuit interrupting-rated electrical plugs, motor plugs, connectors, receptacles, mechanically interlocked receptacles and assorted accessories. Usable in dry, damp, wet, marine and/or hazardous locations for electrical power circuits. Devices are to be rated 30, 60, 100, 200 and/or 400 amperes at 600VAC, 50–400 Hz and 250VDC maximum. Devices are also rated for continuous use in temperatures from -40° C to +130° C. These devices must provide internal environmental seals for marine and extreme wet applications and can be electrically interlocked.
- 1.2 The devices described shall be Thomas & Betts/Russellstoll® MaxGard® catalog numbers as specified.

2.0 Product Classifications (Features)

- 2.1 **Gated Deadfront** — All receptacles and connectors must have a rotating disk on the face of the interior, which provides live contact isolation and environmental separation.
- 2.2 **Delayed Action Arc Containment** — All devices upon disconnect under load shall have provision so the arc is contained and extinguished within the insulation cavity, making it impossible to withdraw a live plug.
- 2.3 **Flap Cover or Screw Cover Option** — Flap cover option must provide weathertight capability by utilizing a spring actuated self-closing flap. Watertight capability shall be obtained by using a gasketed screw cap.
- 2.4 **Polarization** — All devices shall be factory polarized for amperage, voltage, frequency and phase; thus providing a single voltage rating, single interface system.
- 2.5 **Grounding** — The grounding of the device shall be accomplished through a separate center ground (earth) make-first and break-last pole on all devices for complete system grounding.

- 2.6 **Pole Capabilities** — All devices shall accommodate up to four power pins plus a separate center ground pin and they shall be integral with the connector bodies (five pins total).
- 2.7 **Interior Type** — Interiors must be male (pin type) or female (sleeve type). Pins and sleeves shall also be self-aligning and self-wiping/self-cleaning.
- 2.8 **Control Contacts** — All devices must have an option for two control contacts, which shall be make-last and break-first for use in electrical interlocks and/or control circuits. See table **below**.
- 2.9 **Conductor Terminals** — Pin and sleeve connections shall employ solderless pressure-type screw terminals and be sized to accept stranded or solid copper conductors in AWG sizes (max. O.D.s as noted). The screw terminals shall also have socket heads to ensure proper torquing of wires.
- 2.10 **Environmental Seals** — Each device must have an environmental seal or O-ring around all interiors and around each pin and sleeve to prevent water and contaminants from entering the wiring compartment. This provides waterproof capability, even when not mated.
- 2.11 **Hazardous Location** — All standard plugs 30, 60 and 100 amp shall be UL® and CSA listed for hazardous location Class I Division 1, Groups C and D; Class II Division 1, Groups F and G. A hazardous location circuit breaker-protected interlock shall also be applicable to the same environments and possess all the same product features as outlined above. Enclosures shall meet NEMA 8 hazardous outdoor-duty classifications and shall meet shipboard use above deck in accordance with the Department of Transportation (USCG "Green Water").
- 2.12 **Lockout Devices** — Plug connection lockout is achieved by a padlock through plug sleeve housing hole provided for this purpose. On Hazardous Location/Explosion Proof Interlock Receptacles, lockout shall additionally be achieved by separate lockout accessory available from the factory. On standard Interlocks, lockout accessory/construction is available from the factory.

Rating for Pilot/Control Contacts

Contact Rating Code Designation A-600, Table 119.1 — UL 508 Heavy Pilot Duty Load (720 VA/600VAC) Maximum

THERMAL CONTINUOUS CURRENT AMPS	MAXIMUM CURRENT AMPERE									
	120V		240V		480V		600V		MAX. VOLT AMPERE	
	Make	Break	Make	Break	Make	Break	Make	Break	Make	Break
10 (#12 AWG)	60	6	30	3	15	1.5	12	1.2	7200	720

MaxGard® Interconnection Systems

3.0 Materials Requirements

- 3.1 **Housings** — Plug, motor plug, receptacles, connectors and interlock housings, associated covers and caps, screw collars, and clamp holders shall be made of copper-free cast aluminum (max. .004% copper).
- 3.2 **Finish** — All external surfaces except those that provide means of grounding shall be epoxy powder coated to resist corrosion.
- 3.3 **Hardware** — All hardware, external and springs, shall be stainless steel. Cable clamps shall be stainless steel or epoxy powder coated, copper-free cast aluminum.
- 3.4 **Insulators** — All device body insulators shall be molded from glass-reinforced high-strength thermoset polyester, minimum of UL® 94-V0 flammability rated.
- 3.5 **Contacts** — Contacts base material shall be made of a conductive copper alloy (brass CDA485) to prevent dezincification. Accessory material of the contacts shall be made of a compatible corrosion resistant material.
- 3.6 **Environmental Seals** — Environmental gaskets and O-rings shall be made of Neoprene material.

4.0 Design and Construction Requirements

- 4.1 **Circuit Interrupting Rating** — All devices 30, 60, 100 and 200 amperes shall be tested to be interrupted at 150% of rated current. Additionally, all devices shall be designed and tested to interrupt 100% of rated current.
- 4.2 **Wiring** — All devices shall be wired from the rear requiring no disassembly of the pins and/or sleeves from the insulated body.
- 5.0 **Applicable Documents (Compliances)**
 - 5.1 **Underwriters Laboratories (UL)** — The devices specified herein shall be listed in applicable sections of UL Standards 1010, 231, 1682 and 1686, File Nos. E2630, E57324, E68085, E123752.
 - 5.2 **Canadian Standard Association (CSA)** — The devices specified shall be listed in the applicable sections of CSA C22.2-182.1, File Number LR14096.
 - 5.3 **International Electro-Technical Commission (IEC)** — The 30-, 60- and 100-ampere devices specified shall have been tested and comply with IEC 309-1.
 - 5.4 **Federal Department of Transportation** — Refrigerated National Shipboard location devices shall meet and comply with Federal Register volume 47, number 68, subpart 111.79.
 - 5.5 **Standards** — The devices specified shall comply with Military Standards MIL-STD-105 and 1344; ASTM Standards D570 and D2565; NEMA Standard PR4-1983; and OSHA regulations when installed in accordance with the National Electrical Code® (NEC®).

5.6 NEMA 250 Enclosures Standard

- NEMA 1** — General Purpose for indoor use; guards against contact with equipment.
- NEMA 3R** — Outdoor use primarily to protect against rain, sleet, wind-blown dust and damage from external ice formation.
- NEMA 4** — Indoor or outdoor use to protect against windblown dust and rain; splashing and hose-directed water.
- NEMA 4X** — Watertight, dust-tight corrosion-resistant for indoor or outdoor applications.
- NEMA 6** — Watertight, casual/temporary immersion.
- NEMA 7** — Class I (Hazardous) for indoor use in Class I areas, per NEC®.
- NEMA 8** — Class I (Hazardous) for indoor use in Class I, oil-immersed equipment.
- NEMA 9** — Class II (Hazardous) for indoor use in Class II areas, per NEC®.
- NEMA 12** — Industrial use, dust-tight for indoor use to protect against dust, falling dirt and dripping non-corrosive liquids.

NEC and National Electrical Code are registered trademarks of the National Fire Protection Association, Inc.

MaxGard® Interconnection Systems

Single Polarization/Multiple Service* Assigned Voltages and Wiring Systems

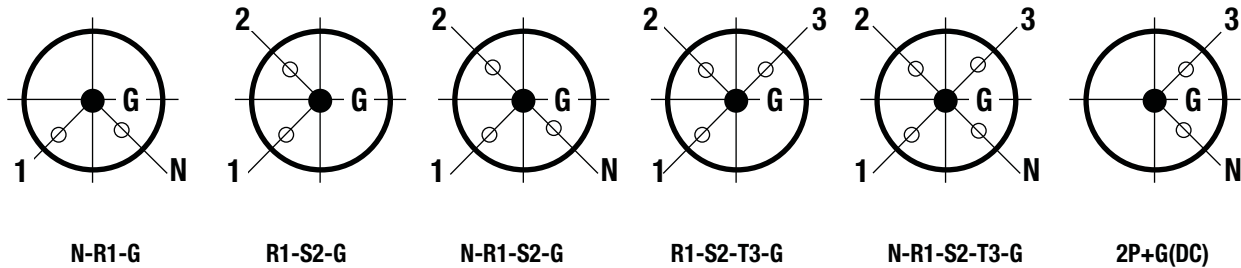

VOLTAGE ASSIGN. NO.	VOLTAGE	VOLTAGE ASSIGN. NO.	VOLTAGE	VOLTAGE ASSIGN. NO.	VOLTAGE	VOLTAGE ASSIGN. NO.	VOLTAGE	VOLTAGE ASSIGN. NO.	VOLTAGE	VOLTAGE ASSIGN. NO.	VOLTAGE	INDEX
101	220V-50 Hz	201	380V-50 Hz	301	220/380V-50 Hz	401	380V-50 Hz	501	220/380V-50 Hz			01
103	127V-50 Hz	203	220V-50 Hz	303	220/127V-50 Hz	403	220V-50 Hz	503	220/127V-50 Hz			03
104	277V-60 Hz	204	480V-60 Hz	304	277/480V-60 Hz	404	3Ø 480V-60 Hz	504	3ØY 277/480V-60 Hz			04
105	250V-50 Hz	205	440V-50 Hz	305	250/440V-50 Hz	405	3Ø 440V-50 Hz	505	3Ø 250/440V-50 Hz			05
107	125V-60 Hz	207	250V-60 Hz	307	125/250V-60 Hz	407	3Ø 250V-60 Hz	507	3ØY 125/250V-60 Hz			07
108	220V-60 Hz	208	380V-60 Hz	308	220/380V-60 Hz	408	3Ø 380V-60 Hz	508	3Ø 220/380V-60 Hz			08
109	100V-60 Hz	209	220V-60 Hz	309	100/220V-60 Hz	409	3Ø 220V-60 Hz	509	3Ø 100/220V-60 Hz			09
111	115V-400 Hz	211	220V-400 Hz	311	220/115V-400 Hz	411	220V-400 Hz	511	220/115V-400 Hz			11
—	—	—	—	—	—	—	—	513	230V DC	613	250 VDC	13
114	347V-60 Hz	214	600V-60 Hz	314	347/600V-60 Hz	414	3Ø 600V-60 Hz	514	3ØY 347/600V-60 Hz			14
115	100V-50 Hz	215	220V-50 Hz	315	100/220V-50 Hz	415	3Ø 220V-50 Hz	515	3Ø 100/220V-50 Hz			15
116	120V-60 Hz	216	208V-60 Hz	316	120/208V-60 Hz	416	3Ø 208V-60 Hz	516	3ØY 120/208V-60 Hz			16
117	120V-400 Hz	217	208V-400 Hz	317	120/208V-400 Hz	417	3Ø 208V-400 Hz	517	3Ø 120/208V-400 Hz			17
—	—	—	—	—	—	—	208V	—	—	618	28 VDC	18
—	—	221	440V-60 Hz	321	250/440V-60 Hz	421	3Ø 440V-60 Hz	521	3ØY 250/440V-60 Hz			21
—	—	—	—	—	—	—	250V	Reserved	—	—	—	22
—	—	—	—	—	—	—	480V	Reserved	—	—	—	23
—	—	—	—	—	—	—	600V	Reserved	—	—	—	24

MaxGard® receptacles and plugs may be furnished in any of the above voltage and phasing systems.

To order any device in a voltage and phasing not shown in the preceding catalog pages, substitute the Voltage Assignment Number in the **above** chart for that portion of the listed catalog number appearing in **boldface** type.

Example: 200 Amp Weathertight Receptacle with Flap Cover, Angle Adapter and Junction Box for 3Ø 480 volt (3-pole and ground) is DF2404FRAB0.

To change to 3Ø 208 volt, the catalog number becomes DF2416FRAB0.

Note: All devices may be furnished with two control contacts. Add "K" to the end of the catalog number, in place of last position Ø.

*** Dual-Voltage or Multiple-Service Applications** (for any given polarization number) — Example: A factory installation may consist of all receptacles specified and wired at polarization "507." This is a 3ph. Y-125/250V-60 Hz supply. However, all circuit requirements "below" (507) can also be met; for instance a "207" plug will draw phasing for 250V-60 Hz operation of equipment as well, while another ".507" receptacle supplies power for a 3-phase motor installation. See chart **above**.

For non-interrupting polarizations at 45, 90, 150, 300, 600A ratings, consult Technical Services.

MaxGard® Interconnection Systems

Male Plug

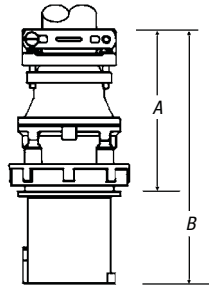

AMP	A	B
30	4 ³ / ₄ "	7 ⁷ / ₈ "
60	5 ¹ / ₂ "	9 ¹ / ₈ "
100	6 ¹ / ₂ "	10 ¹ / ₈ "
200	9"	13 ³ / ₄ "
400	12 ⁵ / ₈ "	17 ⁵ / ₈ "

Connector

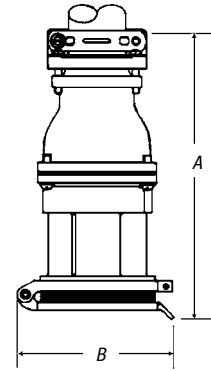

AMP	A	B
30	8 ³ / ₄ "	5 ¹ / ₈ "
60	10"	5 ³ / ₈ "
100	11 ¹ / ₈ "	5 ³ / ₈ "
200	15"	9 ¹ / ₂ "
400	19 ⁵ / ₈ "	10 ³ / ₄ "

Russellstoll® Pin and Sleeve Power Connectors

Male Inlet

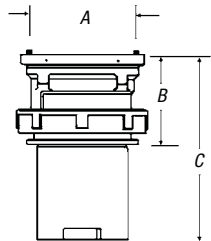

AMP	A	B	C
30	2 ⁵ / ₈ "	2 ¹ / ₂ "	5 ¹ / ₂ "
60	3 ³ / ₈ "	2 ¹ / ₂ "	5 ¹ / ₂ "
100	3 ³ / ₈ "	2 ¹ / ₂ "	5 ¹ / ₂ "
200	5 ¹ / ₄ "	3 ¹ / ₂ "	9 ¹ / ₄ "
400	3 ⁵ / ₈ "	4 ³ / ₈ "	9 ¹ / ₄ "

Receptacle with Angle Enclosure

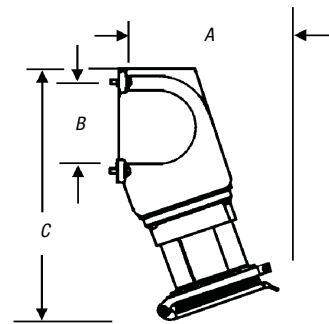

AMP	A	B	C
30	6 ⁵ / ₈ "	3 ¹ / ₈ "	9 ¹ / ₈ "
60	7 ¹ / ₈ "	4"	11 ¹ / ₈ "
100	7 ¹ / ₂ "	4"	11 ¹ / ₈ "
200	—	—	—
400	—	—	—

(Flap covers shown — screw covers available. On all, screw covers have nominal effect on outside dimensions.)

MaxGard® Interconnection Systems

Receptacle with Angle Adapter and DJB Junction Box

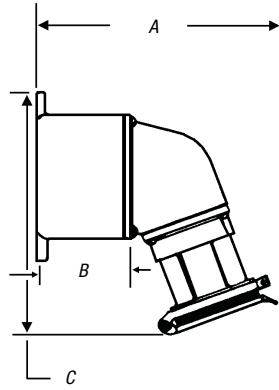

AMP	A	B	C
30	9 ¹ / ₈ "	3"	9 ⁵ / ₈ "
60	10 ¹ / ₂ "	3"	9 ³ / ₄ "
100	10 ³ / ₄ "	3 ³ / ₄ "	10"
200	15 ³ / ₄ "	6 ⁵ / ₈ "	14 ⁵ / ₈ "
400	25 ¹ / ₄ "	12"	20 ³ / ₄ "

Receptacle with Angle Adapter

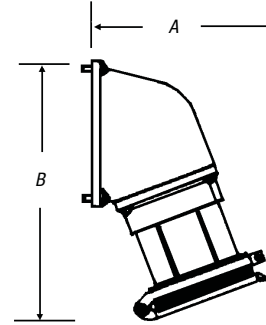

AMP	A	B
30	6 ¹ / ₈ "	9 ⁵ / ₈ "
60	7 ¹ / ₂ "	9 ³ / ₄ "
100	7"	10"
200	9 ¹ / ₂ "	14 ⁵ / ₈ "
400	13 ¹ / ₄ "	20 ³ / ₄ "

(Flap covers shown — screw covers available. On all, screw covers have nominal effect on outside dimensions.)

Receptacle Only

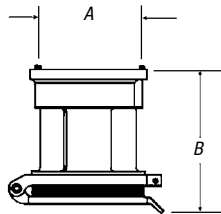

AMP	A	B
30	2 ⁷ / ₈ "	4 ¹ / ₂ "
60	3 ³ / ₈ "	5 ¹ / ₈ "
100	3 ⁵ / ₈ "	5 ³ / ₈ "
200	5 ¹ / ₄ "	6 ⁵ / ₈ "
400	7"	7 ⁵ / ₈ "

MaxGard® Interconnection Systems

Industrial interlocked receptacles are available in 30 through 400 Amp. Switched receptacles have mechanical linkages for added safety. Safety features include:

- Plugs cannot be inserted unless power is safely turned off
- Plugs cannot be removed until power is safely turned off
- Specialty designs may also automatically disengage power if plug is removed while power is on, either mechanically or electrically

Applications

Applications where these units are most commonly used are:

- Welding stations in automotive and heavy industry
- Temporary and portable power distribution for construction
- Marine shore-to-ship power
- Industrial machinery installation
- Portable power distribution, vehicle and gen-set power for aerospace
- Custom systems in all industries



Russellstoll® Pin and Sleeve Power Distribution Systems

Sample Installation: Fixed Power Source (Wall) to Remote/Portable Location

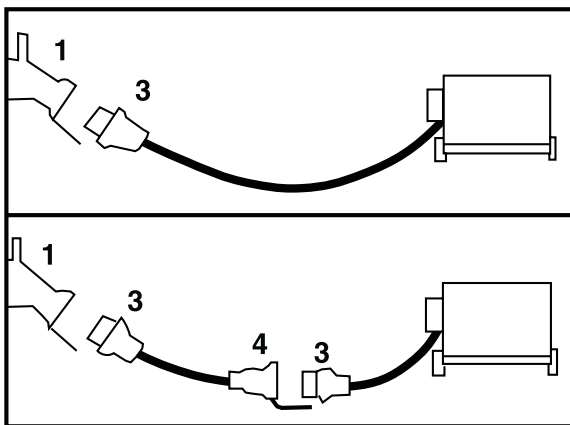

1. Receptacle (wall-mounted female)
2. Receptacle (panel-mounted female)
3. Plug (attachment)

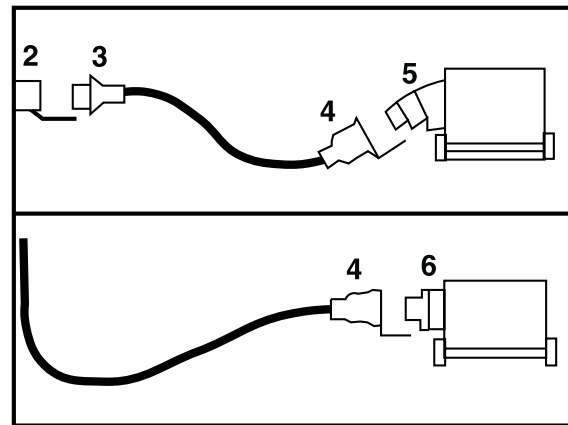

4. Female connector
5. Male Inlet with angle adapter
6. Male inlet with straight adapter

Other installations: generator power sources, custom control circuits, multiple voltage service — contact Technical Services.

MaxGard® Interconnection Systems

MaxGard® Fused-Disconnect** Interlocked Receptacle with Disconnect Switch

MaxGard® Fused-Disconnect Interlocked Receptacle with Safety Switch meets UL®, NEC® and major automotive specifications. This unit is the maximum in:

Safety

- Door safety switch with three external lockout points
- Safety fuse pulls for standard class R fuses
- Backup door safety latch

Durability

- Heavy .060 steel galvaneel with baked enamel, NEMA 3R/12 construction
- Clear shield for test probes

Performance

- Standard 600V cartridge fuse clips and spacing
- Fully interlocked MaxGard® receptacle
- Angled front receptacle for easier access



Ordering Information

Maximum 600VAC or 250VDC

Notes: **Non-fused, non UL version available:

Specify DNRF _____.

Standard polarizations shown. Boldface figures are for voltage assignment; for different ratings, see page 40.

User Made Possible Conduit Hubs

AMP	STD. NPT THREAD OUTLET	MAX.
30	1½"	2½"
60	2"	2½"
100	2"	2½"

Specifications on pages 38–39.

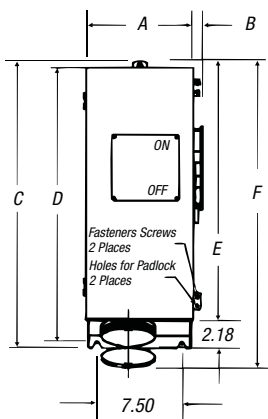

	POLES/ WIRES	VOLTAGE	FUSED DISCONNECT** INTERLOCKED RECEPTACLE		
			NEMA 12/3R CAT. NO.	MATING MAXGARD PLUG CAT. NO.	STD. BUSHING ID
30 AMP	2P3W	125	DFRF31070	DS3107MP000	¾"
	2P3W	250	DFRF32070	DS3207MP000	¾"
	3P4W	3Ø250	DFRF33070	DS3307MP000	1"
	3P4W	3Ø480	DFRF34040	DS3404MP000	1"
	4P5W	277/480	DFRF35040	DS3504MP000	1¼"
60 AMP	2P3W	250	DFRF62070	DS6207MP000	1¼"
	3P4W	125/250	DFRF63070	DS6307MP000	1¼"
	3P4W	3Ø480	DFRF64040	DS6404MP000	1¼"
	4P5W	277/480	DFRF65040	DS6504MP000	1½"
100 AMP	2P3W	250	DFRF12070	DS1207MP000	1½"
	3P4W	125/250	DFRF13070	DS1307MP000	1½"
	3P4W	3Ø480	DFRF14040	DS1404MP000	1½"
	4P5W	277/480	DFRF15040	DS1504MP000	2"

▼ Control Contacts (position 9) use "K" example: DFRF1207K.
Always use liquidtight fittings to limit condensation entry.

Dimensions

AMP	A	B	C	D	E	F
30	9½"	¾"	25¾"	25"	22¾"	30"
60	9½"	¾"	25¾"	25"	22¾"	30"
100	9½"	¾"	25¾"	25"	22¾"	30"



MaxGard® Interconnection Systems

Maximum 600VAC/250VDC

MaxGard® NEMA 4X interlocks are ideal for demanding non-hazardous areas where dust, dirt, moisture and corrosion might be a problem — such as shipyards, food processing facilities, manufacturing operations or similar areas.

Safety

- Gated deadfront waterproof receptacle
- Standard, high AIC or NA/switch circuit breaker
- Protective screw cap for watertight protection

Durability

- Thick-wall cast copper-free aluminum housing with epoxy powder-coat finish
- Heavy-duty sliding bar interlock mechanism

Performance

- Heavy on/off handle adds mechanical ability to electrical interlock function
- Standard conduit openings through top or side

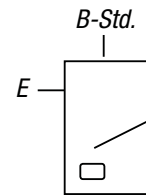
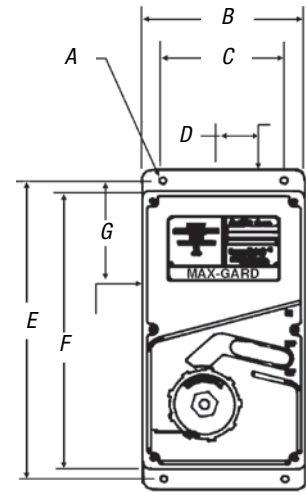

Russellstoll® Pin and Sleeve Power Connectors



Boldface figures are for voltage assignment; for different ratings, see page 40.

	POLES/ WIRES	VOLTAGE	MECHANICALLY INTERLOCKED RECEPTACLE NEMA 4X CAT. NO.	MATING MAXGARD PLUG CAT. NO.	STD. BUSHING ID
30 Amp	2P3W	125	DBRS310703000	DS3107MP000	7/8"
	2P3W	250	DBRS320703000	DS3207MP000	7/8"
	3P4W	30/250	DBRS330703000	DS3307MP000	1"
	3P4W	30/480	DBRS340403000	DS3404MP000	1"
60 Amp	4P5W	277/480	DBRS350403000	DS3504MP000	1 1/16"
	2P3W	250	DBRS620706000	DS6207MP000	1 3/16"
	3P4W	125/250	DBRS630706000	DS6307MP000	1 5/16"
	3P4W	30/480	DBRS640406000	DS6404MP000	1 5/16"
100 Amp	4P5W	277/480	DBRS650406000	DS6504MP000	1 1/2"
	2P3W	250	DBRS120710000	DS1207MP000	1 11/16"
	3P4W	125/250	DBRS130710000	DS1307MP000	1 13/16"
	3P4W	30/480	DBRS140410000	DS1404MP000	1 3/8"
200 Amp	4P5W	277/480	DBRS150410000	DS1504MP000	2"
	3P4W	277/480	DBRS230720000	DS2307MP000	1 1/4"
	3P4W	30/480	DBRS240420000	DS2404MP000	2 1/4"
	4P5W	277/480	DBRS250420000	DS2504MP000	2 1/2"
400 Amp	3P4W	277/480	DBRS430740000	DS4307MP000	3"
	3P4W	30/480	DBRS440440000	DS4404MP000	3"
	4P5W	277/480	DBRS450440000	DS4504MP000	3 1/4"

(Flap-Cap available by replacing "DBRS" with "DBRF")

Conduit Hubs: (at B or E)

AMP	STD. NPT THREAD OUTLET	MAX.
30	1 1/2"	2 1/2"
60	1 1/2"	2 1/2"
100	2"	2 1/2"
200	2"	3"
400	4"	4"

▼ **Control Contacts** (position 12) use "K" example: DBRS6104060K0

Shunt Trip Breaker (position 13) add "Z" to above: DBRS6104060KZ

Breaker Trip Ratings (positions 9, 10, 11) 30 amp use 030; 60 amp use 060; alternate trip ratings available — consult Technical Services

Non-Auto Sw. NAO (repl. "DBRF" with "DSRF")

For additional full line and polarization options, see page 40.

Dimensions

AMP	A	B	C	D	E	F	G
30	3/8"	8 3/4"	6 1/2"	1 1/2"	16 1/4"	15 1/8"	3 1/8"
60	3/8"	8 3/4"	6 1/2"	1 1/2"	16 1/4"	15 1/8"	3 1/8"
100	3/8"	8 3/4"	6 1/2"	1 1/2"	16 1/4"	15 1/8"	3 1/8"
200	3/8"	12 1/4"	9"	2 1/2"	26 1/4"	24 3/4"	5"
400	3/8"	15 1/2"	12"	3"	30 1/2"	29"	6"

MaxGard® Interconnection Systems

Explosion-Proof Applications

Russellstoll® Hazardous-Duty Plugs, Receptacles and Interlocks are designed to support a variety of installation needs throughout 20A, 30A, 60A and 100A ranges where Division 1, Class 1 NEC® guidelines require the utmost in safety.

Unique among others, the Russellstoll® MaxGard® also offers true O-ring sealed waterproof design protection in addition to standard threaded flame-path construction employed elsewhere. In rough service, washdown and outdoor applications, MaxGard® performance goes beyond normal explosion-proof ratings.

With coming increases in harmonized designations for classifications between NFPA/NEC® and IEC (International) hazardous area standards, a quick reference classification chart is provided below. In all cases, the customer must determine and approve proper area classification standards and degree of harmonized standards acceptance.



HAZARDOUS MATERIALS ENVIRONMENT	U.S. NEC STANDARDS	EURO IEC STANDARDS
Gas or Vapor	Div. 1, Class I Div. 2, Class I	Zone 0 and 1 Zone 2
Dust	Div. 1, Class II Div. 2, Class II	Zone 10 Zone 11
Fibers/Flyings	Div. 1, Class III Div. 2, Class III	Zone 10 Zone 11
GROUP APPLICATIONS	NEC ART. 500 CLASS I: GROUPS	NEC ART. 505 ZONES 0, 1 AND 2
Div. 1 and 2, Class I	A: Acetylene	IIC
	B: Hydrogen	IIB
	C: Ethylene	IIA
	D: Propane	

The above chart is presented for quick reference only and should only be used in conjunction with noted Articles. Further definition of harmonized standards will be supported by Russellstoll through appropriate specification efforts whenever practical.

MaxGard® Interconnection Systems

MaxGard® DBRE and DSRE Series Interlocks are the only devices certified both explosion-proof and waterproof, along with optional control contacts, and are fully UL® Listed.

Explosion-Proof Waterproof Circuit Breaker Interlocked Receptacle

Available in 30-, 60- and 100-amp sizes, all polarizations. Division 1, Class I and II.



UL and CSA listed for hazardous locations

Class I, Division 1, Groups B, C and D
 Class II, Division 1, Groups F and G
 UL File E10919
 NEMA 7, 8, 9
 CSA
 DOT shipboard used above deck "green water"
 NEMA 4X
 USCG approved



Explosion-Proof Non-Interlocked Receptacle

Available in 30A 480VAC max., all polarizations

- Factory-sealed interior (no filled conduits)
- Easy low-cost installation



UL and CSA listed for hazardous locations

Class I, Division 1, C and D
 Class II, Division 1, Groups F and G
 UL File E10919
 NEMA 7, 8, 9
 CSA
 DOT shipboard used above deck "green water"
 NEMA 4X
 USCG approved



MaxGard® Interconnection Systems

Maximum
600VAC or 250VDC



Explosion-Proof Interlocked
Receptacle with Circuit Breaker
Class I, Class II



Explosion-Proof
Receptacle, Class I, Class II



Male Plug

	POLES/ WIRES	VOLTAGE (VAC)	CAT. NO.	CAT. NO.	CAT. NO.	STD. BUSHING I.D.*
30 Amp						
	2P3W	125	DBRE310703000	DSE3107FRO	DS3107MP000	7/8"
	2P3W	250	DBRE320703000	DSE3207FRO	DS3207MP000	7/8"
	3P4W	30250	DBRE330703000	DSE3307FRO	DS3307MP000	1"
	3P4W	30480	DBRE340403000	DSE3404FRO	DS3404MP000	1"
	4P5W	277/480	DBRE350403000	DSE3504FRO	DS3504MP000	1 1/8"
60 Amp						
	2P3W	250	DBRE620706000	—	DS6207MP000	1 1/8"
	3P4W	30250	DBRE630706000	—	DS6307MP000	1 1/8"
	3P4W	30480	DBRE640406000	—	DS6404MP000	1 1/8"
	4P5W	277/480	DBRE650406000	—	DS6504MP000	1 1/2"
100 Amp						
	2P3W	250	DBRE120710000	—	DS1207MP000	1 11/16"
	3P4W	30250	DBRE130710000	—	DS1307MP000	1 13/16"
	3P4W	30480	DBRE140410000	—	DS1404MP000	1 13/16"
	4P5W	277/480	DBRE150410000	—	DS1504MP000	2"

Boldface figures are for voltage assignment; for different ratings, see **page 40**.

* For additional bushing sizes, accessories and specification information, see **pages 34–39**.

Note: For additional full line and polarization options, see **page 40**.

▼ **Control Contacts** (position 12) use "K" example: DBRE6404060K0

Shunt Trip Breaker (position 13) add "Z" to above: DBRE6404060KZ

Breaker Trip Ratings (positions 9, 10, 11) 30 amp use O30; 60 amp use O60; alternate trip ratings are available — consult Technical Services

Non-Auto Sw. NAO (repl. "DBRE" with "DSRE")

MaxGard® Interconnection Systems

Dimensions

Explosion-Proof Receptacle

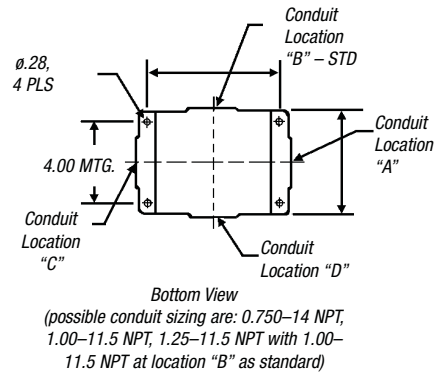
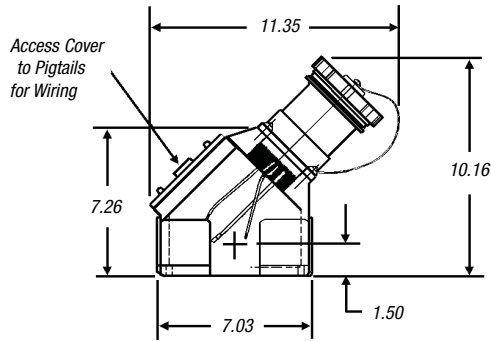

Explosion-Proof Interlocked Receptacle

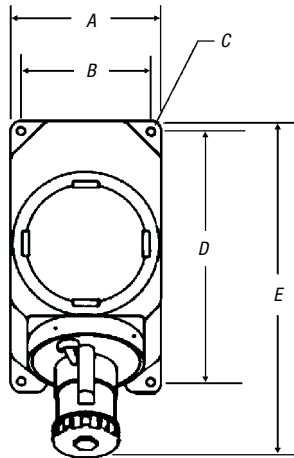

Conduit Sizing

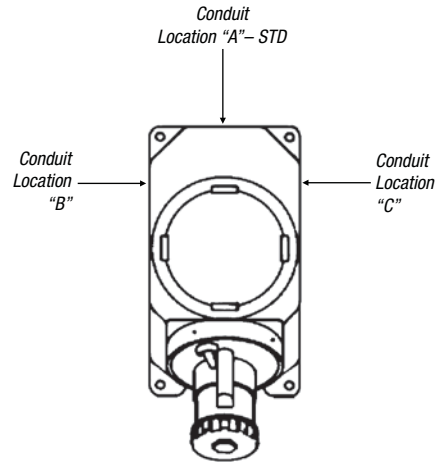

AMP	A	B	C	D	E
30	8¾"	7½"	½"	14¾"	20"
60	8¾"	7½"	½"	14¾"	20"
100	8¾"	7½"	½"	14¾"	20"

AMP	STANDARD
30	1.25"
60	1.50"
100	2.00"

Note: Range is 0.750–14 NPT through 2.00–11.5 NPT.

GSUL Safe Ground Indicator System

Prevents operation of pumps without a safe ground for static dissipation.

Class I, Division 1, Groups C, D, and Zone 1, Groups IIB, IIA; NEMA 7 Class II, Division 1, Groups E, F, G; NEMA 9

Instant Visual Confirmation of Safe Ground

The Russellstoll® GSUL Safe Ground Indicator System is designed to ensure that a safe ground has been established for dissipating ever-present static electricity from tank vehicles, carriers, drums and other conductive equipment before allowing the transfer of flammable materials. The GSUL indicates the establishment of a safe ground via two parallel-connected green signal lights. Two lights are used for redundancy — if one lamp burns out, visual indication of safe grounding will be maintained by the other.

Intrinsically Safe Circuitry

The GSUL Safe Ground Indicator System features an intrinsically safe, low-energy ground-sensing circuit, which does not carry sufficient electrical energy to cause ignition in classified Hazardous Locations.

In operation, the ground-sensing circuit extends through the grounding clamp and its connection to the ground indicator, the metal portion of the vehicle between the jaw terminals of the clamp and earth ground electrode.

Pumps Won't Operate Until Safe Ground Is Established

A control relay in the GSUL Safe Ground Indicator System provides interlocked control of pump motors at the loading platform. The electronic control circuit will be de-energized while the green lights are off. Attaching the clamps to the tank closes the interlocking contact and energizes the control circuits to the motors.

Applications

Volatile or classified areas such as:

- Tank farms
- Petrochem
- Cosmetics
- Grain mills
- Vehicular or rail transport

..... Specifications

Enclosure: Cast copper-free aluminum with epoxy powder-coated finish

Outlets: Regularly furnished tapped ¾" NPT

Relay Contacts: Rated ½ HP, 10A, 120VAC; ½ HP, 10A, 240VAC

Certifications: UL® Listed, CSA Certified



Unit shown with covers removed

GSUL Safe Ground Indicator System

GSUL Safe Operating Features

- Two redundant, parallel green indicator lights glow when safe ground is established
- Lamps offer approximately 20,000 hours of operating life
- Unit may be ordered without lights where remote visual indication is desired
- Intrinsically safe, simplified circuitry
- Integral, intrinsically safe wiring compartment with approved strain-relief fitting for connection of cable from grounding clamp
- Solid-state actuating and control circuits mounted on removable printed circuit board
- Enclosure protects components against moisture
- Control relay provided for interlocked control of pump motor at loading rack
- Grounding clamp (ordered separately) provides dual isolated tip contacts in a heavy-duty cast-aluminum handle design

Wiring Diagram

Ground Electrode Connection
(1 electrode required not provided by Russellstoll)

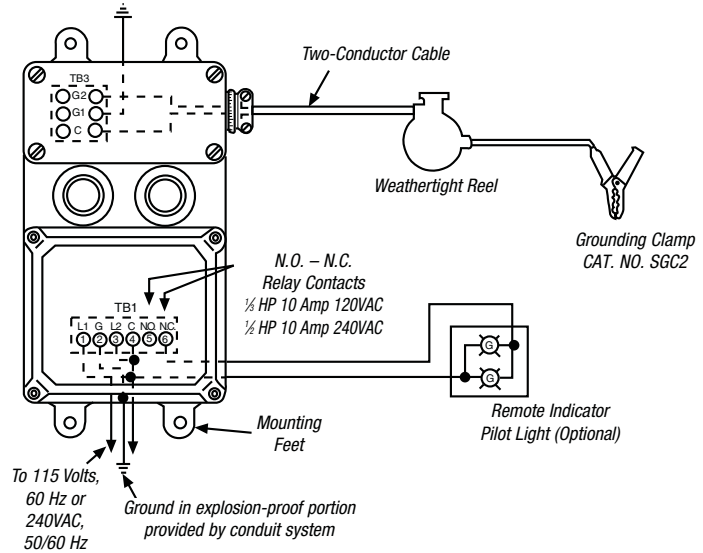

Russellstoll® Pin and Sleeve Power Connectors

Typical Installation



GCC1

Aerospace/Industrial Static Ground Devices

Static grounding receptacles are used in airport and aerospace installations worldwide during fueling, testing and maintenance procedures. Normal mounting is concrete/tarmac floor inset, threaded onto copper ground rod.

Heavy brass construction cup includes optional cover and receptacle's contact pin. Accommodates a wide variety of single-contact (copper on steel wire) static ground wire clamps in service.

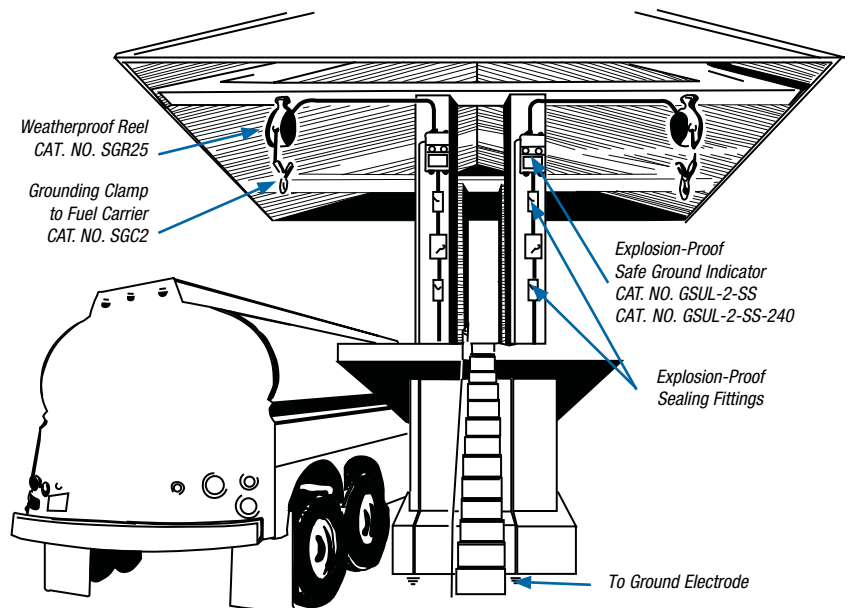

Loading rack illustration suggests a typical installation, which includes an Explosion-Proof Switch, Explosion-Proof Sealing Fittings, Weatherproof Reel and the GSUL-2-SS Safe Ground indicator with 2-wire grounding clamp.

CAT. NO.	DESCRIPTION
GCC1	Ground cup with cover*
GC1	Ground cup without cover*
F06146	Replacement contact tip**

* Hub is tapped for 3/4"-10.

** Hub is tapped for 1/2"-13.

GSUL Safe Ground Indicator System

Russellstoll® Pin and Sleeve Power Connectors



GSUL-2-SS

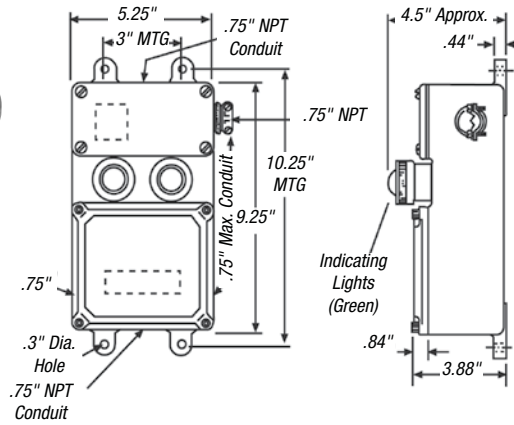

SGC2



SGR25
SGR50
SGR75

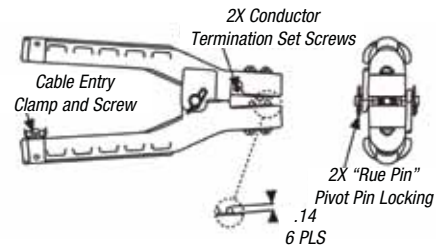
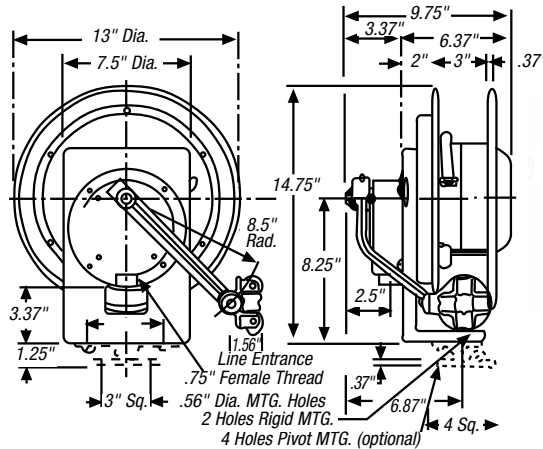

CAT. NO.	DESCRIPTION
GSUL2SS	Safe Ground Indicator with Indicator Lights, 120V, UL®/CSA
GSUL2SS-240	Safe Ground Indicator with Indicator Lights, 240V, CSA
SGC2	Safe Ground Static Clamp
SGR25	Weathertight Retracting Reel with 25 ft. of 12/2 SJO-W Cable
SGR50	Weathertight Retracting Reel with 50 ft. of 12/2 SJO-W Cable
SGR75	Weathertight Retracting Reel with 75 ft. of 12/2 SJO-W Cable
Replacement Parts for GSUL	
C13662	Printed Circuit Board, 120 Volts (includes relay)
GX24RCB	Printed Circuit Board, 240 Volts (includes relay)
F30674	Control Relay
F30602	Lamp Socket Assembly
ELAG	Pilot Light Globe Assembly (green)
310993	Lamp for GSUL2SS
Replacement Parts for SGC2	
GX2TK	Ground Clamp Repair Kit

DuraGard® Waterproof Connections

In this section...



DuraGard® Waterproof Connections

Overview	54–57
20 Amp.....	58–59
30 Amp.....	60–61
50 Amp.....	62–63
60 Amp.....	64
Accessories	65–66
Safety Interlocks.....	67
Dimensions.....	68
Engineering Specifications.....	69–70

Thomas & Betts

A Member of the ABB Group

www.tnb.com

DuraGard® Waterproof Connections

Non-Metallic Plugs, Connectors, Receptacles and Inlets — 20, 30, 50 and 60 Amp, Maximum 600VAC/250VDC



Safety

- **Truly waterproof:** Not just watertight, but waterproof (tested under 1000 PSI)
- **Exclusive waterproof features:** The only thermoplastic connector designed to prevent short circuits due to water ingress under high water pressure
- **Different power supply ratings can't mix:** Six single-rate device polarizations ensure exact voltage, frequency and phase differentiation
- **Added safety measures:** Safety ground makes first, breaks last
- **Ultimate waterproof connection:** Watertight mated or unmated, while many watertight specifications cover mated connections only

Durability

- **Designed for durability:** DuraV® housing material specially selected for hot or cold and chemical washdown duty (flame-safe UL® 94-V0 rated housings)
- **Versatile functionality:** Pin and sleeve design enables higher current flow at cooler temperatures due to large contact circular areas
- **Built to last:** A longer system life under corrosive environments

Performance

- **Long life:** Round, self-cleaning, constant-pressure pin and sleeve contacts of solid CDA 360 brass for long, reliable electrical life
- **Easy installation:** Drop-in assemble interior and easy pressure screw wire termination
- **Reliability:** DurOring™ sealing system for each pin and sleeve and interior assembly
- **Application flexibility:** Bushing size available for every cable diameter
- **Continuous operation:** Superior performance in corrosive environments

DuraGard® Waterproof Connections

Russellstoll® Pin and Sleeve Power Connectors

Russellstoll® Line Selections for Outdoor (and Indoor) Applications

DuraGard® to 3P4W 20 through 60A

The toughest design and construction in thermoplastic safety, durability and performance in UL 94-V0 flame-rated DuraV® material. With DurOring™ sealed pins, sleeves and interiors are watertight even unmated. A 30A and 50A Circuit Breaker Interlock line in DuraV® are the best choices for standard voltage polarization options through 600VAC (Interlock to 480VAC).

Interlocked Outlets 20 through 60A

USCG Accepted 20–50A convenience Interlocked Receptacles accept DuraGard® plugs. Built from aluminum or brass for rough-service installations, in Switched or Circuit Breaker formats, their extremely heavy-duty designs provide maximum durability.

IEC (IP67) to 4P5W 20 to 100A

Thermoplastic international standard IEC 309-2 or CEE-17 connector usage is growing especially in OEM, export and standard performance applications. The IP67 style is watertight when mated and directly interchangeable with other manufacturers. International designations shadow U.S. amperage ratings: 20/(16), 30/(32), 60/(63) and 100/(125) amps. IP67 devices have screw collars or flap/screw covers, with catalog number “W” suffixes.



Typical Application Groups

Marine

- Lighting Connectors
- Shore-to-Ship Power
- Low-Power Welding
- Power Distribution Panels
- Shipboard Power Outlets
- Barge Power Connection

Food Processing, Brewery/ Beverage, Pulp and Paper, Pharmaceuticals, Portable Building Power

- Welding Outlets
- Motor Power Connections
- Lighting Systems
- Machinery Interconnections
- Process Control Power Systems

Construction and Agricultural

- Generator Set Panels
- Portable Tools and Equipment
- Irrigation Systems Panels
- Portable Lighting and Equipment

OEMs

- Export Machinery
- Critical Power Connections and Welding Systems
- Transportable Equipment

Usage

- Any application where electrical connections need protection from water and/or dust entrance to the contacts or the wiring compartment
- Cable-to-connector sealing and device locking designs are critical

DuraGard® Waterproof Connections

Washdown Duty, Chemical, Outdoor, Industrial and Marine Use Non-Metallic Plugs, Connectors Receptacles and Inlets — 20, 30, 50 and 60 Amp, Maximum 600VAC/250VDC

DuraGard® Pin and Sleeve Connections

Pin and Sleeve contact devices consist of round male pins that are inserted into tubular female sleeves. Current flows through a large pin-to-sleeve circular contact area. Because current is not restricted through point contact only, higher current flow and cooler operating temperatures are achieved in a compact connection. Wiping action during insertion or withdrawal provides positive self cleaning. Shrouded pins and sleeves are protected from physical damage or casual access and aid in polarization features of the line. The shroud and screw collar completely lock plugs to receptacles or connectors for a reliable connection. Step on the cord, kick or drop a plug — your connection will remain tight. **Pin and Sleeve devices are the safety standard for high-current applications worldwide.**

Bladed Plug and Receptacle

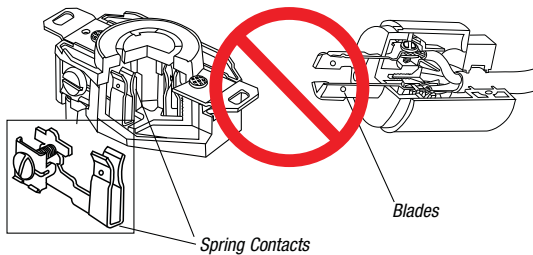

Spring blade contact designs offer point contact only, with minimal mechanical support in receptacles. Higher heat is generated in use as contacts loosen with age and dirt accumulation, resulting in failures. Exposed blade contacts can easily be damaged. Contacts are both the electrical and mechanical locking method.

Pin and Sleeve Connector and Plug

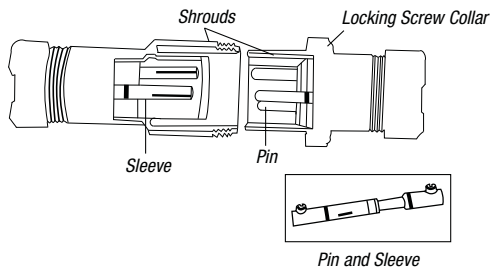

Pin and Sleeve design enables higher current flow at cooler temperatures due to large circular contact area. Sleeves act as retainers for the pins, making a reliable connection. Shrouded pins and sleeves are protected from damage and inadvertent access. Locking housing screw collars provide for a reliable, long-lasting connection with electrical contacts separate.



The Water Spray Test

1000-PSI water spray was directly applied at the face of DuraGard® receptacles. No damage occurred, and no water penetrated the housing or cord seal. DuraGard® plugs, connectors and receptacles are designed to withstand water spray test at 1000 PSI. No extra boots or adapters required.

DuraGard®: Designed for the Toughest Washdown Applications



Pulp and Paper



Food Processing



Beverage and Bottling



Pharmaceutical Manufacturing

DuraGard® Waterproof Connections

Washdown Duty, Chemical, Outdoor, Industrial and Marine Use Non-Metallic Plugs, Connectors Receptacles and Inlets — 20, 30, 50 and 60 Amp, Maximum 600VAC/250VDC

The Ultimate in Waterproof Connections

20, 30, 50 and 60 Amp, 600VAC
20 Amp, 250VDC

Lockout Capable (30/50/60A Plugs):

- Access hole (not seen) for padlock hasp
- Interlock engagement CDA 360 solid brass pin and sleeve contacts

High Reliability, High-Performance Connections:

- CDA 360 solid brass pin and sleeve contacts

Long-Lasting Self-Cleaning Connections:

- Full round pin and sleeve contacts

Fast, Easy, Rear-Load Wiring and Assembly:

- Drop-in assembly interior
- Sleeve and cable bushing
- Easy-in pressure screw wiring terminations

Waterproof Cable Sealing:

- Neoprene compression bushing cable locking system
- Locking bushing nut with external cable clamps
- Bushing sizes available for any cable size

Waterproof Locking Connections:

- Locking screw collars with O-ring gaskets
- Housing mechanical support and pin and sleeve connection

Safety Specified Voltage Connections:

- Safety ground makes first breaks last
- Voltage polarized to meet NEC® 210-7 and OSHA standards

Durable and UL® 94-V0 Flame Rated Housings:

- DuraV® high-impact body and collars
- Thermoset interiors
- Deadfront construction

Dry Wiring Compartments:

- DurOring™ Sealing System for each pin and sleeve and interior assembly

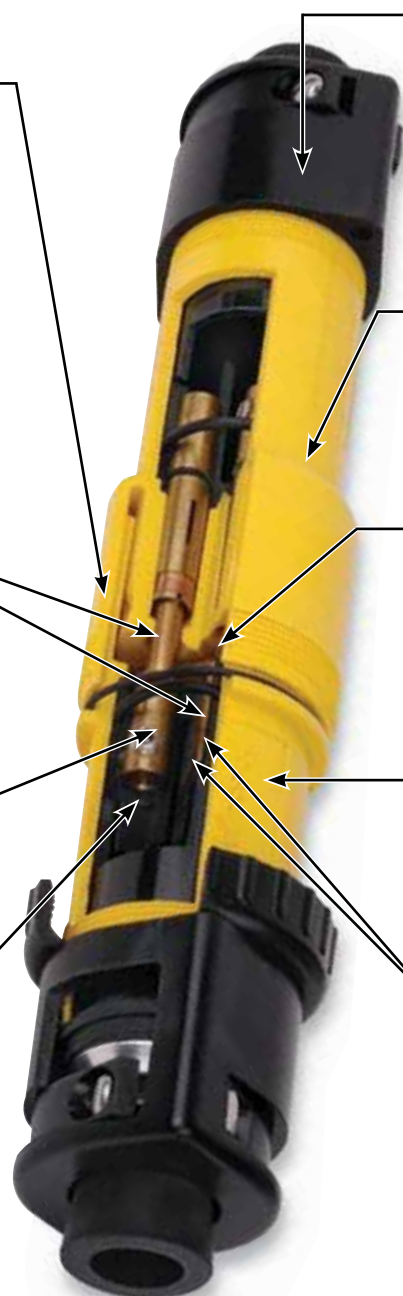

(50-Amp Plug and Connector Shown)

NEC and National Electrical Code are registered trademarks of the National Fire Protection Association, Inc.

DuraGard® Waterproof Connections

20 Amp Standard Service

Russellstoll® Pin and Sleeve Power Connectors



Male Plug



Female Connector

Device Ratings and Polarizations

Maximum 600VAC or 250VDC

POLE	WIRE	SAFETY POLARIZATION (RECEPTACLE)	VOLTAGE	CAT. NO.	CAT. NO.
2	3		125VAC	9P23U1	9C23U1
			250VAC	9P23U2	9C23U2
			277VAC	9P23U3	9C23U3
			480VAC	9P23U4	9C23U4
			600VAC	9P23U5	9C23U5
			through 600VAC/250VDC	9P23U0	9C23U0
3	4		125/250VAC	9P24U1	9C24U1
			3Ø 250VAC	9P24U2	9C24U2
			3Ø 480VAC	9P24U4	9C24U4
			3Ø 600VAC	9P24U5	9C24U5
			through 600VAC/250VDC	9P24U0	9C24U0

□ Add suffix — / xxx for bushing I.D. (page 65) or conduit adapter assembled.

◆ "W" suffix is watertight; "F" suffix for splash-proof spring flap cover.

* Consult Technical Services.

DuraGard® Waterproof Connections



Female Receptacle

STANDARD BUSHING I.D.: PLUG/CONN.*	CAT. NO. <input type="checkbox"/>
Standard .625"; or optional size, see page 65	9R23U1W
	9R23U2W
	9R23U3W
	9R23U4W
	9R23U5W
	9R23U0W
Standard .625"; or optional size, see page 65	9R24U1W
	9R24U2W
	9R24U4W
	9R24U5W
	9R24U0W

Add suffix — / xxxx for bushing I.D. (**page 65**) or conduit adapter assembled.

◆ "W" suffix is watertight; "F" suffix for splash-proof spring flap cover.

* Consult Technical Services.

DuraGard® Waterproof Connections

30 Amp Standard Service



Male Plug



Female Connector

Device Ratings and Polarizations

Maximum 600VAC or 250VDC

POLE	WIRE	SAFETY POLARIZATION (RECEPTACLE)	VOLTAGE	CAT. NO. <input type="checkbox"/>	CAT. NO. <input type="checkbox"/>
2	3		125VAC	9P33U1	9C33U1
			250VAC	9P33U2	9C33U2
			277VAC	9P33U3	9C33U3
			480VAC	9P33U4	9C33U4
			600VAC	9P33U5	9C33U5
			through 600VAC/250VDC	9P33U0	9C33U0
3	4		125/250VAC	9P34U1	9C34U1
			3Ø 250VAC	9P34U2	9C34U2
			3Ø 480VAC	9P34U4	9C34U4
			3Ø 600VAC	9P34U5	9C34U5
			through 600VAC/250VDC	9P34U0	9C34U0

Add suffix — / xxx for bushing I.D. (page 65) or conduit adapter assembled.

◆ "W" suffix indicates watertight receptacle;

"F" suffix indicates splash-proof spring flap cover included.

* Consult Technical Services.

DuraGard® Waterproof Connections

30 Amp Reverse Service



Female Receptacle



Female Plug



Male Receptacle

Russellstoll® Pin and Sleeve Power Connectors

STANDARD BUSHING I.D.: PLUG/CONN.*	CAT. NO. ♦	CAT. NO. □	CAT. NO. ♦
Standard .700"; for optional size, see page 65	9R33U1W	9F33U1	9B33U1F
	9R33U2W	9F33U2	9B33U2F
	9R33U3W	9F33U3	9B33U3F
	9R33U4W	9F33U4	9B33U4F
	9R33U5W	9F33U5	9B33U5F
	9R33U0W	9F33U0	9B33U0F
Standard .750"; for optional size, see page 65	9R34U1W	9F34U1	9B34U1F
	9R34U2W	9F34U2	9B34U2F
	9R34U4W	9F34U4	9B34U4F
	9R34U5W	9F34U5	9B34U5F
	9R34U0W	9F34U0	9B34U0F

□ Add suffix — / xxx for bushing I.D. (**page 65**) or conduit adapter assembled.

♦ "W" suffix indicates watertight receptacle;
"F" suffix indicates splash-proof spring flap cover included.

* Consult Technical Services.

DuraGard® Waterproof Connections

50 Amp Standard Service



Male Plug

Female Connector

Device Ratings and Polarizations

Maximum 600VAC or 250VDC

POLE	WIRE	SAFETY POLARIZATION (RECEPTACLE)	VOLTAGE	CAT. NO. <input type="checkbox"/>	CAT. NO. <input type="checkbox"/>
2	3		125VAC	9P53U1	9C53U1
			250VAC	9P53U2	9C53U2
			277VAC	9P53U3	9C53U3
			480VAC	9P53U4	9C53U4
			600VAC	9P53U5	9C53U5
			through 600VAC/250VDC	9P53U0	9C53U0
3	4		125/250VAC	9P54U1	9C54U1
			3Ø 250VAC	9P54U2	9C54U2
			3Ø 480VAC	9P54U4	9C54U4
			3Ø 600VAC	9P54U5	9C54U5
			through 600VAC/250VDC	9P54U0	9C54U0

Add suffix — / xxxx for bushing I.D. (page 65) or conduit adapter assembled.

◆ "W" suffix is watertight; "F" suffix for splash-proof spring flap cover.

DuraGard® Waterproof Connections

50 Amp Reverse Service



Female Receptacle



Female Plug



Male Receptacle

STANDARD BUSHING I.D.: PLUG/CONN.*	◆ CAT. NO.	□ CAT. NO.	◆ CAT. NO.
Standard .925"; for optional size, see page 65	9R53U1W	9F53U1	9B53U1F
	9R53U2W	9F53U2	9B53U2F
	9R53U3W	9F53U3	9B53U3F
	9R53U4W	9F53U4	9B53U4F
	9R53U5W	9F53U5	9B53U5F
	9R53U0W	9F53U0	9B53U0F
Standard .925"; For optional size, see page 65	9R54U1W	9F54U1	9B54U1F
	9R54U2W	9F54U2	9B54U2F
	9R54U4W	9F54U4	9B54U4F
	9R54U5W	9F54U5	9B54U5F
	9R54U0W	9F54U0	9B54U0F

□ Add suffix — / xxx for bushing I.D. (**page 65**) or conduit adapter assembled.

◆ "W" suffix is watertight; "F" suffix for splash-proof spring flap cover.

* Consult Technical Services.

DuraGard® Waterproof Connections

60 Amp Standard Service



Male Plug

Female Connector

Device Ratings and Polarizations

Maximum 600VAC or 250VDC

POLE	WIRE	SAFETY POLARIZATION (RECEPTACLE)	VOLTAGE	CAT. NO. <input type="checkbox"/>	CAT. NO. <input type="checkbox"/>
2	3		125VAC	9P63U1	9C63U1
			250VAC	9P63U2	9C63U2
3	4		125/250VAC	9P64U1	9C64U1
			3Ø 250VAC	9P64U2	9C64U2

Add suffix — / xxxx for bushing I.D. (page 65) or conduit adapter assembled.

◆ "W" suffix is watertight; "F" suffix for splash-proof spring flap cover.

60 Amp Reverse Service



Female Receptacle

Female Plug

Male Receptacle

STANDARD BUSHING I.D.: PLUG/CONN.*	CAT. NO. <input type="checkbox"/>	CAT. NO. <input type="checkbox"/>	CAT. NO. <input type="checkbox"/>
Standard 1.000"; for optional size, see page 65	9R63U1	9F63U1	9B63U1
	9R63U2	9F63U2	9B63U2
Standard 1.000"; for optional size, see page 65	9R64U1	9F64U1	9B64U1
	9R64U2	9F64U2	9B64U2

Add suffix — / xxxx for bushing I.D. (page 65) or conduit adapter assembled.

◆ "W" suffix is watertight; "F" suffix for splash-proof spring flap cover.

* Consult Technical Services.

DuraGard® Waterproof Connections

Conduit Boxes (For Surface Mounting)

Type FD

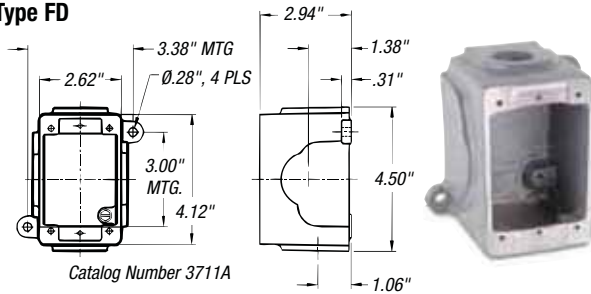

Catalog Number 3711A

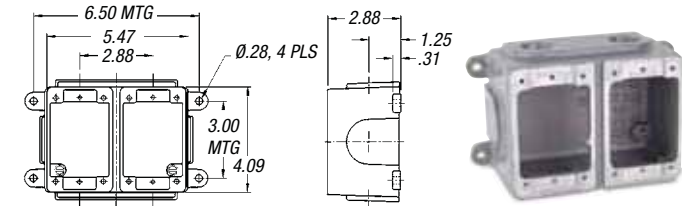

Catalog Number 3712A

	CAST ALUMINUM	CAST BRASS	USE WITH
Single	3711A	3731-RS	20A
Double	3712A	3732-RS	30A
DSFD	3781A	—	50A

Note: 3/4" NPT Hole Std. Additional accessories are available. Please consult your Thomas & Betts representative.

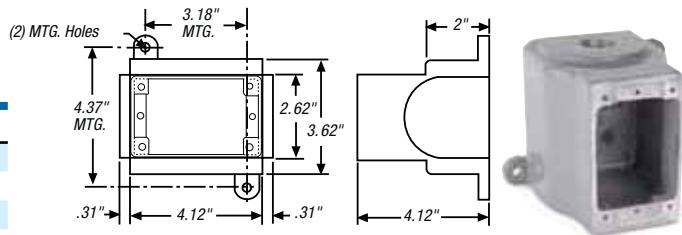

Catalog Number 3781A

45° Angle Adapter

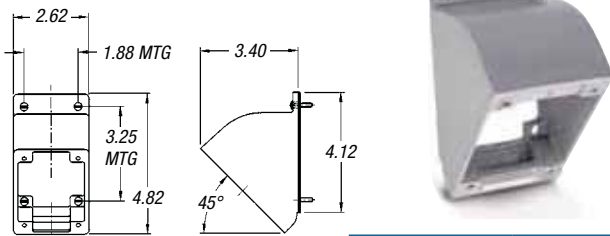

Catalog Number 3678A

	CAST ALUMINUM	CAST BRASS
	3678A	3678B

Conduit Adapter Kits (Plugs or Connectors)



SIZE	20 AMP	30 AMP	50 AMP	60 AMP
1/2"	9X2C50	9X3C50	—	—
3/4"	9X2C75	9X3C75	9X5C75	9X6C75
1"	—	9X3C10	9X5C10	9X6C10

Cable Bushings



20-Amp Cable Bushing

MAX. CABLE O.D. (INCHES)	20 AMP	30, 50 & 60 AMP
.375	C16984A	—
.437	C16984B	—
.500	C16984C	—
.545	—	2000-11
.562	C16984D	—
.606	B16506	—
.620	—	2000-03
.625	B16524	—
.700	—	2000-04
.750	—	2000-01
.800	—	2000-06
.870	—	2000-02
.925	—	2000-12
1.000	—	2000-05

(Minimum limit 85% of O.D. size for sealing.)
Material — Oil-resistant Neoprene.
State catalog number followed by slash (/) and Max. Cable O.D.; example: 9P33U1/1000 will order the 1.000" bushing instead of the standard .700" bushing for the 9P33U1.

Replacement Caps



	20 AMP	30 AMP	50 AMP	60 AMP
Screw Cap (Connector)	9X2PSC	9X3PSC	9X5PSC	9X6PSC
Cup Cap (Plug)	—	9X3CC	9X3CC	9X3CC
Screw Cap (Receptacle)	—	7X3RCW	7X5RCW	7X6RCW
Flap Cap (Receptacle)	—	7X3RCF	7X5RCF	7X6RCF

Russellstoll® Pin and Sleeve Power Connectors

DuraGard® Waterproof Connections

Replacement Interiors



Russellstoll® Pin and Sleeve Power Connectors

AMPS	VOLTAGE POLARIZATION	CAT. NO.	
		MALE INTERIOR ASSEMBLY	FEMALE INTERIOR ASSEMBLY
2P3W 20A	125VAC	9XM23U1	9XF23U1
	250VAC	9XM23U2	9XF23U2
	277VAC	9XM23U3	9XF23U3
	480VAC	9XM23U4	9XF23U4
	600VAC	9XM23U5	9XF23U5
	through 600VAC/250VDC	9XM23U0	9XF23U0
2P3W 30A	125VAC	9XM33U1	9XF33U1
	250VAC	9XM33U2	9XF33U2
	277VAC	9XM33U3	9XF33U3
	480VAC	9XM33U4	9XF33U4
	600VAC	9XM33U5	9XF33U5
	through 600VAC/250VDC	9XM33U0	9XF33U0
2P3W 50A	125VAC	9XM53U1	9XF53U1
	250VAC	9XM53U2	9XF53U2
	480VAC	9XM53U4	9XF53U4
	600VAC	9XM53U5	9XF53U5
	through 600VAC/250VDC	9XM53U0	9XF53U0
	3P4W 20A	125/250VAC	9XM24U1
3Ø 250VAC		9XM24U2	9XF24U2
3Ø 480VAC		9XM24U4	9XF24U4
3Ø 600VAC		9XM24U5	9XF24U5
through 600VAC/250VDC		9XM24U0	9XF24U0
3P4W 30A		125/250VAC	9XM34U1
	3Ø 250VAC	9XM34U2	9XF34U2
	3Ø 480VAC	9XM34U4	9XF34U4
	3Ø 600VAC	9XM34U5	9XF34U5
	through 600VAC/250VDC	9XM34U0	9XF34U0
	3P4W 50A	125/250VAC	9XM54U1
3Ø 250VAC		9XM54U2	9XF54U2
3Ø 480VAC		9XM54U4	9XF54U4
3Ø 600VAC		9XM54U5	9XF54U5
through 600VAC/250VDC		9XM54U0	9XF54U0
2P3W 60A		125VAC	9XM63U1
	250VAC	9XM63U2	9XF63U2
3P4W 60A	125/250VAC	9XM64U1	9XF64U1
	3Ø 250VAC	9XM64U2	9XF64U2

DuraGard® Waterproof Connections

Safety Interlocks

Circuit Breaker Interlocked Outlet:

- 30A and 50A ranges and polarizations to 480VAC
- 22kA interrupt capacity breaker
- Easy handle reset after trip
- Auxiliary switch or other options

User Friendly — Flexible Mounting:

- Variable footprint mounting tabs
- Compact size fits 8" standard I-beam webs
- Conduit entry from top, bottom or side (¾", 1" or 1¼" NPT)
- Large red handle with lockout access

Flame Rated and DuraV® Tough Housing:

- UL® 94-V0 housing and interior with stainless steel components
- High-impact thermoplastic housing
- NEMA 4X construction



Russellstoll® Pin and Sleeve Power Connectors

The **only** non-metallic, 22kAIC, 30A and 50A series circuit breaker interlocked receptacle available today!

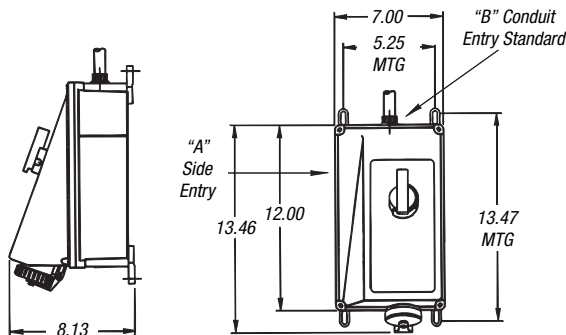

3P4W EXAMPLES SHOWN:				CAT. NO.		
AMPS	VOLTAGE POLARIZATION	SAFETY INTERLOCK WITH CIRCUIT BREAKER	CIRCUIT BREAKER TRIP RATING	MATING PLUG	ROTARY CONTROLLER	REPLACEMENT INTERIOR
3P4W 30A	125/250VAC	9MT34U1W30B	30A	9P34U1	9MI34U1WNAB	9XL34U1
	3Ø 250VAC	9MT34U2W30B	30A	9P34U2	9MI34U2WNAB	9XL34U2
	3Ø 480VAC	9MT34U4W30B	30A	9P34U4	9MI34U4WNAB	9XL34U4
	3Ø 600VAC	9MT34U5W30B	30A	9P34U5	9MI34U5WNAB	9XL34U5
	through 600VAC/3P4W	9MT34U0W30B	30A	9P34U0	9MI34U0WNAB	9XL34U0
	3P4W 50A	125/250VAC	9MT54U1W50B	50A	9P54U1	9MI54U1WNAB
3Ø 250VAC		9MT54U2W50B	50A	9P54U2	9MI54U2WNAB	9XL54U2
3Ø 480VAC		9MT54U4W50B	50A	9P54U4	9MI54U4WNAB	9XL54U4
3Ø 600VAC		9MT54U5W50B	50A	9P54U5	9MI54U5WNAB	9XL54U5
through 600VAC/3P4W		9MT54U0W50B	50A	9P54U0	9MI54U0WNAB	9XL54U0

Note: 1. Change suffix for alternate trip ratings. Example: 9MT54U2W30B — 50-amp, 3P4W, safety interlock with 30-amp circuit breaker, conduit top entry.

◆ Change "W" to "F" for flap cap access. Example: 9MI34U2F30B — 30-amp, 3P4W, safety interlock with rotary controller and flap cap.

(Minimum limit 85% of O.D. size for sealing.)

Foot and Hardware Replacement Kit: Cat. No. 9XLMF (non-metallic) and Cat. No. 9XLMF-SS (stainless steel).

DuraGard® Waterproof Connections

Plugs and Female Plugs

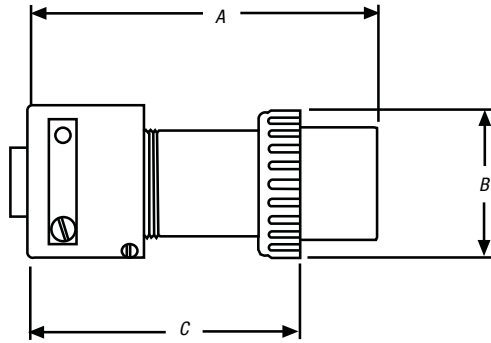

Connectors

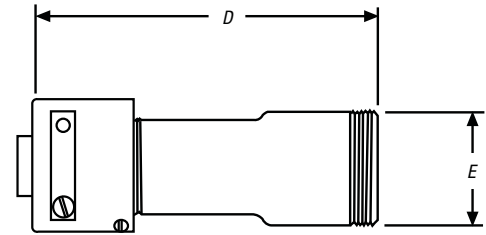

AMPS		A*	B	C*	D	E	MAX AWG	TERMINAL Ø IN./MM
20A	Inches	3.87	2.16	2.75	4.75	1.88	12	.140/.0055
	mm	98.3	54.9	69.9	120.7	47.8		
30A	Inches	5.385	2.38	4.16	6.25	2.13	8	.235/.0092
	mm	136.6	60.5	105.7	158.8	54.1		
50A	Inches	5.75	2.38	4.16	6.25	2.13	6	.235/.0092
	mm	146.1	60.5	105.7	158.8	54.1		
60A	Inches	5.75	2.38	4.16	6.25	2.13	6	.235/.0092
	mm	146.1	60.5	105.7	158.8	54.1		

* Dimensions will vary slightly with assembly.

Receptacles and Male Receptacles

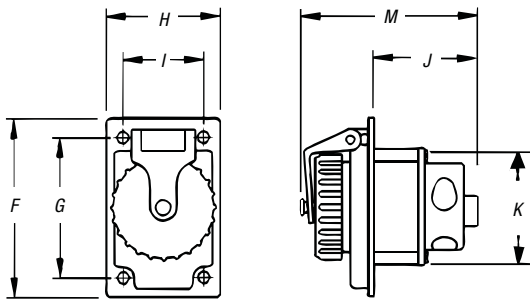

Screw cover shown. Flap cover also available; no dimensional changes.

AMPS		F	G	H	I	J	K	M	MAX. AWG	TERMINAL Ø IN./MM
20A	Inches	4.14	3.25	2.66	1.88	1.49	2.26	3.17	12	.140/.0055
	mm	105.2	82.6	67.6	47.8	37.8	57.4	80.5		
30A	Inches	4.14	3.25	2.66	1.88	2.44	2.71	4.12	8	.235/.0092
	mm	105.2	82.6	67.6	47.8	62.0	68.8	104.6		
50A	Inches	4.14	3.25	2.66	1.88	2.44	2.71	4.12	6	.235/.0092
	mm	105.2	82.6	67.6	47.8	62.0	68.8	104.6		
60A	Inches	4.14	3.25	2.66	1.88	2.44	2.71	4.12	6	.235/.0092
	mm	105.2	82.6	67.6	47.8	62.0	68.8	104.6		

DuraGard® Waterproof Connections

Plugs, Connectors and Receptacles

Performance — Electrical

Dielectric Voltage Withstand	3000 volts
Max. Working Voltage	6000 volts RMS (minimum creepage and minimum clearance per UL 840)
Circuit Interrupting/ Load Breaking	UL® Listed and CSA Certified for circuit interrupting at full rated current
Temperature Rise	Max. 30° C/86° F temperature rise at full rated current after 50 cycles of overload at 150% rated current at .75 pf

Performance — Mechanical

Impact Resistance	Per UL 1682 Paragraph 34
Cord Accommodation	Round portable service cords. 10 standard diameters from .405" to 1.00", custom sizes to spec
Terminal Identification	In accordance with UL 1682
Cable Pull Out Force	In accordance with UL 1682
Product Identification	Identification label and molded in name
Lockout/Tagout	Lockout/tagout hole on plug complies with OSHA Reg. 29 CFR 1910.147

Performance — Environmental

Moisture Resistance	Per UL 1682 Paragraph 49 Watertight/ flap screw cover on receptacle, O-rings on all pins and sleeves, interiors and plug shell. Watertight even when not engaged
Flammability	VO or better per UL 94
Operating Temperatures	Maximum continuous: 95° C/203° F Minimum: -40° C/-40° F without impact
Chemicals	Resists standard industrial hydrocarbons, acids, bases and solvents



Material

Contact Carrier Interior	Molded arc-resistant UL 94-V0 phenolic thermoset
Housing, Gland Nuts, Screw Collar Rings	DuraV® UL 94-V0, high-impact Thermoplastic
O-Rings	Buna-N (Nitrile)
Contacts: Pins and Sleeves	Brass CDA 360
Hinge Pins (Receptacle)	Stainless steel
Terminals	Brass CDA 360
Terminal Screws, Flap Springs, Assembly Screws, Nuts, Hardware	Stainless steel
Gland Friction Washer	20 amp — Nylon 30, 50 and 60 amp — Aluminum
Cable Clamp Bushing	Neoprene

Approvals*



* TUV & PSE listed product also available; contact Technical Services.

DuraGard® Waterproof Connections

Safety Interlocks

Performance — Electrical

Dielectric Voltage Withstand	3000 volts
Max. Working Voltage	480 volts RMS (minimum creepage distance and minimum clearance per UL® 840) (using circuit breaker)
Circuit Interrupting/ Load Breaking	UL Listed and CSA Certified for circuit interrupting at full rated current
Temperature Rise	Max. 30° C/86° F temperature rise at full rated current after 50 cycles of overload at 150% rated current at .75 pf
Shrouded Contacts	Complies with California Code Title 8, Art. 51, S2510.7(b) for devices exceeding 300VAC

Performance — Mechanical

Impact Resistance	Per UL 1682 Paragraph 34
Wiring Accommodation	Conduit entries at top, side and bottom, .750" NPT top entry standard
Terminal Identification	In accordance with UL 1682
Plug Pull Out Force	In accordance with UL 1682
Product Identification	Identification label
Lockout/Tagout	Lockout/tagout access on switch complies with OSHA Reg. 29 CFR 1910.147

Performance — Environmental

Moisture Resistance	Per UL 1682 Paragraph 49. Watertight/ flap screw cover on receptacle, O-rings on all pins and sleeves, interiors and plug shell. Watertight even when not engaged (screw cover closed/locked)
Flammability	V0 or better per UL 94
Operating Temperatures	Maximum continuous: 95° C/203° F Minimum: -40° C /-40° F without impact (Note: per C/B trip at elevated temps.)
Chemicals	Resists standard industrial hydrocarbons, acids, bases and solvents
UV Resistance	UV-stabilized material

Material

Contact Carrier Interior	Molded arc-resistant UL 94-V0 thermoset material
Housing, Gland Nuts, Screw Collar Rings	DuraV® UL 94-V0, high-impact Thermoplastic
O-Rings	Buna-N (Nitrile)
Contacts: Pins and Sleeves	Brass CDA 360
Hinge Pins (Receptacle)	Stainless steel
Terminals	Brass CDA 360
Terminal Screws, Flap Springs, Assembly Screws, Nuts, Hardware	Stainless steel
Gland Friction Washer	20 amp — Nylon 30, 50 and 60 amp — Aluminum
Cable Clamp Bushing	Neoprene

Approvals



ABB IEC 60 309 International Pin and Sleeve

In this section...



ABB IEC 60 309 International Pin and Sleeve

Overview	72–75
IP67 Pin and Sleeve Plugs & Connectors	76–78
IP67 Mechanical Interlocks	79
Accessories	80
Technical Data	81
Dimensions.....	82–83
Specifications	84–85

Thomas&Betts

A Member of the ABB Group

ABB IEC 60 309 International Pin and Sleeve

Approved According to IEC 60 309-1, -2, -4 — Range from 16 up to 125 Amp, up to 600V, IP67 (Watertight)



Safety

- **Proven performance:** With more than 30 years of experience, ABB IEC Pin and Sleeve Connectors are the brand of choice around the globe
- **Added safety measures:** Plugs and connectors are equipped with a double cable clamp system to prevent cable detachment and provide a higher level of cable strain relief
- **Safe connections:** Mechanical interlocks guarantee no access to plug insertion or removal until power is off

Durability

- **Designed for durability:** The housings are made of thermoplastic polyester (PBT) grade Valox® 357 material, which guarantees highest possible durability in this industry
- **Lasting components:** Interconnectors are highly resistant to chemicals like mineral and organic acid, organic solvents and petroleum
- **Built to last:** All external screws are made of stainless steel to prevent corrosion
- **Reinforced for high current reliability:** The contact carrier is made of fiberglass-reinforced nylon material for sizes between 60A–125A, which reduces the need for and expense of replacement parts

Performance

- **Continuing operation:** The self-cleaning pin and sleeve design keeps the connection resistance on the lowest level, reducing down time
- **Long lasting:** Machine-calibrated sleeves with stainless steel springs provide accurate contact pressure over time
- **Resilience:** Corrosion-resistant steel screws at terminals provide clamping pressure over time
- **Easy installation:** Clear terminal markings inside and at the front of the devices



Valox is a registered trademark of SABIC.

ABB IEC 60 309 International Pin and Sleeve

IEC 60 309-2 "Clock"

$I_o = 16-125A$
 $U_o = 50-600V$

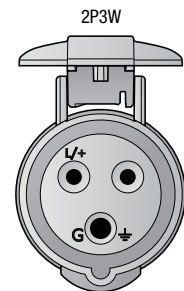
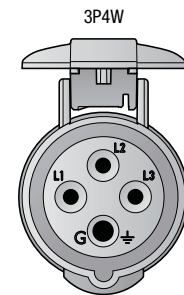
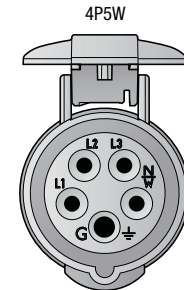
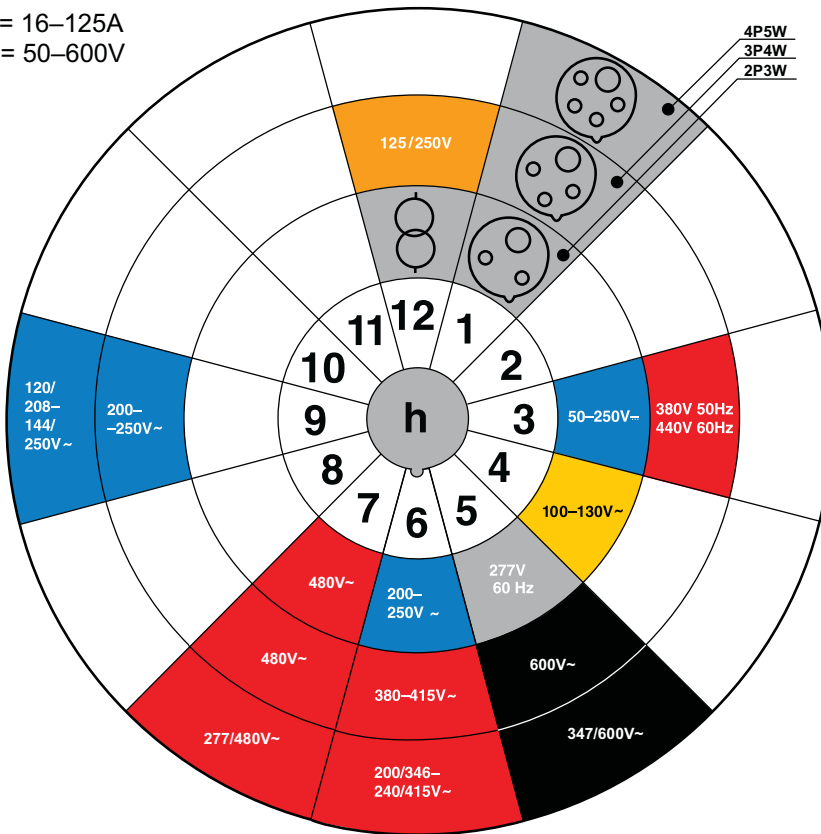

Russellstoll® Pin and Sleeve Power Connectors

Standard voltages

Color codes according to IEC 60 309-1, -2

POSITION OF EARTHING SLEEVE ACCORDING TO IEC 60309-2 (CLOCK)		2P3W	3P4W	4P5W
1	■	Optional voltage (not stated below)	■	Optional voltage (not stated below)
3	■	50-250V DC	■	380V 50 Hz to 440V 60 Hz
4	■	100-130V 50/60 Hz		
5	■	277V 60 Hz	■	600V 50/60 Hz
6	■	200-250V 50/60 Hz	■	380-415V 50/60 Hz
7	■	480V 50/60 Hz	■	480V 50/60 Hz
9			■	200-250V 50/60 Hz
12	■	Supply from isolating transformer	■	125/250V

ABB IEC 60 309 International Pin and Sleeve

Part Number Configuration

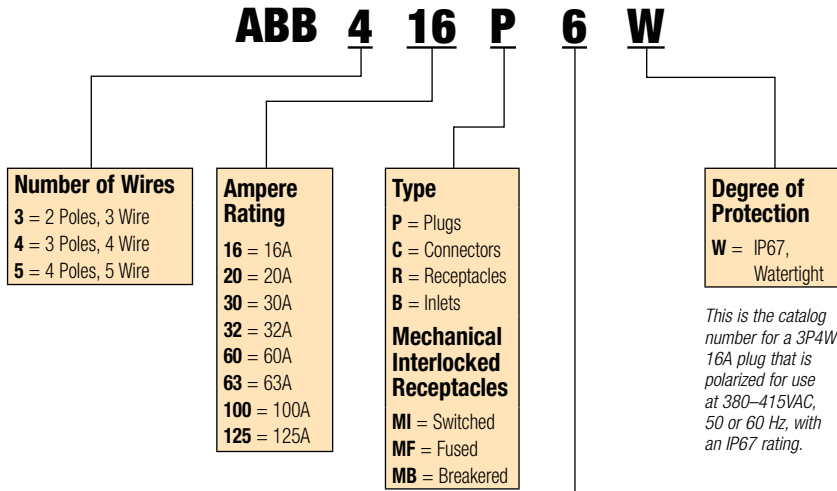

Standard voltages

Color codes according to IEC 60 309-1, -2

POSITION OF EARTHING SLEEVE ACCORDING TO IEC 60309-2 (CLOCK)		2P3W	3P4W	4P5W
1	■	Optional voltage (not stated below)	■	Optional voltage (not stated below)
3	■	50–250V DC	■	380V 50 Hz to 440V 60 Hz
4	■	100–130V 50/60 Hz		
5	■	277V 60 Hz	■	347/600V 50/60 Hz
6	■	200–250V 50/60 Hz	■	200/346–240/415V 50/60 Hz
7	■	480V 50/60 Hz	■	277/480V 50/60 Hz
9			■	120/208–144/250V 50/60 Hz
12	■	Supply from isolating transformer	■	125/250V

ABB IEC 60 309 International Pin and Sleeve

Mechanical Interlocks

Mechanical Interlocks are used in applications with high demands on safety, durability and performance. Perfect for applications with frequent connection/disconnection, and to use in public areas.

The housing is made of thermoplastic polyester (PBT) grade Valox® 357 material, which is a tough plastic that withstands heavy-duty usage and most chemicals found in industrial environments.

Features

- IP67 watertight
- 16–125A, 50–600VAC
- IEC 60 309-2, -4
- All external screws are made of stainless steel

Application examples

- Chemical industry
- Sawmills
- Airports
- Hospitals

ABB4100M16W

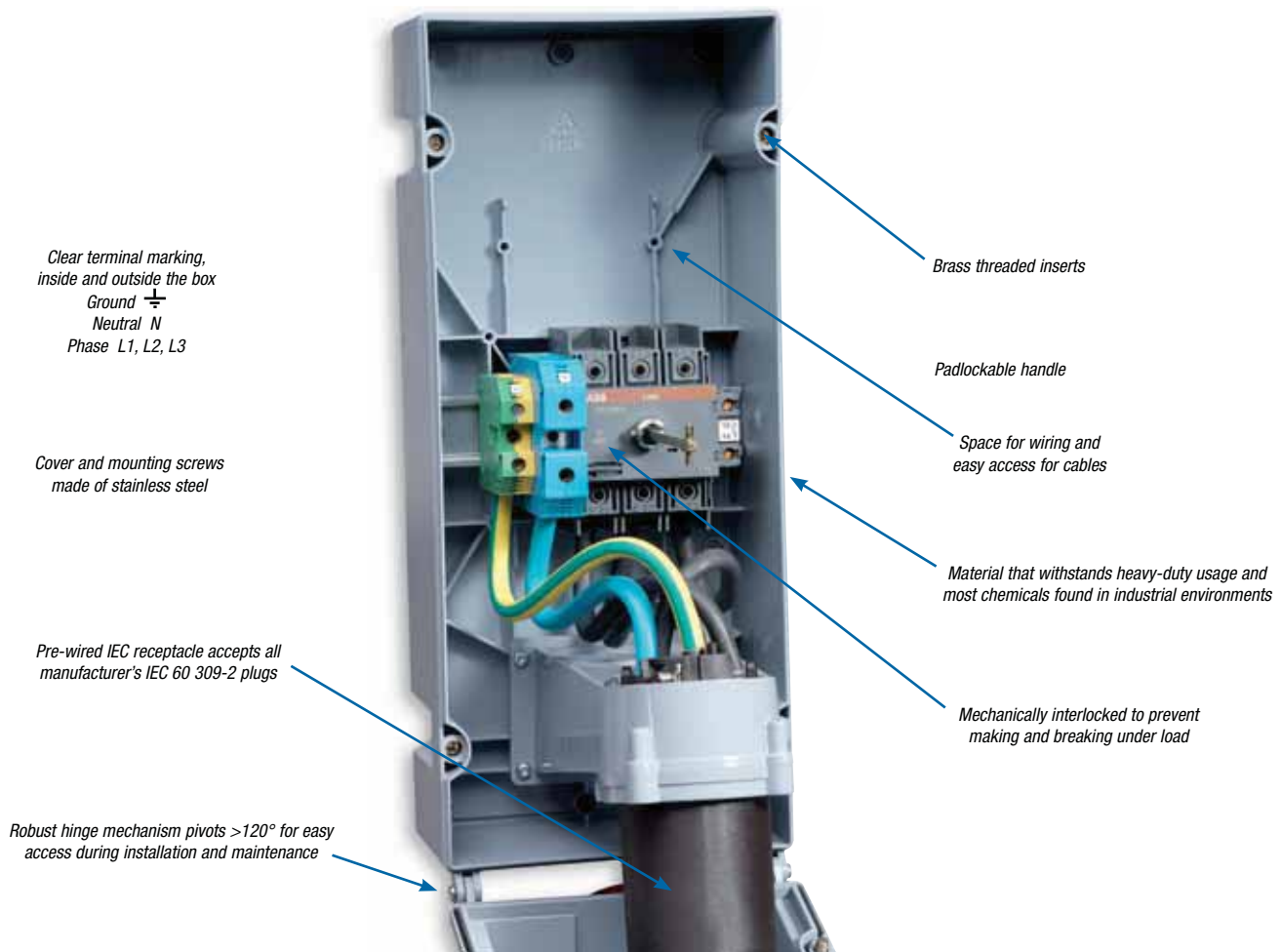

Valox is a registered trademark of SABIC.

ABB IEC 60 309 International Pin and Sleeve

Pin and Sleeve Plugs & Connectors

Pin and Sleeve Plugs & Connectors are for applications in environments that have high demand of functionality and safety. The robust housing is made of thermoplastic polyester (PBT) grade Valox® 357 material. The product is available as watertight (IP67, 16–125A). The devices are equipped with internal and external cable clamps. The 100A and 125A devices are equipped with two screws on each terminal.

Features

- IP67 watertight
- 16–125A, 50–600VAC
- IEC 60 309-1, -2
- All external screws are made of stainless steel

Application examples

- Industry/workshops
- Harbors/shipyards
- Mines
- Food & beverage

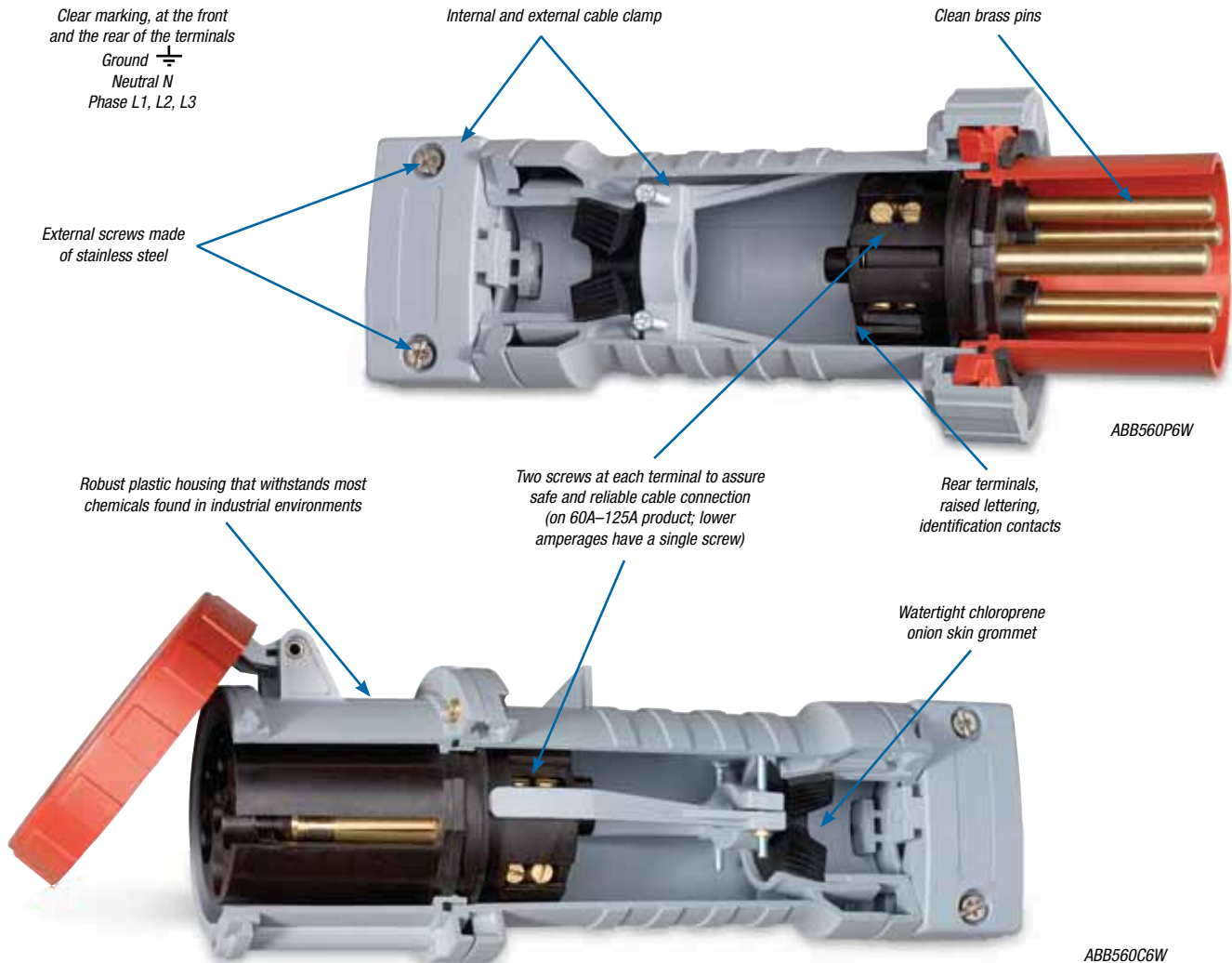

Valox is a registered trademark of SABIC.

ABB IEC 60 309 International Pin and Sleeve

IP67 Rated (Watertight)



Russellstoll® Pin and Sleeve Power Connectors

	POLES & WIRES	VOLTAGE (VAC*)	CLOCK HOUR	PLUG	CONNECTOR	RECEPTACLE	INLET	BACK BOX
16 Amp	2P3W	100–130	4h	ABB316P4W	ABB316C4W	ABB316R4W	ABB316B4W	BB 30
	2P3W	200–250	6h	ABB316P6W	ABB316C6W	ABB316R6W	ABB316B6W	BB 30
	3P4W	380–415	6h	ABB416P6W	ABB416C6W	ABB416R6W	ABB416B6W	BB 30
	4P5W	200/346–240/415	6h	ABB516P6W	ABB516C6W	ABB516R6W	ABB516B6W	BB 30
20 Amp	2P3W	100–130	4h	ABB320P4W	ABB320C4W	ABB320R4W	ABB320B4W	BB 30
	2P3W	200–250	6h	ABB320P6W	ABB320C6W	ABB320R6W	ABB320B6W	BB 30
	2P3W	277	5h	ABB320P5W	ABB320C5W	ABB320R5W	ABB320B5W	BB 30
	2P3W	480	7h	ABB320P7W	ABB320C7W	ABB320R7W	ABB320B7W	BB 30
	3P4W	125/250	12h	ABB420P12W	ABB420C12W	ABB420R12W	ABB420B12W	BB 30
	3P4W	3Ø 200–250	9h	ABB420P9W	ABB420C9W	ABB420R9W	ABB420B9W	BB 30
	3P4W	3Ø 480	7h	ABB420P7W	ABB420C7W	ABB420R7W	ABB420B7W	BB 30
	3P4W	3Ø 600	5h	ABB420P5W	ABB420C5W	ABB420R5W	ABB420B5W	BB 30
	4P5W	3ØY 120/208–144/250	9h	ABB520P9W	ABB520C9W	ABB520R9W	ABB520B9W	BB 30
	4P5W	3ØY 277/480	7h	ABB520P7W	ABB520C7W	ABB520R7W	ABB520B7W	BB 30
30 Amp	2P3W	100–130	4h	ABB330P4W	ABB330C4W	ABB330R4W	ABB330B4W	BB 30
	2P3W	200–250	6h	ABB330P6W	ABB330C6W	ABB330R6W	ABB330B6W	BB 30
	2P3W	277	5h	ABB330P5W	ABB330C5W	ABB330R5W	ABB330B5W	BB 30
	2P3W	480	7h	ABB330P7W	ABB330C7W	ABB330R7W	ABB330B7W	BB 30
	3P4W	125/250	12h	ABB430P12W	ABB430C12W	ABB430R12W	ABB430B12W	BB 30
	3P4W	3Ø 200–250	9h	ABB430P9W	ABB430C9W	ABB430R9W	ABB430B9W	BB 30
	3P4W	3Ø 480	7h	ABB430P7W	ABB430C7W	ABB430R7W	ABB430B7W	BB 30
	3P4W	3Ø 600	5h	ABB430P5W	ABB430C5W	ABB430R5W	ABB430B5W	BB 30
	4P5W	3ØY 120/208–144/250	9h	ABB530P9W	ABB530C9W	ABB530R9W	ABB530B9W	BB 30
	4P5W	3ØY 277/480	7h	ABB530P7W	ABB530C7W	ABB530R7W	ABB530B7W	BB 30
32 Amp	2P3W	100–130	4h	ABB332P4W	ABB332C4W	ABB332R4W	ABB332B4W	BB 30
	2P3W	200–250	6h	ABB332P6W	ABB332C6W	ABB332R6W	ABB332B6W	BB 30
	3P4W	380–415	6h	ABB432P6W	ABB432C6W	ABB432R6W	ABB432B6W	BB 30
	3P4W	380 50 Hz/440 60 Hz	3h	ABB432P3W	ABB432C3W	ABB432R3W	ABB432B3W	BB 30
	4P5W	200/346–240/415	6h	ABB532P6W	ABB532C6W	ABB532R6W	ABB532B6W	BB 30

* Unless otherwise noted.

ABB IEC 60 309 International Pin and Sleeve

IP67 Rated (Watertight)



	POLES & WIRES	VOLTAGE (VAC*)	CLOCK HOUR	PLUG	CONNECTOR	RECEPTACLE	INLET	BACK BOX
60 Amp	2P3W	100-130	4h	ABB360P4W	ABB360C4W	ABB360R4W	ABB360B4W	BB 60
	2P3W	200-250	6h	ABB360P6W	ABB360C6W	ABB360R6W	ABB360B6W	BB 60
	2P3W	277	5h	ABB360P5W	ABB360C5W	ABB360R5W	ABB360B5W	BB 60
	2P3W	480	7h	ABB360P7W	ABB360C7W	ABB360R7W	ABB360B7W	BB 60
	2P3W	50-250VDC	3h	ABB360P3W	ABB360C3W	ABB360R3W	ABB360B3W	BB 60
	3P4W	125/250	12h	ABB460P12W	ABB460C12W	ABB460R12W	ABB460B12W	BB 60
	3P4W	3Ø 200-250	9h	ABB460P9W	ABB460C9W	ABB460R9W	ABB460B9W	BB 60
	3P4W	3Ø 480	7h	ABB460P7W	ABB460C7W	ABB460R7W	ABB460B7W	BB 60
	3P4W	3Ø 600	5h	ABB460P5W	ABB460C5W	ABB460R5W	ABB460B5W	BB 60
	4P5W	3ØY 120/208-144/250	9h	ABB560P9W	ABB560C9W	ABB560R9W	ABB560B9W	BB 60
	4P5W	3ØY 277/480	7h	ABB560P7W	ABB560C7W	ABB560R7W	ABB560B7W	BB 60
	4P5W	3ØY 347/600	5h	ABB560P5W	ABB560C5W	ABB560R5W	ABB560B5W	BB 60
63 Amp	2P3W	200-250	6h	ABB363P6W	ABB363C6W	ABB363R6W	ABB363B6W	BB 60
	3P4W	380-415	6h	ABB463P6W	ABB463C6W	ABB463R6W	ABB463B6W	BB 60
	4P5W	200/346-240/415	6h	ABB563P6W	ABB563C6W	ABB563R6W	ABB563B6W	BB 60
100 Amp	2P3W	100-130	4h	ABB3100P4W	ABB3100C4W	ABB3100R4W	ABB3100B4W	BB 100
	2P3W	200-250	6h	ABB3100P6W	ABB3100C6W	ABB3100R6W	ABB3100B6W	BB 100
	2P3W	277	5h	ABB3100P5W	ABB3100C5W	ABB3100R5W	ABB3100B5W	BB 100
	2P3W	480	7h	ABB3100P7W	ABB3100C7W	ABB3100R7W	ABB3100B7W	BB 100
	3P4W	125/250	12h	ABB4100P12W	ABB4100C12W	ABB4100R12W	ABB4100B12W	BB 100
	3P4W	3Ø 200-250	9h	ABB4100P9W	ABB4100C9W	ABB4100R9W	ABB4100B9W	BB 100
	3P4W	3Ø 480	7h	ABB4100P7W	ABB4100C7W	ABB4100R7W	ABB4100B7W	BB 100
	3P4W	3Ø 600	5h	ABB4100P5W	ABB4100C5W	ABB4100R5W	ABB4100B5W	BB 100
	4P5W	3ØY 120/208-144/250	9h	ABB5100P9W	ABB5100C9W	ABB5100R9W	ABB5100B9W	BB 100
	4P5W	3ØY 277/480	7h	ABB5100P7W	ABB5100C7W	ABB5100R7W	ABB5100B7W	BB 100
125 Amp	4P5W	3ØY 347/600	5h	ABB5100P5W	ABB5100C5W	ABB5100R5W	ABB5100B5W	BB 100
	2P3W	200-250	6h	ABB3125P6W	ABB3125C6W	ABB3125R6W	ABB3125B6W	BB 100
	3P4W	380-415	6h	ABB4125P6W	ABB4125C6W	ABB4125R6W	ABB4125B6W	BB 100
	4P5W	200/346-240/415	6h	ABB5125P6W	ABB5125C6W	ABB5125R6W	ABB5125B6W	BB 100

* Unless otherwise noted.

ABB IEC 60 309 International Pin and Sleeve

Mechanical Interlocks IP67 Rated (Watertight)



Russellstoll® Pin and Sleeve Power Connectors

	POLES & WIRES	VOLTAGE (VAC)	CLOCK HOUR	SWITCHED	FUSED	BREAKERED	MATING PLUG
20 Amp	2P3W	200–250	6h	ABB320MI6W	N/A	N/A	ABB320P6W
	2P3W	480	7h	ABB320MI7W	N/A	N/A	ABB320P7W
	3P4W	125/250	12h	ABB420MI12W	ABB420MF12W	N/A	ABB420P12W
	3P4W	3Ø 200–250	9h	ABB420MI9W	ABB420MF9W	N/A	ABB420P9W
	3P4W	3Ø 480	7h	ABB420MI7W	ABB420MF7W	N/A	ABB420P7W
	3P4W	3Ø 600	5h	ABB420MI5W	ABB420MF5W	N/A	ABB420P5W
	4P5W	3ØY 120/208–144/250	9h	ABB520MI9W	N/A	N/A	ABB520P9W
	4P5W	3ØY 277/480	7h	ABB520MI7W	N/A	N/A	ABB520P7W
	4P5W	3ØY 347/600	5h	ABB520MI5W	N/A	N/A	ABB520P5W
30 Amp	2P3W	100–130	4h	ABB330MI4W	N/A	N/A	ABB330P4W
	2P3W	200–250	6h	ABB330MI6W	N/A	N/A	ABB330P6W
	2P3W	480	7h	ABB330MI7W	N/A	N/A	ABB330P7W
	3P4W	125/250	12h	ABB430MI12W	ABB430MF12W	N/A	ABB430P12W
	3P4W	3Ø 200–250	9h	ABB430MI9W	ABB430MF9W	N/A	ABB430P9W
	3P4W	3Ø 480	7h	ABB430MI7W	ABB430MF7W	N/A	ABB430P7W
	3P4W	3Ø 600	5h	ABB430MI5W	ABB430MF5W	N/A	ABB430P5W
	4P5W	3ØY 120/208–144/250	9h	ABB530MI9W	N/A	N/A	ABB530P9W
	4P5W	3ØY 277/480	7h	ABB530MI7W	ABB530MF7W	N/A	ABB530P7W
4P5W	3ØY 347/600	5h	ABB530MI5W	ABB530MF5W	N/A	ABB530P5W	
32 Amp	3P4W	380 50 Hz/440 60 Hz	3h	ABB432MI3W	N/A	N/A	ABB332P3W
60 Amp	2P3W	100–130	4h	ABB360MI4W	N/A	N/A	ABB360P4W
	2P3W	200–250	6h	ABB360MI6W	ABB360MF6W	N/A	ABB360P6W
	2P3W	480	7h	ABB360MI7W	N/A	N/A	ABB360P7W
	3P4W	125/250	12h	ABB460MI12W	ABB460MF12W	N/A	ABB460P12W
	3P4W	3Ø 200–250	9h	ABB460MI9W	ABB460MF9W	N/A	ABB460P9W
	3P4W	3Ø 480	7h	ABB460MI7W	ABB460MF7W	N/A	ABB460P7W
	3P4W	3Ø 600	5h	ABB460MI5W	ABB460MF5W	N/A	ABB460P5W
	4P5W	3ØY 120/208–144/250	9h	ABB560MI9W	ABB560MF9W	N/A	ABB560P9W
	4P5W	3ØY 277/480	7h	ABB560MI7W	N/A	N/A	ABB560P7W
4P5W	3ØY 347/600	5h	ABB560MI5W	N/A	N/A	ABB560P5W	
100 Amp	2P3W	100–130	4h	ABB3100MI4W	N/A	N/A	ABB3100P4W
	2P3W	200–250	6h	ABB3100MI6W	N/A	N/A	ABB3100P6W
	2P3W	480	7h	ABB3100MI7W	N/A	N/A	ABB3100P7W
	3P4W	125/250	12h	ABB4100MI12W	N/A	ABB4100MB12W	ABB4100P12W
	3P4W	3Ø 200–250	9h	ABB4100MI9W	N/A	ABB4100MB9W	ABB4100P9W
	3P4W	3Ø 480	7h	ABB4100MI7W	N/A	ABB4100MB7W	ABB4100P7W
	3P4W	3Ø 600	5h	ABB4100MI5W	N/A	N/A	ABB4100P5W
	4P5W	3ØY 120/208–144/250	9h	ABB5100MI9W	N/A	ABB5100MB9W	ABB5100P9W
	4P5W	3ØY 277/480	7h	ABB5100MI7W	N/A	ABB5100MB7W	ABB5100P7W

ABB IEC 60 309 International Pin and Sleeve

Accessories — Plugblocker

Lockout/tagout for plugs and inlets. Can be used for any IEC 60309-1 and 60309-2 plug or inlet, IP67 products.

TO FIT	CAT. NO.
Plugs 16–125A	CLF20–100
Panel Mounted Inlets 16–125A	
Surface Mounted Inlets 16–125A	



Accessories — Protective Cover 16–125A, IP67

Material in EPDM Rubber

FOR INLET AND PLUG	CAT. NO.
16A & 20A, 2P3W	ABB GP320
16A & 20A, 3P4W	ABB GP420
16A & 20A, 4P5W	ABB GP520
30A & 32A, 2P3W and 3P4W	ABB GP330/430
30A & 32A, 4P5W	ABB GP530
60A & 63A, 2P3W, 3P4W and 4P5W	ABB GP60
100A & 125A, 2P3W, 3P4W and 4P5W	ABB GP100



ABB IEC 60 309 International Pin and Sleeve

Technical Data IP67 Products

Tightening Guide

DEVICE	TERMINAL SCREWS (IN. LBS./NM)	INTERNAL CABLE CLAMP SCREWS (IN. LBS./NM)	EXTERNAL CABLE CLAMP SCREWS (IN. LBS./NM)	ASSEMBLY SCREWS (IN. LBS./NM)
16A-20A	7.1/0.8	10.6/1.2	17.7/2.0	10.6/1.2
30A-32A	10.6/1.2	10.6/1.2	17.7/2.0	10.6/1.2
60A-63A	31/3.5	10.6/1.5	26.6/3.0	10.6/1.2
100A-125A	50/5.6	17.7/2.0	26.6/3.0	17.7/2.0

Wire Sizes

DEVICE	CABLE DIMENSION RANGE (IN./MM)
16A-20A, 2P3W	0.350-0.860/9-22
16A-20A, 3P4W	0.350-0.86/9-22
16A-20A, 4P5W	0.437-1.187/11-30
30A-32A, 2P3W	0.437-1.187/11-30
30A-32A, 3P4W	0.437-1.187/11-30
30A-32A, 4P5W	0.437-1.450/11-37
60A-63A, 2P3W	0.670-1.625/17-41
60A-63A, 3P4W	0.670-1.625/17-41
60A-63A, 4P5W	0.670-1.625/17-41
100A-125A, 2P3W	0.950-1.875/24-48
100A-125A, 3P4W	0.950-1.875/24-48
100A-125A, 4P5W	0.950-1.875/24-48

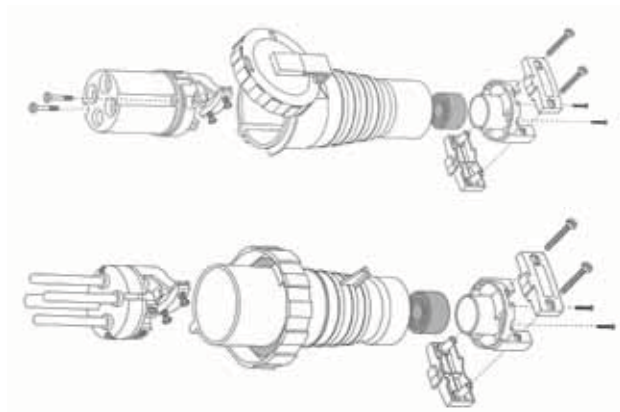

16A-32A, IP67

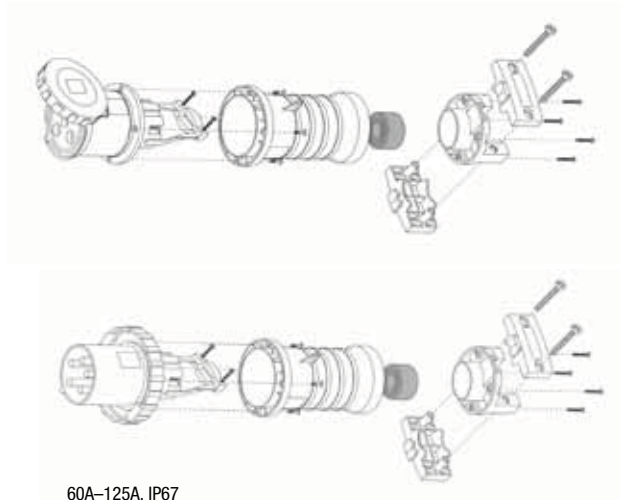

60A-125A, IP67

ABB IEC 60 309 International Pin and Sleeve

Dimensions

Plugs

TYPE	A (IN./MM)	B (IN./MM)	C (IN./MM)	D _{MAX} (IN./MM)
16A-20A, 2P3W	5.81/147.5	2.80/71	4.47/113.5	0.51/13
16A-20A, 3P4W	6.46/164	3.11/79	5.16/131	0.67/17
16A-20A, 4P5W	6.61/168	3.43/87	5.28/134	0.67/17
30A-32A, 2P3W	6.85/174	3.70/94	4.74/120.5	0.85/21.5
30A-32A, 3P4W	6.85/174	3.70/94	5.41/137.5	0.85/21.5
30A-32A, 4P5W	7.40/188	3.98/101	5.47/139	0.85/21.5
60A-63A, All	10.83/275	4.49/114	8.39/213	1.61/41
100A-125A, All	12.32/313	5.12/130	9.53/242	1.89/48

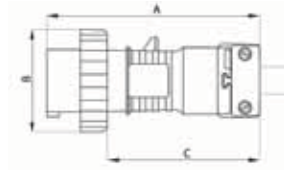

16A-32A

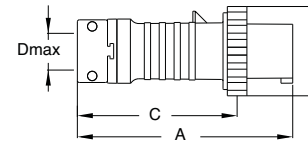

60A-125A

Connectors

TYPE	A (IN./MM)	B (IN./MM)	D _{MAX} (IN./MM)
16A-20A, 2P3W	6.73/171	3.15/80	0.51/13
16A-20A, 3P4W	7.40/188	3.46/88	0.67/17
16A-20A, 4P5W	7.68/195	3.82/97	0.67/17
30A-32A, 2P3W	7.76/197	3.94/100	0.85/21.5
30A-32A, 3P4W	7.76/197	3.94/100	0.85/21.5
30A-32A, 4P5W	8.27/210	4.29/109	0.85/21.5
60A-63A, All	11.26/286	4.37/111	1.61/41
100A-125A, All	12.80/325	4.80/122	1.89/48

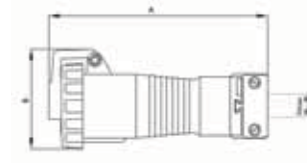

16A-32A

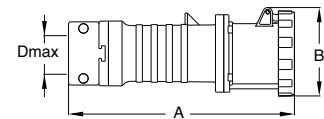

60A-125A

Receptacles

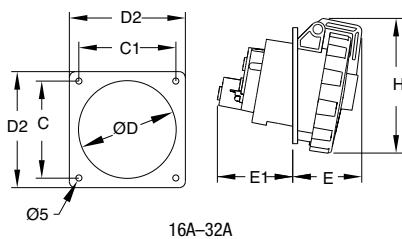

16A-32A

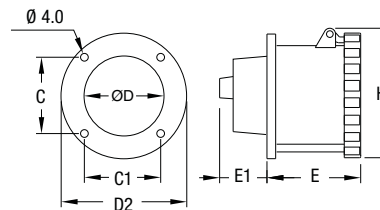

60A-63A

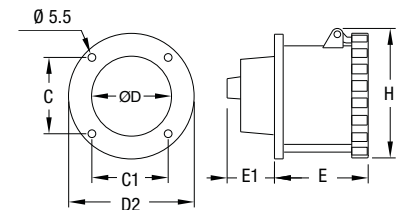

100A-125A

TYPE	C (IN./MM)	C1 (IN./MM)	D (IN./MM)	D2 (IN./MM)	E (IN./MM)	E1 (IN./MM)	H (IN./MM)
16A-20A, 2P3W	3.13/79.5	3.13/79.5	3.27/83	3.74/95	1.77/45	2.24/57	3.74/95
16A-20A, 3P4W	3.13/79.5	3.13/79.5	3.27/83	3.74/95	1.77/45	2.24/57	3.74/95
16A-20A, 4P5W	3.13/79.5	3.13/79.5	3.27/83	3.74/95	1.85/47	2.24/57	3.90/99
30A-32A, 2P3W	3.13/79.5	3.13/79.5	3.27/83	3.74/95	2.20/56	2.40/61	4.09/104
30A-32A, 3P4W	3.13/79.5	3.13/79.5	3.27/83	3.74/95	2.20/56	2.40/61	4.09/104
30A-32A, 4P5W	3.13/79.5	3.13/79.5	3.27/83	3.74/95	2.20/56	2.44/62	4.37/111
60A-63A, All	2.40/61	2.40/61	2.76/70	4.09/104	3.50/89	1.89/48	4.37/111
100A-125A, All	2.80/71	2.80/71	3.46/88	4.53/115	3.94/100	2.28/58	4.80/122

ABB IEC 60 309 International Pin and Sleeve

Dimensions

Inlets

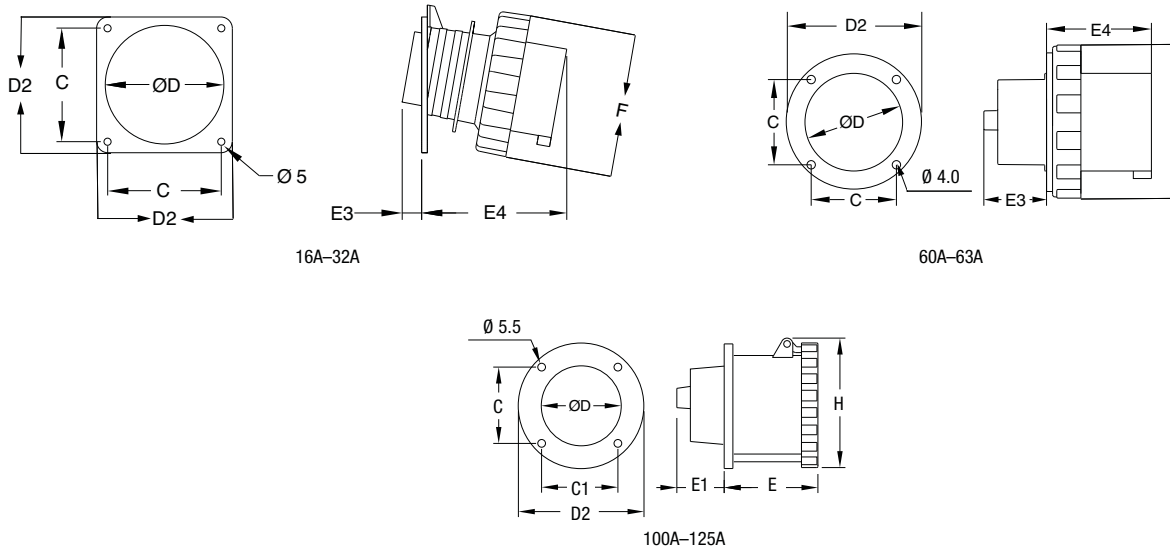

Type	C (IN./MM)	D (IN./MM)	D2 (IN./MM)	E3 (IN./MM)	E4 (IN./MM)	F (IN./MM)
16A-20A, 2P3W	3.13/79.5	3.27/83	3.74/95	0.40/10	1.85/47	2.80/71
16A-20A, 3P4W	3.13/79.5	3.27/83	3.74/95	0.40/10	2.09/53	3.11/79
16A-20A, 4P5W	3.13/79.5	3.27/83	3.74/95	0.40/10	3.43/87	3.43/87
30A-32A, 2P3W	3.13/79.5	3.27/83	3.74/95	0.47/12	2.36/60	3.70/94
30A-32A, 3P4W	3.13/79.5	3.27/83	3.74/95	0.47/12	2.36/60	3.70/94
30A-32A, 4P5W	3.13/79.5	3.27/83	3.74/95	0.47/12	2.64/67	3.98/101
60A-63A, All	4.41/112	2.40/61	2.76/70	3.86/98	1.97/50	3.15/80
100A-125A, All	4.80/122	2.80/71	3.19/81	4.65/118	2.20/56	3.50/89

Mechanical Interlocks: Switched (MI), Fused (MF) and/or Breakered (MB)



ABB IEC 60 309 International Pin and Sleeve

Plugs, Connectors, Receptacles and Inlets

Performance — Electrical

Dielectric Voltage Withstand	3000 volts for 1 minute (devices > 300V) 2000 volts for 1 minute (devices ≤ 300V)
Maximum Working Voltage	600VAC/250VDC (minimum creepage and clearances per UL 840)
Current Interrupting/ Load Breaking	Tested to 150% of full rated current for circuit interrupting
Temperature Rise	Maximum 30° C rise at full rated current after 50 cycles overload at 150% rated load at .75 pF
Endurance with Load Per IEC 60 309-1 Clause 21	20 Amp: 5000 cycles — Rated current, voltage 30 Amp: 1000 cycles — Rated current, voltage 60 Amp: 1000 cycles — Rated current, voltage 100 Amp: 250 cycles — Rated current, voltage

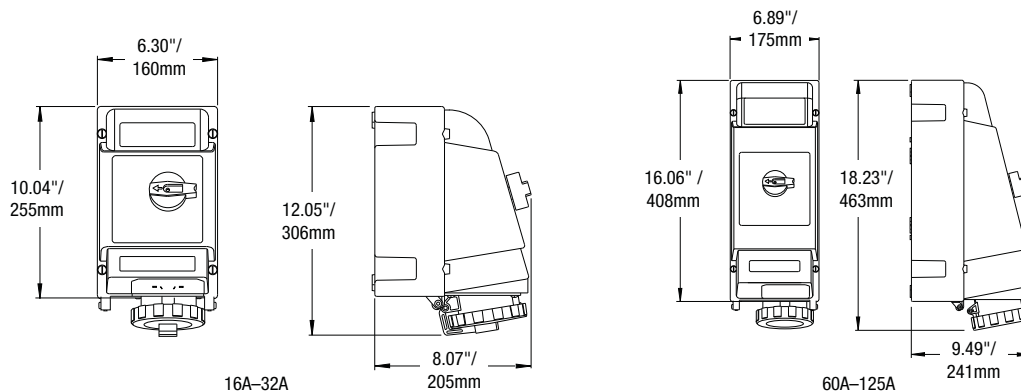
Performance — Mechanical

Cold (-25° C) Impact Resistance	Per UL 1682 Section 34 and IEC 60 309-1 Clause 24
Cable O.D. Accommodation	Round portable service cord from .57" O.D. through 1.79" O.D.
Terminal Identification	In accordance with UL 1682 standards and IEC 60 309-1: as L1-L2-L3-N-G
Cable Pull-Out Force	Per UL 1682 Section 33 and IEC 60 309-1 Clause 23
Product Identification	Product trademark(s) and UL approved product label



Performance — Environmental

Moisture Resistance	Per IEC 60 309-1; Watertight flap/screw cover on IP67 devices
Flammability	All components V2 for internal parts & V0 for external parts on 20A & 30A devices per UL94 or CSA 22.2 No. 0.6; V0 on 60A & 100A
Operating Temperatures	Maximum continuous 90° C/194° F; minimum -25° C/-13° F
Chemical Resistance	Resists standard industrial hydrocarbons, acids, bases and solvents
Corrosion Resistance	All metallic components stainless steel or brass sleeve pressure spring of stainless steel
UV Resistance	In accordance with UL® 746C

Materials

Housing	Valox®
Contact Carriers	Valox®
Cable Gland Nut	Valox®
Cable Bushing	Chloroprene, onion-ring type
O-Ring, Seals and Gaskets	Solid chloroprene
Pins & Sleeves	Brass
Sleeve Force Ring	Stainless steel
Terminal Screws	Zinc-plated steel
Flap/Screw Cover Springs	Stainless steel
Mounting Flanges	Valox®

Approvals and Compliances

1682, 1686 E109667 E109550 E163435	
60 309-1, -2, -4 LVD 2006/95/EC EMC 2004/108/EC	
C22.2 No. 182.1 LR700925	

Valox is a registered trademark of SABIC.

ABB IEC 60 309 International Pin and Sleeve

Mechanical Interlocks (Unfused/Switched, Fused and Breakered)

Performance — Electrical

Dielectric Voltage Withstand	3000 volts
Maximum Working Voltage	480 volts RMS (circuit breaker version) 600 volts RMS (switch version)
Current Interrupting	Certified for current interrupting at full rated current and voltage
Short-Circuit Current Rating Operations	10,000 RMS symmetrical amperes Mechanical: 10,000 cycles Electrical: 6000 cycles
HP Ratings (switch version)	Complies with NEC® 430-151 ratings
Circuit Breaker UL Listed	22,000 AIC
Interrupting Rating	

Performance — Mechanical

Cold (-35° C) Impact Resistance	In accordance with UL 746C
Wiring Accommodations	Suitable for metallic conduit. Conduit entry locations at enclosure top and bottom
Terminal Identification	In accordance with UL, CSA and IEC 60 309 conventions
Product Identification	Identification, ratings and color code in accordance with UL, CSA and IEC 60 309 requirements
Lockout/Tagout	"ON" and "OFF" lockout/tagout capability at switch handle. Complies with OSHA Reg. 29CFR 1910.147
Mounting	External adjustable feet



Performance — Environmental

Moisture Resistance	Screw cap version: UL Type 4X & 12K, IP67
Flammability	UL 94-5VA and V0 classifications
Operating Temperatures	Maximum continuous: 60° C (140° F) Minimum continuous: -40° C (-40° F)
UV Resistance	UV-stabilized material in accordance with UL® 746C
Chemicals	Resists most standard industrial hydrocarbons, acids, bases and solvents

Materials

Enclosure (all exterior components)	UL 94-5VA/V0, UV-stabilized, impact-modified Valox®
Contact Carrier	Molded arc-resistant UL 94-V0 thermoplastic
Gaskets	Chloroprene or EPDM
Contacts (sleeves)	Brass
Hardware (screws and springs)	Steel with zinc-plated blue chromate or nickel plating

Approvals and Compliances

UL 508 and UL 98 (switch version) UL 231 and UL 489 (circuit breaker version) UL 1682, 1686	
IEC 60 309-1, -2, -4	
CSA C22.2 No. 14, 182.1	

Catalog Number Index

CAT. NO.	PAGE NO.	CAT. NO.	PAGE NO.	CAT. NO.	PAGE NO.	CAT. NO.	PAGE NO.
2000-01	65	9C53U0	62	9P24U5	58	9R63U2	64
2000-02	65	9C53U1	62	9P33U0	60	9R64U1	64
2000-03	65	9C53U2	62	9P33U1	60	9R64U2	64
2000-04	65	9C53U3	62	9P33U2	60	9X2C50	65
2000-05	65	9C53U4	62	9P33U3	60	9X2C75	65
2000-06	65	9C53U5	62	9P33U4	60	9X2PSC	65
2000-11	65	9C54U0	62	9P33U5	60	9X3C10	65
2000-12	65	9C54U1	62	9P34U0	60	9X3C50	65
2P+G(DC)	40	9C54U2	62	9P34U0	67	9X3C75	65
310993	52	9C54U4	62	9P34U1	60	9X3CC	65
3678A	65	9C54U5	62	9P34U1	67	9X3CC	65
3678B	65	9C63U1	64	9P34U2	60	9X3CC	65
3711A	65	9C63U2	64	9P34U2	67	9X3PSC	65
3712A	65	9C64U1	64	9P34U4	60	9X5C10	65
3731-RS	65	9C64U2	64	9P34U4	67	9X5C75	65
3732-RS	65	9F33U1	61	9P34U5	60	9X5PSC	65
3781A	65	9F33U2	61	9P34U5	67	9X6C10	65
7X3RCF	65	9F33U3	61	9P53U0	62	9X6C75	65
7X3RCW	65	9F33U4	61	9P53U1	62	9X6PSC	65
7X5RCF	65	9F33U5	61	9P53U2	62	9XF23U0	66
7X5RCW	65	9F33U0	61	9P53U3	62	9XF23U1	66
7X6RCF	65	9F34U1	61	9P53U4	62	9XF23U2	66
7X6RCW	65	9F34U2	61	9P53U5	62	9XF23U3	66
9B33U1F	61	9F34U4	61	9P54U0	62	9XF23U4	66
9B33U2F	61	9F34U5	61	9P54U0	67	9XF23U5	66
9B33U3F	61	9F34U0	61	9P54U1	62	9XF24U0	66
9B33U4F	61	9F53U1	63	9P54U1	67	9XF24U1	66
9B33U5F	61	9F53U2	63	9P54U2	62	9XF24U2	66
9B33U0F	61	9F53U3	63	9P54U2	67	9XF24U4	66
9B34U1F	61	9F53U4	63	9P54U4	62	9XF24U5	66
9B34U2F	61	9F53U5	63	9P54U4	67	9XF33U0	66
9B34U4F	61	9F53U0	63	9P54U5	62	9XF33U1	66
9B34U5F	61	9F54U1	63	9P54U5	67	9XF33U2	66
9B34U0F	61	9F54U2	63	9P63U1	64	9XF33U3	66
9B53U1F	63	9F54U4	63	9P63U2	64	9XF33U4	66
9B53U2F	63	9F54U5	63	9P64U1	64	9XF33U5	66
9B53U3F	63	9F54U0	63	9P64U2	64	9XF34U0	66
9B53U4F	63	9F63U1	64	9R23U0W	59	9XF34U1	66
9B53U5F	63	9F63U2	64	9R23U1W	59	9XF34U2	66
9B53U0F	63	9F64U1	64	9R23U2W	59	9XF34U4	66
9B54U1F	63	9F64U2	64	9R23U3W	59	9XF34U5	66
9B54U2F	63	9MI34U0WNAB	67	9R23U4W	59	9XF53U0	66
9B54U4F	63	9MI34U1WNAB	67	9R23U5W	59	9XF53U1	66
9B54U5F	63	9MI34U2WNAB	67	9R24U1W	59	9XF53U2	66
9B54U0F	63	9MI34U4WNAB	67	9R24U2W	59	9XF53U4	66
9B63U1	64	9MI34U5WNAB	67	9R24U4W	59	9XF53U5	66
9B63U2	64	9MI54U0WNAB	67	9R24U5W	59	9XF54U0	66
9B64U1	64	9MI54U1WNAB	67	9R24U0W	59	9XF54U1	66
9B64U2	64	9MI54U2WNAB	67	9R33U0W	61	9XF54U2	66
9C23U0	58	9MI54U4WNAB	67	9R33U1W	61	9XF54U4	66
9C23U1	58	9MI54U5WNAB	67	9R33U2W	61	9XF54U5	66
9C23U2	58	9MT34U0W30B	67	9R33U3W	61	9XF63U1	66
9C23U3	58	9MT34U1W30B	67	9R33U4W	61	9XF63U2	66
9C23U4	58	9MT34U2W30B	67	9R33U5W	61	9XF64U1	66
9C23U5	58	9MT34U4W30B	67	9R34U1W	61	9XF64U2	66
9C24U0	58	9MT34U5W30B	67	9R34U2W	61	9XL34U0	67
9C24U1	58	9MT54U0W50B	67	9R34U4W	61	9XL34U1	67
9C24U2	58	9MT54U1W50B	67	9R34U5W	61	9XL34U2	67
9C24U4	58	9MT54U2W50B	67	9R34U0W	61	9XL34U4	67
9C24U5	58	9MT54U4W50B	67	9R53U0W	63	9XL34U5	67
9C33U0	60	9MT54U5W50B	67	9R53U1W	63	9XL54U0	67
9C33U1	60	9P23U0	58	9R53U2W	63	9XL54U1	67
9C33U2	60	9P23U1	58	9R53U3W	63	9XL54U2	67
9C33U3	60	9P23U2	58	9R53U4W	63	9XL54U4	67
9C33U4	60	9P23U3	58	9R53U5W	63	9XL54U5	67
9C33U5	60	9P23U4	58	9R54U0W	63	9XM23U0	66
9C34U0	60	9P23U5	58	9R54U1W	63	9XM23U1	66
9C34U1	60	9P24U0	58	9R54U2W	63	9XM23U2	66
9C34U2	60	9P24U1	58	9R54U4W	63	9XM23U3	66
9C34U4	60	9P24U2	58	9R54U5W	63	9XM23U4	66
9C34U5	60	9P24U4	58	9R63U1	64	9XM23U5	66

Catalog Number Index

CAT. NO.	PAGE NO.	CAT. NO.	PAGE NO.	CAT. NO.	PAGE NO.	CAT. NO.	PAGE NO.
9XM24U0	66	ABB320C7W	77	ABB363B6W	78	ABB430B9W	77
9XM24U1	66	ABB320MI6W	79	ABB363C6W	78	ABB430C12W	77
9XM24U2	66	ABB320MI7W	79	ABB363P6W	78	ABB430C5W	77
9XM24U4	66	ABB320P4W	77	ABB363R6W	78	ABB430C7W	77
9XM24U5	66	ABB320P5W	77	ABB4100B12W	78	ABB430C9W	77
9XM33U0	66	ABB320P6W	77	ABB4100B5W	78	ABB430MF12W	79
9XM33U1	66	ABB320P6W	79	ABB4100B7W	78	ABB430MF5W	79
9XM33U2	66	ABB320P7W	77	ABB4100B9W	78	ABB430MF7W	79
9XM33U3	66	ABB320P7W	79	ABB4100C12W	78	ABB430MF9W	79
9XM33U4	66	ABB320R4W	77	ABB4100C5W	78	ABB430MI12W	79
9XM33U5	66	ABB320R5W	77	ABB4100C7W	78	ABB430MI5W	79
9XM34U0	66	ABB320R6W	77	ABB4100C9W	78	ABB430MI7W	79
9XM34U1	66	ABB320R7W	77	ABB4100MB12W	79	ABB430MI9W	79
9XM34U2	66	ABB330B4W	77	ABB4100MB7W	79	ABB430P12W	77
9XM34U4	66	ABB330B5W	77	ABB4100MB9W	79	ABB430P12W	79
9XM34U5	66	ABB330B6W	77	ABB4100MI12W	79	ABB430P5W	77
9XM53U0	66	ABB330B7W	77	ABB4100MI5W	79	ABB430P5W	79
9XM53U1	66	ABB330C4W	77	ABB4100MI7W	79	ABB430P7W	77
9XM53U2	66	ABB330C5W	77	ABB4100MI9W	79	ABB430P7W	79
9XM53U4	66	ABB330C6W	77	ABB4100P12W	78	ABB430P9W	77
9XM53U5	66	ABB330C7W	77	ABB4100P12W	79	ABB430P9W	79
9XM54U0	66	ABB330MI4W	79	ABB4100P5W	78	ABB430R12W	77
9XM54U1	66	ABB330MI6W	79	ABB4100P5W	79	ABB430R5W	77
9XM54U2	66	ABB330MI7W	79	ABB4100P7W	78	ABB430R7W	77
9XM54U4	66	ABB330P4W	77	ABB4100P7W	79	ABB430R9W	77
9XM54U5	66	ABB330P4W	79	ABB4100P9W	78	ABB432B3W	77
9XM63U1	66	ABB330P5W	77	ABB4100P9W	79	ABB432B6W	77
9XM63U2	66	ABB330P6W	77	ABB4100R12W	78	ABB432C3W	77
9XM64U1	66	ABB330P6W	79	ABB4100R5W	78	ABB432C6W	77
9XM64U2	66	ABB330P7W	77	ABB4100R7W	78	ABB432MI3W	79
ABB3100B4W	78	ABB330P7W	79	ABB4100R9W	78	ABB432P3W	77
ABB3100B5W	78	ABB330R4W	77	ABB4125B6W	78	ABB432P6W	77
ABB3100B6W	78	ABB330R5W	77	ABB4125C6W	78	ABB432R3W	77
ABB3100B7W	78	ABB330R6W	77	ABB4125P6W	78	ABB432R6W	77
ABB3100C4W	78	ABB330R7W	77	ABB4125R6W	78	ABB460B12W	78
ABB3100C5W	78	ABB332B4W	77	ABB416B6W	77	ABB460B5W	78
ABB3100C6W	78	ABB332B6W	77	ABB416C6W	77	ABB460B7W	78
ABB3100C7W	78	ABB332C4W	77	ABB416P6W	77	ABB460B9W	78
ABB3100MI4W	79	ABB332C6W	77	ABB416P6W	74	ABB460C12W	78
ABB3100MI6W	79	ABB332P3W	77	ABB416R6W	77	ABB460C5W	78
ABB3100MI7W	79	ABB332P4W	77	ABB420B12W	77	ABB460C7W	78
ABB3100P4W	78	ABB332P6W	77	ABB420B5W	77	ABB460C9W	78
ABB3100P4W	79	ABB332R4W	77	ABB420B7W	77	ABB460MF12W	79
ABB3100P5W	78	ABB332R6W	77	ABB420B9W	77	ABB460MF5W	79
ABB3100P6W	78	ABB360B3W	78	ABB420C12W	77	ABB460MF7W	79
ABB3100P6W	79	ABB360B4W	78	ABB420C5W	77	ABB460MF9W	79
ABB3100P7W	78	ABB360B5W	78	ABB420C7W	77	ABB460MI12W	79
ABB3100P7W	79	ABB360B6W	78	ABB420C9W	77	ABB460MI5W	79
ABB3100R4W	78	ABB360B7W	78	ABB420MF12W	79	ABB460MI7W	79
ABB3100R5W	78	ABB360C3W	78	ABB420MF5W	79	ABB460MI9W	79
ABB3100R6W	78	ABB360C4W	78	ABB420MF7W	79	ABB460P12W	78
ABB3100R7W	78	ABB360C5W	78	ABB420MF9W	79	ABB460P12W	79
ABB3125B6W	78	ABB360C6W	78	ABB420MI12W	79	ABB460P5W	78
ABB3125C6W	78	ABB360C7W	78	ABB420MI5W	79	ABB460P5W	79
ABB3125P6W	78	ABB360MF6W	79	ABB420MI7W	79	ABB460P7W	78
ABB3125R6W	78	ABB360MI4W	79	ABB420MI9W	79	ABB460P7W	79
ABB316B4W	77	ABB360MI6W	79	ABB420P12W	77	ABB460P9W	78
ABB316B6W	77	ABB360MI7W	79	ABB420P12W	79	ABB460P9W	79
ABB316C4W	77	ABB360P3W	78	ABB420P5W	77	ABB460R12W	78
ABB316C6W	77	ABB360P4W	78	ABB420P5W	79	ABB460R5W	78
ABB316P4W	77	ABB360P4W	79	ABB420P7W	77	ABB460R7W	78
ABB316P6W	77	ABB360P5W	78	ABB420P7W	79	ABB460R9W	78
ABB316R4W	77	ABB360P6W	78	ABB420P9W	77	ABB463B6W	78
ABB316R6W	77	ABB360P6W	79	ABB420P9W	79	ABB463C6W	78
ABB320B4W	77	ABB360P7W	78	ABB420R12W	77	ABB463P6W	78
ABB320B5W	77	ABB360P7W	79	ABB420R5W	77	ABB463R6W	78
ABB320B6W	77	ABB360R3W	78	ABB420R7W	77	ABB5100B5W	78
ABB320B7W	77	ABB360R4W	78	ABB420R9W	77	ABB5100B7W	78
ABB320C4W	77	ABB360R5W	78	ABB430B12W	77	ABB5100B9W	78
ABB320C5W	77	ABB360R6W	78	ABB430B5W	77	ABB5100C5W	78
ABB320C6W	77	ABB360R7W	78	ABB430B7W	77	ABB5100C7W	78

Catalog Number Index

CAT. NO.	PAGE NO.	CAT. NO.	PAGE NO.	CAT. NO.	PAGE NO.	CAT. NO.	PAGE NO.
ABB5100C9W	78	ABB560MI7W	79	DCCA6	36	DF1404FR000	23
ABB5100MB7W	79	ABB560MI9W	79	DF1020	34	DF1407FP000	22
ABB5100MB9W	79	ABB560P5W	78	DF1022	34	DF1407FP000	24
ABB5100MI7W	79	ABB560P5W	79	DF1024	34	DF1407FRAB0	23
ABB5100MI9W	79	ABB560P7W	78	DF1026	34	DF1407FRA00	23
ABB5100P5W	78	ABB560P7W	79	DF1027	34	DF1407FR0E0	23
ABB5100P7W	78	ABB560P9W	78	DF1029	34	DF1407FR000	23
ABB5100P7W	79	ABB560P9W	79	DF1030	34	DF1414FP000	22
ABB5100P9W	78	ABB560R5W	78	DF1032	34	DF1414FP000	24
ABB5100P9W	79	ABB560R7W	78	DF1104FP000	22	DF1414FRAB0	23
ABB5100R5W	78	ABB560R9W	78	DF1104FR000	24	DF1414FRA00	23
ABB5100R7W	78	ABB563B6W	78	DF1104FRAB0	23	DF1414FR0E0	23
ABB5100R9W	78	ABB563C6W	78	DF1104FRA00	23	DF1414FR000	23
ABB5125B6W	78	ABB563P6W	78	DF1104FR0E0	23	DF1416FP000	22
ABB5125C6W	78	ABB563R6W	78	DF1104FR000	23	DF1416FP000	24
ABB5125P6W	78	ABB GP100	80	DF1107FP000	22	DF1416FRAB0	23
ABB5125R6W	78	ABB GP320	80	DF1107FP000	24	DF1416FRA00	23
ABB516B6W	77	ABB GP330/430	80	DF1107FRAB0	23	DF1416FR0E0	23
ABB516C6W	77	ABB GP420	80	DF1107FRA00	23	DF1416FR000	23
ABB516P6W	77	ABB GP520	80	DF1107FR0E0	23	DF1421FP000	22
ABB516R6W	77	ABB GP530	80	DF1107FR000	23	DF1421FR000	24
ABB520B5W	77	ABB GP60	80	DF1204FP000	22	DF1421FRAB0	23
ABB520B7W	77	B16506	65	DF1204FP000	24	DF1421FRA00	23
ABB520B9W	77	B16524	65	DF1204FRAB0	23	DF1421FR0E0	23
ABB520C5W	77	BB 100	78	DF1204FRA00	23	DF1421FR000	23
ABB520C7W	77	BB 30	77	DF1204FR0E0	23	DF1504FP000	37
ABB520C9W	77	BB 60	78	DF1204FR000	23	DF1504FP000	22
ABB520MI5W	79	C13662	52	DF1207FP000	37	DF1504FR000	24
ABB520MI7W	79	C16984A	65	DF1207FP000	22	DF1504FRAB0	23
ABB520MI9W	79	C16984B	65	DF1207FP000	24	DF1504FRA00	23
ABB520P5W	77	C16984C	65	DF1207FRAB0	23	DF1504FR0E0	23
ABB520P5W	79	C16984D	65	DF1207FRA00	23	DF1504FR000	23
ABB520P7W	77	CLF20-100	80	DF1207FR0E0	23	DF1514FP000	22
ABB520P7W	79	DAA10	36	DF1207FR000	23	DF1514FP000	24
ABB520P9W	77	DAA20	36	DF1214FP000	22	DF1514FRAB0	23
ABB520P9W	79	DAA40	36	DF1214FP000	24	DF1514FRA00	23
ABB520R5W	77	DBRE120710000	48	DF1214FRAB0	23	DF1514FR0E0	23
ABB520R7W	77	DBRE130710000	48	DF1214FRA00	23	DF1514FR000	23
ABB520R9W	77	DBRE140410000	48	DF1214FR0E0	23	DF1516FP000	22
ABB530B5W	77	DBRE150410000	48	DF1214FR000	23	DF1516FP000	24
ABB530B7W	77	DBRE310703000	48	DF1216FP000	22	DF1516FRAB0	23
ABB530B9W	77	DBRE320703000	48	DF1216FP000	24	DF1516FRA00	23
ABB530C5W	77	DBRE330703000	48	DF1216FRAB0	23	DF1516FR0E0	23
ABB530C7W	77	DBRE340403000	48	DF1216FRA00	23	DF1516FR000	23
ABB530C9W	77	DBRE350403000	48	DF1216FR0E0	23	DF1521FP000	22
ABB530MF5W	79	DBRE620706000	48	DF1216FR000	23	DF1521FP000	24
ABB530MF7W	79	DBRE630706000	48	DF1304FP000	22	DF1521FRAB0	23
ABB530MI5W	79	DBRE640406000	48	DF1304FP000	24	DF1521FRA00	23
ABB530MI7W	79	DBRE650406000	48	DF1304FRAB0	23	DF1521FR0E0	23
ABB530MI9W	79	DBRS120710000	45	DF1304FRA00	23	DF1521FR000	23
ABB530P5W	77	DBRS130710000	45	DF1304FR0E0	23	DF2020	34
ABB530P5W	79	DBRS140410000	45	DF1304FR000	23	DF2022	34
ABB530P7W	77	DBRS150410000	45	DF1307FP000	37	DF2024	34
ABB530P7W	79	DBRS230720000	45	DF1307FP000	22	DF2026	34
ABB530P9W	77	DBRS240420000	45	DF1307FP000	24	DF2027	34
ABB530P9W	79	DBRS250420000	45	DF1307FRAB0	23	DF2029	34
ABB530R5W	77	DBRS310703000	45	DF1307FRA00	23	DF2032	34
ABB530R7W	77	DBRS320703000	45	DF1307FR0E0	23	DF2034	34
ABB530R9W	77	DBRS330703000	45	DF1307FR000	23	DF2036	34
ABB532B6W	77	DBRS340403000	45	DF1316FP000	22	DF2040	34
ABB532C6W	77	DBRS350403000	45	DF1316FP000	24	DF2104FP000	26
ABB532P6W	77	DBRS430740000	45	DF1316FRAB0	23	DF2104FP000	28
ABB532R6W	77	DBRS440440000	45	DF1316FRA00	23	DF2104FRAB0	27
ABB560B5W	78	DBRS450440000	45	DF1316FR0E0	23	DF2104FRA00	27
ABB560B7W	78	DBRS620706000	45	DF1316FR000	23	DF2104FR000	27
ABB560B9W	78	DBRS630706000	45	DF1404FP000	37	DF2107FP000	26
ABB560C5W	78	DBRS640406000	45	DF1404FP000	22	DF2107FP000	28
ABB560C7W	78	DBRS650406000	45	DF1404FP000	24	DF2107FRAB0	27
ABB560C9W	78	DCCA10	36	DF1404FRAB0	23	DF2107FRA00	27
ABB560MF9W	79	DCCA20	36	DF1404FRA00	23	DF2107FR000	27
ABB560MI5W	79	DCCA3	36	DF1404FR0E0	23	DF2204FP000	26

Catalog Number Index

CAT. NO.	PAGE NO.	CAT. NO.	PAGE NO.	CAT. NO.	PAGE NO.	CAT. NO.	PAGE NO.
DF2204FP000	28	DF2514FR000	27	DF3404FRAB0	15	DF4204FR000	31
DF2204FRAB0	27	DF2516FP000	26	DF3404FRA00	15	DF4207FP000	30
DF2204FRA00	27	DF2516FP000	28	DF3404FR0E0	15	DF4207FP000	32
DF2204FR000	27	DF2516FRAB0	27	DF3404FR000	15	DF4207FRAB0	31
DF2207FP000	26	DF2516FRA00	27	DF3407FP000	14	DF4207FRA00	31
DF2207FP000	28	DF2516FR000	27	DF3407FR000	16	DF4207FR000	31
DF2207FRAB0	27	DF2521FP000	26	DF3407FRAB0	15	DF4214FP000	30
DF2207FRA00	27	DF2521FP000	28	DF3407FRA00	15	DF4214FP000	32
DF2207FR000	27	DF2521FRAB0	27	DF3407FR0E0	15	DF4214FRAB0	31
DF2214FP000	26	DF2521FRA00	27	DF3407FR000	15	DF4214FRA00	31
DF2214FRAB0	28	DF2521FR000	27	DF3414FP000	14	DF4214FR000	31
DF2214FRA00	27	DF3104FP000	14	DF3414FP000	16	DF4216FP000	30
DF2214FR000	27	DF3104FP000	16	DF3414FRAB0	15	DF4216FP000	32
DF2216FP000	26	DF3104FRAB0	15	DF3414FRA00	15	DF4216FRAB0	31
DF2216FP000	28	DF3104FRA00	15	DF3414FR0E0	15	DF4216FRA00	31
DF2216FRAB0	27	DF3104FR0E0	15	DF3414FR000	15	DF4216FR000	31
DF2216FRA00	27	DF3104FR000	14	DF3416FP000	14	DF4304FP000	37
DF2216FR000	27	DF3107FP000	37	DF3416FP000	16	DF4304FP000	30
DF2304FP000	37	DF3107FP000	14	DF3416FRAB0	15	DF4304FP000	32
DF2304FRAB0	26	DF3107FRAB0	16	DF3416FRA00	15	DF4304FRAB0	31
DF2304FRA00	28	DF3107FR0E0	15	DF3416FR0E0	15	DF4304FRA00	31
DF2304FR000	27	DF3107FR000	15	DF3416FR000	15	DF4304FR000	31
DF2307FP000	26	DF3204FP000	14	DF3421FP000	14	DF4307FP000	30
DF2307FRAB0	27	DF3204FP000	16	DF3421FR0E0	16	DF4307FP000	32
DF2307FRA00	27	DF3204FRAB0	15	DF3421FRA00	15	DF4307FRAB0	31
DF2307FR000	27	DF3204FRA00	15	DF3421FR0E0	15	DF4307FRA00	31
DF2316FP000	26	DF3204FR0E0	15	DF3421FR000	15	DF4307FR000	31
DF2316FRAB0	28	DF3204FR000	15	DF3421MRAB0	15	DF4316FP000	30
DF2316FRAB0	27	DF3207FP000	37	DF3504FP000	37	DF4316FP000	32
DF2316FRA00	27	DF3207FP000	14	DF3504FRAB0	14	DF4316FRAB0	31
DF2316FR000	27	DF3207FRAB0	16	DF3504FRA00	15	DF4316FR000	31
DF2404FP000	37	DF3207FR0E0	15	DF3504FR000	15	DF4404FP000	37
DF2404FRAB0	26	DF3207FR000	15	DF3504FR0E0	15	DF4404FP000	30
DF2404FR000	28	DF3214FP000	14	DF3504FR000	15	DF4404FP000	32
DF2404FRA00	27	DF3214FP000	16	DF3514FP000	14	DF4404FRAB0	31
DF2404FR000	27	DF3214FRAB0	15	DF3514FR0E0	16	DF4404FRA00	31
DF2407FP000	26	DF3214FRA00	15	DF3514FR000	15	DF4404FR000	31
DF2407FRAB0	28	DF3214FR0E0	15	DF3514FR0E0	15	DF4407FP000	30
DF2407FRA00	27	DF3214FR000	15	DF3514FR000	15	DF4407FP000	32
DF2407FR000	27	DF3216FP000	14	DF3516FP000	16	DF4407FRAB0	31
DF2414FP000	26	DF3216FP000	15	DF3516FRAB0	15	DF4407FRA00	31
DF2414FRAB0	27	DF3216FRAB0	15	DF3516FRA00	15	DF4407FR000	31
DF2414FRA00	27	DF3216FR0E0	15	DF3516FR0E0	15	DF4414FP000	30
DF2414FR000	27	DF3216FR000	15	DF3516FR000	15	DF4414FP000	32
DF2416FP000	26	DF3304FP000	14	DF3521FP000	16	DF4414FRAB0	31
DF2416FRAB0	27	DF3304FRAB0	16	DF3521FR0E0	16	DF4414FRA00	31
DF2416FRA00	27	DF3304FR0E0	15	DF3521FR000	15	DF4416FP000	30
DF2416FR000	26	DF3307FP000	37	DF4042	34	DF4416FP000	32
DF2421FP000	28	DF3307FP000	14	DF4044	34	DF4416FRAB0	31
DF2421FRAB0	27	DF3307FRAB0	16	DF4048	34	DF4416FRA00	31
DF2421FRA00	27	DF3307FR0E0	15	DF4054	34	DF4421FP000	30
DF2421FR000	27	DF3307FR000	15	DF4104FP000	30	DF4421FP000	32
DF2504FP000	37	DF3316FP000	14	DF4104FRAB0	31	DF4421FRAB0	31
DF2504FRAB0	26	DF3316FP000	16	DF4104FRA00	31	DF4421FRA00	31
DF2504FR000	28	DF3316FRAB0	15	DF4104FR0E0	31	DF4504FP000	37
DF2504FRA00	27	DF3316FR0E0	15	DF4107FP000	30	DF4504FP000	30
DF2504FR000	27	DF3316FR000	14	DF4107FRAB0	32	DF4504FP000	32
DF2514FP000	26	DF3316FR0E0	15	DF4107FRA00	31	DF4504FRAB0	31
DF2514FR000	28	DF3316FR000	15	DF4107FR0E0	31	DF4504FRA00	31
DF2514FRAB0	27	DF3404FP000	37	DF4204FP000	30	DF4514FP000	30
DF2514FRA00	27	DF3404FRAB0	14	DF4204FRAB0	31	DF4514FR000	32
DF2514FR000	27	DF3404FR000	16	DF4204FRA00	31	DF4514FRAB0	31
						DF4514FRA00	31
						DF4514FR000	31
						DF4516FP000	30
						DF4516FP000	32

Catalog Number Index

CAT. NO.	PAGE NO.	CAT. NO.	PAGE NO.	CAT. NO.	PAGE NO.	CAT. NO.	PAGE NO.
DF4516FRAB0	31	DF6407FP000	18	DFPU3207	37	DS1207MP000	45
DF4516FRA00	31	DF6407FP000	20	DFPU3307	37	DS1207MP000	48
DF4516FR000	31	DF6407FRAB0	19	DFPU3404	37	DS1207MP000	22
DF4521FP000	30	DF6407FRA00	19	DFPU3504	37	DS1207MP000	24
DF4521FR000	32	DF6407FR0E0	19	DFPU4304	37	DS1207MRAB0	25
DF4521FRAB0	31	DF6407FR000	19	DFPU4404	37	DS1207MRA00	25
DF4521FRA00	31	DF6414FP000	18	DFPU4504	37	DS1207MR0E0	25
DF4521FR000	31	DF6414FR000	20	DFPU6207	37	DS1207MR000	25
DF6104FP000	18	DF6414FRAB0	19	DFPU6307	37	DS1214MP000	22
DF6104FRA00	20	DF6414FRA00	19	DFPU6404	37	DS1214MP000	24
DF6104FR0E0	19	DF6414FR0E0	19	DFPU6504	37	DS1214MRAB0	25
DF6104FR000	19	DF6414FR000	19	DFRF12070	44	DS1214MRA00	25
DF6104FR000	19	DF6416FP000	18	DFRF13070	44	DS1214MR0E0	25
DF6107FP000	18	DF6416FP000	20	DFRF14040	44	DS1214MR000	25
DF6107FR0E0	20	DF6416FRA00	19	DFRF15040	44	DS1216MP000	22
DF6107FRAB0	19	DF6416FRA00	19	DFRF31070	44	DS1216MP000	24
DF6107FRA00	19	DF6416FR0E0	19	DFRF32070	44	DS1216MRAB0	25
DF6107FR0E0	19	DF6416FR000	19	DFRF33070	44	DS1216MRA00	25
DF6107FR000	19	DF6421FP000	18	DFRF34040	44	DS1216MR0E0	25
DF6204FP000	18	DF6421FP000	20	DFRF35040	44	DS1216MR000	25
DF6204FP000	20	DF6421FRA00	19	DFRF62070	44	DS1304MP000	22
DF6204FRA00	19	DF6421FRA00	19	DFRF63070	44	DS1304MP000	24
DF6204FR0E0	19	DF6421FR0E0	19	DFRF64040	44	DS1304MRAB0	25
DF6204FR000	19	DF6421FR000	19	DFRF65040	44	DS1304MRA00	25
DF6207FP000	37	DF6504FP000	37	DFRU1207	37	DS1304MR0E0	25
DF6207FP000	18	DF6504FP000	18	DFRU1307	37	DS1304MR000	25
DF6207FP000	20	DF6504FRA00	19	DFRU1404	37	DS1307MP000	37
DF6207FRA00	19	DF6504FRA00	19	DFRU1504	37	DS1307MP000	44
DF6207FR0E0	19	DF6504FR0E0	19	DFRU2304	37	DS1307MP000	45
DF6207FR000	19	DF6504FR000	19	DFRU2404	37	DS1307MP000	48
DF6207FR000	19	DF6514FP000	18	DFRU2504	37	DS1307MP000	22
DF6214FP000	18	DF6514FP000	20	DFRU3107	37	DS1307MP000	24
DF6214FRA00	19	DF6514FRA00	19	DFRU3207	37	DS1307MRAB0	25
DF6214FR0E0	19	DF6514FR0E0	19	DFRU3307	37	DS1307MRA00	25
DF6214FR000	19	DF6514FR000	19	DFRU3404	37	DS1307MR0E0	25
DF6216FP000	18	DF6516FP000	18	DFRU3504	37	DS1307MR000	25
DF6216FP000	20	DF6516FP000	20	DFRU4304	37	DS1316MP000	22
DF6216FRA00	19	DF6516FRA00	19	DFRU4404	37	DS1316MP000	24
DF6216FR0E0	19	DF6516FR0E0	19	DFRU4504	37	DS1316MRAB0	25
DF6216FR000	19	DF6521FP000	18	DFRU6207	37	DS1316MRA00	25
DF6304FP000	18	DF6521FP000	20	DFRU6307	37	DS1316MR0E0	25
DF6304FRA00	20	DF6521FRA00	19	DFRU6404	37	DS1316MR000	25
DF6304FRAB0	19	DF6521FR0E0	19	DFRU6504	37	DS1404MP000	37
DF6304FRA00	19	DF6521FR000	19	DJB20	36	DS1404MP000	44
DF6304FR0E0	19	DFA14	35	DJB40	36	DS1404MP000	45
DF6304FR000	19	DFA15	35	DRA10	36	DS1404MP000	48
DF6307FP000	37	DFA16	35	DRA20	36	DS1404MP000	22
DF6307FP000	18	DFA25	35	DRA40	36	DS1404MP000	24
DF6307FP000	20	DFA26	35	DRCA10	36	DS1404MRAB0	25
DF6307FRA00	19	DFA27	35	DRCA3	36	DS1404MRA00	25
DF6307FRA00	19	DFA46	35	DRCA6	36	DS1404MR0E0	25
DF6307FR0E0	19	DFA47	35	DS1104MP000	22	DS1404MR000	25
DF6307FR000	19	DFA48	35	DS1104MP000	24	DS1407MP000	22
DF6316FP000	18	DFC10	35	DS1104MRAB0	25	DS1407MP000	24
DF6316FP000	20	DFC20	35	DS1104MRA00	25	DS1407MRAB0	25
DF6316FRAB0	19	DFC3	35	DS1104MR0E0	25	DS1407MRA00	25
DF6316FRA00	19	DFC40	35	DS1104MR000	25	DS1407MR0E0	25
DF6316FR0E0	19	DFC6	35	DS1107MP000	22	DS1407MR000	25
DF6316FR000	19	DFPU1207	37	DS1107MP000	24	DS1414MP000	22
DF6404FP000	37	DFPU1307	37	DS1107MRAB0	25	DS1414MP000	24
DF6404FP000	18	DFPU1404	37	DS1107MRA00	25	DS1414MRAB0	25
DF6404FP000	20	DFPU1504	37	DS1107MR0E0	25	DS1414MRA00	25
DF6404FRA00	19	DFPU2304	37	DS1107MR000	25	DS1414MR0E0	25
DF6404FRA00	19	DFPU2404	37	DS1204MP000	22	DS1414MR000	25
DF6404FR0E0	19	DFPU2504	37	DS1204MP000	24	DS1416MP000	22
DF6404FR000	19	DFPU3107	37	DS1204MRAB0	25	DS1416MP000	24
				DS1204MRA00	25	DS1416MRAB0	25
				DS1204MR0E0	25	DS1416MRA00	25
				DS1204MR000	25	DS1416MR0E0	25
				DS1207MP000	37	DS1416MR000	25
				DS1207MP000	44	DS1421MP000	22

Catalog Number Index

CAT. NO.	PAGE NO.	CAT. NO.	PAGE NO.	CAT. NO.	PAGE NO.	CAT. NO.	PAGE NO.
DS1421MP000	24	DS2307MP000	26	DS3107MP000	16	DS3414MP000	14
DS1421MRAB0	25	DS2307MP000	28	DS3107MRAB0	17	DS3414MP000	16
DS1421MRA00	25	DS2307MRAB0	29	DS3107MRA00	17	DS3414MRAB0	17
DS1421MR0E0	25	DS2307MRA00	29	DS3107MR0E0	17	DS3414MRA00	17
DS1421MR000	25	DS2307MR000	29	DS3107MR000	17	DS3414MR0E0	17
DS1504MP000	37	DS2316MP000	26	DS3204MP000	14	DS3414MR000	17
DS1504MP000	44	DS2316MP000	28	DS3204MP000	16	DS3416MP000	14
DS1504MP000	45	DS2316MRAB0	29	DS3204MRAB0	17	DS3416MP000	16
DS1504MP000	48	DS2316MRA00	29	DS3204MRA00	17	DS3416MRAB0	17
DS1504MP000	22	DS2316MR000	29	DS3204MR0E0	17	DS3416MRA00	17
DS1504MP000	24	DS2404MP000	37	DS3204MR000	17	DS3416MR0E0	17
DS1504MRAB0	25	DS2404MP000	45	DS3207MP000	37	DS3416MR000	17
DS1504MRA00	25	DS2404MP000	26	DS3207MP000	44	DS3421MP000	14
DS1504MR0E0	25	DS2404MP000	28	DS3207MP000	45	DS3421MP000	16
DS1504MR000	25	DS2404MRAB0	29	DS3207MP000	48	DS3421MRAB0	17
DS1514MP000	22	DS2404MRA00	29	DS3207MP000	14	DS3421MRA00	17
DS1514MP000	24	DS2404MR000	29	DS3207MP000	16	DS3421MR0E0	17
DS1514MRAB0	25	DS2407MP000	26	DS3207MRAB0	17	DS3421MR000	17
DS1514MRA00	25	DS2407MP000	28	DS3207MRA00	17	DS3504MP000	37
DS1514MR0E0	25	DS2407MRAB0	29	DS3207MR0E0	17	DS3504MP000	44
DS1514MR000	25	DS2407MRA00	29	DS3207MR000	17	DS3504MP000	45
DS1516MP000	22	DS2407MR000	29	DS3214MP000	14	DS3504MP000	48
DS1516MP000	24	DS2414MP000	26	DS3214MP000	16	DS3504MP000	14
DS1516MRAB0	25	DS2414MP000	28	DS3214MRAB0	17	DS3504MP000	16
DS1516MRA00	25	DS2414MRAB0	29	DS3214MRA00	17	DS3504MRAB0	17
DS1516MR0E0	25	DS2414MRA00	29	DS3214MR0E0	17	DS3504MRA00	17
DS1516MR000	25	DS2414MR000	29	DS3214MR000	17	DS3504MR0E0	17
DS1521MP000	22	DS2416MP000	26	DS3216MP000	14	DS3504MR000	17
DS1521MP000	24	DS2416MP000	28	DS3216MP000	16	DS3514MP000	14
DS1521MRAB0	25	DS2416MRAB0	29	DS3216MRAB0	17	DS3514MP000	16
DS1521MRA00	25	DS2416MRA00	29	DS3216MRA00	17	DS3514MRAB0	17
DS1521MR0E0	25	DS2416MR000	29	DS3216MR0E0	17	DS3514MRA00	17
DS1521MR000	25	DS2421MP000	26	DS3216MR000	17	DS3514MR0E0	17
DS1CC	36	DS2421MP000	28	DS3304MP000	14	DS3514MR000	17
DS2104MP000	26	DS2421MRAB0	29	DS3304MP000	16	DS3516MP000	14
DS2104MP000	28	DS2421MRA00	29	DS3304MRAB0	17	DS3516MP000	16
DS2104MRAB0	29	DS2421MR000	29	DS3304MRA00	17	DS3516MRAB0	17
DS2104MRA00	29	DS2504MP000	37	DS3304MR0E0	17	DS3516MRA00	17
DS2104MR000	29	DS2504MP000	45	DS3304MR000	17	DS3516MR0E0	17
DS2107MP000	26	DS2504MP000	26	DS3307MP000	37	DS3516MR000	17
DS2107MP000	28	DS2504MP000	28	DS3307MP000	44	DS3521MP000	14
DS2107MRAB0	29	DS2504MRAB0	29	DS3307MP000	45	DS3521MP000	16
DS2107MRA00	29	DS2504MRA00	29	DS3307MP000	48	DS3521MRAB0	17
DS2107MR000	29	DS2504MR000	29	DS3307MP000	14	DS3521MRAB0	17
DS2204MP000	26	DS2514MP000	26	DS3307MP000	16	DS3521MR0E0	17
DS2204MP000	28	DS2514MP000	28	DS3307MRAB0	17	DS3521MR000	17
DS2204MRAB0	29	DS2514MRAB0	29	DS3307MRAB0	17	DS3CC	36
DS2204MRA00	29	DS2514MRA00	29	DS3307MR0E0	17	DS4104MP000	30
DS2204MR000	29	DS2514MR000	29	DS3307MR000	17	DS4104MP000	32
DS2207MP000	26	DS2516MP000	26	DS3316MP000	14	DS4104MRAB0	33
DS2207MP000	28	DS2516MP000	28	DS3316MP000	16	DS4104MRA00	33
DS2207MRAB0	29	DS2516MP000	28	DS3316MRAB0	17	DS4104MR000	33
DS2207MRA00	29	DS2516MRAB0	29	DS3316MRAB0	17	DS4107MP000	30
DS2207MR000	29	DS2516MRA00	29	DS3316MR0E0	17	DS4107MP000	32
DS2214MP000	26	DS2516MR000	29	DS3316MR000	17	DS4107MRAB0	33
DS2214MP000	28	DS2521MP000	26	DS3316MR000	17	DS4107MRA00	33
DS2214MRAB0	29	DS2521MP000	37	DS3404MP000	37	DS4107MR000	33
DS2214MRA00	29	DS2521MRAB0	29	DS3404MP000	44	DS4204MP000	30
DS2214MR000	29	DS2521MRA00	29	DS3404MP000	45	DS4204MP000	32
DS2216MP000	26	DS2521MR000	29	DS3404MP000	48	DS4204MP000	32
DS2216MP000	28	DS2CC	36	DS3404MP000	14	DS4204MRAB0	33
DS2216MRAB0	29	DS3104MP000	14	DS3404MP000	16	DS4204MRA00	33
DS2216MRA00	29	DS3104MP000	16	DS3404MP000	17	DS4204MR000	33
DS2216MR000	29	DS3104MRAB0	17	DS3404MRAB0	17	DS4207MP000	30
DS2304MP000	37	DS3104MRA00	17	DS3404MR0E0	17	DS4207MP000	32
DS2304MP000	26	DS3104MR0E0	17	DS3404MR000	17	DS4207MRAB0	33
DS2304MP000	28	DS3104MR000	17	DS3407MP000	14	DS4207MRA00	33
DS2304MRAB0	29	DS3107MP000	37	DS3407MP000	16	DS4207MR000	33
DS2304MRA00	29	DS3107MP000	44	DS3407MP000	16	DS4214MP000	30
DS2304MR000	29	DS3107MP000	45	DS3407MRAB0	17	DS4214MP000	32
DS2307MP000	45	DS3107MP000	48	DS3407MRA00	17	DS4214MRAB0	33
		DS3107MP000	14	DS3407MR0E0	17	DS4214MRA00	33
		DS3107MP000	14	DS3407MR000	17		

Catalog Number Index

CAT. NO.	PAGE NO.	CAT. NO.	PAGE NO.	CAT. NO.	PAGE NO.	CAT. NO.	PAGE NO.
DS4214MR000	33	DS4521MR000	33	DS6404MRA00	21	F34754B	37
DS4216MP000	30	DS4CC	36	DS6404MR0E0	21	F34754B	37
DS4216MP000	32	DS6104MP000	18	DS6404MR000	21	F34755A	37
DS4216MRAB0	33	DS6104MP000	20	DS6407MP000	18	F34755B	37
DS4216MRA00	33	DS6104MRAB0	21	DS6407MP000	20	F34755C	37
DS4216MR000	33	DS6104MRA00	21	DS6407MRAB0	21	F34756A	37
DS4304MP000	37	DS6104MR0E0	21	DS6407MRA00	21	F34756B	37
DS4304MP000	30	DS6104MR000	21	DS6407MR0E0	21	F34756B	37
DS4304MP000	32	DS6107MP000	18	DS6407MR000	21	F34756C	37
DS4304MRAB0	33	DS6107MP000	20	DS6414MP000	18	F34757	37
DS4304MRA00	33	DS6107MRAB0	21	DS6414MP000	20	F34757	37
DS4304MR000	33	DS6107MRA00	21	DS6414MRAB0	21	F34757	37
DS4307MP000	45	DS6107MR0E0	21	DS6414MRA00	21	F34758	37
DS4307MP000	30	DS6107MR000	21	DS6414MR0E0	21	GC1	51
DS4307MP000	32	DS6204MP000	18	DS6414MR000	21	GCC1	51
DS4307MRAB0	33	DS6204MP000	20	DS6416MP000	18	GSUL2SS	52
DS4307MRA00	33	DS6204MRAB0	21	DS6416MP000	20	GSUL2SS-240	52
DS4307MR000	33	DS6204MRA00	21	DS6416MRAB0	21	GX24RCB	52
DS4316MP000	30	DS6204MR0E0	21	DS6416MRA00	21	GX2TK	52
DS4316MP000	32	DS6204MR000	21	DS6416MR0E0	21	JAA10	36
DS4316MRAB0	33	DS6207MP000	37	DS6416MR000	21	JAA10-45	36
DS4316MRA00	33	DS6207MP000	44	DS6421MP000	18	JAA6-45	36
DS4316MR000	33	DS6207MP000	45	DS6421MP000	20	JAA6-AB6	36
DS4404MP000	37	DS6207MP000	48	DS6421MRAB0	21	JB10-B150	36
DS4404MP000	45	DS6207MP000	18	DS6421MRA00	21	JB10-B200	36
DS4404MP000	30	DS6207MP000	20	DS6421MR0E0	21	JB6-1	36
DS4404MP000	32	DS6207MRAB0	21	DS6421MR000	21	JE10	36
DS4404MRAB0	33	DS6207MRA00	21	DS6504MP000	37	JE10M	36
DS4404MRA00	33	DS6207MR0E0	21	DS6504MP000	44	JE6	36
DS4404MR000	33	DS6207MR000	21	DS6504MP000	45	JFA10	36
DS4407MP000	30	DS6214MP000	18	DS6504MP000	48	JFA10	36
DS4407MP000	32	DS6214MP000	20	DS6504MP000	18	JFA20	36
DS4407MRAB0	33	DS6214MRAB0	21	DS6504MP000	20	JFA6	36
DS4407MRA00	33	DS6214MRA00	21	DS6504MRAB0	21	JG1010	34
DS4407MR000	33	DS6214MR0E0	21	DS6504MRA00	21	JG1011	34
DS4414MP000	30	DS6214MR000	21	DS6504MR0E0	21	JG1013	34
DS4414MP000	32	DS6216MP000	18	DS6504MR000	21	JG104	34
DS4414MRAB0	33	DS6216MP000	20	DS6514MP000	18	JG105	34
DS4414MRA00	33	DS6216MRAB0	21	DS6514MP000	20	JG106	34
DS4414MR000	33	DS6216MRA00	21	DS6514MRAB0	21	JG107	34
DS4416MP000	30	DS6216MR0E0	21	DS6514MRA00	21	JG108	34
DS4416MP000	32	DS6216MR000	21	DS6514MR0E0	21	JG610	34
DS4416MRAB0	33	DS6304MP000	18	DS6514MR000	21	JG63	34
DS4416MRA00	33	DS6304MP000	20	DS6516MP000	18	JG64	34
DS4416MR000	33	DS6304MRAB0	21	DS6516MP000	20	JG65	34
DS4421MP000	30	DS6304MRA00	21	DS6516MRAB0	21	JG66	34
DS4421MP000	32	DS6304MR0E0	21	DS6516MRA00	21	JG67	34
DS4421MRAB0	33	DS6304MR000	21	DS6516MR0E0	21	JG69	34
DS4421MRA00	33	DS6307MP000	37	DS6516MR000	21	JPA 106	35
DS4421MR000	33	DS6307MP000	44	DS6521MP000	18	JPA104	35
DS4504MP000	37	DS6307MP000	45	DS6521MP000	20	JPA105	35
DS4504MP000	45	DS6307MP000	48	DS6521MRAB0	21	JPA62	35
DS4504MP000	30	DS6307MP000	18	DS6521MRA00	21	JPA63	35
DS4504MP000	32	DS6307MP000	20	DS6521MR0E0	21	JPA64	35
DS4504MRAB0	33	DS6307MRAB0	21	DS6521MR000	21	JPA65	35
DS4504MRA00	33	DS6307MRA00	21	DS6CC	36	JRA10	36
DS4504MR000	33	DS6307MR0E0	21	DSC10	35	JRA6-AB6	36
DS4514MP000	30	DS6307MR000	21	DSC20	35	N-R1-G	40
DS4514MP000	32	DS6316MP000	18	DSC3	35	N-R1-S2-G	40
DS4514MRAB0	33	DS6316MP000	20	DSC40	35	N-R1-S2-T3-G	40
DS4514MRA00	33	DS6316MRAB0	21	DSC6	35	R1-S2-G	40
DS4514MR000	33	DS6316MRA00	21	DSE3107FR0	48	R1-S2-T3-G	40
DS4516MP000	30	DS6316MR0E0	21	DSE3207FR0	48	SGC2	52
DS4516MP000	32	DS6316MR000	21	DSE3307FR0	48	SGR25	52
DS4516MRAB0	33	DS6404MP000	37	DSE3404FR0	48	SGR50	52
DS4516MRA00	33	DS6404MP000	44	DSE3504FR0	48	SGR75	52
DS4516MR000	33	DS6404MP000	45	ELAG	52		
DS4521MP000	30	DS6404MP000	48	F06146	51		
DS4521MP000	32	DS6404MP000	18	F30602	52		
DS4521MRAB0	33	DS6404MP000	20	F30674	52		
DS4521MRA00	33	DS6404MRAB0	21	F34754A	37		

A Global Leader in Innovative...

Wire & Cable Management

Carlton® *Catamount*® *EZCODE*® *Kindorf*® *redodot*®
Steel City® *Superstrut*® *T&B Cable Tray* *Ty-Duct*® *Ty-Rap*®



Cable Protection Systems

Adaptaflex® **Carlton**® *Harnessflex*® *KOPEX-EX*® *Ocal*®
PMA® *redodot*® *Steel City*® *T&B Fittings*®



Power Connection & Control

Blackburn® **CYBEREX**® *elastimold*® **FISHER PIERCE**®
Hi-Tech® **HOMAC**® *JENNINGS* TECHNOLOGY® **JOSLYN**®
Pos-E-Kon® *Russellstoll*® *Sta-Kon*®



Safety Technology

AMERACE® **Current Technology**® **EMERGI-LITE**®
Hazlux® **JOSLYN**® *Lightalarms*®



Thomas & Betts

A Member of the ABB Group

www.tnb.com

Visit our world of electrical product solutions

Visit the "Electrical World" section of our web site at www.tnb.com for more information on Thomas & Betts solutions including our newest products, plus user-friendly catalog and competitive part number search, application and technical support and other useful information. Click on the Electrical World icon or go to: tnbelectricalworld.tnb.com.

Industry codes and specifications

Thomas & Betts products meet or exceed applicable industry specifications or codes which are detailed in the appropriate T&B product literature.



Online CAD library

Thomas & Betts offers free download of two- and three-dimensional CAD models of many of its products in more than 90 native CAD formats at: www.tnb.com/cadlibrary.

Thomas & Betts Corporation

8155 T&B Boulevard
Memphis, TN 38125
901.252.8000

www.tnb.com

United States

Thomas & Betts Corporation
Electrical Division Headquarters
8155 T&B Boulevard
Memphis, TN 38125
Phone: 901.252.8000
Fax: 800.816.7810
Technical Services:
888.862.3289
Email: techsupport@tnb.com

Canada

Thomas & Betts Ltd
700 Avenue Thomas
St.-Jean-sur-Richelieu, Quebec
J2X 2M9
Phone: 450.347.5318
Fax: 450.347.1976

Latin America

Mexico: 01-800-TNB-HELP
Central America & Caribbean:
+52.81.8329.7707
South America:
+52.81.8329.7743
Email: servicioclientes@tnb.com

Europe/Africa

T&B European Centre
200 Chaussée de Waterloo
B-1640 Rhode-St-Genèse
Belgium
Phone: +32.235.98200
Email: europe_inquiry@tnb.com

Middle East

Thomas & Betts Ltd
PO Box 54567
Dubai Airport Free Zone Bldg.
Office 724 6WA West Wing
Dubai
United Arab Emirates
Phone: +9714 6091635
Fax: +9714 6091636
Email: enquiryME@tnb.com

Asia Pacific

Thomas & Betts Asia Pte Ltd
10 Ang Mo Kio Street 65
#06-07 Techpoint
Singapore 569059
Phone: +65.6720.8828
Fax: +65.6720.8780
Email: asia_inquiry@tnb.com

American Recovery and Reinvestment Act (ARRA)



Get certification letters for
compliant products online at:

www.tnb.com/ARRA